



Digital – in the vehicle

Explore the Operator's Manual in the multimedia system under Preferences. Begin with Quick Start and discover useful tips.



Vehicle document wallet

This contains a physical copy of comprehensive information about operating your vehicle and about services and your vehicle's warranty



1675841931

Order no. P167 1044 13 Part no. 167 584 19 31
Edition A 2025

GLE Coupe



Mercedes-Benz

GLE Coupe

Operator's Manual

Mercedes-Benz



Front passenger air bag warning

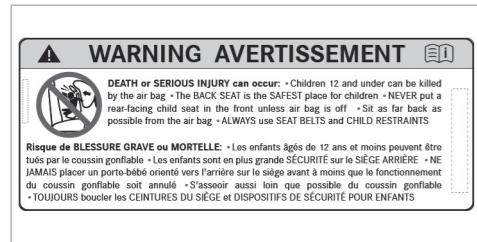
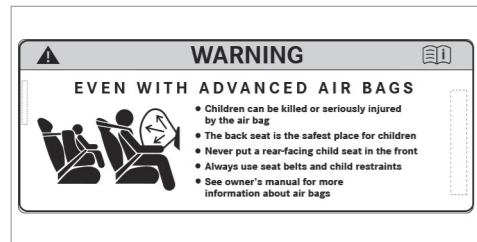

Air bag warning sticker for USA and Canada

⚠ WARNING Risk of injury or fatal injuries if the front passenger air bag is enabled

If the front passenger air bag is enabled, a child on the front passenger seat may be struck by the front passenger air bag in the event of an accident.

▶ NEVER use a rearward-facing child restraint system on a seat with an ENABLED FRONT AIR BAG. This can result in the DEATH of or SERIOUS INJURY to the CHILD.

Observe the chapter "Children in the vehicle".

Publication details

Website

Further information about Mercedes-Benz vehicles and about Mercedes-Benz AG can be found on the following websites:

<https://www.mbusa.com> (USA only)

<https://www.mercedes-benz.ca> (Canada only)

Editorial team

© Mercedes-Benz AG: Not to be reprinted, translated or otherwise reproduced, in whole or in part, without written permission from Mercedes-Benz AG.

Vehicle manufacturer

Mercedes-Benz AG

Mercedesstraße 120

70372 Stuttgart, Germany

Welcome to the world of Mercedes-Benz

Before your first drive, please read this Operator's Manual carefully and familiarize yourself with your vehicle. For your own safety and a longer service life for the vehicle, follow the instructions and warning notes in this Operator's Manual. Failure to do so may lead to personal injury or damage to the vehicle.

Vehicle damage caused by failure to observe the instructions is not covered by the Mercedes-Benz Limited Warranty.

The standard equipment and product description of your vehicle may vary and depends on the following factors:

- Model
- Order
- National version
- Availability

In individual cases, your vehicle may therefore differ from that shown in the descriptions and illustrations.

Mercedes-Benz reserves the right to introduce changes in the following areas:

- Design
- Equipment
- Technical features

The following documents are components of the vehicle:

- Digital Operator's Manual
- Printed Operator's Manual
- Maintenance Booklet (USA only)
- Supplementary manuals relating to specific equipment
- Supplementary documents

Keep these documents in the vehicle at all times. Ensure that all documents are in the vehicle or passed on in the event of sale or rental.

The latest information on service and warranty, along with a digital copy of this Operator's Manual, can be found on the following website.

USA only:

<https://www.mbusa.com/en/vehicle-information>

Canada only:

<https://www.mercedes-benz.ca/en/owners/manuals> (English)

<https://www.mercedes-benz.ca/fr/owners/manuals> (French)

Mercedes-Benz USA, LLC

Mercedes-Benz Canada, Inc.

A Mercedes-Benz Group AG Company

Symbols	5	Installing the license plate on the front license plate bracket	30	Airbags	57
At a glance	6	National information for components relevant to radio regulation	30	Children in the vehicle	58
Cockpit	6	Diagnostics connection	31	Key facts in brief	58
Indicator and warning lamps	10	Qualified specialist workshop	32	Important safety notes	58
Overhead control panel	14	Correct use of the vehicle	32	Suitable child restraint systems for the transport of children	64
Door operating unit and seat adjustment	16	Sport Utility Vehicle	32	Securing the child restraint system	64
Control settings in the rear passenger compartment	18	Notes for persons with electronic medical aids	33	Child safety locks	70
Emergencies and breakdowns	20	Problems with your vehicle	34	Occupant presence reminder	72
Digital Operator's Manual	22	Reporting safety defects	34	Opening and closing	73
Calling up the Digital Operator's Manual	22	Limited Warranty	35	SmartKey	73
General notes	23	QR code for rescue card	35	Doors	77
Environmental protection	23	Data storage	35	Cargo compartment	81
Mercedes-Benz GenuineParts	23	Copyright	40	Side windows	87
Operator's Manual	24	Occupant safety	41	Sliding sunroof	90
Touch-sensitive controls	25	Brief overview of the most important points	41	Anti-theft protection	94
Mercedes me App	25	Information on the automatic functions of the restraint system	48	Seats and stowing	98
Service and vehicle operation	26	Purpose and function of the restraint system	52	Notes on the correct driver's seat position	98
Operating safety	27	Seat belts	57	Notes on grab handles	98
				Seats	99

Steering wheel	108
Easy entry and exit feature	110
Memory function	112
Stowage areas	113
Cup holder	126
Ashtray and cigarette lighter	127
Sockets	128
Wireless charging of the mobile phone and connection with the exterior antenna	129
Installing/removing the floor mats	131

Light and visibility	133
Exterior lighting	133
Interior lighting	138
Windshield wiper and windshield washer system	139
Mirrors	143
Area permeable to radio waves on the windshield	146
Infrared-reflective windshield function	146

Climate control	147
Overview of climate control systems	147
Operating the climate control system	148

Driving and parking	155
Driving	155
DYNAMIC SELECT	170
Automatic transmission	174
Function of 4MATIC	179
Refueling	179
Parking	182
Driving and driving safety systems	190
Trailer hitch	266
Vehicle towing instructions	271

Driver's display	272
Notes on the driver display	272
Driver display malfunction	272
Operating the driver display	273
Driver display menus	274
Head-up Display	275
Vehicles with a 48 V on-board electrical system	277
Overview of status indicators on the driver display	277

MBUX multimedia system	279
Overview and operation	279

System settings	290
Off-road menu	295
Navigation and traffic	298
Telephone	309
Mercedes me Apps	312
Mercedes-Benz emergency call system	319
Radio & media	323
Sound settings	329

Maintenance and care	330
ASSYST PLUS service interval display	330
Maintenance Management	331
Telediagnosis	331
Engine compartment	332
Cleaning and care	338

Breakdown assistance	348
Emergency	348
Flat tire	350
Battery (vehicle)	354
Tow starting or towing away	361
Electrical fuses	366

Wheels and tires	370
Notes on noise or unusual handling characteristics	370
Notes on regularly inspecting wheels and tires	370
Notes on snow chains	371
Tire pressure	371
Loading the vehicle	377
Tire labeling	381
Definition of terms for tires and loading	387
Changing a wheel	389
Emergency spare wheel	398
Collapsible spare wheel	400

Technical data	403
Notes on technical data	403
Vehicle electronics	403
Radio regulations	405
Vehicle identification plate, VIN and engine number overview	405
Operating fluids	407
Vehicle data	414
Trailer hitch	417

Display messages and warning/indicator lamps	419
Display messages	419
Warning and indicator lamps	476

Index	495
--------------------	------------

In this Operator's Manual, you will find the following symbols:

 **WARNING** Danger due to failure to observe the warning notices

Warning notices draw your attention to hazards that may endanger your health or life, or the health or life of others.

 Observe the warning notices.

 **ENVIRONMENTAL NOTE** Environmental damage due to failure to observe environmental notes

Environmental notes include information on environmentally responsible behavior or environmentally responsible disposal.

 Observe environmental notes.

 **NOTE** Damage to property due to failure to observe notes on material damage

Notes on material damage inform you of risks which may lead to your vehicle being damaged.

 Observe notes on material damage.

 These symbols indicate useful instructions or further information that could be helpful to you.

 Instruction

(→ page) Further information on a topic

Display Display in the central display







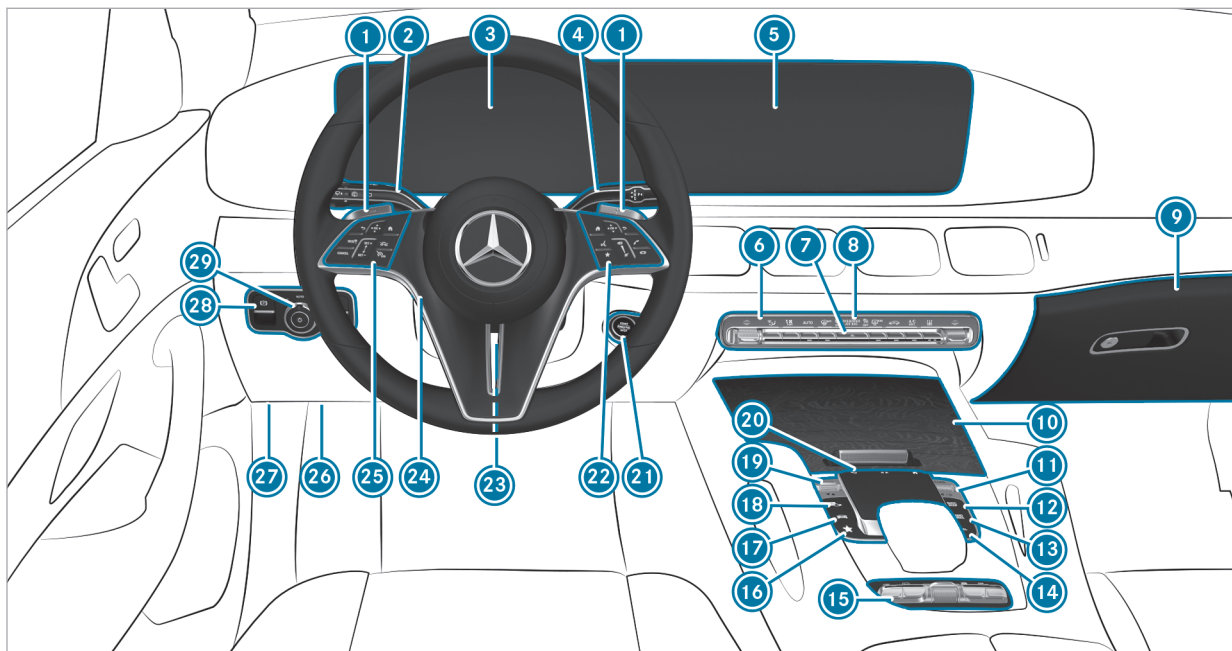







 Highest menu level, which is to be selected in the multimedia system

 Relevant submenus, which are to be selected in the multimedia system









* Indicates a cause



Left-hand drive vehicles

①	Steering wheel paddle shifters	→	177	⑮	Switch panel for:		
②	Combination switch	→	134		Off-road menu	→	295
③	Driver display	→	272	M	Manual gearshifting	→	177
④	DIRECT SELECT lever	→	174		AIRMATIC or	→	233
⑤	Central display	→	280		E-ACTIVE BODY CONTROL	→	237
⑥	Climate control systems	→	148		Activates/deactivates ESP®	→	194
⑦	 Hazard warning light system	→	135		Downhill Speed Regulation	→	209
⑧	PASSENGER AIR BAG indicator lamps	→	46	⑯	 Calls up favorites	→	281
⑨	Glove box	→	117	⑰	 Calls up vehicle functions	→	281
⑩	Storage compartment	→	117	⑱	 Active Parking Assist	→	257
⑪	 Controller for volume and switching sound on/off	→	280	⑲	DYNAMIC SELECT switch	→	172
	 Switches the MBUX multimedia system on/off	→	280	⑳	Touchpad	→	281
⑫	 Calls up navigation	→	281	㉑	Start/stop button	→	156
⑬	 Calls up radio or media	→	281		ECO start/stop function	→	167
⑭	 Calls up the telephone	→	281	㉒	Control panel for the MBUX multimedia system	→	281
				㉓	Adjusts the steering wheel manually	→	108

8 At a glance - Cockpit

 24	Adjusts the steering wheel electrically	→	109		Active Distance Assist DISTRONIC	→	204
	Switches the steering wheel heater on/off	→	110	 26	Diagnostics connection	→	31
 25	Control panel:			 27	Opens the hood	→	332
	Driver display	→	273	 28	Electric parking brake	→	186
	Cruise control	→	200	 29	Light switch	→	133



10 At a glance - Indicator and warning lamps

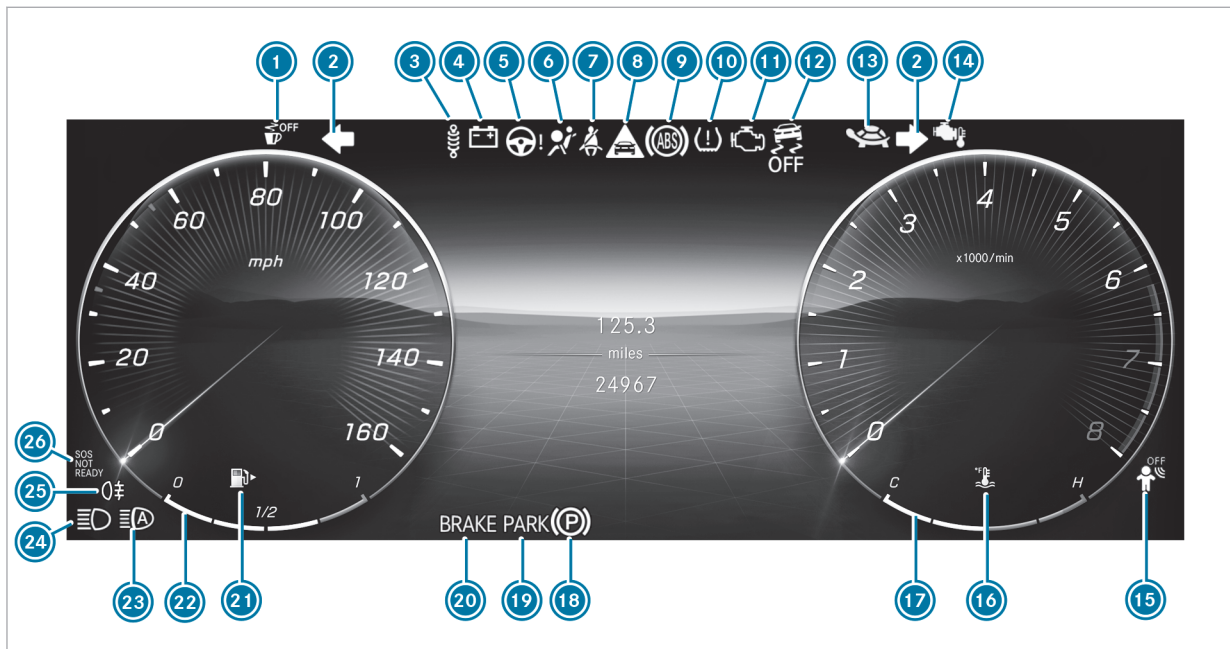

Driver display

1		ATTENTION ASSIST	→	488
2		Turn signal lights	→	134
3		Suspension (red)	→	488
		Suspension (yellow)	→	488
4		Electrical malfunction	→	481
5		Power steering (red)	→	480
		Power steering (yellow)	→	480
6		Restraint system	→	478
7		Seat belt	→	478
8		Distance warning	→	488
9		ABS	→	488
10		Tire pressure monitor	→	493
11		Engine diagnostics	→	481
12		ESP® OFF	→	488
		ESP®	→	488
13		Drive system: reduced power	→	480

14		Gasoline engine: engine operating temperature	→	481
15		Occupant presence reminder (white)	→	478
		Occupant presence reminder (yellow)		
16		Coolant temperature	→	481
17		Coolant temperature display		
18		Electric parking brake (yellow)	→	485
19		Electric parking brake (red)	→	485
		USA only		
		Canada only		
20		Brakes (red)	→	485
		USA only		
		Canada only		
		Recuperative Brake System, USA only	→	485
		Brakes (yellow), Canada only	→	485
21		Reserve fuel with fuel filler flap location indicator		

12 At a glance - Indicator and warning lamps

22 Fuel level

23  Adaptive Highbeam Assist → 137

24  High beam → 134

 Low beam → 133

 Side lights → 133







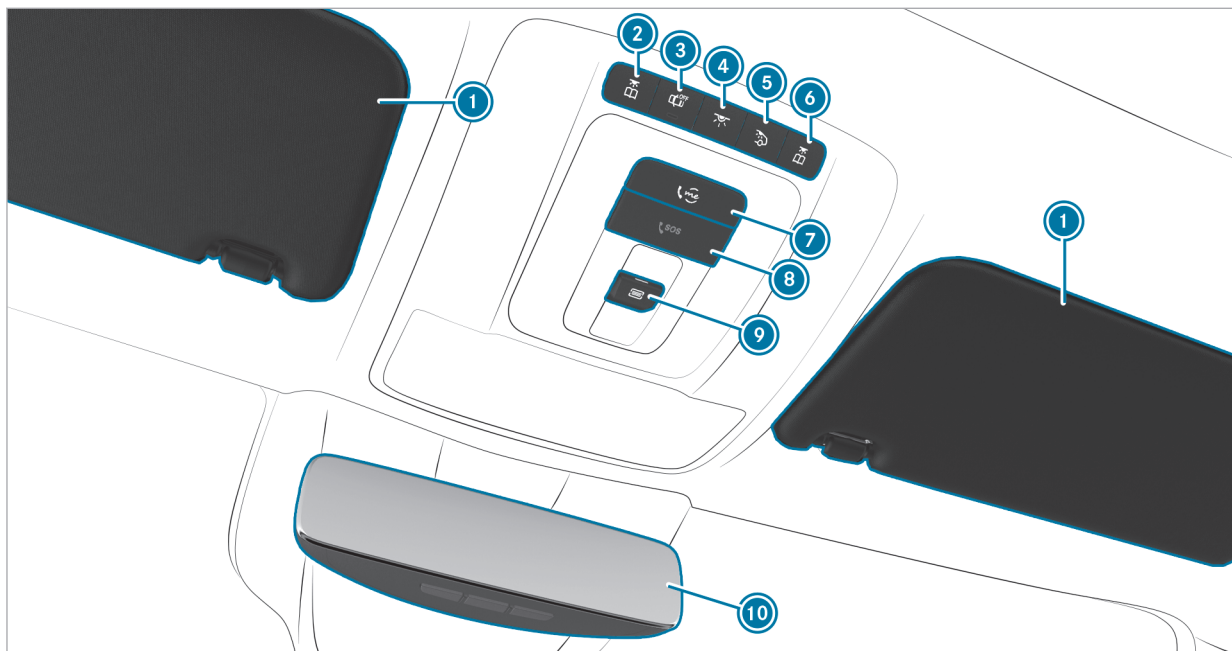

25  Rear fog light → 134

26  Mercedes-Benz emergency call system → 493











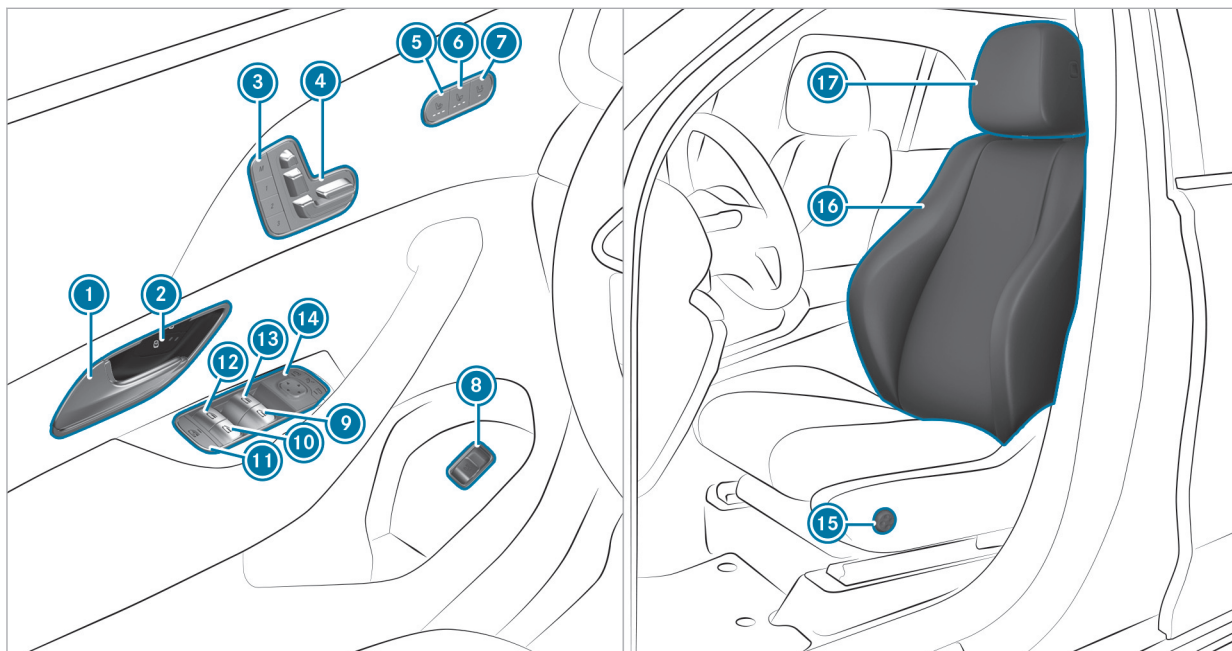





14 At a glance - Overhead control panel



①	Sun visors		
②	 Switches the left-hand reading lamp on/off	→	138
③	 Switches automatic interior lighting control on/off	→	138
④	 Switches the front interior lighting on/off	→	138
⑤	 Switches the rear interior lighting on/off	→	138
⑥	 Switches the right-hand reading lamp on/off	→	138
⑦	 me button	→	312
⑧	 SOS button	→	312
⑨	 Opens/closes the panorama roof with power tilt/sliding panel	→	90
	 Opens/closes the roller sunblind	→	90
⑩	Inside rear-view mirror	→	144

16 At a glance - Door operating unit and seat adjustment



1	Opens the door	→	77	10	 Opens/closes the rear right side window	→	87
2	  Locks/unlocks the vehicle	→	77	11	 Child safety lock for the rear side windows	→	72
3	 Sets the memory function	→	113	12	 Opens/closes the rear left side window	→	87
4	Adjusts the seats electrically	→	99	13	 Opens/closes the left side window	→	87
5	 Switches the seat heating on/off	→	106	14	 Operates the outside mirrors	→	143
6	 Switches the seat ventilation on/off	→	108	15	Adjusts the 4-way lumbar support	→	102
7	 Adjusts the front passenger seat from the driver's seat	→	101	16	Seat adjustment using the multimedia system	→	104
8	 Opens/closes the tailgate	→	81	17	Adjusts the head restraints	→	102
9	 Opens/closes the right side window	→	87				

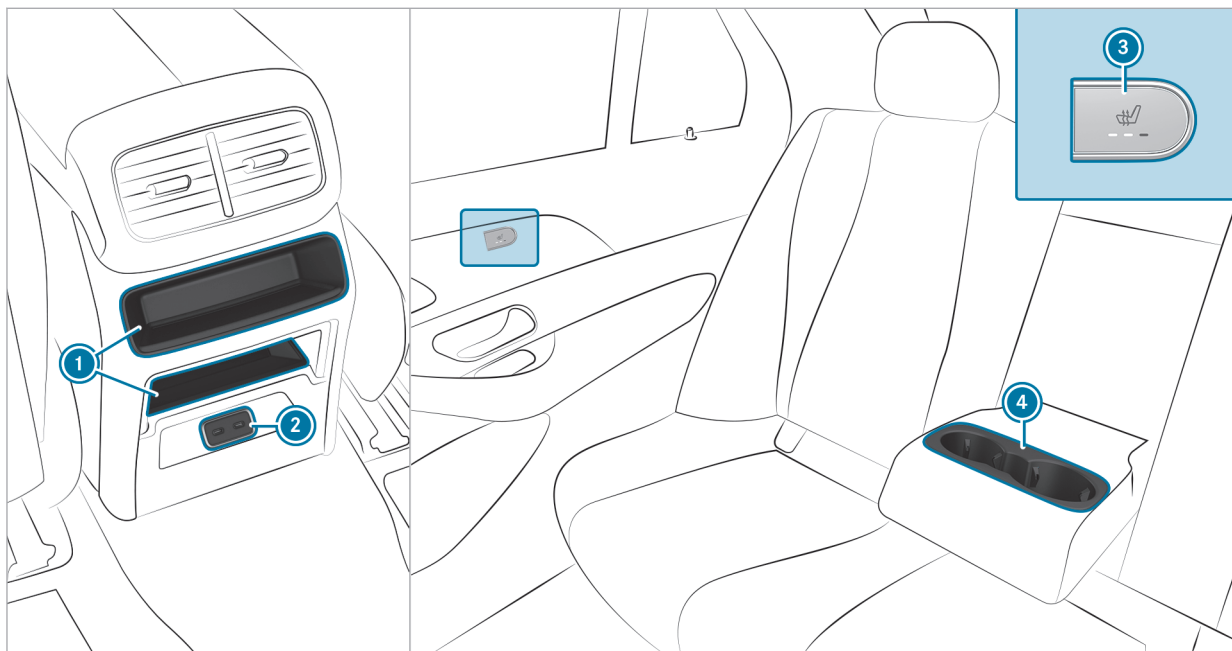

18 At a glance - Control settings in the rear passenger compartment

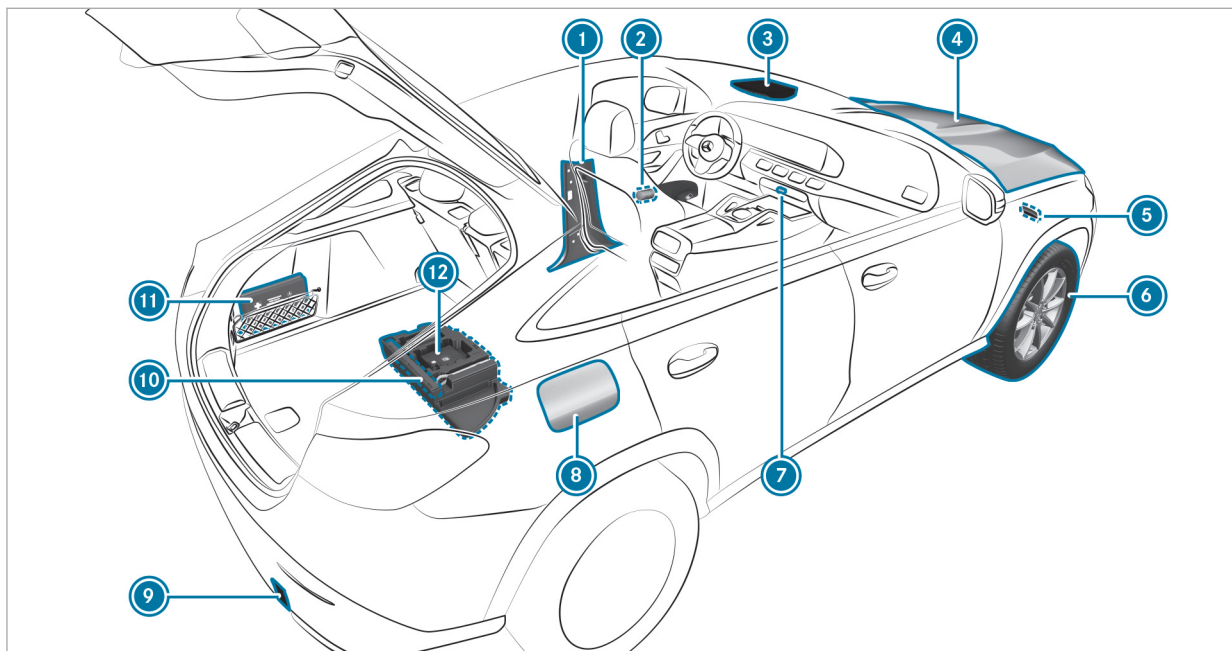

- ① Storage compartments in the center console
- ② USB charge port → 129

- ③  Switches the rear seat heating on/off → 106
- ④ Cup holder



1	B-pillar with:		
	QR code for accessing the rescue card	→	35
2	Safety vests	→	348
3	 me button	→	312
	 SOS button	→	312
4	To check and refill operating fluids	→	407
	Jump-starting	→	359
5	Tow-starting or towing away	→	362
6	Flat tire	→	350

7	 Hazard warning light system	→	135
8	Fuel filler flap with:		
	information label on fuel type	→	179
	Information label on tire pressure	→	373
	QR code for accessing the rescue card	→	35
9	Tow-starting or towing away	→	362
10	Warning triangle	→	349
11	First-aid kit (soft sided)	→	349
12	TIREFIT kit	→	351

Calling up the Digital Operator's Manual

Multimedia system:

→  » Settings » Info

» Operator's Manual

» Open Digital Operator's Manual

The Digital Operator's Manual describes the functions and operation of the vehicle and the multimedia system.

▶ Select one of the following menu items in the Digital Operator's Manual:

- **Quick start:** find the first steps towards adjusting your seat (driver's side).
- **Tips:** find information that prepares you for certain everyday situations with your vehicle.
- **Animations:** watch animations of the vehicle functions.
- **Messages:** receive additional information about the messages on the driver display.
- **Language:** select the language for the Digital Operator's Manual.

You can search for keywords using the search field **Search** in order to find quick answers to questions regarding operation of the vehicle.

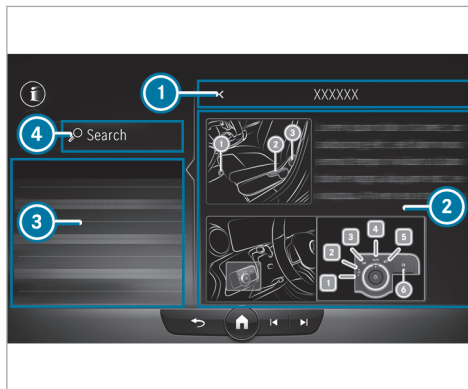

- ① Back
- ② Contents section
- ③ Menu
- ④ Search

Some sections in the Digital Operator's Manual, such as warning notes, can be expanded and collapsed.

Additional options for calling up the Digital Operator's Manual:

Driver display: call up brief information regarding display messages on the driver display. Pressing  will show brief information on the central display.

MBUX Voice Assistant: call-up via the voice control system

Global search: call up search results for contents of the Digital Operator's Manual in the home screen

 For safety reasons, the Digital Operator's Manual is deactivated while driving.

Environmental protection

 **ENVIRONMENTAL NOTE** Environmental damage due to operating conditions and personal driving style

The pollutant emission of the vehicle is directly related to the way you operate the vehicle.

Operate your vehicle in an environmentally responsible manner to help protect the environment. Please observe the following recommendations on operating conditions and personal driving style.

Operating conditions:

- ▶ Make sure that the tire pressure is correct.
- ▶ Do not carry any unnecessary weight (e.g. roof luggage racks once you no longer need them).
- ▶ Adhere to the service intervals. A regularly serviced vehicle will contribute to environmental protection.

- ▶ Always have maintenance work carried out at a qualified specialist workshop.

Personal driving style:

- ▶ Do not depress the accelerator pedal when starting the engine.
- ▶ Do not warm up the vehicle while stationary.
- ▶ Drive carefully and maintain a suitable distance from the vehicle in front.
- ▶ Avoid frequent, sudden acceleration and braking.
- ▶ Change gear in good time and use each gear only up to $\frac{2}{3}$ of its maximum engine speed.
- ▶ Switch off the vehicle in stationary traffic, e.g. by using the ECO start/stop function.
- ▶ Drive in a fuel-efficient manner. Observe the ECO display for an economical driving style.

Environmental issues and recommendations:

It is recommended that you re-use or recycle materials instead of just disposing of them.

The relevant environmental guidelines and regulations serve to protect the environment and must be strictly observed.

Mercedes-Benz GenuineParts

 **ENVIRONMENTAL NOTE** Environmental damage due to not using recycled reconditioned components

Mercedes-Benz AG offers recycled reconditioned components and parts with the same quality as new parts. The same entitlement from the Limited Warranty is valid as for new parts.

- ▶ Use recycled reconditioned components and parts from Mercedes-Benz AG.

! **NOTE** Impairment of the operating efficiency of the restraint systems from installing accessory parts or from repairs or welding

Air bags and Emergency Tensioning Devices, as well as control units and sensors for the restraint systems, may be installed in the following areas of your vehicle:

- doors
- door pillars
- sill
- seats
- cockpit
- instrument display
- center console
- lateral roof frame

- ▶ Do not install accessory parts such as audio systems in these areas.
- ▶ Do not carry out repairs or welding.

▶ Have accessories retrofitted at a qualified specialist workshop.

You could jeopardize the operating safety of your vehicle if you use parts, tires and wheels, as well as accessories relevant to safety that have not been approved by Mercedes-Benz. Safety-critical systems (e.g. the brake system) may malfunction. Use only Mercedes-Benz GenuineParts or parts of equal quality. Use only tires, wheels and accessory parts that have been specifically approved for your vehicle model.

Mercedes-Benz GenuineParts are subject to strict quality inspections. Each part has been specially developed, manufactured or selected for Mercedes-Benz vehicles and adapted to them. Therefore, only Mercedes-Benz GenuineParts should be used.

More than 300,000 different Mercedes-Benz GenuineParts are available for Mercedes-Benz models.

All Mercedes-Benz Service Centers maintain a supply of Mercedes-Benz GenuineParts for necessary service and repair work. In addition, strategi-

cally located parts delivery centers ensure quick and reliable parts service.

Always specify the vehicle identification number (VIN) (→ page 405) when ordering Mercedes-Benz GenuineParts.

Operator's Manual

This Operator's Manual and the Digital Operator's Manual in the vehicle describe the following models and the standard and special equipment for your vehicle:

- The models and the standard and special equipment available at the time of this Operator's Manual going to press.
- The models and the standard and special equipment available only in certain countries.
- The models and the standard and special equipment that will become available only at a later date.

Please note that your vehicle may not be equipped with all features described. This also applies to systems relevant to safety. The equipment on

your vehicle may therefore differ from that in the descriptions and illustrations.

The original purchase agreement for your vehicle includes a list of the equipment in your vehicle at the time of delivery.

Should you have any questions concerning equipment and operation, please consult an authorized Mercedes-Benz Center.

i Please bear in mind that all the speed figures stated in this Operator's Manual are approximate and are subject to a certain tolerance.

The Operator's Manual, Supplement, further supplementary documents and Maintenance Booklet (USA only) are important documents and should be kept in the vehicle.

Touch-sensitive controls

In addition to conventional switches and buttons, your vehicle is equipped with touch-sensitive controls.

These are located in the following areas of your vehicle:

- Roof and door control panel
- Climate control
- Steering wheel
- MBUX multimedia system

The controls have touch-sensitive user interface surfaces. You can control these surfaces by pressing or swiping to adjust settings or to trigger functions, for example.

The touch-sensitive interface on the touchscreen also provides haptic feedback in the form of pulses, vibrations or changes in the surface structure, for example.

You will receive haptic feedback in the following situations, for example:

- When pressing a button on the user interface
- When scrolling in a list or table
- When you reach a new area on the user interface, e.g. a pop-up window

When using touch-sensitive user interfaces, note the following points to avoid problems:

- Do not affix stickers or similar objects to the surfaces.
- Do not attach smartphone holders or other mountings to the surface of the central display.
- Keep the surfaces protected from moisture and wet conditions.
- Keep the surfaces free of dust and dirt (→ page 345).

Some touch-sensitive controls have both a symbol and integrated indicator lamps. Be sure to press on the symbol of the control element when using it.

Mercedes me App

Notes about the on-demand feature

You can also activate various functions (on-demand feature) subsequently via Mercedes me after purchasing your vehicle.

Information is available at any authorized Mercedes-Benz Center.

Activating on-demand feature using Mercedes me

Requirements

- The vehicle has a wireless connection.
- The vehicle is linked to the Mercedes me user account.

Ordering and activating on-demand feature

- ▶ Add the desired on-demand feature for the vehicle to the shopping basket in the Mercedes me Store.
- ▶ Complete the order.
The on-demand feature is activated when operating the vehicle.

Speeding up activation

- ▶ Switch the vehicle off and lock it.

- ▶ Unlock the vehicle after about two minutes and switch on the vehicle.
The on-demand feature has been activated.
For some features, a notification also appears in the vehicle's multimedia system.

If the activation was not successful, repeat the process.

Service and vehicle operation

Vehicle operation outside the USA or Canada

When you are abroad with your vehicle, observe the following points:

- service points or replacement parts may not be available immediately.
- unleaded fuel may not be available for vehicles with a catalytic converter. Leaded fuel may cause damage to the catalytic converter.
- the fuel may have an extremely low octane number. Unsuitable fuel can cause engine damage.

Some Mercedes-Benz models are available in Europe through our European Delivery Program.

For more information, please consult a Mercedes-Benz service outlet, or write to one of the following addresses:

in the USA:

Mercedes-Benz USA, LLC
One Mercedes-Benz Drive
Sandy Springs, GA 30328

in Canada:

Mercedes-Benz Canada, Inc.
2680 Matheson Blvd E, Suite 500
Mississauga, ON L4W 0A5

Maintenance

USA only:

Your customer advisor confirms the service in the service report.

Roadside Assistance

The Mercedes-Benz Roadside Assistance Program offers technical help in the case of a breakdown. Your calls to the toll-free Roadside Assistance

Hotline are answered by our agents 24 hours a day, 365 days a year.

1-800-FOR-MERCEdes (1-800-367-6372) (USA)

1-800-387-0100 (Canada)

USA only: You can find further information in the Mercedes-Benz Roadside Assistance Program brochure.

Canada only: You can find further information in the "Roadside Assistance" section in the Warranty Information Guide. Please refer to Mercedes-Benz Canada's website:

<https://www.mercedes-benz.ca/en/owners/manuals> (English)

<https://www.mercedes-benz.ca/fr/owners/manuals> (French)

Change of address or change of ownership

In the event of a change of address, please send us the "Notification of address change" in the Service and Guarantee booklet or simply call the Mercedes-Benz Customer Assistance Center (USA) on the hotline number 1-800-FOR-MERCEdes (1-800-367-6372) or Customer Service (Canada) on 1-800-387-0100. We can then reach you in a timely fashion, if necessary.

If you sell your Mercedes, please leave all literature in the vehicle so that it is available to the next owner. If you have purchased a used vehicle, please send us the "Notice of Purchase of Used Car" in the Service and Guarantee booklet or simply call the Mercedes-Benz Customer Assistance Center (USA) at the hotline number 1-800-FOR-MERCEdes (1-800-367-6372) or Customer Service (Canada) at 1-800-387-0100.

Possible danger due to substances hazardous to health

In compliance with Proposition 65 ("Prop65"), the following detachable label has been added to each vehicle sold in California:



WARNING



Operating, servicing and maintaining a passenger vehicle, pickup truck, van or off-road motor vehicle can expose you to chemicals including engine exhaust, carbon monoxide, phthalates, and lead, which are known to the State of California to cause cancer and birth defects or other reproductive harm. To minimize exposure, avoid breathing exhaust, do not idle the engine except as necessary, service your vehicle in a well-ventilated area and wear gloves or wash your hands frequently when servicing your vehicle. For more information go to www.P65Warnings.ca.gov/passenger-vehicle

A 000 817 82 02

Operating safety



WARNING Risk of accident due to malfunctions or system failures

If you do not have the prescribed service/maintenance work or any required repairs carried out, this could result in malfunctions or system failures.

- ▶ Always have the prescribed service and maintenance work or any required repairs carried out in a qualified specialist workshop.

⚠ WARNING Risk of accident or injury due to incorrect modifications on electronic component parts

Modification of electronic components, their software or wiring could impair their function and/or the function of other networked component parts or safety-relevant systems.

This can endanger the operating safety of the vehicle.

- ▶ Never tamper with the wiring and electronic component parts or their software.
- ▶ You should have all work on electrical and electronic components carried out at a qualified specialist workshop.

Observe the "On-board electronics" section in the "Technical data".

⚠ WARNING Risk of fire caused by flammable material on hot exhaust system components

Flammable material such as leaves, grass or twigs may ignite if they come into contact with hot parts of the exhaust system.

- ▶ When driving on an unpaved road or off-road, check the vehicle underside regularly.
- ▶ In particular, remove trapped plant parts or other flammable material.
- ▶ If there is damage, consult a qualified specialist workshop immediately.

! NOTE Damage to the vehicle due to driving too fast and due to impacts to the vehicle underbody or suspension components

In the following situations, in particular, there is a risk of damage to the vehicle:

- The vehicle becomes grounded, e.g. on a high curb or an unpaved road
- The vehicle is driven too fast over an obstacle, e.g. a curb, speed bump or pothole
- A heavy object strikes the underbody or suspension components

In situations such as these, damage to the body, underbody, suspension components, wheels or tires may not be visible. Components damaged in this way can unexpectedly fail or, in the case of an accident, may no longer absorb the resulting force as intended.

If the underbody paneling is damaged, flammable materials such as leaves, grass or twigs can collect between the underbody and the

underbody paneling. These materials may ignite if they come into contact with hot parts of the exhaust system.

- ▶ Have the vehicle checked and repaired immediately at a qualified specialist workshop.

or

- ▶ If driving safety is impaired while continuing your journey, pull over and stop the vehicle immediately, while paying attention to road and traffic conditions, and contact a qualified specialist workshop.

Vehicles with a 48V on-board electrical system

⚠ DANGER Risk of fatal injury by touching damaged high-voltage components

Vehicles with a 48 V on-board electrical system contain individual high-voltage components. These high-voltage components are under high voltage.

If you modify component parts of these high-voltage components or touch damaged component parts, you may be electrocuted.

High voltage components may be damaged in an accident, although the damage may not be visible.

- ▶ Never perform modifications to component parts of high-voltage components.
- ▶ Never touch damaged component parts of high-voltage components.
- ▶ Never touch component parts of high-voltage components after an accident.

Vehicles with a 48V on-board electrical system contain high voltage components. These components are marked with a high-voltage label:

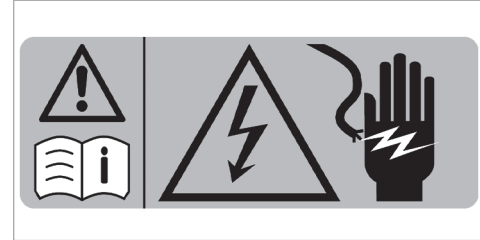

Example

All work on high voltage components must be carried out at a qualified specialist workshop.

Installing the license plate on the front license plate bracket

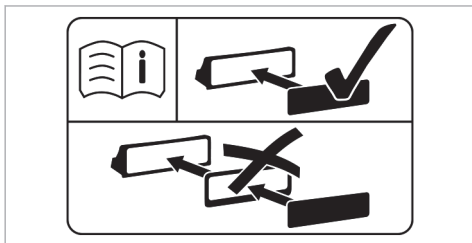

The information label can be found on the license plate bracket, either embossed or in sticker form.

! **NOTE** Malfunctions and system failures due to incorrect mounting of the license plate on the front license plate holder

If the license plate is incorrectly mounted on the front license plate holder, sensors, cameras or driving and safety systems may malfunction or fail.

Observe the following points when mounting the license plate on the front license plate holder:

- ▶ Mount the license plate directly on the license plate holder without advertising media or other holders.
- ▶ Mount the license plate so that it does not protrude above or to the side of the license plate adapter.

National information for components relevant to radio regulation

Information on crossing national borders

You must observe the radio regulations for the country in which you are currently operating your vehicle.



USA: "Radio based devices of this vehicle comply with Part 15 of the FCC Rules. Operation is subject to the following two conditions: 1) These devi-

ces may not cause harmful interference, and 2) These devices must accept any interference received, including interference that may cause undesired operation. Changes or modifications not expressly approved by the party responsible for compliance could void the user's authority to operate the equipment."

Canada: "This vehicle contains licence-exempt transmitter(s)/receiver(s) that comply with Innovation, Science and Economic Development Canada's licence-exempt RSS(s). Operation is subject to the following two conditions: (1) These devices may not cause interference. (2) These devices must accept any interference, including interference that may cause undesired operation of the devices." "Les émetteurs/récepteurs dans cette véhicule sont conforme aux CNR d'Innovation, Sciences et Développement économique Canada applicables aux appareils radio exempts de licence. L'exploitation est autorisée aux deux conditions suivantes : 1) Ces appareils ne doivent pas produire de brouillage; 2) Ces appareils doivent accepter tout brouillage radioélectrique subi, même si le brouillage est susceptible d'en compromettre le fonctionnement."

Diagnostics connection

The diagnostics connection is a technical interface in the vehicle. It is used, for example, in the context of repair and maintenance work or for reading out vehicle data in a specialist workshop. Diagnostic devices should therefore only be connected in a qualified specialist workshop.

⚠ WARNING Risk of accident due to connecting devices to the diagnostics connection

If you connect devices to the diagnostics connection of the vehicle, the function of vehicle systems and operating safety may be impaired.

- ▶ For safety reasons, we recommend that you use and connect only products approved by an authorized Mercedes-Benz Service Center.

⚠ WARNING Risk of accident due to objects in the driver's footwell

Objects in the driver's footwell may impede pedal travel or block a depressed pedal.

This will jeopardize the operating- and road safety of the vehicle.

- ▶ Stow all objects in the vehicle securely so that they cannot get into the driver's footwell.
- ▶ Make sure that there is always sufficient clearance for the pedals.
- ▶ Always install the floor mats securely and as prescribed.
- ▶ Do not use loose floor mats and do not place floor mats on top of one another.

⚠ NOTE Battery discharging from using devices connected to the diagnostics connection

Using devices at the diagnostics connection drains the battery.

- ▶ Check the charge level of the battery.
- ▶ If the charge level is low, charge the battery, e.g. by driving a considerable distance.

Please also observe the notes on the 12 V battery and on short-distance trips in the chapter "Driving and Parking" (→ page 160).

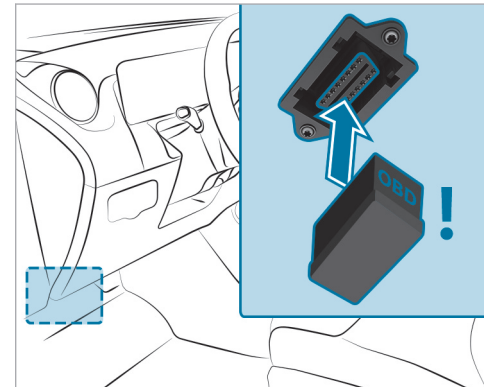

Connecting and using another device with the diagnostics connection can have the following effects:

- Malfunctions in the vehicle system
- Permanent damage to vehicle components

Please refer to the warranty terms and conditions for this matter.

Moreover, connecting equipment to the diagnostics connection can lead to emissions monitoring information being reset, for example. This may lead to the vehicle failing to meet the requirements of the next emissions inspection during the main inspection.

Qualified specialist workshop

A Mercedes-Benz service center is a qualified specialist workshop. It has the necessary special skills, tools and qualifications to correctly carry out the work required on your vehicle. This particularly applies to safety-critical work.

For the following, always have your vehicle checked at a Mercedes-Benz service center:

- Safety-critical work
- Service- and maintenance work
- Repair work
- Modifications as well as installations- and conversions
- Work on electronic components
- **Vehicles with 48 V on-board electrical system:** work on high-voltage components of the 48 V on-board electrical system

Mercedes-Benz recommends a Mercedes-Benz service center.

Correct use of the vehicle

If you remove any warning stickers, you or others could fail to recognize certain dangers. Leave warning stickers in position.

Observe the following information in particular when driving your vehicle:

- the safety notes in this Operator's Manual, vehicle-specific supplements and further supplementary documents
- technical data for the vehicle
- traffic laws and regulations of the country you are currently driving in
- laws pertaining to motor vehicles and safety standards of the country you are currently driving in
- radio regulatory requirements of the country you are currently driving in

Sport Utility Vehicle

⚠ WARNING Risk of accident when the center of gravity is too high

The vehicle may start to skid and rollover in the event of sudden steering maneuvers and/or when the vehicle's speed is not adapted to the road conditions.

▶ Always adapt your speed and driving style to the vehicle's driving characteristics and to the prevailing road and weather conditions.

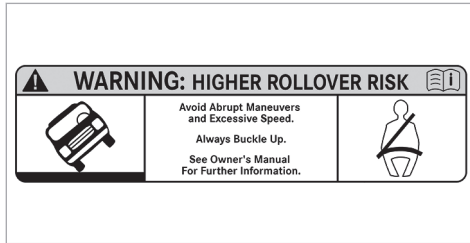

USA

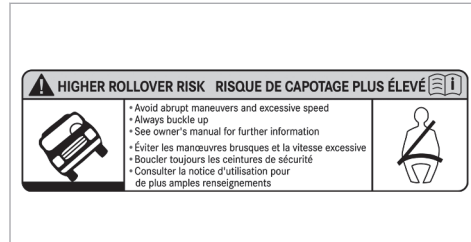

Canada

Utility vehicles have a significantly higher rollover rate than other types of vehicles.

If this type of vehicle is not driven safely, an accident can occur, the vehicle can roll over and occupants can suffer serious or even fatal injuries.

In a rollover crash, an unbelted person is significantly more likely to die than a person wearing a seat belt.

You and all vehicle occupants should always wear your seat belts.

Notes for persons with electronic medical aids

Despite meticulous development of their vehicle systems, Mercedes-Benz AG cannot completely rule out the interaction of vehicle systems with electronic medical aids, such as cardiac pacemakers.

In addition, there are components installed in the vehicle that can generate magnetic fields on a par with permanent magnets, regardless of the operating status of the vehicle. These fields may occur in the area around the multimedia system and sound system, for example, or in the area around the seats, depending on the respective vehicle equipment.

In some cases, this could result in the following, depending on the aids used:

- Medical aids malfunctioning
- Adverse health effects

Observe the notes and warnings of the manufacturer of the medical aids; if in doubt, contact the device manufacturer and/or your doctor. If there is continuing uncertainty concerning the possibility of medical aids malfunctioning,

Mercedes-Benz AG recommends using fewer electrical vehicle systems and/or maintaining a distance from the components.

Always have repairs and maintenance work in the area of the following components carried out at a qualified specialist workshop:

- vehicle components carrying live voltage
- transmission antenna
- multimedia system and sound system

If you have any queries or suggestions, consult a qualified specialist workshop.

Problems with your vehicle

If you should experience any problem with your vehicle, particularly one that you believe may affect its safe operation, we urge you to contact a Mercedes-Benz Service Center immediately to have the problem diagnosed and rectified. If the problem is not resolved to your satisfaction there, please contact a Mercedes-Benz Service Center again or write to one of the following addresses.

In the USA:

Mercedes-Benz USA, LLC
Customer Assistance Center
One Mercedes-Benz Drive
Sandy Springs, GA 30328

In Canada:

Mercedes-Benz Canada, Inc.
Customer Assistance Center
2680 Matheson Blvd E, Suite 500
Mississauga, ON L4W 0A5

Reporting safety defects

USA only:

The following text is published as required of manufacturers under Title 49, Code of U.S. Federal Regulations, Part 575 pursuant to the “National Traffic and Motor Vehicle Safety Act of 1966”.

If you believe that your vehicle has a defect which could cause a crash or could cause injury or death, you should immediately inform the National Highway Traffic Safety Administration (NHTSA) in addition to notifying Mercedes-Benz USA, LLC.

If NHTSA receives similar complaints, it may open an investigation, and if it finds that a safety defect exists in a group of vehicles, it may order a recall and remedy campaign. However, NHTSA cannot become involved in individual problems between you, your dealer, or Mercedes-Benz USA, LLC.

To contact NHTSA, you may call the Vehicle Safety Hotline toll-free at 1-888-327-4236 (TTY: 1-800-424-9153) ; go to <https://www.safercar.gov>; or write to: Administrator, NHTSA, 400 Seventh Street, SW., Washington, DC 20590, USA.

You can also obtain other information about motor vehicle safety from <https://www.safercar.gov>.

Canada only:

The following text is published as required of manufacturers under subsection 18.4 (4) of the Motor Vehicle Safety Regulations.

If you believe that your vehicle has a defect which could cause a crash or could cause injury or death, you should immediately inform Transport Canada in addition to notifying Mercedes-Benz Canada Inc.

If Transport Canada received similar complaints, it may open an investigation, and if it finds that a safety defect exists in a group of vehicles, it may order a recall and remedy campaign. However, Transport Canada cannot become involved in individual problems between you, your dealer, or Mercedes-Benz Canada Inc.

To contact Transport Canada, you may call the Defect Investigations and Recalls Division toll-free in Canada at 1-800-333-0510 or 819-994-3328 in the Gatineau-Ottawa area or internationally; may also go to the following websites for more information:

- English: <https://www.tc.gc.ca/recalls>
- French: <https://www.tc.gc.ca/rappels>

Limited Warranty

! **NOTE** Damage to the vehicle arising from violation of these operating instructions.

Damage to the vehicle can arise from violation of these operating instructions.

This damage is not covered either by the Mercedes-Benz implied warranty or by the New- or Used-Vehicle Warranty.

- ▶ Follow the instructions in these operating instructions on proper operation of your vehicle as well as on possible vehicle damage.

QR code for rescue card

QR codes are attached to the inside of the fuel filler flap and on the opposite side on the B-pillar. In the event of an accident, rescue services can use the QR code to quickly find the appropriate rescue card for your vehicle. The current rescue card contains the most important information about your vehicle (e.g. the routing of the electric lines) in compact form.

You can find further information at: <https://rk.mb-qr.com/de/>

Data storage

Data processing in the vehicle

Electronic control units

There are electronic control units installed in your vehicle. Control units process data that they e.g. receive from vehicle sensors, generate themselves or exchange among themselves. Some control units are required for the safe operation of your vehicle. For example, some assist you when you are driving, such as driver assistance systems, while others enable convenience or infotainment functions.

The following provides you with general information regarding data processing in the vehicle. Additional information on what specific data is collected, stored and transmitted to third parties for what purpose in your vehicle can be found in the notes on the functional features in question in the respective operating instructions. These are also available online and, depending on the equipment, digitally in the vehicle.

Personal data

Each vehicle is marked with a unique vehicle identification number. Depending on the country, this vehicle identification number can be used by, for example, government authorities to determine the identity of the owner. There are other possibilities for using data collected from the vehicle to identify the owner or driver, such as the license plate number.

The data generated or processed by control units may therefore be personal or, in certain circumstances, become personal. Depending on which vehicle data are available, it may be possible to make inferences about, for example, your driving behavior, your location, your route or your use patterns.

Legal requirements for the disclosure of data

If legal regulations exist, manufacturers are generally obligated to release data stored by the manufacturer to the necessary extent in individual cases at the request of state authorities. This may be the case during the investigation of a criminal offense, for example.

Within the framework of applicable law, state authorities are also authorized to take data readouts from vehicles themselves in specific cases. In the event of an accident, for example, information readouts can be taken from the air bag control unit to help to establish what happened.

Operating data in the vehicle

Control units process data to operate the vehicle.

This includes the following data, for example:

- Vehicle status information such as speed, longitudinal acceleration, lateral acceleration, number of wheel revolutions or the fastened seat belts indicator
- Ambient conditions, such as temperature, rain sensor or distance sensor

As a rule, this data is volatile, is not stored beyond the operating time and is processed only in the vehicle itself. Control units (e.g. the vehicle key) often contain data memories. These are used to temporarily or permanently document information about the vehicle's operating state, component stress, maintenance requirements or technical events and malfunctions.

Depending on the technical equipment, the following data will be stored:

- Operating status of system components (e.g. fill levels, tire pressure, battery status)
- Malfunctions or faults in important system components (e.g. lights, brakes)
- System reactions in special driving situations (e.g. air bag deployment, the intervention of stability control systems)
- Information on events leading to vehicle damage

In special cases, it may be necessary to store data that would otherwise only be volatile. This may be the case if the vehicle has detected a malfunction, for example.

If you use services such as repair services or maintenance work, stored operational data readouts can be taken and used together with the vehicle identification number, where necessary. Readouts can be taken by service network employees such as workshops and manufacturers, or third parties, such as breakdown services.

The same is true in the case of warranty claims and quality assurance measures.

The readout will usually be taken via the diagnostics connection in the vehicle, which is required by law. The operating data readout taken documents technical conditions of the vehicle or individual components and helps to diagnose malfunctions, meet warranty obligations and improve quality. This data, particularly information on component stress, technical events, operating errors and other malfunctions, will be transmitted to the manufacturer for this purpose together with the vehicle identification number if necessary. In addition, the manufacturer is subject to product liability. For this reason, the manufacturer also uses operational data from the vehicle for e.g. recalls. This data can also be used to check customer claims for warranty and guarantee.

Fault memories in the vehicle can be reset by a service outlet or at your request as part of repair or maintenance work.

Comfort and infotainment functions

You can save comfort settings and individualization in the vehicle and change or reset them at any time.

Depending on the vehicle equipment, this includes the following settings, for example:

- Seat positions and steering wheel positions
- Suspension tuning and climate control settings
- Custom settings (e.g. interior lighting)

You can incorporate data into the vehicle's infotainment functions yourself as part of the selected equipment.

Depending on the vehicle equipment, this includes the following data, for example:

- Multimedia data (e.g. music, films or photos for playback in an integrated multimedia system)
- Address book data for use in conjunction with an integrated hands-free system or an integrated navigation system

- Navigation destinations that have been entered
- Data about the use of internet services

This data for comfort and infotainment functions can be saved locally in the vehicle or stored on a device that you have connected to the vehicle (e.g. smartphone, USB flash drive or MP3 player). If you have entered data yourself, you can delete it at any time.

The transfer of this data out of the vehicle will take place exclusively at your request. This applies in particular when you are using online services according to the settings you have selected.

Smartphone integration (e.g. Android Auto or Apple CarPlay®)

If your vehicle is equipped appropriately, you can connect your smartphone or another mobile device to the vehicle. You will then be able to control them using the controls integrated in the vehicle. The smartphone's picture and sound can be output via the multimedia system. Specific items of information will also be transferred to your smartphone. Depending on the type of integra-

tion, this may include position data, day/night mode and other general vehicle statuses. Please refer to the vehicle Operator's Manual / infotainment system operating instructions for further information.

This integration allows the use of selected smartphone apps (e.g. navigation apps, music player apps). There will be no further interaction between your smartphone and the vehicle; in particular, vehicle data will not be directly accessible. The type of additional data processing is determined by the provider of the app being used. Whether you can configure settings for it and, if so, which ones, depend on the app and your smartphone's operating system.

Online services

Wireless network connection

If your vehicle has a wireless network connection, it enables data to be exchanged between your vehicle and additional systems. The wireless network connection is made possible by the vehicle's own transmitter and receiver or by a mobile end device that you have brought into the vehicle, for

example, a smartphone. Online functions can be used via the wireless network connection. This includes online services and applications/apps provided to you by the manufacturer or by other providers.

Manufacturer's services

Regarding the manufacturer's online services, the individual functions are described by the manufacturer in a suitable place, for example, in the Operator's Manual or on the manufacturer's website, where the relevant data protection information is also given. Personal data may be used for the provision of online services. Data is exchanged via a secure connection, such as the manufacturer's designated IT systems. Any personal data which is collected, processed and used, other than for the provision of services, is done so exclusively on the basis of legal permission. This is the case, for example, for a legally prescribed emergency call system, a contractual agreement or when consent has been given.

You can have services and functions, some of which are subject to a fee, activated or deactivated. This excludes legally prescribed functions and services, such as an emergency call system.

Third-party services

If you use online services from other providers (third parties), these services are the responsibility of the provider in question and subject to that provider's data protection conditions and terms of use. As a general rule, the manufacturer has no influence on the content exchanged.

For this reason, when services are provided by third parties, please ask the service provider in question for information about the type, extent and purpose of the collection and use of personal data.

Data protection rights

Depending on your country or the equipment and range of functions of your vehicle as well as the services you use and the services on offer, you are entitled to different data protection rights. Further information on data protection and your data protection rights can either be found on the manufacturer's website or you will receive this information as part of the various services and service offers. There you will also find the contact

information for the manufacturer and its data protection officers.

At a workshop, for example, with the support of a specialist and possibly for a fee, you can have data read out which is stored only locally in the vehicle.

MBUX multimedia system/Mercedes me connect

If the vehicle is equipped with the MBUX multimedia system or Mercedes me connect, additional data about the vehicle's operation, the use of the vehicle in certain situations, and the location of the vehicle may be compiled by the MBUX multimedia system or Mercedes me connect.

For additional information, please refer to the "MBUX multimedia system" section and/or the Mercedes me connect Terms and Conditions.

Event data recorder

USA only:

This vehicle is equipped with an event data recorder (EDR). The main purpose of an EDR is to

record, in certain crash or near crash-like situations, such as an air bag deployment or hitting a road obstacle, data that will assist in understanding how a vehicle's systems performed. The EDR is designed to record data related to vehicle dynamics and safety systems for a short period of time, typically 30 seconds or less.

The EDR in this vehicle is designed to record such data as:

- How various systems in your vehicle were operating;
- Whether or not the driver and passenger safety belts were buckled/fastened;
- How far (if at all) the driver was depressing the accelerator and/or brake pedal; and,
- How fast the vehicle was traveling.

These data can help provide a better understanding of the circumstances in which crashes and injuries occur. NOTE: EDR data are recorded by your vehicle only if a non-trivial crash situation occurs; no data are recorded by the EDR under normal driving conditions and no personal data (e.g., name, gender, age, and crash location) are

recorded. However, other parties, such as law enforcement could combine the EDR data with the type of personally identifying data routinely acquired during a crash investigation.

To read data recorded by an EDR, special equipment is required, and access to the vehicle or the EDR is needed. In addition to the vehicle manufacturer, other parties, such as law enforcement, that have the special equipment, can read the information if they have access to the vehicle or the EDR.

EDR data may be used in civil and criminal matters as a tool in accident reconstruction, accident claims, and vehicle safety. Since the Crash Data Retrieval CDR tool that is used to extract data from the EDR is commercially available, Mercedes-Benz USA, LLC („MBUSA“) expressly disclaims any and all liability arising from the extraction of this information by unauthorized Mercedes-Benz personnel.

MBUSA will not share EDR data with others without the consent of the vehicle owners or, if the vehicle is leased, without the consent of the lessee. Exceptions to this representation include responses to subpoenas by law enforcement; by

federal, state or local government; in connection with or arising out of litigation involving MBUSA or its subsidiaries and affiliates; or, as required by law.

Warning: The EDR is a component of the Restraint System Module. Tampering with, altering, modifying or removing the EDR component may result in a malfunction of the Restraint System Module and other systems.

State laws or regulations regarding EDRs that conflict with federal regulation are pre-empted. This means that in the event of such conflict, the federal regulation governs. As of Dec 2016, 17 states have enacted laws relating to EDRs.

Copyright

Free and open source software

Information on licenses for free and open-source software used in your vehicle can be found on the data carrier in your vehicle document wallet and with updates on the following website:

<https://www.mercedes-benz.com/opensource>



Registered trademarks

- Bluetooth® is a registered trademark of Bluetooth SIG, Inc.
- DTS™ is a registered trademark of DTS, Inc.
- Dolby® and MLP™ are registered trademarks of DOLBY Laboratories.
- ESP® and PRE-SAFE® are registered trademarks of Mercedes-Benz Group AG.
- HomeLink® is a registered trademark of Genex Corporation.
- iPod® and iTunes® are registered trademarks of Apple Inc.
- Burmester® is a registered trademark of Burmester Audiosysteme GmbH.
- Microsoft® and Windows Media® are registered trademarks of Microsoft Corporation.
- SiriusXM® is a registered trademark of Sirius XM Radio Inc.
- HD Radio™ is a registered trademark of iBiquity Digital Corporation.
- Gracenote® is a registered trademark of Gracenote, Inc.
- ZAGAT Survey® and related brands are registered trademarks of Zagat Survey, LLC.

Brief overview of the most important points

Basic information

In particular ensure the following conditions to enable the components of the restraint system to unfold their protective potential:

- Sit correctly (→ page 42).
- Fasten the seat belt correctly (→ page 43).
 - Function of the  seat belt warning lamp (→ page 45).
 - Function of the rear seat belt status display (→ page 45).
- The  restraint system warning lamp has gone out after the self-test (→ page 44).
- The PASSENGER AIR BAG indicator lamps display the correct status of the front passenger air bag (→ page 46).

For clear understanding

The chapter "Occupant safety" includes information on equipment, functions and behaviors that contribute directly to safety of vehicle occupants.

The information is structured as follows:

- **The most important information in brief:** in this chapter, you are provided with an overview of the relationship between the restraint system and the correct behavior of all vehicle occupants.
- **Specific information:** in further sections of the chapter "Occupant safety", you can find specific information on the equipment and functions of the restraint system.
- **Keyword directory:** you can also find certain subjects in this Operator's Manual using the keyword directory.

Information on the following subjects, among others, are not provided in the chapter "Occupant safety":

- Children in the vehicle (→ page 58)
- Driving and driving safety systems (→ page 190)
- Stowage areas (→ page 113)

Defining generic terms clearly

In this Operator's Manual, the following generic terms are used:

- **Occupant safety:** comprises the components and system functions which help to minimize, as much as possible, the stresses on and consequences for vehicle occupants during an accident.
- **Restraint system:** comprises those components which, along with the vehicle structure, help prevent vehicle occupants from potentially coming into contact with parts of the vehicle interior. The seat belts and air bags, for example, are components of the restraint system.
- **Child restraint system:** you can find all information on this subject in the chapter "Children in the vehicle" (→ page 58).

Be diligent

For the components of the restraint system to provide the intended level of protection, it is essential that your posture is correct and that the seat belt is correctly fastened.

Please bear in mind that carelessness regarding the seating position and putting on the seat belt may have serious consequences. Be diligent and make sure that all vehicle occupants are sitting correctly and have fastened their seat belts properly before starting every journey.

Information on the correct seat position

The seat position must be correct in order for the components of the restraint system to provide the intended level of protection.

The seat position influences both the protection provided by the seat belt and the additional protection provided by the air bag.

The correct seat position with an almost upright posture and a correctly fastened seat belt also reduce the risk posed by the air bag when it is deployed.

When choosing the seat, take note of the available space. When you are sitting with the right posture in a nearly upright position, your head should not touch the roof.

⚠ WARNING Risk of injury or death due to an incorrect seat position

If you deviate from the correct seat position, the air bag cannot provide its intended protective function.

Each vehicle occupant must make sure of the following.

- ▶ Put the seat in the correct position.
- ▶ Fasten seat belts correctly. Pregnant women must take particular care to ensure that the lap belt never lies across the abdomen.
- ▶ Observe the following information.

In order for the restraint system to provide the intended level of protection, observe the following information:

- Before starting your journey, adjust your seat correctly (→ page 98).

When doing so, make sure you are able to fasten your seat belt correctly. The shoulder belt strap must be routed forward from the seat belt outlet over the center of your shoulder.

- Keep your distance from the air bags, especially the front air bags. Set the driver's seat and front passenger seat as far back as possible while making sure the seat belt is fastened correctly.
- If persons are sitting on the rear seats, vehicle occupants should maintain a sufficient distance to the parts of the vehicle interior in front of them.
- Make sure there are no people, animals or objects between the vehicle occupants and an air bag.
- If you are the driver, observe the following information on the correct position of the driver's seat (→ page 98).
 - Hold the steering wheel only by the steering wheel rim. This allows the driver's air bag to fully deploy.
- Assume a nearly upright position, with your buttocks as far back as possible in the gap between the seat cushion and seat backrest. This ensures that your back lies as flat and firmly as possible against the seat backrest.

- While driving, do not lean forward and do not lean against the door or side window. You may otherwise be in the deployment area of the air bags.
- Sit with your feet resting on the floor, if possible. Your thighs are slightly supported by the seat cushion

Do not put your feet up on the cockpit, for example. Your feet may otherwise be in the deployment area of the air bag.

- Fasten the seat belt correctly.

Notes on wearing the seat belt correctly

Always fasten your seat belt correctly before starting a journey. A seat belt can provide the best level of protection only if it is worn correctly.

⚠ WARNING Risk of injury or death due to incorrectly fastened seat belt

If the seat belt is not worn correctly, it cannot perform its intended protective function.

In addition, an incorrectly fastened seat belt can also cause injuries, for example, in the event of an accident or when braking or changing direction suddenly.

- ▶ Always ensure that all vehicle occupants have their seat belts fastened correctly and are sitting properly.

⚠ WARNING Risk of injury or death when additional restraint systems are not used for persons with a smaller stature

Persons under 5 ft (1.50 m) tall cannot wear the seat belt correctly without a suitable additional restraint system.

- ▶ Always secure persons under 5 ft (1.50 m) tall in a suitable restraint system.

Each vehicle occupant must observe the following notes in particular:

- The seat belt must not be twisted:

- The shoulder belt strap must be routed forward from the seat belt outlet over the center of your shoulder.
- The shoulder belt strap should neither touch your neck nor be routed under your arm or behind your back.
- The lap belt must be routed as low down across the hips as possible.

In addition, push the lap belt down as far as possible across your hips and pull tight with the shoulder belt strap. Never route the lap belt across your abdomen.

Pregnant women must also take particular care with this.

- The shoulder belt strap and lap belt must fit snugly against the body after being tightened.
- Avoid wearing bulky clothing, e.g. a winter coat.
- Never route the seat belt across sharp, pointed, abrasive or fragile objects.
- Only one person should use each seat belt at any one time.

44 Occupant safety – Brief overview of the most important points

- Never secure objects with a seat belt if the seat belt is also being used by one of the vehicle's occupants.

Also ensure that no objects, e.g. a cushion, are ever placed between a person and the seat.

Fastening and adjusting seat belts

If the seat belt is pulled quickly or sharply, the seat belt retractor locks. The seat belt strap cannot be pulled out any further.

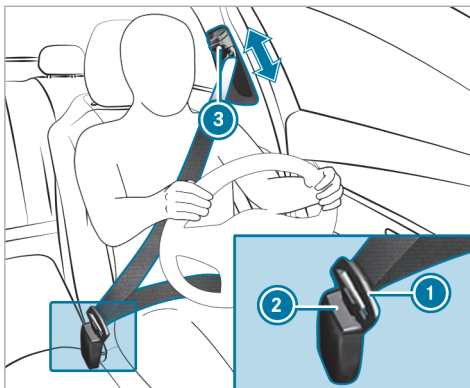

- ▶ Always engage seat belt tongue ① of the seat belt into seat belt buckle ② of the corresponding seat.
- ▶ **To adjust the seat belt height:** press button ③ on the seat belt outlet and slide the seat belt outlet to the desired position.
- ▶ **To engage the seat belt outlet:** release button ③ and ensure that the seat belt outlet engages.

! **NOTE** Deployment of components of the restraint system when the front passenger seat is unoccupied and a seat belt is buckled

When the front passenger seat is unoccupied and the seat belt tongue of the seat belt is engaged in the seat belt buckle, components of the restraint system may deploy unnecessarily on the front passenger side, e.g. the Emergency Tensioning Device.



▶ Only buckle the seat belts as intended.

i Observe the information on the child seat safety feature of the seat belt (→ page 66).

Function of the restraint system warning lamp

When the vehicle is switched on, a self-test will be performed, during which the  restraint system warning lamp will light up. It will disappear no later than a few seconds after the vehicle is started. The components of the restraint system will then be functional.

A malfunction has occurred in the restraint system if:

- the  restraint system warning lamp does not light up or lights up continuously when the vehicle is switched on
- the  restraint system warning lamp lights up continuously or repeatedly during a journey

If components of the restraint system have been deployed, the  restraint system warning lamp will light up continuously.

⚠ WARNING Risk of injury due to malfunctions in the restraint system

Components in the restraint system may be activated unintentionally or not deploy as planned in an accident.

- ▶ Have the restraint system checked and repaired immediately at a qualified specialist workshop.

Mercedes-Benz recommends that you have the vehicle towed to a qualified specialist workshop.

Function of the seat belt warning lamp

The  seat belt warning lamp on the driver display alerts you to the fact that the driver and/or front passenger are not wearing their seat belts.

The  seat belt warning lamp lights up for six seconds every time the vehicle is started.

All vehicle occupants must fasten their seat belts correctly (→ page 43).

In addition, a warning tone may sound.

When the driver's and front passenger doors are closed and the driver and front passenger have fastened their seat belts, the seat belt warning will go out.

In the following cases, the seat belt warning will light up during a journey if:

- The driver or front passenger has not fastened their seat belt and the following criteria apply:
 - The vehicle speed exceeds 5 mph (9 km/h) for more than 20 seconds.
 - The vehicle speed exceeds 15 mph (25 km/h) once.

- The driver or front passenger unfastens their seat belt while the vehicle is in motion.

Function of the rear seat belt status display

The rear seat belt status display in the driver's display is a reminder that all vehicle occupants must wear their seat belts correctly.

In addition, a warning tone may sound.

If a person unfastens a seat belt in the rear passenger compartment while the vehicle is in motion, the rear seat belt status display appears again.

Display in the driver's display

Every time the vehicle is switched on, the rear seat belt status display informs you for a certain amount of time which rear seat belt is not fastened.



You can determine the status of the rear seat belt by the color of the seat symbol in the driver's display as follows:

- Gray: the rear seat belt is not fastened.
- Green: the seat belt tongue of a rear seat belt is engaged in the seat belt buckle of the displayed seat.
- Red: the person in the rear seat has unfastened their seatbelt.

Function of the PASSENGER AIR BAG indicator lamps (front passenger air bag)



The PASSENGER AIR BAG indicator lamps display the status of the front passenger air bag.

If the front passenger seat is occupied or a child restraint system is mounted on the front passenger seat, you must ensure, both before and during the journey, that the status of the front

passenger air bag is correct for the current situation.

⚠ WARNING Risk of potentially fatal injuries due to objects trapped under the front passenger seat

Objects trapped under the front passenger seat may interfere with the function of the automatic front passenger air bag shutoff or damage the system.

- ▶ Do not stow any objects under the front passenger seat.
- ▶ When the front passenger seat is occupied, ensure that no objects have become trapped beneath the front passenger seat.

Self-test: when the vehicle is switched on, both the PASSENGER AIR BAG ON and OFF indicator lamps will light up simultaneously for several seconds.

After the self-test, you can determine the status of the front passenger air bag as follows:

- **Front passenger air bag disabled:** PASSENGER AIR BAG OFF lights up continuously.

The front passenger air bag will not be deployed in the event of an accident. If PASSENGER AIR BAG OFF is lit, no one may use the front passenger seat.

If a rearward-facing child restraint system is installed on the front passenger seat, PASSENGER AIR BAG OFF must be lit continuously.

- **Front passenger air bag enabled:** PASSENGER AIR BAG ON lights up for up to 60 seconds or until both the PASSENGER AIR BAG ON and OFF indicator lamps go out.

The front passenger air bag may be deployed during an accident. If the front passenger air bag has this status, a rearward-facing child restraint system must not be installed on the front passenger seat.

- ① If you are driving with a child in the vehicle, observe the information in the chapter entitled "Children in the vehicle" (→ page 58)

⚠ WARNING Risk of injury or death due to a disabled front passenger airbag

The front passenger airbag is disabled when the PASSENGER AIR BAG OFF indicator lamp is lit.

A person in the front passenger seat could then, for example, come into contact with the vehicle interior, especially if the person is sitting too close to the cockpit.

If the front passenger seat is occupied, always ensure that:

- The classification of the person in the front passenger seat is correct and the front passenger airbag is enabled or disabled in accordance with the person in the front passenger seat.
- The front passenger seat has been moved as far back as possible.

- The person is seated correctly.
- ▶ Both before and during the journey, ensure that the status of the front passenger airbag is correct.

Malfunction on automatic front passenger air bag shutoff

The PASSENGER AIR BAG OFF indicator lamp and the  restraint system warning lamp light up simultaneously.

In this case, no one may use the front passenger seat and no child restraint system may be installed on the front passenger seat.

Have the automatic front passenger air bag shutoff checked and repaired immediately at a qualified specialist workshop.

Be sure to also observe the following further related topics:

- Child restraint system on the front passenger seat (→ page 62)

Disabling or enabling the front passenger air bag

The automatic front passenger air bag shutoff can disable or enable the front passenger air bag according to the situation.

This happens automatically as a result of the classification of the person or child restraint system on the front passenger seat.

You cannot manually disable or enable the front passenger air bag.

Also observe the following information:

- For the status of the front passenger air bag, see "Function of the PASSENGER AIR BAG indicator lamps" (→ page 46)
- For information on using the automatic front passenger air bag shutoff, see "Information on the automatic front passenger air bag shutoff" (→ page 48)
- If you are driving with a child in the vehicle, observe the chapter "Children in the vehicle" (→ page 58)

Information on the child restraint system

When installing a child restraint system, observe the notes in "Children in the vehicle" (→ page 58).

Notes on the child restraint system on the front passenger seat

⚠ WARNING Risk of injury or fatal injuries if the front passenger air bag is enabled

If the front passenger air bag is enabled, a child on the front passenger seat may be struck by the front passenger air bag in the event of an accident.

▶ NEVER use a rearward-facing child restraint system on a seat with an ENABLED FRONT AIR BAG. This can result in the DEATH of or SERIOUS INJURY to the CHILD.

Also pay particular attention to the notes on rearward-facing or forward-facing child restraint systems on the front passenger seat (→ page 62).

Information on the automatic functions of the restraint system

Function of automatic front passenger air bag shutoff

A person on the front passenger seat must observe the following instructions:

- Sit correctly (→ page 42).
- Fasten seat belts correctly (→ page 43).

The automatic front passenger air bag shutoff can disable or enable the front passenger air bag according to the situation.

Make sure you observe the following information:

- The status of the front passenger air bag; see "Function of the PASSENGER AIR BAG indicator lamps" (→ page 46).
- When installing a child restraint system on the front passenger seat, observe the vehicle-specific information (→ page 62).

Status of the front passenger air bag in relation to the stature of the person:

- **Front passenger air bag disabled:** PASSENGER AIR BAG OFF lights up continuously.
The front passenger air bag will not be deployed in the event of an accident. If PASSENGER AIR BAG OFF is lit, no one may use the front passenger seat.

- **Front passenger air bag enabled:** PASSENGER AIR BAG ON lights up for up to 60 seconds or until both the PASSENGER AIR BAG ON and OFF indicator lamps go out.

The front passenger air bag may be deployed during an accident. Observe the following information on the correct seat position (→ page 42).

Vehicles with rear seats: a person of smaller stature should use a rear seat.

System limits

The front passenger air bag may otherwise be disabled by mistake, e.g. in the following situation:

- The front passenger transfers their weight by supporting themselves on a vehicle armrest.
- The front passenger sits in such a way that their weight is raised from the seat surface.

! **NOTE** Deployment of components of the restraint system when the front passenger seat is unoccupied

In an accident, the components of the restraint system may deploy unnecessarily on the front passenger side if:

- There are heavy objects on the front passenger seat.
- The seat belt tongue is engaged in the seat belt buckle of the front passenger seat and the front passenger seat is unoccupied.

- ▶ Store objects in a suitable place.
- ▶ Only one person should use each seat belt at any one time.

Depending on the detected accident situation, the window air bag on the front passenger side may deploy. The air bag will be deployed regardless of whether the front passenger seat is occupied.

Function of PRE-SAFE® (anticipatory occupant protection)

PRE-SAFE® is able to detect certain critical driving situations and implement pre-emptive measures to protect the vehicle occupants.

PRE-SAFE® can implement the following measures independently of each other:

- tightening the seat belts on the driver's seat and front passenger seat.
- closing the side windows.
- **Vehicles with sliding sunroof:** closing the sliding sunroof.
- **Vehicles with memory function:** moving the front passenger seat to a more favorable seat position.

- **Vehicles with multicontour seat:** increasing the lateral support by inflating the seat side bolsters of the seat backrest.
- **PRE-SAFE® Sound:** provided that the multimedia system is switched on, generating a brief noise signal to stimulate the innate protective mechanism of a person's hearing.

! **NOTE** Damage caused by objects in the footwell or behind the seat

The automatic adjustment of the seat position may result in damage to the seat and/or the object.

- ▶ Stow objects in a suitable place.

Reverting the PRE-SAFE® system measures

If an accident did not occur, the pre-emptive measures that were taken will be reversed.

You will need to perform certain settings yourself.

- ▶ If the seat belt pre-tensioning is not reduced, move the seat backrest back slightly. The locking mechanism will release.

Function of PRE-SAFE® PLUS (anticipatory occupant protection plus)

PRE-SAFE® PLUS can detect certain impacts, particularly an imminent rear impact, and take pre-emptive measures to protect the vehicle occupants. These measures may not necessarily prevent an imminent impact.

PRE-SAFE® PLUS can implement the following measures independently of each other:

- Tightening the seat belts on the driver's seat and front passenger seat.
- Increasing brake pressure when the vehicle is stationary. This brake application is canceled automatically when the vehicle pulls away.

If an accident did not occur, the pre-emptive measures that were taken will be reversed.

System limits

The system will not initiate any action in the following situations:

- If the vehicle is backing up
or

- When the vehicle is towing a trailer and there is a risk of a rear-end collision

The system will not initiate a brake application in the following situations:

- During a journey
or
- When the vehicle is entering or exiting a parking space using Active Parking Assist

Function of PRE-SAFE® Impulse Side

If an imminent side impact is detected, PRE-SAFE® Impulse Side can pre-emptively move the front seat vehicle occupant's upper body towards the center of the vehicle. It does this by rapidly inflating an air cushion in the outer seat side bolster of the seat backrest on the side on which the impact is anticipated. This increases the distance between the door and the vehicle occupant.

If PRE-SAFE® Impulse Side has been deployed or is faulty, a display message reading **PRE-SAFE Pulse Side Inoperative** See [Operator's Manual](#) (→ page 420) will appear.

Seat belt adjustment function

Vehicles with PRE-SAFE®: after a front seat belt has been fastened, the automatic seat belt adjustment may apply a certain tightening force by gently pulling taut from the shoulder. Do not hold onto the seat belt while it is adjusting.

You can activate and deactivate the seat belt adjustment function using the multimedia system.

Activating/deactivating seat belt adjustment via the multimedia system

Multimedia system:

→  » Settings » Vehicle
» Occupant Protection

▶ Activate or deactivate **Belt adjustment**.

Overview of automatic measures after an accident

Depending on the type and severity of the accident, and depending on the vehicle's equipment, the following measures may be implemented, for example:

- automatic braking (post-collision brake)
- activating the hazard warning lights
- triggering an automatic emergency call (→ page 320)
- switching off the engine

To start the vehicle again, switch the vehicle off and back on (→ page 156). Depending on the type and severity of the accident, the vehicle may no longer start.

- shutting off the fuel supply
- unlocking the vehicle doors
- lowering the side windows
- displaying the emergency guide on the central display
- switching on the interior lighting

Function of the post-collision brake after an accident

Depending on the accident situation, the post-collision brake can minimise the severity of a further collision or even avoid it.

If an accident is detected, the post-collision brake can initiate automatic braking. When the vehicle has come to a standstill, the electric parking brake is automatically applied.

The driver can cancel automatic braking by taking the following actions:

- Braking more strongly than automatic braking
- Fully depressing the accelerator pedal with force

Purpose and function of the restraint system

Overview of deployment situations (restraint system)

Make sure that the following prerequisites in particular have been met so that the components of the restraint system are able to provide the intended level of protection:

- Sit correctly (→ page 42).
- Fasten the seat belt correctly (→ page 43).
 - Function of the seat belt warning lamp (→ page 45).
 - Function of the rear seat belt status display (→ page 45).
- The restraint system warning lamp  is not lit up after the self-test (→ page 44).
- The PASSENGER AIR BAG indicator lamps display the correct status of the front passenger air bag (→ page 46).

Depending on the detected deployment situation, the components of the restraint system can be activated or deployed independently of each other:

- Emergency Tensioning Device: frontal impact, rear impact, side impact, rollover
- Driver's air bag, front passenger air bag: frontal impact
- Knee air bag: frontal impact
- Side impact air bag: side impact
- Window curtain air bag: side impact, rollover, frontal impact
- PRE-SAFE® Impulse Side: side impact

The installation location of an air bag is identified by the AIRBAG symbol (→ page 57).

Observe the information on the function of the restraint system (→ page 52).

Information on how the restraint system works

The function of the restraint system depends on the severity of the impact detected and the apparent type of accident.

For more information about types of accidents, see "Overview of deployment situations" (→ page 52).

The activation thresholds for the components of the restraint system are determined based on the evaluation of the sensor values measured at various points in the vehicle. This process is pre-emptive in nature. The triggering of the components of the restraint system must take place in good time at the start of the impact.

Factors that can be seen and measured only after a collision has occurred do not play a decisive role in the deployment of an air bag, nor do they provide an indication of air bag deployment.

The vehicle may be deformed significantly without an air bag being deployed. This is the case if only parts that are relatively easily deformed are affected and the rate of vehicle deceleration is not high. Conversely, an air bag may be deployed even though the vehicle suffers only minor defor-

mation. If very rigid vehicle parts, such as longitudinal members, are hit, the vehicle deceleration may be high enough for this to happen.

Depending on the apparent type of accident and the detected deployment situation, Emergency Tensioning Devices and/or air bags supplement the protection offered by a correctly worn seat belt.

When enabled, an air bag can provide additional protection for the respective vehicle occupant.

Potential protection provided by each air bag:

- Knee air bag: thighs, knees and lower legs
- Driver's air bag, front passenger air bag: head and ribcage
- Window air bag: head
- Side air bag: ribcage and pelvis

However, no system available today can completely eliminate injuries and fatalities in every accident situation. In particular, the seat belt and air bag generally do not protect against objects penetrating the vehicle from the outside. It is also not possible to completely rule out the risk of injury caused by the air bag deploying.

Mercedes-Benz recommends that you have the vehicle towed to a qualified specialist workshop after an accident. Take this into account, particularly if a Emergency Tensioning Device has been triggered or an air bag deployed.

If the Emergency Tensioning Devices are triggered or an air bag is deployed, you will hear a bang, and a small amount of fine powder may also be released:

- The bang will not generally affect your hearing.
- In general, the fine powder released is not hazardous to health but may cause short-term breathing difficulties to persons suffering from asthma or other respiratory problems.

Provided it is safe to do so, leave the vehicle immediately or open the window in order to prevent breathing difficulties.

Air bags and pyrotechnic Emergency Tensioning Devices contain perchlorate material, which may require special handling or environmental protection measures. National guidelines regarding waste disposal must be observed. In California, see <https://dtsc.ca.gov/>. You can use the search

function to find information on perchlorate, for example.

Information on the limited protection provided by the restraint system

Risk due to the incorrect behavior of vehicle occupants

Every vehicle occupant must make sure of the following in particular:

- They observe the information on the correct seat position (→ page 42).
- There are no heavy, sharp-edged or fragile objects in the pockets of their clothing. Store such objects in a suitable place.

⚠ WARNING Risk of injury or death due to an incorrect seat position

The seat belt does not offer the intended level of protection if you have not moved the seat backrest to an almost vertical position.

In particular, you could slip beneath the seat belt and become injured.

- ▶ Adjust the seat properly before beginning your journey.
- ▶ Always ensure that the seat backrest is in an almost vertical position and that the shoulder belt is routed across the center of your shoulder.

Risk due to objects in the vehicle interior

Every vehicle occupant must make sure of the following in particular:

- They observe the information on the correct seat position (→ page 42).
- There are no objects between the seat, door and door pillar (B-pillar).
- There are no hard objects, e.g. coat hangers, hanging on the grab handles or coat hooks.
- There are no heavy, sharp-edged or fragile objects in the pockets of their clothing. Store such objects in a suitable place.

⚠ WARNING Risk of injury or death due to blocked seat belt buckle or seat belt anchorage

Objects next to the front seat that block the seat belt buckle or the moving seat belt anchorage on the front seat impair the function of the Emergency Tensioning Devices.

- ▶ Before starting the journey, make sure that there are no objects around the seat belt buckle or between the front seat and door.

⚠ WARNING Risk of injury from objects in the deployment area of an airbag

Objects in the deployment area of an airbag can hinder or prevent the correct deployment of the airbag.

The airbag may then deploy in an uncontrolled manner and may even cause additional injuries to the vehicle occupants by deploying. This may be the case in particular if the airbag is integrated into the seat.

- ▶ Always stow and secure objects correctly.
- ▶ Before commencing your journey, make sure that no objects are stowed in the deployment area of an airbag.

The installation location of an air bag is identified by the AIRBAG (→ page 57) symbol.

Risk due to installation of accessories

Do not attach accessories such as mobile navigation devices, mobile phones or cup holders within the deployment area of an air bag, e.g. on the cockpit, on the door, on the side window or on the side trim.

In addition, no connecting cables, tensioning straps or retaining straps may be routed or attached to the vehicle within the deployment area of an air bag. Always comply with the accessory manufacturer's installation instructions and, in particular, the notes on suitable places for installation.

▲ WARNING Risk of injury or death due to unsuitable protective covers

Unsuitable protective covers mean that air bags can no longer protect vehicle occupants as they are designed to do.

- ▶ Use only protective covers approved by Mercedes-Benz for the seat in question.

In addition, the function of the automatic front passenger air bag shutoff could be restricted due to an unsuitable protective cover. If the front passenger seat is occupied, ensure that the PASSENGER AIR BAG indicator lamps display the correct status of the front passenger air bag (→ page 46).

Risk due to pets in the vehicle interior

▲ WARNING Risk of accident and injury due to animals left unsecured or unattended in the vehicle

If you leave animals in the vehicle unattended or unsecured, they could possibly press buttons or switches.

An animal may:

- Activate vehicle equipment and become trapped, for example
- Switch systems on or off and endanger other road users

Unsecured animals may be thrown around in the vehicle in the event of an accident or sudden steering and braking maneuvers and injure vehicle occupants in the process.

- ▶ Never leave animals in the vehicle unattended.
- ▶ Always correctly secure animals while driving, e.g. using a suitable animal carrier.

Risk due to modification, damage or wear to the components of the restraint system

▲ WARNING Risk of injury or death due to modifications to the restraint system

Vehicle occupants may no longer be protected as intended if alterations are made to the restraint system.

- ▶ Never alter the parts of the restraint system.
- ▶ Never tamper with the wiring or any electronic component parts or their software.

If it is necessary to modify the vehicle to accommodate a person with disabilities, contact an authorized Mercedes-Benz Center for details.

USA only: for details, contact our Customer Assistance Center on 1-800-FOR-MERCEdes (1-800-367-6372).

▲ WARNING Risk of injury or death due to damaged or modified seat belts

Seat belts cannot provide protection in the following situations:

- The seat belt is damaged, has been modified, is extremely dirty, bleached or dyed
- The seat belt buckle is damaged or extremely dirty

- Modifications have been made to the Emergency Tensioning Device, seat belt anchorage or seat belt retractor

Seat belts may sustain non-visible damage in an accident, e.g. due to glass splinters.

Modified or damaged seat belts could tear or fail in the event of an accident, for example.

Modified Emergency Tensioning Devices could accidentally trigger or fail to function as intended.

- ▶ Never modify the seat belt system, for example the seat belt, seat belt buckle, Emergency Tensioning Device, seat belt anchorage and seat belt retractor.
- ▶ Make sure that the seat belts are undamaged, not worn and clean.
- ▶ Always have the seat belts checked immediately after an accident at a qualified specialist workshop.

Use only seat belts that have been approved for your vehicle by Mercedes-Benz.

⚠ WARNING Risk of injury due to modifications to the cover of an airbag

If you change the cover of an airbag or attach objects, e.g. even stickers, to it, the airbag may no longer function as intended.

- ▶ Never modify the cover of an airbag.
- ▶ Do not attach any objects to the cover.

The installation location of an air bag is identified by the AIRBAG symbol (→ page 57).

⚠ WARNING Risk of injury due to malfunctioning sensors in the door

The function of the airbags can be impaired due to modifications or incorrect work performed on the doors or door trim, or if the doors are damaged.

- ▶ Never modify the doors or parts of the doors.
- ▶ Always have work on the doors or door trim carried out at a qualified specialist workshop.

Risk due to components of the restraint system that have already been deployed

Mercedes-Benz recommends that you have the vehicle towed to a qualified specialist workshop after an accident.

⚠ WARNING Risk of burns from hot air bag components

The air bag parts are hot after an air bag has been deployed.

- ▶ Do not touch the air bag parts.
- ▶ Have a deployed air bag replaced at a qualified specialist workshop as soon as possible.

⚠ WARNING Risk of injury due to deployed airbag

A deployed airbag no longer offers any protection.

- ▶ Have the vehicle towed to a qualified specialist workshop in order to have the deployed airbag replaced.

Have deployed air bags replaced immediately.

⚠ WARNING Risk of injury or death from deployed pyrotechnic Emergency Tensioning Devices

Pyrotechnic Emergency Tensioning Devices that have been deployed are no longer operational and are unable to perform their intended protective function.

▶ Therefore, have deployed pyrotechnic Emergency Tensioning Devices immediately replaced at a qualified specialist workshop.

Seat belts

Releasing the seat belts

▶ Press the release button in the seat belt buckle and guide the seat belt back with the seat belt tongue.

! NOTE Damage caused by trapping the seat belt

If an unused seat belt is not fully retracted, it may become trapped in the door or in the seat mechanism.

▶ Always ensure that an unused seat belt is fully retracted.

Airbags

Overview of air bags

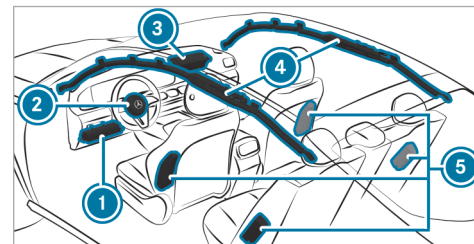

- ① Driver's knee air bag
- ② Driver's air bag
- ③ Front passenger air bag
- ④ Window curtain air bag
- ⑤ Side impact air bag

The installation location of an air bag is identified by the AIRBAG symbol.

Observe the information under "Overview of deployment situations" (→ page 52).

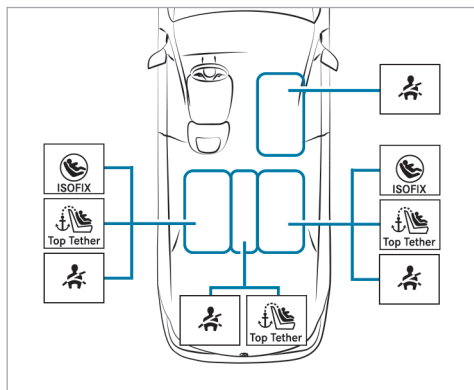
Key facts in brief**Safely transporting children in the vehicle**



Always observe the following when transporting children:

- Never leave children unattended in the vehicle (→ page 60).



- Secure children younger than twelve or of a height up to 5 ft (1.50 m) on the seat (see illustration above) properly with a suitable and approved child restraint system and secure small children in a rearward-facing child restraint system.
- Observe the child restraint system manufacturer's installation instructions.

Left/right rear seat (preferred seats)

Preferred fastening system:

-  ISOFIX mounting brackets (→ page 67)
-  and additionally fasten Top Tether if available (→ page 68).

Alternative attachment system:

-  Vehicle seat belt (→ page 70)
-  Additionally fasten Top Tether if recommended by the manufacturer of the child restraint system (→ page 68).

Front passenger seat

Fastening system:



-  Vehicle seat belt (→ page 70)

Be sure to observe:

- If the front passenger seat is occupied, ensure that the status of the front passenger air bag is correct for the current situation (→ page 46).

Center rear seat

Fastening system:

-  Vehicle seat belt (→ page 70)
-  Additionally fasten Top Tether if recommended by the manufacturer of the child restraint system (→ page 68).

Important safety notes**Basic information****Be diligent**

Bear in mind that negligence when securing a child in the child restraint system may have seri-

ous consequences. Always be diligent in securing a child carefully before every journey.

Never allow babies and children to travel sitting on the lap of another vehicle occupant.

To improve protection for children younger than twelve years old or under 5 ft (1.50 m) in height, Mercedes-Benz recommends you observe the following information:

- Always secure the child in a child restraint system suitable for this Mercedes-Benz vehicle.
- The child restraint system must be appropriate to the age, weight and size of the child.
- The vehicle seat must be suitable for the child restraint system to be installed:

Accident statistics show that children secured on the rear seats are generally safer than children secured on the front seats. For this reason, Mercedes-Benz strongly advises that you install a child restraint system to a rear seat.

The generic term child restraint system

The generic term child restraint system is used in this Operator's Manual. A child restraint system is, for example:

- a baby car seat
- a rearward-facing child seat
- a forward-facing child seat
- a child booster seat – Mercedes-Benz recommends using a child booster seat **with** a seat backrest and seat belt guide.

Observe laws and legal requirements

Always observe the legal requirements when using a child restraint system in the vehicle.

Securing systems for child restraint systems in the vehicle

Use only the following securing systems for child restraint systems:

- The ISOFIX mounting bracket
- The vehicle's seat belt system
- The Top Tether anchorages

Simply attaching to the ISOFIX mounting brackets on the vehicle can reduce the risk of installing the child restraint system incorrectly.

When securing a child with the integrated seat belt of the ISOFIX/LATCH child restraint system, always comply with the permissible gross weight for the child and child restraint system (→ page 67).

A child booster seat may be necessary to achieve proper seat belt positioning for children over 40 lbs (18 kg) in weight or until they reach a height where a three-point seat belt can be installed properly without a child booster seat.

Mercedes-Benz recommends a suitable child booster seat with a backrest and seat belt guide.

Observe standards for child restraint systems

All child restraint systems must meet the following standards:

- U.S. Federal Motor Vehicle Safety Standards 213
- Canadian Motor Vehicle Safety Standards 213

Confirmation that the child restraint system complies with the standards can be found on an information label on the child restraint system. This confirmation can also be found in the installation instructions that are included with the child restraint system.

Important warning stickers

Always secure a child restraint system correctly

⚠ WARNING Risk of injury or death due to incorrect installation of the child restraint system

The child can then not be protected or restrained as intended.

- ▶ Be sure to comply with the manufacturer's installation instructions for the child restraint system and its correct use.
- ▶ Make sure that the entire base of the child restraint system always rests on the sitting surface of the seat.

- ▶ Never place objects (e.g. cushions) under or behind the child restraint system.
- ▶ Use child restraint systems only with the original cover designed for them.
- ▶ Always replace damaged covers with genuine covers.

- Always observe the vehicle-specific information.
 - Installing the ISOFIX/LATCH child restraint system on the right and left rear seats (→ page 67).
 - Securing the child restraint system with the seat belt (→ page 70).
- Observe the warning labels in the vehicle interior and on the child restraint system.

⚠ WARNING Risk of injury or death due to unsecured child restraint systems in the vehicle

If the child restraint system is incorrectly mounted or unsecured, it may come loose.

The child can then not be protected or restrained as intended.

Unused child restraint systems could be flung around and hit vehicle occupants.

- ▶ Always comply with the manufacturer's installation instructions for the child restraint system and its correct use.
- ▶ Always fit child restraint systems correctly, even if they are transported in the vehicle unused.

Do not modify the child restraint system

⚠ WARNING Risk of injury due to modifications to the child restraint system

The child restraint system can no longer function properly. This poses an increased risk of injury.

- ▶ Never modify a child restraint system.
- ▶ Only affix accessories which have been specially approved for this child restraint system by the child restraint system's manufacturer.

Only use child restraint systems which are in proper working condition

⚠ WARNING Risk of injury or death caused by the use of damaged child restraint systems

Child restraint systems or their retaining systems that have been subjected to stress in an accident may not be able to perform their intended protective function.

It may be the case that the child cannot be properly restrained.

- ▶ Always immediately replace child restraint systems that have been damaged or involved in an accident.
- ▶ Have the securing systems for the child restraint systems checked at a qualified specialist workshop before installing a child restraint system again.

Avoid direct sunlight

⚠ WARNING Risk of burns when the child seat is exposed to direct sunlight

If the child restraint system is exposed to direct sunlight or heat, parts could heat up excessively.

Children could suffer burns from these parts, particularly the metallic parts of the child restraint system.

- ▶ Always make sure that the child restraint system is not exposed to direct sunlight.
- ▶ Cover the child restraint system with a blanket, for example.
- ▶ If the child restraint system has been exposed to direct sunlight, allow it to cool before securing a child into it.
- ▶ Never leave children unattended in the vehicle.

Observe when stopping or parking

⚠ WARNING Risk of fatal injury due to exposure to extreme heat or cold in the vehicle

If persons, particularly children, are subjected to prolonged exposure to intense heat or cold, there is a risk of severe injury or even death.

- ▶ Never leave persons, particularly children, unattended in the vehicle.

⚠ WARNING Risk of accident and injury if children are left unattended in the vehicle

If children are left unattended in the vehicle, they could in particular:

- open doors, thereby endangering other persons or road users.
- get out and be struck by oncoming traffic.
- operate vehicle equipment and become trapped, for example.

In addition, the children could also set the vehicle in motion, for example by:

- releasing the parking brake.
- changing gear.
- starting the vehicle.

- ▶ Never leave children unattended in the vehicle.
- ▶ When leaving the vehicle, always take the SmartKey with you and lock the vehicle.
- ▶ Keep the SmartKey out of the reach of children.

Notes on rearward-facing and front-facing child restraint systems on the front passenger seat

▲ WARNING Risk of injury or fatal injury when using a rearward-facing child restraint system while the co-driver airbag is enabled

If you secure a child in a rearward-facing child restraint system on the co-driver seat and the

PASSENGER AIR BAG OFF indicator lamp is off, the co-driver airbag can deploy in the event of an accident.

The child could be struck by the airbag.

- ▶ Always ensure that the co-driver airbag is disabled. The PASSENGER AIR BAG OFF indicator lamp must be lit.
- ▶ NEVER use a rearward-facing child restraint system on a seat with an ENABLED FRONT AIRBAG; DEATH or SERIOUS INJURY to the CHILD can occur.

Observe the specific instructions for the rearward-facing and forward-facing child restraint systems (→ page 64).

If it is absolutely necessary to install a child restraint system on the front passenger seat, always observe the following information:

- When a rearward-facing child restraint system is used on the front passenger seat, the front passenger air bag must always be disabled. This is the case only if the PASSENGER AIR

BAG OFF indicator lamp is lit continuously (→ page 46).

- The front passenger air bag is enabled when the PASSENGER AIR BAG OFF indicator lamp is not lit. The front passenger air bag may be deployed during an accident. In that case, do not use rearward-facing child restraint systems.

Information on the automatic front passenger air bag shutoff

If the front passenger seat is occupied, ensure, both before and during the journey, that the status of the front passenger air bag is correct for the current situation.

▲ WARNING Risk of injury or death due to objects between the seat surface and the child restraint system

Objects between the seat surface and the child restraint system can interfere with the function of the automatic front passenger air bag shutoff.

- ▶ Do not place any objects between the seat surface and the child restraint system.
- ▶ Make sure that the entire base of the child restraint system rests on the seat cushion of the front passenger seat.
- ▶ The backrest of a forward-facing child restraint system must, as far as possible, be resting against the seat backrest of the front passenger seat.
- ▶ Always comply with the installation instructions from the child restraint system manufacturer.

When installing a child restraint system to the front passenger seat, observe the vehicle-specific information (→ page 62).

Rearward-facing child restraint system on the front passenger seat

If a rearward-facing child restraint system is installed on the front passenger seat, the front passenger air bag must be deactivated. The PASSENGER AIR BAG OFF indicator lamp must light up continuously (→ page 46).

⚠ WARNING Risk of injury or fatal injury when using a rearward-facing child restraint system while the co-driver airbag is enabled

If you secure a child in a rearward-facing child restraint system on the co-driver seat and the PASSENGER AIR BAG OFF indicator lamp is off, the co-driver airbag can deploy in the event of an accident.

The child could be struck by the airbag.

- ▶ Always ensure that the co-driver airbag is disabled. The PASSENGER AIR BAG OFF indicator lamp must be lit.
- ▶ NEVER use a rearward-facing child restraint system on a seat with an ENABLED FRONT AIRBAG; DEATH or SERIOUS INJURY to the CHILD can occur.

- ⓘ The front passenger air bag is enabled depending on the child restraint system and the stature of the child. The PASSENGER AIR BAG OFF indicator lamp does not light up. The front passenger air bag may be deployed during an accident. If the front passenger air

bag is in this status, no rearward-facing child restraint system may be installed on the front passenger seat. Instead, install the rearward-facing child restraint system on a suitable rear seat.

Forward-facing child restraint system on the front passenger seat

If a forward-facing child restraint system is installed on the front passenger seat, the front passenger air bag may be automatically enabled or disabled. The status of the front passenger air bag depends on the child restraint system and the stature of the child.

The PASSENGER AIR BAG OFF indicator lamp is either lit continuously, or it is not lit (→ page 46). Always observe the following information.

⚠ WARNING Risk of injury or death due to incorrect positioning of the child restraint system

If you secure a child in a forward-facing child restraint system on the co-driver seat and you position the co-driver seat too close to the dashboard, in the event of an accident, the child could:

- come into contact with the vehicle's interior if the PASSENGER AIR BAG OFF indicator lamp is lit, for example
- be struck by the airbag if the PASSENGER AIR BAG OFF indicator lamp is off

▶ Always move the co-driver seat as far back as possible. In doing so, always make sure that the shoulder belt strap is correctly routed from the seat belt outlet of the vehicle to the shoulder belt guide on the child restraint system. The shoulder belt strap must be routed forwards and downwards from the seat belt outlet.

If necessary, adjust the seat belt outlet and the co-driver seat accordingly.

▶ Always comply with the child restraint system manufacturer's installation instructions.

Be sure to also observe the following further related topics:

- Function of the automatic front passenger air bag shut-off (→ page 46)

Suitable child restraint systems for the transport of children

Information on the advantage of a rearward-facing child restraint system

Transport a baby in a suitable rearward-facing child restraint system only. It is also preferable to transport a small child in a suitable rearward-facing child restraint system. In this case, the child sits in the opposite direction to the direction of travel and faces backwards.

Babies and small children have comparatively weak neck muscles in relation to the size and weight of their head. The risk of injury to the cervical spine during an accident can be reduced in a rearward-facing child restraint system.

Securing the child restraint system

Adjusting the seat correctly

When installing a child restraint system on the left or right rear seat, always observe the following:

▶ Make sure that the child's feet do not touch the front seat. If necessary, move the front seat slightly forwards.

If the head restraint of the child restraint system cannot be fully extended when it is installed in the vehicle, this will result in restrictions on the maximum size setting for certain child restraint systems. Observe the child restraint system manufacturer's installation instructions.

ⓘ Contact with the roof when the head restraint is fully extended and locked in place will not result in any restrictions on use.

 Also observe the following when installing an ISOFIX child restraint system:

- ▶ **When using a rearward-facing child restraint system on a rear seat:** adjust the front seat such that it does not touch the child restraint system.
- ▶ **When using a forward-facing child restraint system with integrated child seat belt:** adjust the head restraint of the respective seat such that it does not push the child restraint system forwards. If necessary, the corresponding head restraint can be removed. In addition, the seat backrest of the child restraint system must lie as flat as possible against the backrest of the vehicle seat. After the child restraint system has been removed, replace the vehicle head restraint immediately and adjust it correctly.
- ▶ The child restraint system must not be put under strain between the roof and the seat cushion and/or be installed facing in the wrong direction. Where possible, adjust the seat cushion angle accordingly.

- ▶ Adjust the vehicle head restraints such that the child restraint system is not put under strain by the head restraint.

 **When installing a belt-secured child restraint system, also observe the following:**

- ▶ **When using a rearward-facing child restraint system on a rear seat:** adjust the front seat such that it does not touch the child restraint system.
- ▶ Additionally fasten Top Tether if present (→ page 68).
- ▶ **When using a forward-facing child restraint system with integrated child seat belt:** adjust the head restraint of the respective seat such that it does not push the child restraint system forwards. If necessary, the corresponding head restraint can be removed. In addition, the seat backrest of the child restraint system must lie as flat as possible against the backrest of the vehicle seat. After the child restraint system has been removed, replace the vehicle head restraint immediately and adjust it correctly.

- ▶ The backrest of the forward-facing child restraint system must, as far as possible, be resting on the seat backrest of the rear seat.
- ▶ The child restraint system must not be put under strain between the roof and the seat cushion and/or be installed facing in the wrong direction. Where possible, adjust the seat cushion angle accordingly.
- ▶ Adjust the vehicle head restraints such that the child restraint system is not put under strain by the head restraint.
- ▶ Make sure that the child's feet do not touch the front seat. If necessary, move the front seat slightly forwards.

 **Depending on the vehicle equipment, always observe the following when installing a belt-secured child restraint system on the front passenger seat:**

- ▶ Observe the notes on rearward-facing and forward-facing child restraint systems on the front passenger seat (→ page 62).
- ▶ **When using a forward-facing child restraint system integrated child seat belt:** remove the

head restraint from the front passenger seat, if possible. After the child restraint system has been removed, immediately replace the head restraint and adjust it correctly.

- ▶ The backrest of the forward-facing child restraint system must, as far as possible, be resting on the seat backrest of the front passenger seat.
- ▶ The child restraint system must not be put under strain between the roof and the seat cushion and/or be installed facing in the wrong direction.
- ▶ Adjust the vehicle head restraints such that the child restraint system is not put under strain by the head restraint.
- ▶ Never place objects (e.g. cushions) under or behind the child restraint system.
- ▶ Set the front passenger seat as far back as possible and move the seat into the highest position if possible. Always make sure that the shoulder belt strap is correctly routed from the seat belt outlet of the vehicle to the shoulder belt guide on the child restraint system. The shoulder belt strap must be routed for-

wards from the seat belt outlet and, where possible, downwards to the child restraint system.

- ▶ Fully retract the seat cushion length adjustment.
- ▶ Adjust the seat cushion inclination such that the front edge of the seat cushion is in the highest position and the rear edge of the seat cushion is in the lowest position.
- ▶ Set the seat backrest to the most vertical position possible.

Activating/deactivating the child seat safety feature of the seat belt

⚠ WARNING Risk of injury or death if a seat belt is unfastened while the vehicle is in motion

If the seat belt is released while the vehicle is in motion, the special seat belt retractor is deactivated and the child restraint system is no longer correctly secured. The seat belt is

drawn in slightly by the inertia reel and cannot be immediately closed again.

- ▶ Stop the vehicle immediately in accordance with the traffic conditions.
- ▶ Activate the special seat belt retractor again and correctly secure the child restraint system.

When enabled, the child seat safety feature ensures that the seat belts of the front passenger seat and rear seats do not slacken once the child restraint system is secured.

The seat belts on the following seats are equipped with a child seat safety feature:

- Front passenger seat
- Rear seats

Installing a child restraint system

- ▶ When installing a child restraint system, always observe the manufacturer's installation and operating instructions as well as the information in this Operator's Manual.

- ▶ Pull the seat belt smoothly from the seat belt outlet.
- ▶ Engage the seat belt tongue in the seat belt buckle.

Activating the child seat safety feature:

- ▶ Pull the seat belt out fully and let the inertia reel retract it again. When the child seat safety feature is activated, you should hear a ratcheting sound.
- ▶ Push the child restraint system down until the seat belt sits tightly.

Deactivating the child seat safety feature:

- ▶ Press the release button of the seat belt buckle.
- ▶ Hold the seat belt tongue and guide it back to the seat belt outlet.

Installing an ISOFIX/LATCH child restraint system

- ▲ WARNING** Risk of accident if the rear bench seat, rear seat and seat backrest are not engaged

The rear bench seat, rear seat and seat backrest may fold forwards, even when you are driving.

- As a result, the vehicle occupant will be pushed into the seat belt with increased force. The seat belt will not be able to protect as intended and could cause additional injury.
 - Objects or loads in the trunk or cargo compartment will not be restrained by the seat backrest.
- ▶ Make sure that the rear bench seat, the rear seat and the seat backrest are engaged before every trip.

If the rear seat backrest is not engaged and locked in place, the red lock verification indicator will be visible.

- ▲ WARNING** Risk of injury or death if the permissible gross mass of the child and child restraint system together is exceeded.

Too much load may be placed on the LATCH-type (ISOFIX) or iSize child restraint systems and the child may not be restrained correctly in the event of an accident, for example.

- ▶ If the child is secured in a LATCH-type (ISOFIX) child restraint system with integrated seat belt, the total mass of the child and child restraint system must not exceed 73 lb (33 kg).

Always observe the information on the mass of the child:

- in the installation instructions and Operator's Manual of the manufacturer of the child restraint system used
- on a label on the child restraint system, if present

Regularly check that the permissible total mass of the child and child restraint system is still being adhered to.

When installing a child restraint system, also observe the following:

- ☑ Always observe the area of use and the suitability of the seats for attaching a child restraint system.

LATCH-type (ISOFIX) mounting brackets

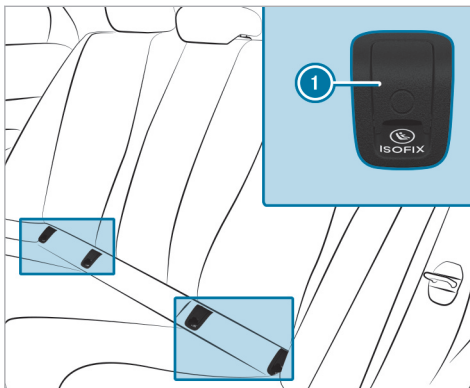

① ISOFIX mounting bracket

- ▶ Before every journey always ensure that the ISOFIX/LATCH child restraint system is correctly engaged in both mounting brackets on the vehicle.

! **NOTE** Damage to the seat belt for the center seat during installation of the child restraint system

- ▶ Make sure that the seat belt is not trapped.

- ▶ Remove and stow away the covers of the ISOFIX mounting brackets ① in the vehicle.
- ▶ Attach the ISOFIX/LATCH child restraint system to both mounting brackets ① in the vehicle.
- ▶ After removing the child seat, attach the covers of the ISOFIX mounting brackets ①.

Fastening a Top Tether

! **WARNING** Risk of injury or death if the rear seat backrests are not locked after Top Tether belts are installed

The rear seat backrests may fold forwards when you are driving.

As a result, child restraint systems will no longer be able to perform their intended protective function. This may also cause additional injuries.

- ▶ Always lock rear seat backrests after installing Top Tether belts.
- ▶ Observe the lock verification indicator.

If the rear seat backrest is not engaged and locked in place, the red lock verification indicator will be visible.



If the child restraint system is equipped with a Top Tether belt:

The risk of injury may be reduced by Top Tether. The Top Tether belt enables an additional connection between the child restraint system attached with ISOFIX (left and right rear seats) or the seat belt (all rear seats) and the vehicle.

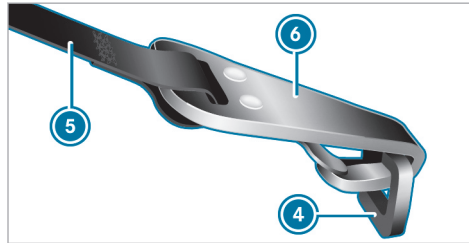
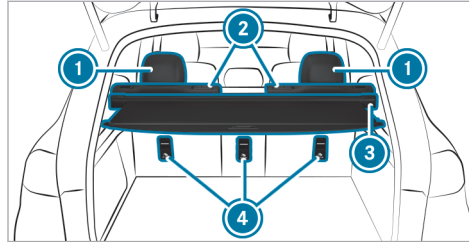

- ▶ If necessary, slide head restraint ① upwards (→ page 104).
- ▶ Install the ISOFIX/LATCH or belt-secured child restraint system with Top Tether. Comply with

the child restraint system manufacturer's installation instructions.

- ▶ Guide Top Tether belt ⑤ under head restraint ① between the two head restraint bars.
- ▶ If cargo compartment cover ③ is installed, guide Top Tether belt ⑤ downwards between cargo compartment cover ③ and seat backrest ②.
- ▶ Hook Top Tether hook ⑥ of Top Tether belt ⑤ into Top Tether anchorage ④ without twisting.
- ▶ Tension Top Tether belt ⑤. Comply with the child restraint system manufacturer's installation instructions.
- ▶ If necessary, slide head restraint ① downwards (→ page 104). Make sure that you do not interfere with the correct routing of Top Tether belt ⑤.

Fastening the child restraint system with the seat belt

⚠ WARNING Risk of accident if the rear bench seat, rear seat and seat backrest are not engaged

The rear bench seat, rear seat and seat backrest may fold forwards, even when you are driving.

- As a result, the vehicle occupant will be pushed into the seat belt with increased force. The seat belt will not be able to protect as intended and could cause additional injury.
- Objects or loads in the trunk or cargo compartment will not be restrained by the seat backrest.

▶ Make sure that the rear bench seat, the rear seat and the seat backrest are engaged before every trip.

If the rear seat backrest is not engaged and locked in place, the red lock verification indicator will be visible.

The seat belts on the following seats are equipped with a special seat belt retractor:

- Front passenger seat
- Rear seats

When enabled, the special seat belt retractor ensures that the seat belts of the front passenger seat and rear seats do not slacken once the child restraint system is secured.

- ▶ For a child restraint system of the category "Universal" or "Semi-Universal" ensure that this is approved for the vehicle seat.
- ▶ Install the child restraint system. The entire base of the child restraint system must always rest on the sitting surface of the seat.
- ▶ Always make sure that the shoulder belt strap is correctly routed from the seat belt outlet of the vehicle to the shoulder belt guide on the child restraint system. The shoulder belt strap must be routed forwards from the seat belt outlet and, where possible, downwards to the child restraint system.

▶ **Installation on the rear seat:** also secure Top Tether, if present.

▶ **Installation on the front passenger seat:** if necessary, adjust the seat belt outlet and the front passenger seat appropriately.

Child safety locks

Activating/deactivating the child safety lock for the rear doors

⚠ WARNING Risk of accident and injury if children are left unattended in the vehicle

If children are left unattended in the vehicle, they could in particular:

- open doors, thereby endangering other persons or road users.
- get out and be struck by oncoming traffic.
- operate vehicle equipment and become trapped, for example.

In addition, the children could also set the vehicle in motion, for example by:

- releasing the parking brake.
- changing gear.
- starting the vehicle.

- ▶ Never leave children unattended in the vehicle.
- ▶ When leaving the vehicle, always take the SmartKey with you and lock the vehicle.
- ▶ Keep the SmartKey out of the reach of children.

⚠ WARNING Risk of fatal injury due to exposure to extreme heat or cold in the vehicle

If persons, particularly children, are subjected to prolonged exposure to intense heat or cold, there is a risk of severe injury or even death.

- ▶ Never leave persons, particularly children, unattended in the vehicle.

⚠ WARNING Risk of accident and injury due to children left unattended in the vehicle

If children are traveling in the vehicle, they could, in particular:

- Open doors, thereby endangering other persons or road users.
 - Get out and be struck by oncoming traffic.
 - Operate vehicle equipment and become trapped, for example.
- ▶ Always activate the installed child safety locks if children are traveling in the vehicle.
 - ▶ Never leave children unattended in the vehicle.
 - ▶ When leaving the vehicle, always take the SmartKey with you and lock the vehicle.

There are child safety locks for the rear doors and the rear side windows. The child safety locks on the rear doors secure each door separately. The doors can no longer be opened from the inside.

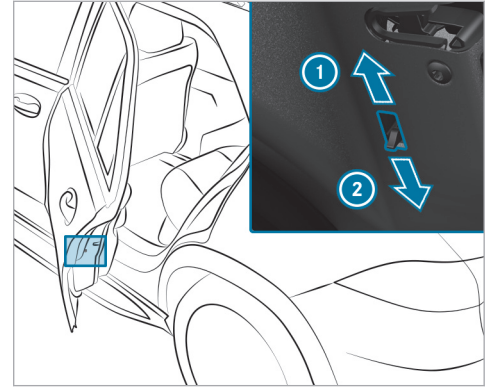

- ▶ Press the lever in direction ① (activate) or ② (deactivate).
- ▶ Check the functionality of the child safety lock.

Activating and deactivating the child safety lock for the rear side windows

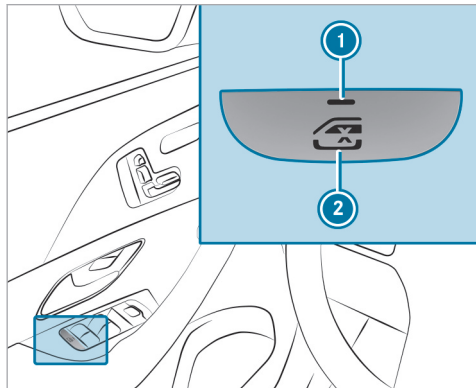

▶ **To activate/deactivate:** press the button ②.

The rear side window can be opened or closed as follows:

- The indicator lamp ① is lit: via the switch on the driver's door

- The indicator lamp ① is off: via the switch on the corresponding rear door or driver's door

Occupant presence reminder

Function of the occupant presence reminder

The occupant presence reminder can help to remind you about a child who may have been forgotten in the rear passenger compartment of the vehicle. It activates and deactivates automatically when the rear door is open for an extended period of time and a child, which the system presumes to be present, could enter or exit the vehicle.

When the vehicle is switched off, the **Do Not Leave People or Animals in the Vehicle** message appears on the driver display if the system was already automatically activated.

You can permanently deactivate the function in the multimedia system (→ page 72). When the system is deactivated, the  indicator lamp in the driver display lights up.

Activating or deactivating the occupant presence reminder in the multimedia system

Multimedia system:

→  ▶▶ Settings ▶▶ Vehicle

▶▶ Occupant Protection

▶ Activate or deactivate the function.

SmartKey

Overview of key functions

⚠ WARNING Risk of accident and injury due to children left unattended in the vehicle

If you leave children unattended in the vehicle, they could, in particular:

- open doors, thereby endangering other persons or road users.
- get out and be struck by oncoming traffic.
- operate vehicle equipment and become trapped, for example.

In addition, the children could also set the vehicle in motion by, for example:

- releasing the parking brake.
- changing the gearbox position.
- starting the vehicle.

▶ Never leave children unattended in the vehicle.

- ▶ When leaving the vehicle, always take the key with you and lock the vehicle.
- ▶ Keep the key out of reach of children.

! NOTE Damage to the SmartKey caused by magnetic fields

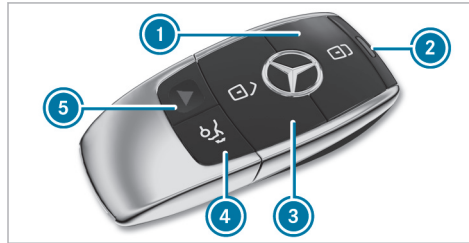

- ▶ Keep the SmartKey away from strong magnetic fields.



Vehicle key with panic alarm

- ① Locks the vehicle
- ② Indicator lamp
- ③ Unlocks the vehicle

- ④ Opens/closes the tailgate
- ⑤ Panic alarm

i If indicator lamp ② does not light up after pressing the  or  button, the battery is weak or possibly discharged. Replace the battery as soon as possible.

Replace the key battery (→ page 75).

The key locks and unlocks the following components:

- Doors
- Fuel filler flap
- Tailgate

If the vehicle is not opened within approximately 40 seconds after unlocking, it locks again. Anti-theft protection is activated again.

Do not keep the key together with electronic devices or metal objects. This can affect the key's functionality.

Do not keep the key in the temperature-controlled cup holder. Otherwise, the key will not be reliably detected.

Activating/deactivating the acoustic locking verification signal

Multimedia system:

→ [Home] >> Settings >> Vehicle

>> Open/Close

- ▶ Switch the **Acoustic Lock** on or off.

Activating/deactivating the panic alarm

Requirements

- The vehicle is switched off.



- ▶ **To activate:** press button ① for approximately one second.

A visual and audible alarm is triggered.

- ▶ **To deactivate:** briefly press button ① again.

or

- ▶ Press the start/stop button.
A key belonging to the vehicle must be detected in the vehicle.

Changing the unlocking settings

Possible unlocking functions of the SmartKey:

- Central unlocking
- Unlocking the driver's door and fuel filler flap

- ▶ **To switch between settings:** press the [Unlock] and [Lock] buttons simultaneously for approximately six seconds until the indicator lamp flashes twice.

Options when the unlocking function for the driver's door and fuel filler flap has been selected:

- **To unlock the vehicle centrally:** press the [Unlock] button twice.



- **Vehicles with KEYLESS-GO:** if you touch the inner surface of the door handle on the driver's door, only the driver's door and the fuel filler flap will be unlocked.

Deactivating the function of the key

Vehicles with KEYLESS-GO: if you deactivate the function of the SmartKey, the KEYLESS-GO functions will also be deactivated. Access or drive authorization by KEYLESS-GO will then no longer be possible with that particular SmartKey. Activate the function of the SmartKey so that all its functions will again be available.

You can also deactivate the function of the SmartKey to reduce the energy consumption of the SmartKey if you do not use the vehicle or a SmartKey for an extended period of time.

- ▶ Press and hold the [Lock] button on the SmartKey.

▶ With the key button  pressed, immediately press key button  twice in quick succession.

The indicator light of the key lights up once briefly and once for a long time.

❶ The following options for re-activating the SmartKey are available:

- Press any button on the SmartKey.
- Start the vehicle with the SmartKey in the marked space in the center console (→ page 157).

Removing/inserting the emergency key

Removing the emergency key

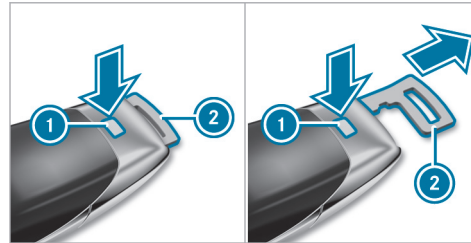

- ▶ Press the release knob ❶. The emergency key ❷ is pushed out slightly.
- ▶ Pull out the emergency key ❷ until it engages in the intermediate position.
- ❶ Depending on the vehicle's equipment, the intermediate position may not be available.
- ▶ Press the release knob ❶ again and fully remove the emergency key ❷.

Inserting the emergency key

- ▶ Press the release knob ❶.
- ▶ Insert the emergency key ❷ to the intermediate position, or fully until it engages.
- ❶ You can use the emergency key ❷ to attach the key to a key ring. Depending on the respective configuration, it is possible to engage the emergency key ❷ in the intermediate position.

Replacing the key battery

⚠ DANGER Risk of fatal injury due to swallowing batteries

Batteries contain toxic and corrosive substances. If batteries are swallowed or otherwise enter the body, severe internal burns can occur within two hours.

There is a risk of fatal injury!

- ▶ Keep the batteries out of the reach of children.

- ▶ If the lid and/or the battery compartment do not close securely, stop using the key and keep it away from children.
- ▶ If batteries are swallowed or otherwise enter the body, seek immediate medical attention.

 **ENVIRONMENTAL NOTE** Environmental damage due to improper disposal of batteries



Batteries contain pollutants. It is illegal to dispose of them with the household rubbish.



Dispose of batteries in an environmentally responsible manner. Take discharged batteries to a qualified specialist workshop or to a collection point for used batteries.

Requirements

- You require a CR 2032 3 V cell battery.

Mercedes-Benz recommends that you have the battery replaced at a qualified specialist workshop.

- ▶ Remove the mechanical key (→ page 75).

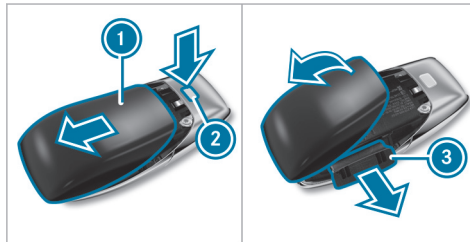

- ▶ Press release knob ② down fully and slide cover ① in the direction of the arrow.
- ▶ Fold out cover ① in the direction of the arrow and remove.
- ▶ Remove battery compartment ③ and take out the discharged battery.

- ▶ Insert the new battery into battery compartment ③. Observe the positive pole marking in the battery compartment and on the battery when doing this.
- ▶ Push in battery compartment ③.
- ▶ Re-attach cover ① and push it until it engages.

Problems with the key, troubleshooting

You can no longer lock or unlock the vehicle

Possible causes are:

- The key battery is weak or discharged.
- ▶ Check the battery using the indicator lamp (→ page 73).
- ▶ Replace the key battery, if necessary (→ page 75).
- ▶ Use the replacement key.
- ▶ Use the mechanical key to lock or unlock (→ page 80).
- ▶ Have key checked at a qualified specialist workshop.

There is interference from a powerful radio signal source

Possible causes if the function of the key is impaired:

- high voltage power lines
- mobile phones
- electronic devices (notebooks, tablets)
- shielding due to metal objects or induction loops for electrical gate systems or automatic barriers

▶ Make sure that there is sufficient distance between the key and the potential source of interference.

You have lost a key

- ▶ Have the key deactivated at a qualified specialist workshop.
- ▶ If necessary, have the mechanical lock replaced as well.

Doors

Unlocking/opening the doors from the inside

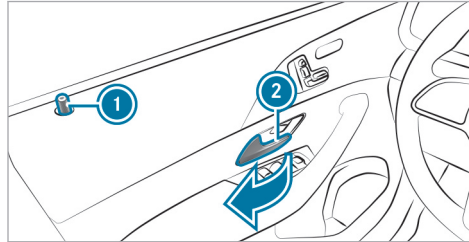

- ▶ **To unlock and open a front door:** pull door handle ②. Locking knob ① will pop up when the door is unlocked.
- ▶ **To unlock a rear door:** pull the rear door handle. The locking knob will pop up when the rear door is unlocked.
- ▶ **To open a rear door:** pull the rear door handle again.

Centrally locking and unlocking the vehicle from the inside

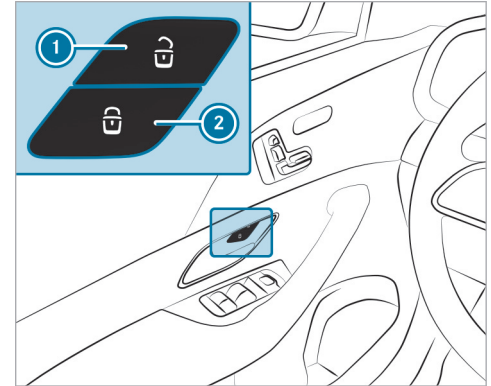

- ▶ **To unlock:** press the button ①.
- ▶ **To lock:** press the button ②.

This does not lock or unlock the fuel filler flap.

The vehicle is not unlocked when the button ① is pressed:

- If you have locked the vehicle using the key
- If you have locked the vehicle using KEYLESS-GO

Locking/unlocking the vehicle with KEYLESS-GO

Requirements

- The key is outside the vehicle.
- The distance between the key and the vehicle does not exceed 3 ft (1 m).
- The driver's door and the door on which the door handle is used are closed.

NOTE Vehicle damage due to unintentional opening of the tailgate

- When using an automatic car wash
- When using a high pressure cleaner

▶ Deactivate the function of the SmartKey in these situations.

or

▶ Make sure that the SmartKey is at a minimum distance of 10 ft (3 m) away from the vehicle.

Observe the notes:

- on washing the vehicle in a car wash (→ page 338)
- on using a high-pressure cleaner (→ page 340)

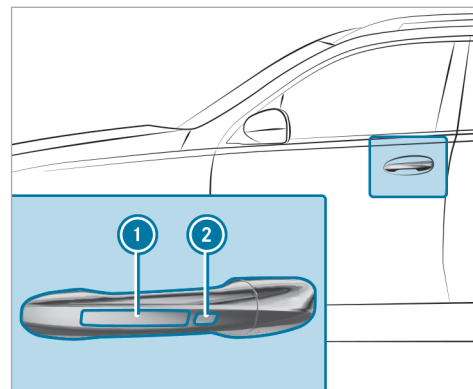

▶ **To unlock the vehicle:** touch the inner surface of the door handle.

▶ **To lock the vehicle:** touch sensor surface ① or ②.

▶ **Convenience closing:** touch recessed sensor surface ② until the closing process has been completed.

- ❗ Further information on convenience closing (→ page 89).

If you open the tailgate from outside, it is automatically unlocked.

Troubleshooting problems with KEYLESS-GO

You can no longer lock or unlock the vehicle using KEYLESS-GO

Possible causes:

- The function of the key has been deactivated.
- The key battery is weak or discharged.
- ▶ Activate the function of the key (→ page 74).
- ▶ Check the battery via the indicator lamp (→ page 73).
- ▶ If necessary, replace the key battery (→ page 75).
- ▶ Use the replacement key.
- ▶ Use the emergency key to lock or unlock (→ page 80).
- ▶ Have the vehicle and key checked at a qualified specialist workshop.

There is interference from a powerful radio signal source.

Possible causes if the function of KEYLESS-GO is impaired:

- high-voltage power lines
 - mobile phones
 - electronic devices (laptops, tablets)
 - shielding due to metallic objects or induction loops for electrical gate systems or automatic barriers
- ▶ Ensure that there is sufficient distance between the key and the potential source of interference.

Activating/deactivating the automatic locking feature

The vehicle will be locked automatically when the vehicle is switched on and the wheels are turning faster than walking pace.

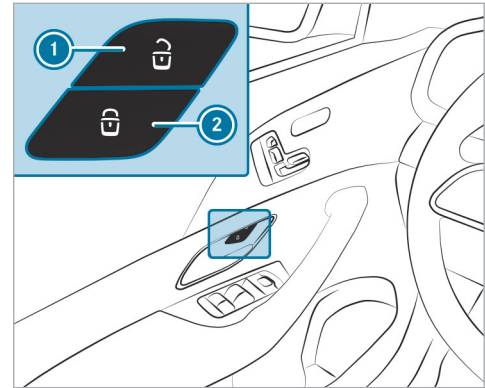

- ▶ **To activate:** press and hold button 2 for approximately five seconds until a tone sounds.
- ▶ **To deactivate:** press and hold button 1 for approximately five seconds until a tone sounds.

In the following situations, there is a danger of being locked out when the function is activated:

- while the vehicle is being tow started or pushed
- if the vehicle is being tested on a roller dynamometer

Activating/deactivating automatic locking in the MBUX multimedia system

Multimedia system:

→  **▶▶ Settings ▶▶ Vehicle**
▶▶ Open/Close

- ① The vehicle will be locked automatically when the vehicle is switched on and the wheels are turning faster than walking pace.

▶ Activate or deactivate **Automatic Door Lock**.

In the following situations, there is a danger of being locked out when the function is activated:

- The vehicle is being towed or pushed.
- If the vehicle is being tested on a roller dynamometer.

Power closing function

⚠ WARNING Risk of becoming trapped when the doors close automatically

Body parts or objects can become trapped, causing injuries.

- ▶ Ensure that no body parts or objects are in the closing area.
- ▶ Automatic closing of the doors can be canceled by pulling the outer or inner door handle.

If you push the door into the lock to the first detent position, the power closing function will automatically pull the door into the lock.

Locking/unlocking the driver's door with the mechanical key

- ① If you wish to lock the vehicle entirely using the mechanical key, first press the button for locking from the inside while the driver's door is open. Then proceed to lock the driver's door using the mechanical key.

- ① If you unlock and open the driver's door with the mechanical key, this triggers the anti-theft alarm system.
- ① If you unlock the driver's door with the mechanical key, the tailgate will not be unlocked.
- ① Information regarding starting the vehicle with the key in the storage compartment (emergency operation mode) (→ page 157).

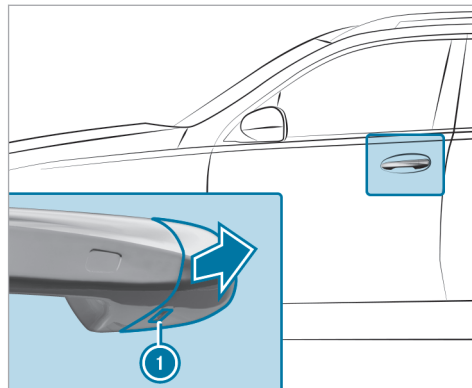

- ▶ Remove the mechanical key (→ page 75).
- ▶ Insert the mechanical key as far as it will go into the opening ① on the cover cap.
- ▶ Pull and hold the door handle.
- ▶ Pull the cover cap on the mechanical key as straight as possible away from the vehicle until it releases.
- ▶ Release the door handle.

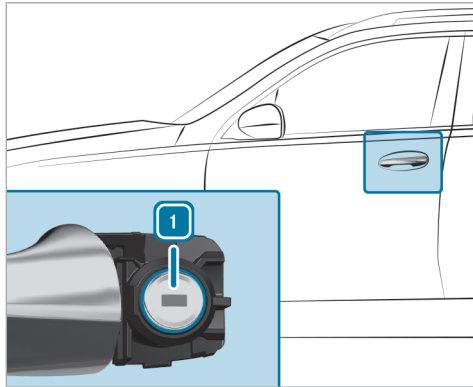

- ▶ **To unlock:** turn the mechanical key counter-clockwise to position ①.
- ▶ **To lock:** turn the mechanical key clockwise to position ①.
- ▶ Carefully press the cover cap onto the lock cylinder until it engages and is seated firmly.

Cargo compartment

Opening the tailgate

⚠ DANGER Risk of exhaust gas poisoning

Combustion engines emit poisonous exhaust gases such as carbon monoxide. Exhaust gases can enter the vehicle interior if the tailgate is open when the engine is running, especially if the vehicle is in motion.

- ▶ Always switch off the engine before opening the tailgate.
- ▶ Never drive with the tailgate open.

! **NOTE** Damage to the tailgate caused by obstacles above the vehicle

The tailgate swings rearwards and upwards when it is opened.

- ▶ Make sure that there is sufficient space behind and above the tailgate.

i Limiting the opening angle of the tailgate (→ page 86).

- ▶ If the tailgate is unlocked, pull the tailgate handle and release it again immediately.
- ▶ **Vehicles with HANDS-FREE ACCESS:** make a kicking movement with your foot below the bumper (→ page 84).

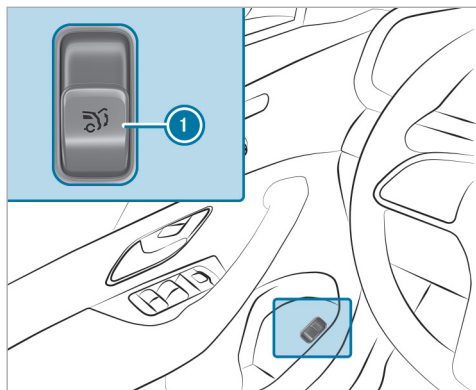

▶ Pull remote operating switch ❶ until the tailgate opens.

or

▶ Press and hold the  button on the key.
▶ If the tailgate has stopped in an intermediate position, pull it upwards. Release it as soon as it begins to open.

If an obstacle obstructs the tailgate during the automatic opening process, blockage detection will stop the tailgate. The automatic blockage detection function is only an aid. It is not a substitute for your attentiveness.

Closing the tailgate

⚠ WARNING Risk of injury from unsecured items in the vehicle

If objects, luggage or loads are not secured or not secured sufficiently, they could slip, tip over or be thrown around and thereby hit vehicle occupants.

There is a risk of injury, particularly in the event of sudden braking or a sudden change in direction.

- ▶ Always stow objects in such a way that they cannot be thrown around.
- ▶ Before the journey, secure objects, luggage or loads against slipping or tipping over.

Observe the notes on loading the vehicle.

Notes on closing the tailgate: your vehicle is equipped with automatic key recognition.

Note that the tailgate will not be locked in the following situation:

- You have locked the vehicle and closed the tailgate while a key belonging to the vehicle is inside the vehicle and is detected.
- and
- A second key belonging to the vehicle is not detected outside the vehicle.

Automatic key recognition is only an aid and is not a substitute for your attentiveness.

- ▶ Before locking, ensure that at least one key belonging to the vehicle is outside the vehicle.
- ▶ **To close the tailgate:** pull the tailgate downwards slightly. Release it as soon as it begins to close.

⚠ WARNING Risk of becoming trapped during automatic closing of the tailgate

Body parts may become trapped. There may be people in the closing area.

- ▶ Make sure that nobody is in the vicinity of the closing area during the closing process.

Use one of the following options to stop the closing process:

- Press the  button on the SmartKey.
- Press or pull the remote operating switch on the driver's door.
- Press the closing or locking button on the tailgate.
- Pull the tailgate handle.

Vehicles with HANDS-FREE ACCESS: it is also possible to stop the closing process by making a kicking movement below the rear bumper.

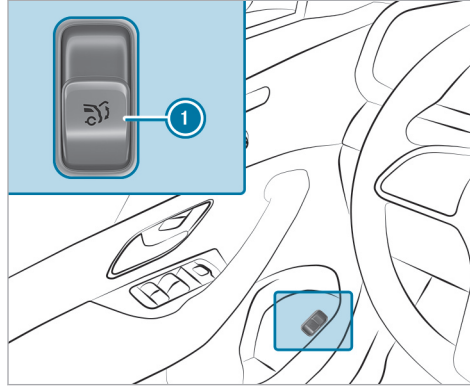

- ▶ Switch on the power supply or the vehicle.
- ▶ Push remote operating switch ① until the tailgate is fully closed.

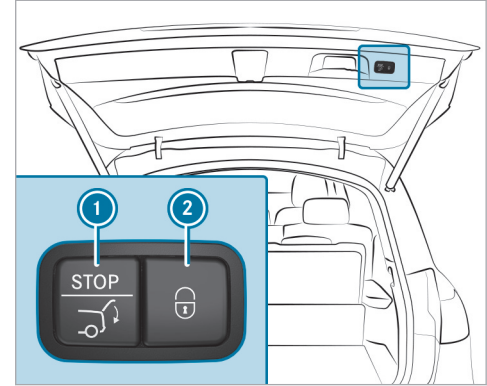

- ▶ Press closing button ① on the tailgate.

Vehicles with KEYLESS-GO

- ▶ Press locking button ② on the tailgate. If a key is detected outside the vehicle, the tailgate will close and the vehicle will be locked.
- ▶ Press and hold the  button on the key (with the key in the vicinity of the vehicle).

Vehicles with HANDS-FREE ACCESS

- ▶ Make a kicking movement with your foot below the bumper (→ page 84).

Automatic reversing function for the tailgate

The tailgate is equipped with automatic blockage detection with a reversing function. If an obstacle obstructs the tailgate during the automatic closing process, it will automatically open again slightly. Automatic blockage detection with the reversing function is only an aid and is not a substitute for your attentiveness.

- ▶ During the closing process, ensure that no body parts remain within the closing area.

⚠ WARNING Risk of becoming trapped despite reversing function

The reversing function will not react:

- To soft, light and thin objects, e.g. fingers
- Towards the end of the closing procedure

In these situations in particular, the reversing function cannot prevent someone being trapped.

- ▶ Ensure that no body parts are in the closing area.

If someone is trapped, either:

- Press the  button on the SmartKey.
- Press or pull the remote operating switch on the driver's door.
- Press the closing or locking button on the tailgate.
- Pull the tailgate handle.

HANDS-FREE ACCESS function

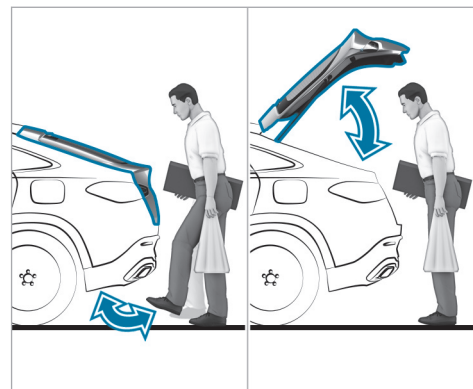

HANDS-FREE ACCESS allows you to open and close the tailgate, or even stop the opening and closing process at any point, by performing a kicking motion under the bumper. The transmission must be in position **P** for this function.

The kicking motion triggers the opening or closing process alternately.

- If you stop the tailgate opening process with a kicking motion, the tailgate is closed with the next kicking motion
- If you stop the tailgate closing process with a kicking motion, the tailgate is opened with the next kicking motion

In the following cases, the tailgate can be only closed with HANDS-FREE ACCESS:

- If the vehicle is switched on and the key's unlock function has been set so that only the driver's door is unlocked when activated (→ page 74).
- If the vehicle has been centrally locked from the inside (→ page 77).

Observe the notes when opening (→ page 81) and closing (→ page 82) the tailgate.

- ① Two warning tones sound when the tailgate is opening or closing.

⚠ WARNING Risk of burns caused by a hot exhaust system

The vehicle exhaust system can become very hot. If you use HANDS-FREE ACCESS, you could burn yourself by touching the exhaust system.

- ▶ Always ensure that you only make a kicking movement within the detection range of the sensors.

! NOTE Vehicle damage due to unintentional opening of the tailgate

- When using an automatic car wash
 - When using a high pressure cleaner
 - ▶ Deactivate the function of the SmartKey in these situations.
- or
- ▶ Make sure that the SmartKey is at a minimum distance of 10 ft (3 m) away from the vehicle.

Ensure that you are standing firmly on the ground when performing the kicking motion. You could otherwise lose your balance, e.g. on ice.

Observe the following notes:

- The key is behind the vehicle.
If the key is not recognized:
 - Take the key in your hand.
 - or
 - Ensure that the function of the key is activated (→ page 74).
- Stand at least 12 in (30 cm) away from the vehicle when performing the kicking motion.
- Do not come into contact with the bumper when performing the kicking motion.
- Do not carry out the kicking motion too slowly.
- The kicking motion must be towards the vehicle and back again.
- **Vehicles with trailer hitch:** Perform the kicking motion to the left or right of the ball head.

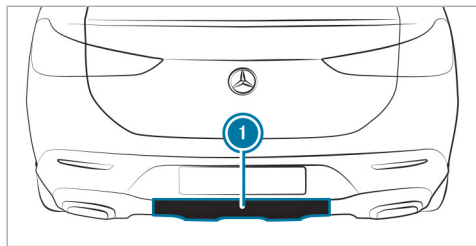

① Detection range of the sensors

If several consecutive kicking motions are not successful, wait ten seconds.

System limits

The system may be impaired or inoperative in the following cases:

- The sensors are dirty, e.g. due to road salt or snow.
- The kicking motion is performed with a prosthetic leg.

The tailgate can open or close unintentionally in the following situations:

- A person's arms or legs are moving in the sensor detection range, e.g. when polishing the vehicle or picking up objects.
- Objects are moved or placed behind the vehicle, e.g. the hose of a fuel dispenser, a charging cable or luggage.
- Tension belts, tarps or other covers are pulled over the bumper.
- A protective mat with a length reaching over the loading sill down into the detection range of the sensors is used.
- The protective mat is not secured correctly.
- **Vehicles with trailer hitch:** Work is being carried out on the trailer hitch, trailers or rear bicycle racks.

Deactivate the function of the key (→ page 74) or do not carry the key about your person in such situations.

Limiting the opening angle of the tailgate

Activating the opening angle limiter

You can limit the opening angle of the tailgate in the top half of its opening range up to a point shortly before the end position.

- ▶ Stop the opening procedure of the tailgate at the desired position.
- ▶ Press and hold the closing button on the tailgate until you hear a short tone. The opening angle limiter will be activated. The tailgate will then stop in the stored position when opened.

Fully opening the tailgate after it has stopped automatically

- ▶ Pull the handle on the outside of the tailgate again.

Deactivating the opening angle limiter

- ▶ Press and hold the closing button on the tailgate until two short tones sound.

Unlocking the tailgate with the emergency key

Requirements:

- The rear seat backrest has been folded forward.
- The collapsible cargo compartment cover has been removed.

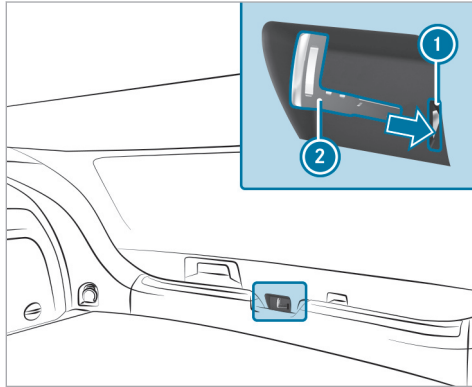

- ▶ Remove the emergency key (→ page 75).

- ▶ Insert emergency key ② into opening ① in the trim and push it in. The tailgate will be unlocked.

Side windows

Opening and closing the side windows

- ⚠ **WARNING** Risk of entrapment when opening a side window

When opening a side window, parts of the body could be drawn in or become trapped between the side window and window frame.

- ▶ When opening, make sure that nobody is touching the side window.
- ▶ If someone is trapped, release the button immediately or pull it in order to close the side window again.

- ⚠ **WARNING** Risk of becoming trapped when closing a side window

When closing a side window, body parts could be trapped in the closing area in the process.

- ▶ When closing, make sure that no body parts are in the closing area.
- ▶ If someone is trapped, release the button immediately or press the button in order to reopen the side window.

- ⚠ **WARNING** Risk of becoming trapped when children operate the side windows

Children could become trapped if they operate the side windows, particularly when unattended.

- ▶ Activate the child safety lock for the rear passenger compartment side windows.
- ▶ When leaving the vehicle, always take the SmartKey with you and lock the vehicle.
- ▶ Never leave children unattended in the vehicle.

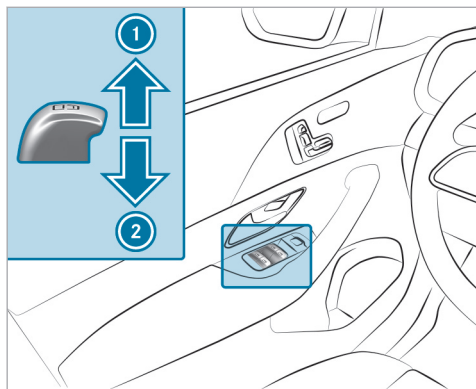

Requirements:

- The power supply or the vehicle has been switched on.



- ① Closing
- ② Opening

The buttons on the driver's door take precedence.

- ▶ **To start automatic operation:** press the  button beyond the pressure point or pull and release it.
- ▶ **To interrupt automatic operation:** press or pull the  button again.

When the vehicle is switched off, you can continue to operate the side windows.

This function is available for around four minutes or until a front door is opened.

Automatic reversing function of the side windows

If an obstacle impedes a side window during the closing process, the side window will open again automatically. The automatic reversing function is only an aid and is not a substitute for your attentiveness.

- ▶ During the closing process, make sure that no body parts are in the closing area.

⚠ WARNING Risk of becoming trapped despite there being reversing protection on the side window

The reversing function does not react:

- To soft, light and thin objects, e.g. fingers.
- During resetting.

The reversing function cannot prevent someone from becoming trapped in these situations.

- ▶ During the closing process, make sure that no body parts are in the closing area.
- ▶ If someone becomes trapped, press the  button to open the side window again.

Convenience opening (ventilating the vehicle before starting a journey)

⚠ WARNING Risk of entrapment when opening a side window

When opening a side window, parts of the body could be drawn in or become trapped between the side window and window frame.

- ▶ When opening, make sure that nobody is touching the side window.
- ▶ Release the button immediately if somebody becomes trapped.

Requirements

- The key is near the vehicle.

▶ Press and hold the  button on the key.

The following functions are performed:

- The vehicle is unlocked.
- The side windows are opened.
- The panoramic sliding sunroof is opened.
- The seat ventilation of the driver's seat is switched on.

ⓘ If the roller sunblind of the panoramic sliding sunroof is closed, the roller sunblind is opened first.

▶ **Interrupt convenience opening:** Release the button .

▶ **Continue convenience opening:** Press the button  again and hold pressed.

Convenience closing (closing the vehicle from outside)

⚠ WARNING Risk of entrapment due to not paying attention during convenience closing

When the convenience closing feature is operating, parts of the body could become trapped in the closing area of the side window and the sliding sunroof.

- ▶ When the convenience closing feature is operating, monitor the entire closing process and make sure that no body parts are in the closing area.

Requirements

- The key is near the vehicle.
- ▶ Press and hold the  button on the key.
- The following functions will be performed:
- The vehicle will be locked.
 - The side windows will be closed.

- The panoramic sliding sunroof will be closed.

▶ **To interrupt convenience closing:** release the button .

▶ **To continue convenience closing:** press and hold the  button again.

ⓘ Convenience closing also functions with KEY-LESS-GO (→ page 78).

Resolving problems with the side windows

⚠ WARNING Risk of becoming trapped or fatally injured if reversing protection is not activated

If you close a side window again immediately after it has been blocked, the side window will close with increased or maximum force. The reversing function is then not active and body parts may become trapped.

- ▶ Make sure that no parts of the body are in the closing area.

- ▶ To stop the closing process, release the button or press the button again to reopen the side window.

A side window cannot be closed and you cannot see the cause.

- ▶ Check to see whether any objects are in the window guide.
- ▶ Adjust the side windows.

Adjusting the side windows

If a side window is obstructed during closing and reopens again immediately:

- ▶ Immediately after this, pull and hold the corresponding button again until the side window has closed and hold the button for at least one more second (re-adjustment). The side window will be closed without the automatic reversing function.

If the side window is obstructed again and reopens again immediately:

- ▶ Immediately after this, pull and hold the corresponding button again until the side window

has closed and hold the button for at least one more second (follow-up adjustment). The side window will be closed without the automatic reversing function.

- ▶ If a side window is obstructed again during closing and reopens again slightly, consult a qualified specialist workshop.

The side windows cannot be opened or closed using the convenience opening feature.

Possible causes:

- The key battery is weak or discharged.
- ▶ Check the battery using the indicator lamp (→ page 73).
- ▶ Replace the key battery, if necessary (→ page 75).

Sliding sunroof

Opening and closing the sliding sunroof

- ▶ **i** The term "sliding sunroof" also refers to the panoramic sliding sunroof.

⚠ WARNING Risk of becoming trapped when the sliding sunroof is being opened and closed

Body parts may become trapped in the range of movement.

- ▶ During opening and closing, make sure that no body parts are in the range of movement.
- ▶ Release the button immediately if somebody becomes trapped.

or

- ▶ Briefly press the button in any direction during automatic operation. The opening or closing process will be stopped.

⚠ WARNING Risk of becoming trapped if the sliding sunroof is operated by children

Children operating the sliding sunroof could get caught in the moving parts, particularly if unattended.

- ▶ Never leave children unattended in the vehicle.
- ▶ When leaving the vehicle, always take the key with you and lock the vehicle.

⚠ WARNING Risk of becoming trapped when the roller sunblind is being opened and closed

Body parts may become trapped between the roller sunblind and frame or sliding roof.

- ▶ When opening or closing, make sure that no body parts are in the roller sunblind's range of movement.
- ▶ Release the button immediately if somebody becomes trapped.

or

- ▶ Briefly press the button in any direction during automatic operation.
The opening or closing process will be stopped.

! NOTE Malfunction due to snow and ice

Snow and ice may cause the sliding sunroof to malfunction.

- ▶ Open the sliding sunroof only if it is free of snow and ice.

! NOTE Damage caused by moisture ingress

- ▶ Do not open the sliding sunroof if it has just rained.
- ▶ Do not open the sliding sunroof immediately after washing the vehicle in a car wash.

! NOTE Damage caused by protruding objects

Objects that protrude from the sliding sunroof may damage the seals.

- ▶ Do not allow anything to protrude from the sliding sunroof.

! NOTE Damage to the panorama roof with power tilt/sliding panel due to non-approved roof luggage racks

The panorama roof with power tilt/sliding panel may be damaged by the roof luggage rack if you attempt to open it when using a roof luggage rack not tested and approved for Mercedes-Benz.

- ▶ When a roof luggage rack is installed, open the panorama roof with power tilt/sliding panel only if this has been tested and approved for Mercedes-Benz.

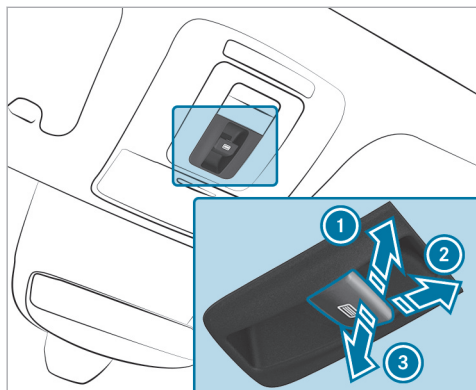

The panorama roof with power tilt/sliding panel may be raised to allow ventilation of the vehicle interior.



- ➊ To raise
- ➋ To open
- ➌ To close/lower

Use the  button to operate the panoramic sliding sunroof and the roller sunblind.

The panoramic sliding sunroof can be operated only when the roller sunblind is open. **Exception:** ventilating the vehicle interior

- ▶ Check whether the sliding sunroof can be raised or opened when a roof luggage rack is installed.
- ▶ **To start automatic operation:** press the  button beyond the point of resistance or pull and release it.
- ▶ **To interrupt automatic operation:** briefly press the  button in any direction. The opening/closing process will be stopped.

Vehicles with a panoramic sliding sunroof: the automatic raising feature is available only when the sliding sunroof is closed or raised.

- ▶ **To ventilate the vehicle interior:** raise the sliding sunroof. The roller sunblind will open slightly.

Automatic reversing function of the sliding sunroof

If an obstacle obstructs the sliding sunroof during the closing process, the sliding sunroof will open again automatically. The automatic reversing function serves solely as an aid and is not a substitute for your attentiveness.

- ▶ Keep the opening area and the guide rails free of deposits, e.g. ice, snow or leaves.
- ▶ When closing the sliding sunroof, make sure that no body parts or objects are in the closing area.

⚠ WARNING Risk of becoming trapped despite the reversing function being active

In particular, the reversing function does not react:

- To soft, light and thin objects, e.g. fingers.
- Towards the end of the closing procedure.
- During resetting.

- ▶ During the closing process, make sure that no body parts are in the closing area.
- ▶ Release the button immediately if somebody becomes trapped.

or

- ▶ Briefly press the button in any direction during automatic operation. The closing process will be stopped.

Automatic reversing function of the roller sunblind

If an obstacle obstructs the roller sunblind during the closing process, the roller sunblind will open again automatically. The automatic reversing function serves solely as an aid and is not a substitute for your attentiveness.

- ▶ Keep the opening area and the guide rails free of deposits, e.g. ice, snow or leaves.
- ▶ When closing the roller sunblind, make sure that no body parts or objects are in the area of movement.

⚠ WARNING Risk of becoming trapped despite reversing function

In particular, the reversing function does not react to soft, light and thin objects, e.g. fingers.

- ▶ When closing the roller sunblind, make sure that no body parts are in the range of movement.
- ▶ Release the button immediately if somebody becomes trapped.

or

- ▶ Briefly press the button in any direction during the automatic closing process. The closing process will be stopped.

Automatic functions of the sliding sunroof

- ① The term "sliding sunroof" also refers to the panoramic sliding sunroof.

Rain closing function when driving

Vehicles with a panoramic sliding sunroof: if it starts to rain, the raised sliding sunroof will automatically be lowered while the vehicle is in motion.

Automatic lowering function

Vehicles with a panoramic sliding sunroof: if the sliding sunroof is raised at the rear, it will automatically be lowered slightly at higher speeds. At low speeds, it will be raised again automatically.

⚠ WARNING Risk of becoming trapped by automatic lowering of the sliding sunroof

At higher speeds, the raised sliding sunroof will automatically be lowered slightly at the rear.

- ▶ Make sure that nobody reaches into the sliding sunroof's range of movement while the vehicle is in motion.
- ▶ If somebody becomes trapped, briefly push the sliding sunroof button forwards or backwards.

- ① By pushing or pulling the  button, you can interrupt the automatic functions "Rain closing function when driving" and "Automatic lowering".

Rectifying problems with the sliding sunroof

▲ WARNING Risk of becoming trapped or fatal injuries when the sliding sunroof is closed again

If the sliding sunroof is closed again immediately after it has been blocked or reset, it will close with increased force.

- ▶ Make sure that no parts of the body are in the closing area.
- ▶ Release the button immediately if somebody becomes trapped.

or

- ▶ Briefly press the button in any direction during the automatic closing process. The closing process will be stopped.

The sliding sunroof cannot be closed and you cannot see the cause.

- ① The term "sliding sunroof" also refers to the panorama roof with power tilt/sliding panel.

If the sliding sunroof is obstructed during closing and reopens again slightly:

- ▶ Immediately after automatic reversing, pull and hold the  button down again to the point of resistance until the sliding sunroof is closed. The sliding sunroof will be closed with increased force.



If the sliding sunroof is obstructed again and opens again slightly:

- ▶ Repeat the previous step. The sliding sunroof will be closed again with increased force.

Vehicles with a panorama roof with power tilt/sliding panel: The sliding sunroof or the roller sunblind is not operating smoothly.

- ▶ Reset the sliding sunroof and the roller sunblind.

Resetting the sliding sunroof and the roller sunblind

- ▶ Pull and hold the  button little by little until the sliding sunroof is fully closed.
- ▶ Pull and hold the  button little by little until the roller sunblind is fully closed.

- ▶ Use automatic operation to fully open and then close the sliding sunroof.

Anti-theft protection

Function of the immobilizer

The immobilizer prevents your vehicle from being started without the correct key.

The immobilizer is automatically activated when the vehicle is switched off, and deactivated when the vehicle is switched on.

When leaving the vehicle, always take the key with you and lock the vehicle. Anyone can start the vehicle if a valid key has been left inside the vehicle.

- ① In the event that the engine cannot be started (although the vehicle's starter battery is charged), the immobilizer may be defective. Contact an authorized Mercedes-Benz Center or call 1-800-FOR-MERCEdes (in the USA) or 1-800-387-0100 (in Canada).

ATA (anti-theft alarm system)

Function of the ATA system

If the ATA system is armed, a visual and audible alarm will be triggered in the following situations:

- When a door is opened
- When the tailgate is opened
- When the hood is opened
- When the interior protection is triggered (→ page 96)
- When the tow-away alarm is triggered (→ page 95)

The ATA system will be armed automatically after approximately ten seconds in the following situations:

- After you lock the vehicle with the key
- After you lock the vehicle using KEYLESS-GO

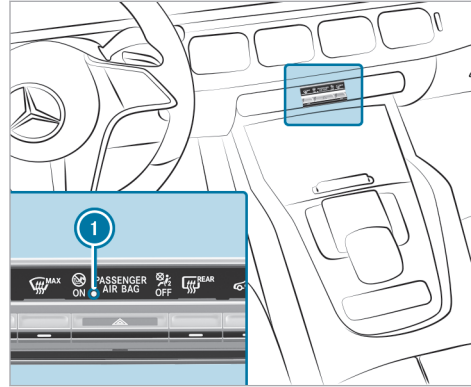

Indicator lamp **i** will flash when the ATA system is armed.

The ATA system will be disarmed automatically in the following situations:

- After you unlock the vehicle with the key
- After you unlock the vehicle using KEYLESS-GO

- After you press the Start/Stop button with the key in the marked space (→ page 157)

i If the battery is heavily discharged, the Anti-Theft Alarm system is automatically deactivated to facilitate the next engine start.

Deactivating the ATA

▶ Press the ,  or  button on the key.

or

▶ Press the start/stop button with the key in the stowage compartment (→ page 157)

Deactivating the alarm using KEYLESS-GO

▶ Grasp the outside door handle with the key outside the vehicle.

Function of tow-away alarm

i This function may not be available in all countries.

A visual and audible alarm will be triggered if an alteration to your vehicle's angle of inclination is detected while the tow-away alarm is armed.



The tow-away alarm will be armed automatically after about 60 seconds:

- After you lock the vehicle with the key
- After you lock the vehicle using KEYLESS-GO

The tow-away alarm will be armed only when the following components are closed:

- Doors
- Tailgate

The tow-away alarm will automatically be deactivated:

- After you press the  or  button on the key
- After you press the start/stop button with the key in the marked space (→ page 157)
- After you unlock the vehicle using KEYLESS-GO
- When using HANDS-FREE ACCESS

Information on collision detection on a parked vehicle (→ page 188).

Arming/deactivating tow-away alarm

Multimedia system:

  **» Settings** **» Vehicle**
» Opening/closing **» Vehicle Protection**

 Arm or deactivate **Tow-away Protection**.

Tow-away alarm is armed again in the following cases:

- The vehicle is unlocked again.
- A door is opened.
- The vehicle is locked again.

Function of interior protection

 This function may not be available in all countries.

When interior protection is armed, a visual and audible alarm is triggered if movement is detected in the vehicle interior.

Interior protection is armed automatically after approximately ten seconds:



- after locking the vehicle with the key

- after locking the vehicle using KEYLESS-GO

Interior protection is armed only when the following components are closed:

- Doors
- Tailgate

Interior protection is automatically deactivated:

- after pressing the  or  button on the key
- after pressing the start/stop button with the key in the stowage compartment (→ page 157)
- after unlocking the vehicle using KEYLESS-GO
- when using HANDS-FREE ACCESS

The following situations can lead to a false alarm:

- when there are moving objects such as mascots in the vehicle interior
- if a side window is open
- if the panorama roof with power tilt/sliding panel is open

Arming/disarming interior protection

Multimedia system:

↳  » Settings » Vehicle
» Opening/closing » Vehicle Protection

▶ Activate or deactivate **Interior Protection**.

Interior protection will be armed again in the following cases:

- The vehicle is unlocked again.
- A door is opened.
- The vehicle is locked again.

Notes on the correct driver's seat position

⚠ WARNING Risk of accident due to adjusting the vehicle settings while the vehicle is in motion

You could lose control of the vehicle in the following situations in particular:

- if you adjust the driver's seat, head restraints, steering wheel or the mirror while the vehicle is in motion.
- if you fasten your seat belt while the vehicle is in motion.

► Before starting the vehicle: adjust in particular the driver's seat, head restraints, steering wheel and mirror, and fasten your seat belt.

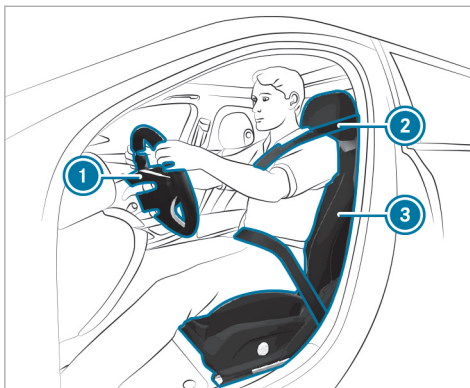

Ensure the following when adjusting steering wheel ①, seat belt ② and driver's seat ③:

- You are sitting as far away from the driver's air bag as possible, taking the following points into consideration:
- You are sitting in an upright position
- Your thighs are slightly supported by the seat cushion

- Your legs are not fully extended and you can depress the pedals properly
- The back of your head is supported at eye level by the center of the head restraint
- You can hold the steering wheel with your arms slightly bent
- You can move your legs freely
- You can see all the displays on the instrument cluster clearly
- You have a good overview of the traffic conditions
- Your seat belt sits snugly against your body and passes across the center of your shoulder and across your hips in the pelvic area

Notes on grab handles

⚠ WARNING Risk of injury due to excessive load on the grab handles

If you apply your full body weight to the grab handle or pull it abruptly, the grab handle may

be damaged or come loose from its anchorage. This may result in injuries.

- ▶ Use the grab handles only to stabilize the seating position or to assist in getting in and out of the seat.

Seats

Adjusting the front seat

▲ WARNING Risk of becoming trapped if the seats are adjusted by children

Children could become trapped if they adjust the seats, particularly when unattended.

- ▶ When leaving the vehicle, always take the SmartKey with you and lock the vehicle.
- ▶ Never leave children unattended in the vehicle.

You can adjust the seats when the vehicle is switched off.

▲ WARNING Risk of becoming trapped if the seats are adjusted

When adjusting a seat, you may trap yourself or a vehicle occupant, e.g. on the seat guide rail.

- ▶ Make sure that no part of the body is within the seat's range of motion when adjusting a seat.

Observe the safety notes on "Air bags" and "Children in the vehicle".

▲ WARNING Risk of accident due to adjusting the vehicle settings while the vehicle is in motion

You could lose control of the vehicle in the following situations in particular:

- If you adjust the driver's seat, the head restraint, the steering wheel or the mirror while the vehicle is in motion
- If you fasten your seat belt while the vehicle is in motion

- ▶ Before starting the vehicle: in particular, adjust the driver's seat, head restraint, steering wheel and mirror, and fasten your seat belt.

▲ WARNING Risk of becoming trapped if the seat height is adjusted carelessly

If you adjust the seat height carelessly, you or other vehicle occupants could be trapped and thereby injured.

Children in particular could accidentally press the electrical seat adjustment buttons and become trapped.

- ▶ While moving the seats, make sure that hands or other body parts do not get under the lever assembly of the seat adjustment system.

▲ WARNING Risk of injury due to head restraints not being installed or being adjusted incorrectly

If head restraints have not been installed or have not been adjusted correctly, there is an increased risk of injury in the head and neck area, e.g. in the event of an accident or when braking.

- ▶ Always drive with the head restraints installed.
- ▶ Before driving off, make sure for every vehicle occupant that the center of the head restraint supports the back of the head at about eye level.

Do not interchange the head restraints of the front and rear seats. Otherwise, you will not be able to adjust the height and angle of the head restraints correctly.

Adjust the head restraint fore-and-aft position so that it is as close as possible to the back of your head.

▲ WARNING Risk of injury or death due to an incorrect seat position

The seat belt does not offer the intended level of protection if you have not moved the seat backrest to an almost vertical position.

In particular, you could slip beneath the seat-belt and become injured.

- ▶ Adjust the seat properly before beginning your journey.
- ▶ Always ensure that the seat backrest is in an almost vertical position and that the shoulder belt is routed across the center of your shoulder.

▲ WARNING Risk of potentially fatal injuries due to objects trapped under the front passenger seat

Objects trapped under the front passenger seat may interfere with the function of the automatic front passenger air bag shutoff or damage the system.

- ▶ Do not stow any objects under the front passenger seat.
- ▶ When the front passenger seat is occupied, ensure that no objects have become trapped beneath the front passenger seat.

! NOTE Damage to the seats when adjusting

The seats may be damaged by objects when adjusting the seats.

- ▶ When adjusting the seats, make sure that there are no objects in the footwell, under or behind the seats.

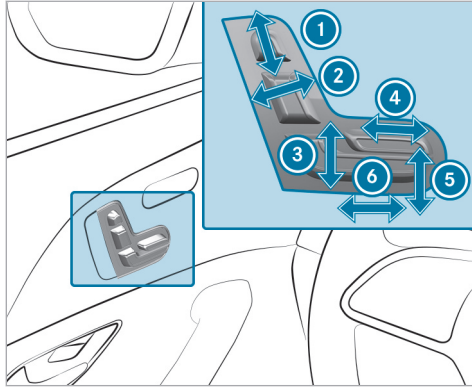

- ① Head restraint height
- ② Seat backrest inclination
- ③ Seat height
- ④ Seat cushion length
- ⑤ Seat cushion inclination
- ⑥ Seat fore-and-aft position

▶ Save the settings with the memory function (→ page 113).

Adjusting the front passenger seat electrically from the driver's seat

⚠ WARNING Risk of injury or death due to the front seat being positioned too close to the cockpit

The front airbags can also injure the occupants in the front of the vehicle.

- ▶ Always adjust the front seats so they are as far away as possible from the front airbags.
- ▶ In addition, observe the notes on correct seat adjustment.

Requirements:

- The power supply is switched on.

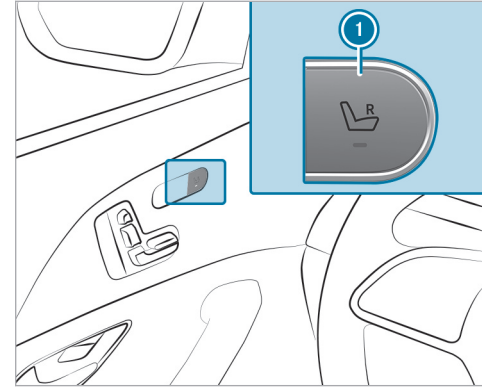

You can call up the following functions for the front passenger seat:

- Seat adjustment
- Seat heating
- Seat ventilation
- Memory function

- ▶ **To select the front passenger seat:** press button ❶.
When the indicator lamp lights up, the front passenger seat is selected.
- ▶ Adjust the front passenger seat using the buttons on the driver's side door operating unit.
- ▶ **To select the driver's seat:** press button ❶ again.
When the indicator lamp goes out, the driver's seat has been selected.

Adjusting the 4-way lumbar support

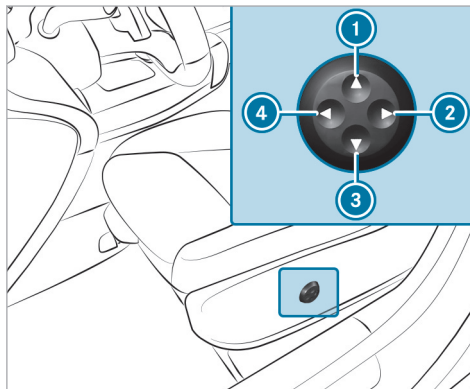

- ❶ Higher
- ❷ Softer
- ❸ Lower
- ❹ Firmer

- ▶ Use buttons ❶ to ❹ adjust the contour of the backrest.

Head restraints

Adjusting the front seat head restraints manually

⚠ WARNING Risk of accident due to adjusting the vehicle settings while the vehicle is in motion

You could lose control of the vehicle in the following situations in particular:

- if you adjust the driver's seat, head restraints, steering wheel or the mirror while the vehicle is in motion.
- if you fasten your seat belt while the vehicle is in motion.

- ▶ Before starting the vehicle: adjust in particular the driver's seat, head restraints, steering wheel and mirror, and fasten your seat belt.

▲ WARNING Risk of injury due to head restraints not being installed or being adjusted incorrectly

If head restraints have not been installed or have not been adjusted correctly, there is an increased risk of injury in the head and neck area, e.g. in the event of an accident or when braking.

- ▶ Always drive with the head restraints installed.
- ▶ Before driving off, make sure for every vehicle occupant that the center of the head restraint supports the back of the head at about eye level.

Do not rotate the head restraints of the front and rear seats. Otherwise, you will not be able to adjust the height and angle of the head restraints correctly.

Adjust the head restraint fore-and-aft position so that it is as close as possible to the back of your head.

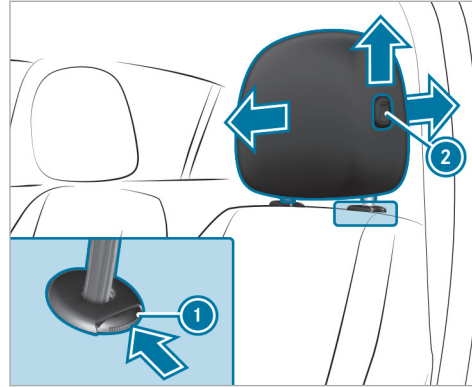

- ▶ **To raise:** pull the head restraint up.
- ▶ **To lower:** press release knob ① in the direction of the arrow and push the head restraint down.
- ▶ **To move forward:** press release knob ② and pull the head restraint forward.
- ▶ **To move backwards:** press release knob ② and push the head restraint backwards.

■ Adjusting the front seat luxury head restraints manually

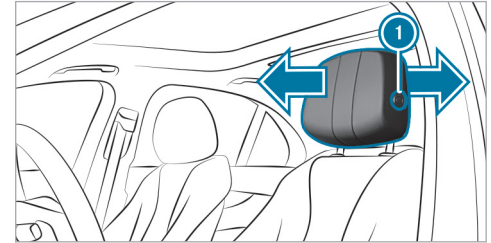

- ▶ **To move forward:** press release knob ① and pull the head restraint forward.
- ▶ **To move backwards:** press release knob ① and push the head restraint backwards.

Adjusting the head restraints of the rear seats manually

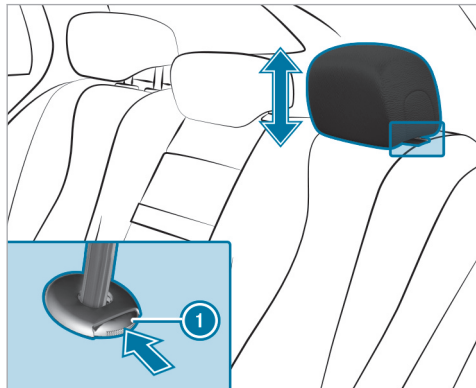

- ▶ **To raise:** pull the head restraint up.
- ▶ **To lower:** press release knob ① in the direction of the arrow and push the head restraint down.

Installing/removing the rear seat head restraints

Removing

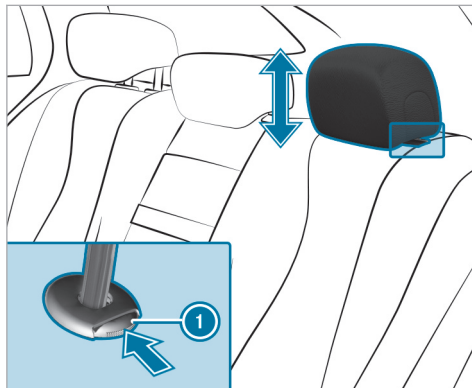

- ▶ Release the rear seat backrest and fold it forwards slightly (→ page 117).
- ▶ Pull the head restraint upwards as far as it will go.

- ▶ Push release knob ① in the direction of the arrow and pull out the head restraint.

Installing

- ▶ Insert the head restraint such that the notches on the bar are on the left when viewed in the direction of travel.
- ▶ Push the head restraint down until it engages.
- ▶ Fold the rear seat backrest back until it engages.

Configuring the seat settings

Multimedia system:

→ ▶▶ Comfort ▶▶ Seat

Adjusting the air cushions

- ▶ On the corresponding menu, adjust the air cushions for [Lumbar](#) or [Side Bolsters](#).

Setting the seat heating balance

- ▶ Select [Heating Settings](#).
- ▶ Select [Seat Heating Balance](#).

- ▶ Adjust the heat distribution for the desired seat.

Setting automatic seat adjustment

⚠ WARNING Risk of becoming trapped during adjustment of the driver's seat after calling up a driver profile

Selecting a user profile may trigger an adjustment of the driver's seat to the position saved under the user profile. You or other vehicle occupants could be injured in the process.

- ▶ Make sure that when the position of driver's seat is being adjusted using the multimedia system, no people or body parts are in the seat's range of movement.

If there is a risk of someone becoming trapped, immediately stop the adjustment process by:

- ▶ a) Pressing the warning message on the central display.

or

- ▶ b) Pressing a position button of the memory function or a seat adjustment switch in the driver's door. The adjustment process is stopped.

Multimedia system:

-  ▶ Comfort ▶ Seat
- ▶▶ Automatic Seat Positioning

Manually adjusting driver's seat and steering wheel position to body size

The vehicle will calculate suitable driver's seat and steering wheel positions on the basis of the driver's body size and set this directly.

- ▶ **To set the unit of measurement:** select **cm** or **ft/in.**
- ▶ Set the size using the scale.
- ▶ Select **Start Positioning.** The driver's seat and steering wheel positions will be adjusted to the body size that has been set.

- ⓘ You can also configure these settings via the Mercedes me user account for your user profile. By synchronizing the profiles in the vehi-

cle and the Mercedes me connect profiles, you can carry over these settings for your vehicle.

- ⓘ If the driver's seat and steering wheel positions calculated by the vehicle are not practical or comfortable, they can be manually adapted at any time via the control buttons. The outside mirrors are not set via this function. Instead, they have to be set manually via the operating switches.

Overview of massage programs

- ⓘ The availability of the massage function for the various seats is dependent on the vehicle equipment.
- **Hot Relaxing Back** Combination of heat and massage. It starts by massaging the back. In addition, you will start to notice warm pressure points, beginning in the pelvic area.
- **Hot Relaxing Shoulder** Combination of heat and massage. It starts by massaging the shoulders. In addition, you will start to notice



warm pressure points, beginning in the pelvic area.

- **Activating Massage** Activating massage with upward-moving massage waves.
- **Classic Massage** Relaxing back massage.
- **Wave Massage** Regenerating massage program via massage waves across the back and in the seat cushion.
- **Mobilizing Massage** Mobilizing Massage with upward-moving massage waves. Can promote deeper respiration and hence improve circulation and blood pressure.
- **Active Workout, Backrest and Active Workout, Cushion** These programs require your cooperation. Alternating between tensing and releasing helps to improve blood flow to your muscles. Press against a pressure point as soon as you feel it.

Selecting the massage program for the front seats

Multimedia system:

➔  ➔ **Comfort**

- ▶ Select **Massage**.
- ▶ Select a massage program (→ page 105).
- ▶ Start the program for the desired seat .
- ▶ **To set the massage intensity:** switch **Intensive** on or off .
- ▶ **To stop the massage:** select .

 The availability of this function is dependent on the vehicle's equipment.

Resetting seat settings

Multimedia system:

➔  ➔ **Comfort** ➔ **Seat**

- ▶ Select **Reset**.
- ▶ Select  for the desired seat.
The settings for the selected seat will be reset.

Switching the seat heating on/off

 **WARNING** Risk of burns due to repeatedly switching on the seat heating

Repeatedly switching on the seat heating can cause the seat cushion and seat backrest padding to become very hot.

In particular, the health of persons with limited temperature sensitivity or a limited ability to react to high temperatures may be affected or they may even suffer burn-like injuries.

▶ Do not repeatedly switch on the seat heating.

To protect against overheating, the seat heating may be temporarily deactivated after it has been switched on repeatedly.

 **NOTE** Damage to the seats caused by objects or documents when the seat heating is switched on

When the seat heating is switched on, overheating may occur due to objects or docu-

ments placed on the seats, e.g. seat cushions or child seats. This could cause damage to the seat surface.

- ▶ Make sure that no objects or documents are on the seats when the seat heating is switched on.

Requirements

- The power supply is switched on.

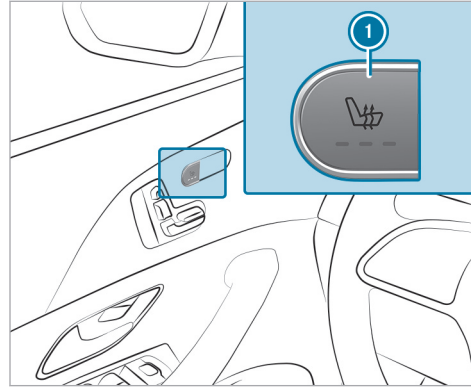

Seat heating in the cockpit

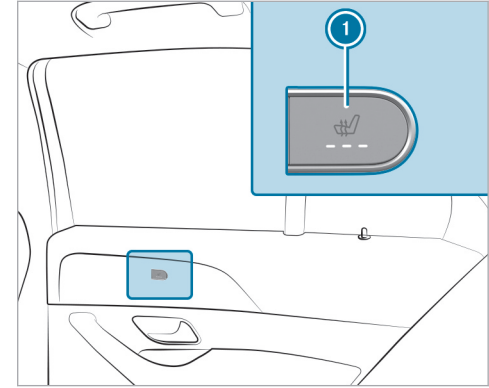

Seat heating in the rear passenger compartment

- ▶ Press button ❶ repeatedly until the desired heating level is set. Depending on the heating level, up to three indicator lamps will light up. If all indicator lamps are off, the seat heating is switched off.

- ① The seat heating will automatically switch down from the three heating levels after 8, 10 and 20 minutes until the seat heating is switched off.

Switching the seat ventilation on/off

Requirements:

- The power supply is switched on.

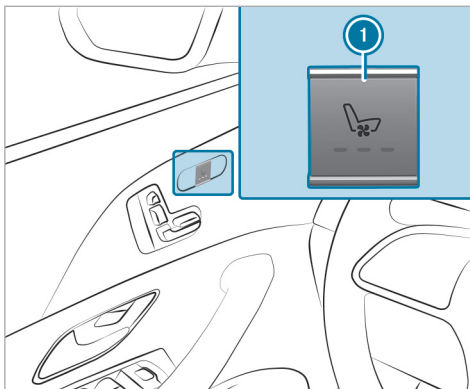

Seat ventilation in the cockpit

- ▶ Press button ① repeatedly until the desired ventilation level is set. Depending on the ventilation level, up to three indicator lamps will light up. If all indicator lamps are off, the seat ventilation is switched off.

Steering wheel

Adjusting the steering wheel manually

- ▲ **WARNING** Risk of accident due to adjusting the vehicle settings while the vehicle is in motion

You could lose control of the vehicle in the following situations in particular:

- If you adjust the driver's seat, the head restraint, the steering wheel or the mirror while the vehicle is in motion
- If you fasten your seat belt while the vehicle is in motion

- ▶ Before starting the vehicle: in particular, adjust the driver's seat, head restraint, steering wheel and mirror, and fasten your seat belt.

- ▲ **WARNING** Risk of entrapment for children when adjusting the steering wheel

Children could injure themselves if they adjust the steering wheel.

- ▶ Never leave children unattended in the vehicle.
- ▶ When leaving the vehicle, always take the key with you and lock the vehicle.

Unlocking

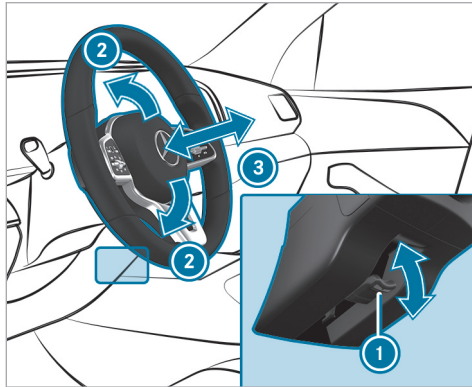

- ▶ Fold release lever ① down as far as it will go.

- ▶ Adjust height ② and distance ③ to the steering wheel.

Locking

- ▶ Fold release lever ① up as far as it will go.
- ▶ Check and make sure that the steering column is locked by moving the steering wheel.

Adjusting the steering wheel electrically

The steering wheel can be adjusted when the vehicle is switched off.

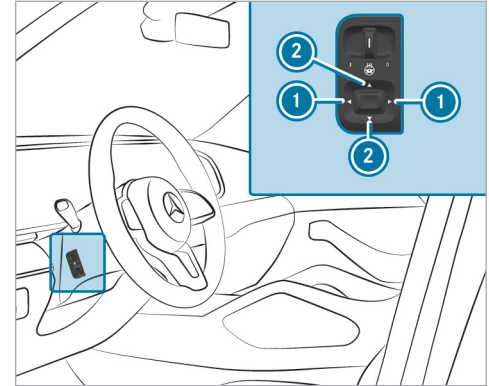

- ① To adjust the distance to the steering wheel
- ② To adjust the height
- ▶ Save the settings with the memory function (→ page 113).

Switching the steering wheel heater on/off

Depending on the vehicle version, the steering wheel heater can be switched on and off using a switch on the steering wheel.

Requirements

- The vehicle is switched on.

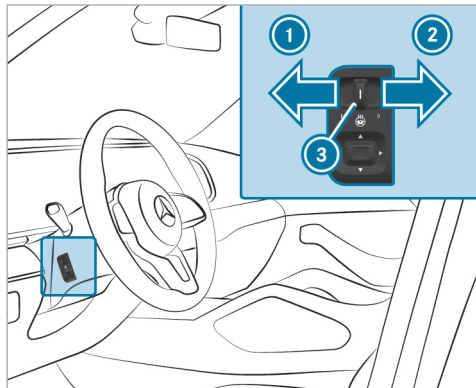

▶ **To switch on:** push the switch into position

- 1.
- Indicator lamp 3 lights up.

▶ **To switch off:** push the switch into position

- 2.
- Indicator lamp 3 will go out.

When you switch the ignition off, the steering wheel heater will switch off.

Decoupling the steering wheel heater from the seat heating

Requirements:

- The power supply or the vehicle has been switched on.
- The steering wheel heater and the seat heating are linked.

Multimedia system:

➔  ➔ **Comfort** ➔ **Seat**
➔ **Heating Settings**

The function is active by default and the steering wheel heater will automatically be activated and

deactivated when the seat heating is switched on and off.

▶ Tap on **Additional Steering Wheel Heating**. The steering wheel heater will be decoupled from the seat heating.

- i** The steering wheel heater can also be deactivated via the MBUX voice assistant.

Easy entry and exit feature

Using the easy entry and exit feature

- ⚠ WARNING** Risk of accident when pulling away during the adjustment process of the easy entry and exit feature

You could lose control of the vehicle.

- ▶ Always wait until the adjustment process is complete before driving off.

- ⚠ WARNING** Risk of becoming trapped when adjusting the easy entry and exit feature

You and other vehicle occupants, particularly children, may become trapped.

- ▶ Make sure that no one has any part of their body within the range of movement of the steering wheel and driver's seat.

If there is a risk of becoming trapped by the steering wheel:

- ▶ Move the steering wheel adjustment lever.
The adjustment process is stopped.

If there is a risk of becoming trapped by the driver's seat:

- ▶ Press the switch for seat adjustment.
The adjustment process is stopped.
- ▶ Never leave children unattended in the vehicle.
- ▶ When leaving the vehicle, always take the key with you and lock the vehicle.

Vehicles with memory function: you can stop the adjustment process by pressing one of the memory function position switches.

⚠ WARNING Risk of becoming trapped if children activate the easy entry and exit feature

Children could become trapped if they activate the easy entry and exit feature, particularly when unattended.

- ▶ Never leave children unattended in the vehicle.
- ▶ When leaving the vehicle, always take the key with you and lock the vehicle.

If the easy entry and exit feature is active, the steering wheel will move upwards and the driver's seat will move to a suitable position for getting in or out of the vehicle in the following situations:

- You switch off the vehicle when the driver's door is open.
- You open the driver's door when the vehicle is switched off.

- ⓘ The steering wheel will then move upwards only if it is not already as high as it will go. The driver's seat will move forwards or back-

wards only if it is not already in the ideal position for getting in or out of the vehicle.

The driver's seat backrest will then move forwards only if it is not already in the front-most position.

The steering wheel and the driver's seat will move back to the last driving position in the following cases:

- You switch the power supply or the vehicle on when the driver's door is closed.
- You close the driver's door when the vehicle is switched on.

The last drive position will be saved when:

- If you switch off the vehicle.
- **Vehicles with memory function:** you call up the seat settings via the memory function.
- **Vehicles with memory function:** you save the seat settings via the memory function.

Vehicles with memory function: press one of the memory function position switches to stop the adjustment process.

Setting the easy entry and exit feature

Requirements:

- The automatic seat adjustment has been activated (→ page 105).
- The power supply or the vehicle has been switched on.

Multimedia system:

→  » Settings » Vehicle » Comfort
» Easy Entry And Exit Feature

Setting the easy entry and exit feature

▶ Select **Steering Wheel & Seat, Steering Wheel Only** or **Off**.

-  If you are using a custom user profile, this information will be used for the easy entry and exit feature. This will cause the driver's seat and steering wheel to move into the correct position automatically (→ page 289).

Memory function

Function of the memory function

 **WARNING** Risk of an accident if the memory function is used while driving

If you use the memory function on the driver's side while driving, you could lose control of the vehicle as a result of the adjustments being made.

- ▶ Only use the memory function on the driver's side when the vehicle is stationary.

 **WARNING** Risk of entrapment when adjusting the seat with the memory function

When the memory function adjusts the seat, you and other vehicle occupants – particularly children – could become trapped.

- ▶ During the adjustment process of the memory function, make sure that no one

has any body parts in the sweep of the seat.

- ▶ If someone becomes trapped, press a preset position button or seat adjustment switch immediately.

 **WARNING** Danger of entrapment when memory function is activated by children

When children activate the memory function, they can get trapped, especially if they are unsupervised.

- ▶ Never leave children unattended in the vehicle.
- ▶ When leaving the vehicle, always take the key with you and lock the vehicle.

You can use the memory function when the ignition is switched off.

Seat adjustments for up to three people can be stored and called up using the memory function.

You can save settings for the following systems:

- Front seat
- Outside mirrors

- Head-up display
- Steering column
- Seat contour

Operating the memory function

Storing

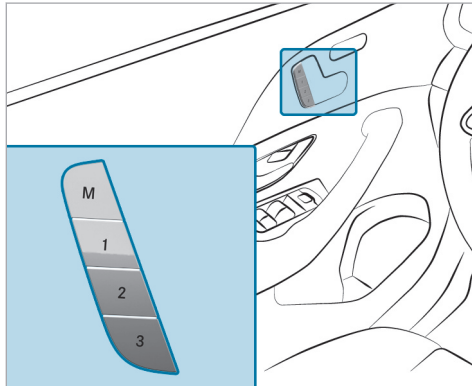

- ▶ Set the desired position for all systems.

- ▶ Press memory button **M** and then press preset position button **1**, **2** or **3** within three seconds.

An acoustic signal sounds. The settings are stored.

- ▶ **To call up:** press or briefly hold preset position button **1**, **2** or **3**. After releasing the button, all systems are moved into the stored position.

Stowage areas

Notes on loading the vehicle

⚠ DANGER Risk of exhaust gas poisoning

Combustion engines emit poisonous exhaust gases such as carbon monoxide. Exhaust gases can enter the vehicle interior if the tailgate is open when the engine is running, especially if the vehicle is in motion.

- ▶ Always switch off the engine before opening the tailgate.
- ▶ Never drive with the tailgate open.

Objects in the deployment area of an air bag may prevent the air bag from functioning correctly. Observe the notes on air bags (→ page 57).

⚠ WARNING Risk of injury from unsecured items in the vehicle

If objects, luggage or loads are not secured or not secured sufficiently, they could slip, tip over or be thrown around and thereby hit vehicle occupants.

There is a risk of injury, particularly in the event of sudden braking or a sudden change in direction.

- ▶ Always stow objects in such a way that they cannot be thrown around.
- ▶ Before the journey, secure objects, luggage or loads against slipping or tipping over.

⚠ WARNING Risk of injury due to objects being stowed incorrectly

If objects in the vehicle interior are stowed incorrectly, they can slide or be thrown around

and hit vehicle occupants. In addition, cup holders, open storage spaces and mobile phone receptacles cannot always retain all objects within.

There is a risk of injury, particularly in the event of sudden braking or abrupt changes in direction.

- ▶ Always store objects such that they cannot be thrown around in such situations.
- ▶ Always make sure that objects do not protrude from storage spaces, parcel nets or storage nets.
- ▶ Close the lockable storage spaces before starting a journey.
- ▶ Stow and secure objects that are heavy, hard, pointed, sharp-edged, fragile or too large in the cargo compartment.

⚠ WARNING Risk of accident due to objects in the driver's and front-passenger footwell

Objects in the driver's and front-passenger footwell may impede pedal travel or block a depressed pedal.

This jeopardizes the operating- and road safety of the vehicle.

- ▶ Stow all objects in the vehicle securely so that they cannot get into the driver's or front-passenger footwell.
- ▶ Always ensure that the pedals have sufficient free space.
- ▶ Always install the floor mats securely and as prescribed.
- ▶ Do not use loose floor mats and do not place floor mats on top of one another.

Vehicles with automatic front passenger air bag shut-off: objects trapped under the front passenger seat may interfere with the function of automatic front passenger air bag shutoff or damage the system. Therefore please observe the

notes on the function of automatic front passenger air bag shutoff (→ page 48).

⚠ WARNING - Risk of accident or injury when using the cup holder while the vehicle is moving

The cup holder cannot secure containers while the vehicle is moving.

If you use a cup holder while the vehicle is moving, the container may be flung around and liquids may be spilled. The vehicle occupants may come into contact with the liquid and if it is hot, they could be scalded. You could be distracted from traffic conditions and you may lose control of the vehicle.

- ▶ Only use the cup holder when the vehicle is stationary.
- ▶ Only use the cup holder for containers of the right size.
- ▶ Close the container, particularly if the liquid is hot.

! NOTE Damage to the cup holder

The cup holder can be damaged when folding back the rear armrest. When open, the cup holder can be damaged by body weight.

- ▶ The rear armrest can only be folded back when the cup holder is closed.
- ▶ Do not sit or support yourself on the cup holder when it is open.

! NOTE Damage to the vehicle caused by spilled liquids

If liquids are spilled in the vehicle, parts of the vehicle may be damaged.

- ▶ Always securely close containers containing liquids that you have brought with you.
- ▶ Clean the vehicle as soon as possible if liquids are spilled.
- ▶ If larger quantities of liquids are spilled, have the vehicle checked in a qualified specialist workshop.

! NOTE Damage to the rear armrest due to body weight

When folded out, the rear armrest can be damaged by body weight.

- ▶ Do not sit or support yourself on the rear seat armrest.

! WARNING Risk of injury due to an open cargo compartment floor

If you drive with the cargo compartment floor open, objects could be flung around and hit vehicle occupants as a result. There is a risk of injury, particularly in the event of sudden braking or a sudden change in direction.

- ▶ Always close the cargo compartment floor before a journey.

! WARNING Risk of fire and injury from hot cigarette lighter

You can suffer burns if you touch the hot heating element or the hot socket of the cigarette lighter.

In addition, flammable materials can catch fire if:

- you drop the hot cigarette lighter.
 - children e.g. hold the hot cigarette lighter to objects.
- ▶ Always hold the cigarette lighter by the knob.
 - ▶ Always make sure that the cigarette lighter is out of the reach of children.
 - ▶ Never leave children unattended in the vehicle.

! WARNING Risk of burns from the tailpipe and tailpipe trims

The exhaust tailpipe and tailpipe trims can become very hot. If you come into contact with these parts of the vehicle, you could burn yourself.

- ▶ Always be particularly careful around the tailpipe and the tailpipe trims and super-

vises children especially closely in this area.

- ▶ Allow vehicle parts to cool down before touching them.

! **NOTE** Damage to the cargo floor caused by an unevenly distributed load or an abrupt application of load.

The cargo floor may be damaged by an unevenly distributed load or an abrupt application of load.

- ▶ Distribute the load evenly.
- ▶ Drive carefully when the vehicle is laden. Avoid abrupt starts, braking and steering as well as rapid cornering.

- i** Leather is a natural product. It exhibits natural surface characteristics, such as differences in structure, marks caused by growth and injury or subtle color differences. These surface characteristics are particular to leather, and are not material defects. Leather is also sub-

ject to a natural aging process, which changes the surface characteristics.

The handling characteristics of your vehicle are dependent on the distribution of the load within the vehicle. You should bear the following in mind when loading the vehicle:

- Never allow the payload including occupants to exceed the gross vehicle weight rating or the gross axle weight rating for the vehicle. The values are specified on the vehicle identification plate on the vehicle's B-pillar.
- The load must not protrude above the upper edge of the seat backrests.
- Always use the partitioning net when carrying objects in the cargo compartment.
- Always place the load behind unoccupied seats if possible.
- Secure the load using the tie-down eyes and distribute the tension evenly.

Notes on carrying a roof load:

- Distribute the roof load and vehicle load evenly, and place heavy objects at the bottom. Also observe the notes on loading the vehicle.
- Drive with care. Avoid abrupt starts, braking and steering maneuvers as well as fast cornering.
- When carrying a roof load or when the vehicle is fully loaded or occupied, select drive program **E** or **C**. These are configured for good stability (→ page 170).
- i** Further information on storage compartments and stowage facilities can be found in the Digital Operator's Manual.

Stowage spaces in the vehicle interior

Overview of the front storage compartments

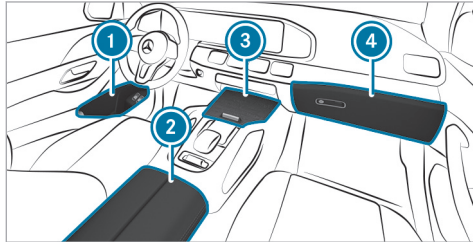

- ① Stowage spaces in the doors
- ② Storage compartment in the armrest with USB ports (depending on the vehicle equipment)
- ③ Storage/telephone compartment with cup holder in the front center console
- ④ Glove box

Through-loading feature in the rear bench seat (EASY-PACK Quickfold)

Folding the rear seat backrest forwards

⚠ WARNING Risk of becoming trapped when adjusting the seats

When you adjust a seat, you may trap yourself or a vehicle occupant.

- ▶ When adjusting a seat, make sure that no one has any body parts in the sweep of the seat.

⚠ WARNING Risk of accident and injury if the seat and seat backrest are not engaged

The seat and seat backrest can fold forwards.

There is a risk of the following, in particular:

- The vehicle occupant may be pressed against the seat belt. The seat belt cannot provide the intended protection and could

cause additional injury to the vehicle occupant.

- A child restraint system is no longer properly supported or correctly positioned and can no longer perform its function as intended.
- The seat backrest will not be able to restrain objects or goods in the cargo compartment.

Always ensure that the seat and seat backrest are engaged, in particular:

- Before persons travel in the vehicle while sitting on a seat with the easy entry and exit feature
- After the seat has been adjusted.
- After the easy entry and exit feature has been used
- After the cargo compartment enlargement has been folded forwards

Always ensure that all vehicle occupants have their seat belts fastened correctly and are sitting

properly. Particular attention must be paid to children.

If you no longer require the folded-down rear seat backrest as a load area, fold the backrest back into place.

Make sure that the red marking of the lock verification indicator is no longer visible. Otherwise, the seat backrest will not be locked.

Folding the rear seats forwards manually

! **NOTE** Damage to the headliner when the rear seat backrests are folded forwards and backwards

The headliner could be damaged when the seat backrests are folded forwards and backwards.

- ▶ Before you fold the seat backrests forwards and backwards, insert the head restraints.

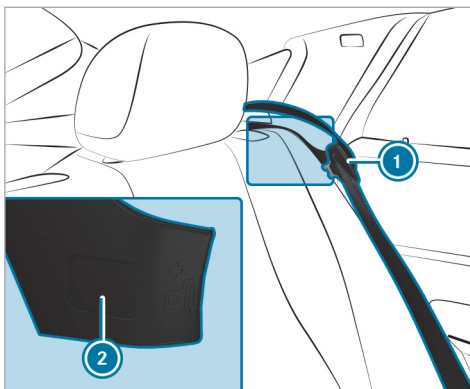

- ▶ Press the seat belt tongue of seat belt ① into marked position ②.

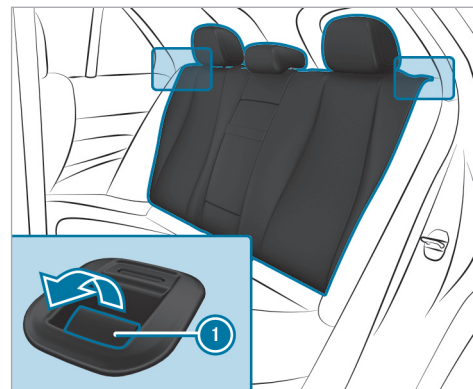

- ▶ Move the driver's or front passenger seat forwards, if necessary.
- ▶ **To fold the left and right seat backrests forwards:** insert the head restraints for the seat backrests (→ page 104).
- ▶ Pull release lever ①.
- ▶ Fold the corresponding seat backrest forwards.

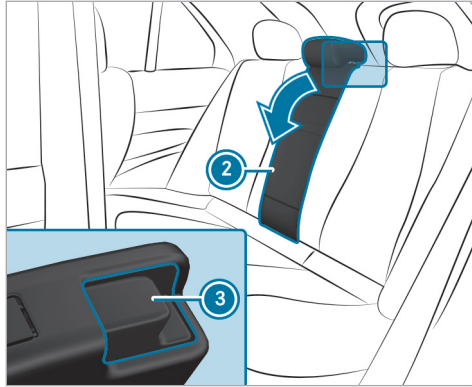

- ▶ Fold the rear seat armrest back if necessary.
- ▶ **To fold the center seat backrest forwards:** press release catch ③.
- ▶ Fold seat backrest ② forwards.

Observe the following recommendations:

- If you wish to fold only one of the outer seat backrests forwards, it is recommended that you fold the right seat backrest forwards.

- If you wish to fold one of the outer seat backrests forwards together with the center seat backrest, it is recommended that you fold the left and center seat backrests forwards.

Folding back the rear seat backrest

! **NOTE** Damage caused by trapping the seat belt when the seat backrest is folded back

The seat belt could become trapped and thus damaged when the seat backrest is folded back.

- ▶ Ensure that the seat belt tongue has been inserted at the side in the marked position.

! **NOTE** Damage to the headliner when the rear seat backrests are folded forwards and backwards

The headliner could be damaged when the seat backrests are folded forwards and backwards.

- ▶ Before you fold the seat backrests forwards and backwards, insert the head restraints.

Folding back the rear seat mechanically

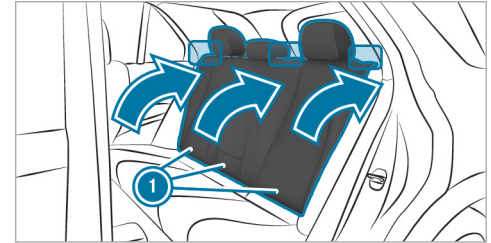

- ▶ Move the driver's or front passenger seat forwards, if necessary.
- ▶ Swivel seat backrest ① back until it engages.
- ▶ Make sure that the red marking of the lock verification indicator is no longer visible. Otherwise, the seat backrest is not locked.

Collapsible cargo compartment cover

Notes on the collapsible cargo compartment cover

⚠ WARNING Risk of injury or death due to poorly secured objects

The cargo compartment cover alone cannot secure or restrain heavy objects, items of luggage or heavy loads.

You could be hit by an unsecured load, particularly in the event of abrupt changes in direction, sudden braking or an accident.

- ▶ Always stow objects in such a way that they cannot be thrown around.
- ▶ Secure objects, luggage or loads against slipping or tipping over, e.g. by using tie downs, even if you are using the cargo compartment cover.

! **NOTE** Damage to the collapsible cargo compartment cover when the vehicle is being loaded

When the vehicle is being loaded, the collapsible cargo compartment cover may be damaged.

- ▶ Do not place any objects above the lower edge of the side windows or on the collapsible cargo compartment cover.

Unfolding the collapsible cargo compartment cover

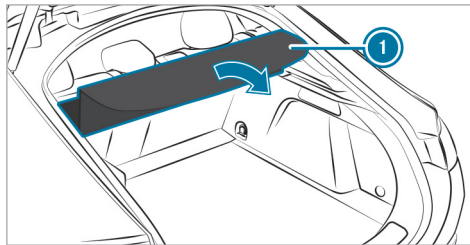

- ▶ Lift collapsible cargo compartment cover ① by the handle, unfold it in the direction of the arrow and place it on the edge.

Folding up the collapsible cargo compartment cover

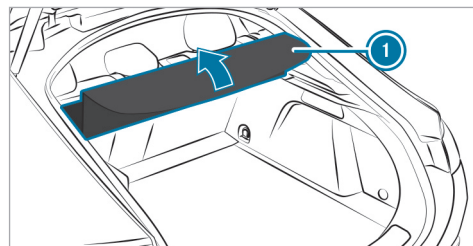

- ▶ Lift collapsible cargo compartment cover ① by the handle, guide it forwards in the direction of the arrow until it has completely folded up and stow it away in the folded state.

Installing and removing the collapsible cargo compartment cover

Requirements:

- The collapsible cargo compartment cover is folded up.

Removing the collapsible cargo compartment cover

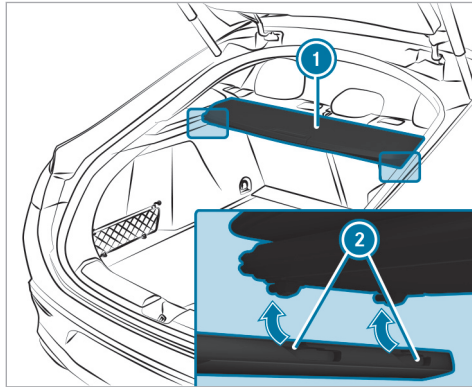

- Pull collapsible cargo compartment cover (1) towards the rear by the bottom, folded-up section and remove it in the direction of the arrow from brackets (2) on the left and right.

Installing the collapsible cargo compartment cover

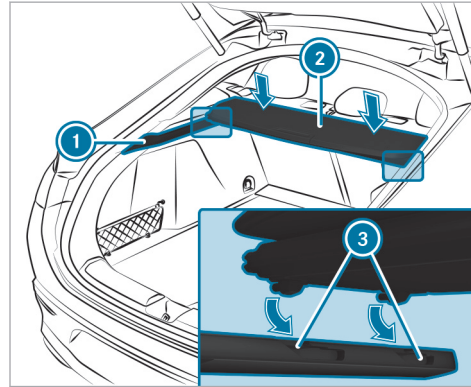

- Place collapsible cargo compartment cover (2) on edge (1).

- Place collapsible cargo compartment cover (2) into the brackets on the left and right (3) and push it forwards in the direction of the arrow. The end caps of the collapsible cargo compartment cover will engage.

Overview of the tie-down eyes in the cargo compartment

Observe the notes on loading the vehicle (→ page 113).

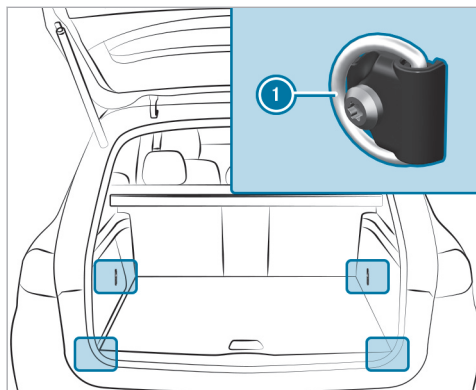

1 Tie-down eyes

Overview of bag hooks

⚠ WARNING Risk of injury when using bag hooks with heavy objects

The bag hooks cannot restrain heavy objects or items of luggage.

Objects or items of luggage may be flung around and hit vehicle occupants.

- ▶ Only hang light objects on the bag hooks.
- ▶ Never hang hard, sharp-edged or fragile objects on the bag hooks.

Observe the notes on loading the vehicle (→ page 113).

The bag hook can bear a maximum load of 6.6 lbs (3 kg). Do not use it to secure a load.

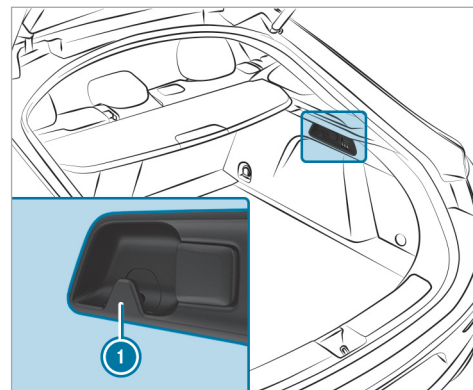

1 Bag hook

Coat hook on the tailgate

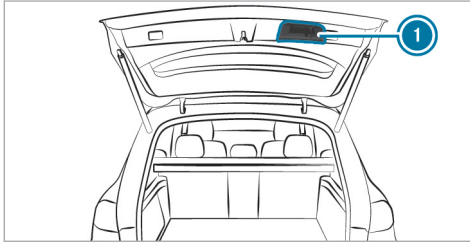

① Coat hook on the tailgate

Coat hooks are not suitable for heavy objects. Use the coat hooks only for light objects such as jackets.

Using the clothes hooks in the rear passenger compartment

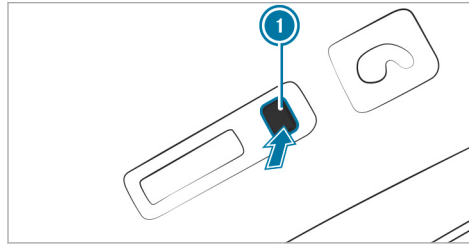

- ▶ Press the bottom of clothes hook ①. Clothes hook ① will extend.
- ① Observe the notes on loading the vehicle (→ page 113).

EASY-PACK load-securing kit

■ Notes on the snap-in module for the cargo compartment (telescopic rod)

The EASY-PACK load-securing kit allows you to use your cargo compartment for a variety of pur-

poses. The components are located in the stowage space under the cargo floor.

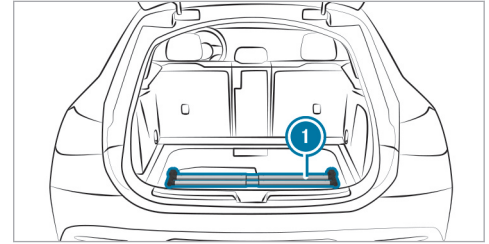

- ① Telescopic rod with mounting elements and holders

■ Installing a telescopic rod

⚠ WARNING Risk of injury due to an open cargo compartment floor

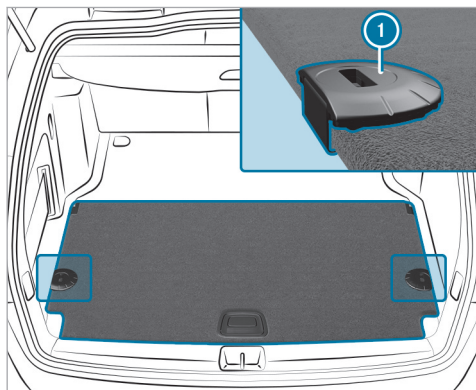

If you drive with the cargo compartment floor open, objects could be flung around and hit vehicle occupants as a result. There is a risk of injury, particularly in the event of sudden braking or a sudden change in direction.

- ▶ Always close the cargo compartment floor before a journey.

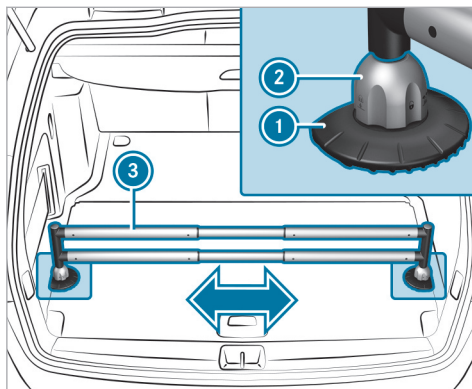

- ▶ Open the cargo floor .
- ▶ Attach holders ① in the desired position to the side of the cargo floor.
- ▶ Close the cargo floor.



- ▶ Turn the mounting elements ② to .
- ▶ Insert the mounting elements ② into the holders ① .
- ▶ Extend the telescopic rod ③ .
- ▶ Insert the telescopic rod ③ into the mounting elements ② .
- ▶ Turn both mounting elements ② to  until you feel them engage.

Locking and unlocking the cargo compartment floor

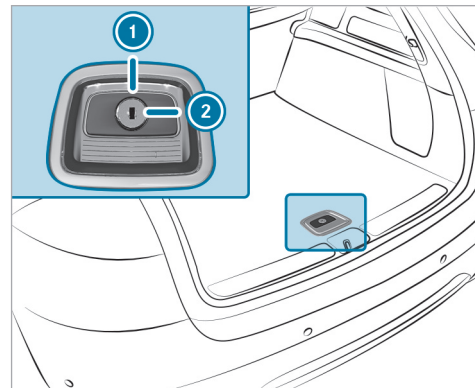

- ▶ Turn the emergency key a quarter turn clockwise ② (to lock) or counter-clockwise ① (to unlock).

Attaching a roof luggage rack

⚠ WARNING Risk of accident due to exceeding the maximum roof load

The vehicle center of gravity and the usual driving characteristics as well as the steering and braking characteristics alter.

If you exceed the maximum roof load, the driving characteristics, as well as steering and braking, will be greatly impaired.

- ▶ Never exceed the maximum roof load and adjust your driving style.

Vehicle-specific weight information can be found on the vehicle identification plate.

! NOTE Vehicle damage due to failure to observe the maximum permissible clearance height

If the vehicle height exceeds the maximum permissible clearance height, the roof and other vehicle parts may be damaged.

- ▶ Please observe the maximum clearance height indicated.
- ▶ If the vehicle exceeds the permissible clearance height, do not drive in.
- ▶ Take the modified vehicle height into account in the case of roof superstructures or other carrier systems.

! NOTE Vehicle damage from non-approved roof luggage racks

The vehicle could be damaged by roof luggage racks that have not been tested and approved for Mercedes-Benz.

- ▶ Use only roof luggage racks tested and approved for Mercedes-Benz.
- ▶ Depending on the vehicle equipment, ensure that the sliding sunroof can be fully raised when the roof luggage rack is installed.
- ▶ Depending on the vehicle equipment, ensure that the trunk lid can be fully

opened when the roof luggage rack is installed.

- ▶ Position the load on the roof luggage rack in such a way that the vehicle will not sustain damage even when it is in motion.

! NOTE Damage to the panorama roof with power tilt/sliding panel due to non-approved roof luggage racks

The panorama roof with power tilt/sliding panel may be damaged by the roof luggage rack if you attempt to open it when using a roof luggage rack not tested and approved for Mercedes-Benz.

- ▶ When a roof luggage rack is installed, open the panorama roof with power tilt/sliding panel only if this has been tested and approved for Mercedes-Benz.

The panorama roof with power tilt/sliding panel may be raised to allow ventilation of the vehicle interior.

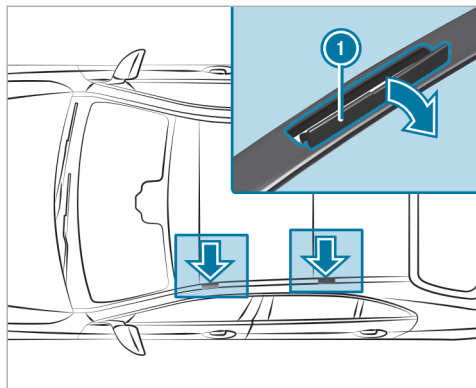

! **NOTE** Damage to the covers

The covers may be damaged and scratched when being opened.

- ▶ Do not use metallic or hard objects.

- ▶ Fold covers ① carefully upwards in the direction of the arrow.

- ▶ Secure the roof luggage rack to the fastening points beneath covers ①.
- ▶ Comply with the installation instructions of the roof luggage rack manufacturer.
- ▶ Secure the load on the roof luggage rack.

Cup holder

Switching the cooling or heating function for the temperature-controlled cup holder on or off

! **WARNING** Risk of injury by touching the heating elements

The cup holder's heating elements may be very hot.

You can burn yourself on them.

- ▶ Do not touch the cup holder's hot heating elements.
- ▶ Ensure that no children can access the cup holder's hot heating elements.
- ▶ Never leave children unattended in the vehicle.

! **NOTE** Damage to objects in the temperature-controlled cup holder

If you place objects into the temperature-controlled cup holder, they may become damaged.

- ▶ Do not place objects into the temperature-controlled cup holder.

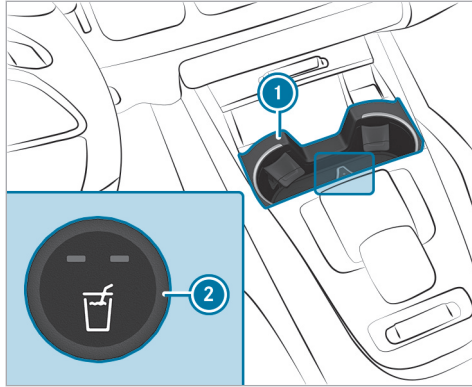

Cup holder in the front center console

- ▶ **To switch on:** on cup holder ①, press button ② repeatedly until the blue (keep cool) or red (keep warm) indicator lamp on the button lights up.

If you use the heating function, the metal insert of the cup holder will be heated. Once a certain temperature has been reached, the warning lamp will light up. Do not reach into

the cup holder's metal insert when the warning lamp is lit.

- ▶ **To switch off:** press button ② repeatedly until the indicator lamp on the button goes out.
- ⓘ Clean the removable rubber mat only with clean, lukewarm water and the cup holder only with a soft cloth.

Ashtray and cigarette lighter

Using the ashtray

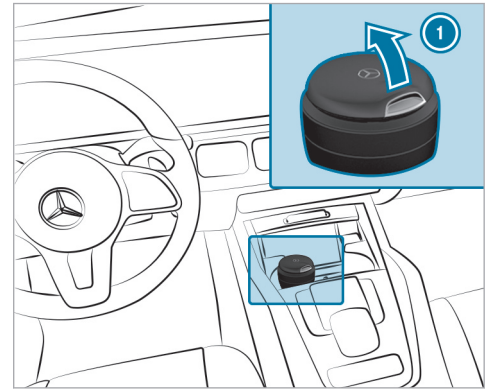

- ▶ Place the ashtray in one of the cup holders in the center console or in the rear passenger compartment.
- ▶ Check that it is seated firmly.
- ▶ Comply with the notes on loading the vehicle (→ page 113).

▶ **To open the ashtray:** fold lid ① upwards.

① You can remove the top part of the ashtray for cleaning or emptying by twisting it. Clean the ashtray, e.g. with clean, lukewarm water.

Sockets

Using the 12 V socket

Requirements:

- Only connect devices up to a maximum of 240 W (20 A).

Depending on the vehicle equipment, the vehicle has the following 12 V sockets:

- In the stowage compartment in the front center console
- In the cargo compartment

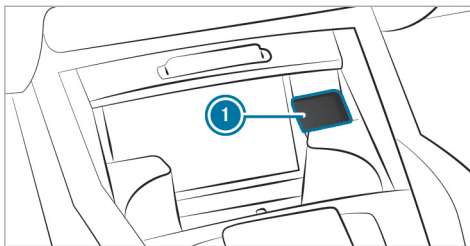

Example: 12 V socket in the stowage compartment in the front center console

▶ Lift up cap ① of the socket and insert the plug of the device.

If you have connected a device to the 12 V socket, leave the cover of the stowage compartment open.

Using the 115 V socket in the rear passenger compartment

⚠ DANGER Risk of fatal injuries due to a damaged connecting cable or a damaged socket

You could receive an electric shock if the connecting cable or the 115 V power socket is pulled out of the trim or is damaged or wet.

- ▶ Use only connecting cables that are dry and free of damage.
- ▶ When the vehicle is switched off, make sure that the 115 V power socket is dry.
- ▶ Immediately have the 115 V power socket checked or replaced at a qualified specialized workshop if it is damaged or has been pulled out of the trim.
- ▶ Never plug the connecting cable into a 115 V power socket that is damaged or has been pulled out of the trim.

⚠ DANGER Risk of death due to using the socket incorrectly

In particular, you could receive an electric shock:

- If you touch the inside of the socket
- If you insert unsuitable devices or objects into the socket

- ▶ Do not touch the inside of the socket.
- ▶ Only connect suitable devices to the socket.

Requirements

- Connect only devices with a suitable plug that conforms to the standards specific to the country you are in.
- Connect only devices up to a maximum of 150 W (1.3 A).
- Do not use multiple socket outlets.

Depending on the vehicle equipment, the design of the center console and stowage compartment may differ.

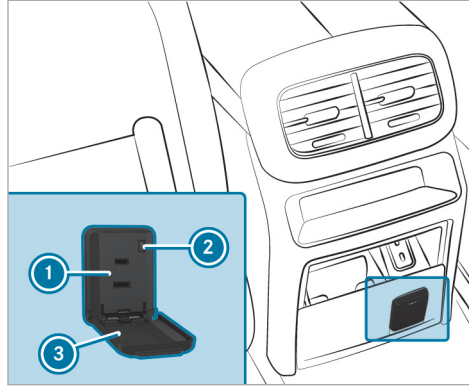

- ▶ Mercedes-Maybach vehicles with individual rear seats: open the stowage compartment of the center console of the rear passenger compartment .
- ▶ Open flap ③ .
- ▶ Insert the plug of the device into 115 V socket ① .
When the on-board electrical system voltage is sufficient, indicator lamp ② lights up.

Overview of USB ports

Depending on the vehicle equipment, the vehicle has the following USB ports:

- in the storage compartment of the cockpit armrest (→ page 117)
- in the front center console next to the mobile phone holder
- in the rear center console

If the vehicle is switched on you can charge USB devices such as mobile phones. Depending on the vehicle equipment, the charging capacity is up to 100 W.

Wireless charging of the mobile phone and connection with the exterior antenna

Notes on wirelessly charging a mobile phone

⚠ WARNING Risk of injury due to objects being stowed incorrectly

If objects in the vehicle interior are stowed incorrectly, they can slide or be thrown around

and hit vehicle occupants. In addition, cup holders, open stowage spaces and mobile phone receptacles cannot always retain all objects within.

There is a risk of injury, particularly in the event of sudden braking or a sudden change in direction.

- ▶ Always stow objects so that they cannot be thrown around in such situations.
- ▶ Always make sure that objects do not protrude from stowage spaces, parcel nets or stowage nets.
- ▶ Close the lockable stowage spaces before starting a journey.
- ▶ Always stow and secure heavy, hard, pointed, sharp-edged, fragile or bulky objects in the trunk/cargo compartment.

Observe the notes on loading the vehicle.

⚠ WARNING Risk of fire from placing objects in the mobile phone storage compartment

Placing other objects in the mobile phone storage compartment could constitute a fire hazard.

- ▶ Apart from a mobile phone, do not place any other objects in the mobile phone storage compartment, especially those made of metal.

! NOTE Damage to objects caused by placing them in the mobile phone storage compartment

If objects are placed in the mobile phone storage compartment, these may be damaged by electromagnetic fields.

- ▶ Do not place credit cards, storage media, ski passes or other objects sensitive to electromagnetic fields in the mobile phone storage compartment.

! NOTE Damage to the mobile phone stowage compartment caused by liquids

If liquids enter the mobile phone stowage compartment, the compartment may be damaged.

- ▶ Ensure that no liquids enter the mobile phone stowage compartment.

Always observe the notes for persons with electronic medical aids (→ page 33).

- Depending on the vehicle equipment, the mobile phone is connected to the vehicle's exterior antenna via the charging module.
- The charging function and wireless connection of the mobile phone to the vehicle's exterior antenna are available only if the vehicle is switched on.
- Small mobile phones may not be able to be charged in every position of the mobile phone stowage compartment.
- Large mobile phones that do not rest flat in the mobile phone stowage compartment may

not be able to be charged or connected with the vehicle's exterior antenna.

- The mobile phone may heat up during the charging process. This may also depend on the applications (apps) currently open in the background.
- To ensure more efficient charging and connection with the vehicle's exterior antenna, remove the protective cover from the mobile phone. Protective covers that are necessary for wireless charging are an exception.

Wireless charging of a mobile phone in the cockpit

Requirements

- The mobile phone is suitable for wireless charging.
- i** A list of compatible mobile phones can be found at: <https://www.mercedes-benz-mobile.com/>

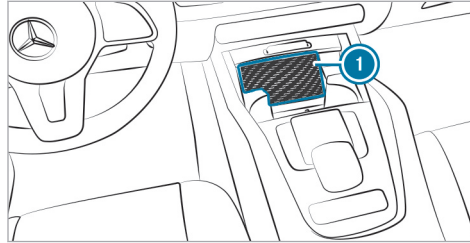

- ▶ Place the mobile phone as close to the center of mat **1** as possible with the display facing upwards. When a message is shown in the multimedia system, the mobile phone is being charged. Malfunctions detected during the charging process are shown in the multimedia system display.
- i** The mat can be removed for cleaning, e.g. using clean, lukewarm water.

Installing/removing the floor mats

⚠ WARNING Risk of accident due to objects in the driver's footwell

Objects in the driver's footwell may impede pedal travel or block a depressed pedal.

This will jeopardize the operating- and road safety of the vehicle.

- ▶ Stow all objects in the vehicle securely so that they cannot get into the driver's footwell.
- ▶ Make sure that there is always sufficient clearance for the pedals.
- ▶ Always install the floor mats securely and as prescribed.
- ▶ Do not use loose floor mats and do not place floor mats on top of one another.

Installing floor mats

- ▶ Remove the floor mat.

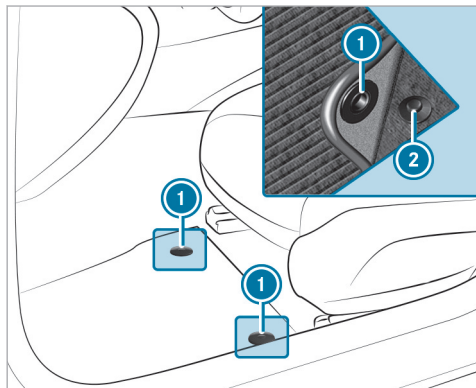

- ▶ Move the corresponding seat backwards and lay the floor mat in the footwell.
- ▶ Press studs ① onto holders ②.
- ▶ Adjust the corresponding seat.

Removing floor mats

- ▶ Pull the floor mat off holders ②.

Exterior lighting

Information about lighting systems and your responsibility

The various lighting systems of the vehicle are only aids. The driver of the vehicle is responsible for correct vehicle illumination in accordance with the prevailing light and visibility conditions, legal requirements and traffic situation.

Light switch

Operating the light switch

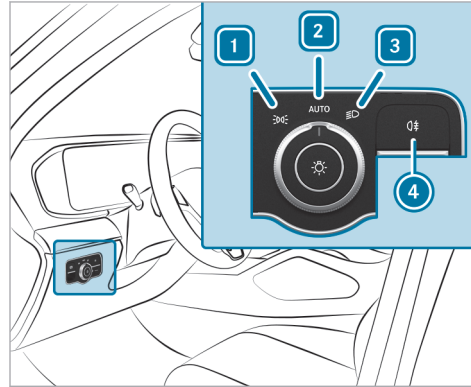

- 1 Parking lights and license plate lamp
- 2 Automatic driving lights (preferred light switch position)
- 3 Low beam/high beam
- 4 Switches the rear fog light on/off.

When low beam is activated, the indicator lamp for the parking lights will be deactivated and replaced by the low-beam indicator lamp.

▶ Always park your vehicle safely using sufficient lighting, in accordance with the relevant legal stipulations.

! **NOTE** Battery discharging by operating the parking lamps

Do not have the parking lamps switched on over a period of several hours.

If the battery is heavily discharged, the parking lights will be switched off automatically to facilitate the next vehicle start.

The exterior lighting (except parking lights) will switch off automatically when the driver's door is opened.

- Observe the notes on locator lighting (→ page 138).

Switching on accident scene lighting

▶ Switch off the vehicle.

- ▶ Switch on the hazard warning lights (→ page 135).
- ▶ Turn the light switch from the **AUTO** position to the  position.
The low beam will be switched on despite the vehicle being switched off.

The accident scene lighting will be switched off if:

- you switch off the hazard warning lights.
- you turn the light switch back to **AUTO**.
- the battery is insufficiently charged.

Automatic driving lights function

When the vehicle is switched on, the standing lights, low beam and daytime running lights will be switched on automatically depending on the ambient light.

⚠ WARNING Risk of accident when the low beam is switched off in poor visibility

When the light switch is set to **AUTO**, the low beam may not be switched on automatically if there is fog, snow or other causes of poor visibility such as spray.

▶ In such cases, turn the light switch to .

The automatic driving lights are only an aid. You are responsible for the vehicle lighting.

Switching the rear fog light on/off

Requirements

- The light switch is in the  or **AUTO** position.

▶ Press button .

Please observe the country-specific laws on the use of rear fog lamps.

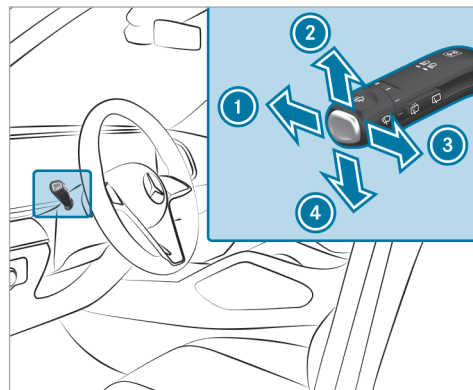

Operating the combination switch for the lights



- ① High beam
- ② Turn signal light, right
- ③ Headlamp flashing
- ④ Turn signal light, left

▶ Use the combination switch to select the desired function.

Switching on high beam

- ▶ Turn the light switch to the  or **AUTO** position.
- ▶ Push the combination switch in the direction of arrow ①.
When high beam is activated, the indicator lamp for low beam  will be deactivated and replaced by the indicator lamp for high beam .

Switching off high beam

- ▶ Push the combination switch in the direction of arrow ① or pull it in the direction of arrow ③.

Headlamp flashing

- ▶ Pull the combination switch in the direction of arrow ③.

Turn signal lights

- ▶ **To indicate briefly:** push the combination switch briefly to the point of resistance in the direction of arrow ② or ④.
The corresponding turn signal light will flash three times.
- ▶ **To indicate permanently:** push the combination switch beyond the point of resistance in the direction of arrow ② or ④.

Vehicles with Active Lane Change Assist:

- A turn signal indicator activated by the driver may continue to operate for the duration of the lane change.
- If the driver indicated directly beforehand but a lane change was not immediately possible, the turn signal indicator may activate automatically.

Activating/deactivating the hazard warning lights

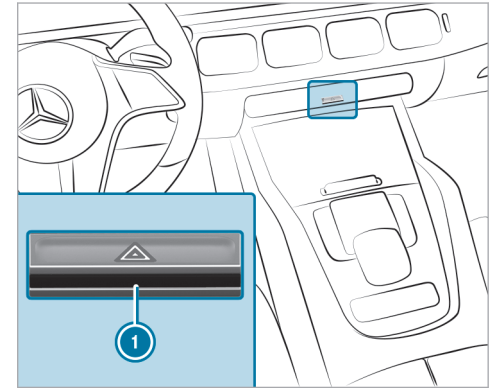

- ▶ Press button ①.

The hazard warning lights will switch on automatically if:

- the air bag has been deployed
- an emergency stop has been initiated (→ page 214)

When the turn signal indicator is activated, the hazard warning lights will be interrupted.

Active headlamps

Active headlamps function

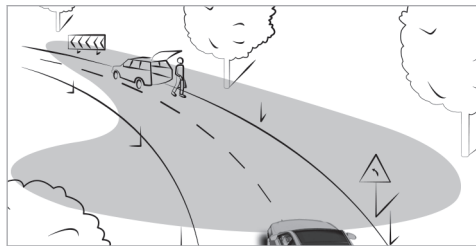

- The headlamps follow the steering movements.
- Relevant areas are better illuminated during a journey.

The functions are active when the low beam is switched on.

Depending on the vehicle's equipment, the course of the lane in which you are driving will also be evaluated and the active headlamps function will adjust the light in advance.

Adaptive Highbeam Assist

Adaptive Highbeam Assist function

⚠ WARNING Risk of accident despite Adaptive Highbeam Assist

Adaptive Highbeam Assist does not react to:

- Road users without lights, e.g. pedestrians
- Road users with poor lighting, e.g. cyclists
- Road users whose lighting is obstructed, e.g. by a barrier

On very rare occasions, Adaptive Highbeam Assist may fail to recognize other road users with their own lighting, or may recognize them too late.

In these, or in similar situations, the automatic high beam will not be deactivated or will be

activated despite the presence of other road users.

- ▶ Always observe the road and traffic conditions carefully and switch off the high beam in good time.

System limits

Adaptive Highbeam Assist cannot take into account road, weather or traffic conditions.

Detection may be restricted in the following cases:

- In poor visibility, e.g. fog, heavy rain or snow
- If there is dirt on the sensors or the sensors are obscured

Adaptive Highbeam Assist is only an aid. You are responsible for adjusting the vehicle's lighting to the prevailing light, visibility and traffic conditions.

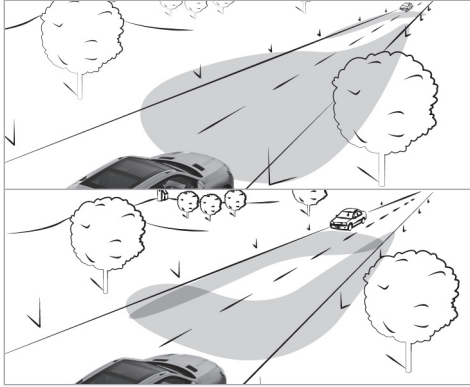

Adaptive Highbeam Assist automatically switches between the following types of light:

- Low beam
- High beam

At speeds greater than 19 mph (30 km/h):

- If no other road users are detected, high beam will switch on automatically.

The high beam will switch off automatically in the following cases:

- At speeds below 16 mph (25 km/h)
- If other road users are detected
- If street lighting is sufficient

At speeds greater than approximately 31 mph (50 km/h):

- The headlamp range of the low beam will be regulated automatically based on the distance to other road users.

i The system's optical sensor is located behind the windshield near the overhead control panel.

Switching Adaptive Highbeam Assist on/off

Switching on

- ▶ Turn the light switch to the **AUTO** position.
 - ▶ Switch on high beam using the combination switch.
- If Adaptive Highbeam Assist is activated, the  indicator lamp will light up on the driver's display.

Switching off

- ▶ Switch off high beam using the combination switch.

Switching the daytime running lights on/off

Multimedia system:

→  » Settings » Light
» Intelligent Light System

- ▶ Switch the **Daytime Running Lights** on or off.
- i** Availability of the function is dependent on the respective country.

Setting the exterior lighting switch-off delay time

Multimedia system:

→  » Settings » Light
» Interior/Exterior Lighting
» Exterior Lighting Switch-off Delay

- ▶ Set a switch-off delay time.
- After parking and locking the vehicle, the exterior lighting will be activated for the set time.

Activating/deactivating locator lighting

Multimedia system:

→  >> Settings >> Light
 >> Interior/Exterior Lighting

▶ Activate or deactivate **Locator Lighting**.





When the function is activated, the exterior lighting will light up for 40 seconds after the vehicle is unlocked or the driver's door is opened when the vehicle is parked and not locked. When you start the vehicle, the locator lighting will be deactivated and the automatic driving lights activated.

Interior lighting

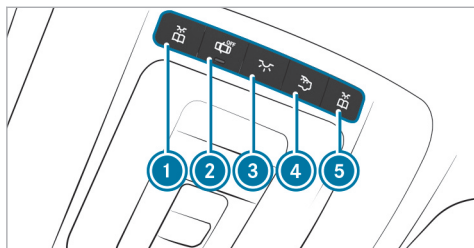
Adjusting the interior lighting

Front overhead control panel



- ①  Front left reading lamp
- ②  Automatic interior lighting control
- ③  Front interior lighting
- ④  Rear interior lighting
- ⑤  Front right reading lamp

▶ **To switch on or off:** press button ① - ⑤ accordingly.

Operating unit in the rear passenger compartment

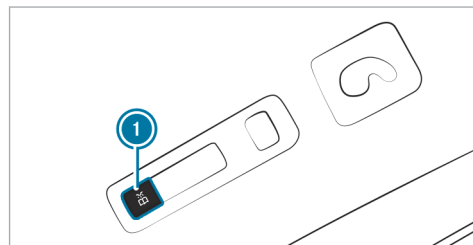

- ①  Rear reading lamp

▶ **To switch on or off:** press the ① button.

Adjusting the ambient lighting

Multimedia system:

→  >> Comfort >> Ambient Light

Setting the color

- ▶ Select **Color**.
- ▶ Select **Monochrome** or **Multi-color**.
- ▶ Set the desired color or color scheme.

Adjusting the brightness

- ▶ Select **Brightness**.
- ▶ Adjust the brightness.
- ⓘ Depending on the ambient light conditions, the ambient lighting will automatically switch between day and night modes.

Activating effects

- ▶ Select **Effects**.
- ▶ Activate the desired effect.
- ⓘ Different effects will be available depending on the vehicle equipment.

Multi-color Animation

- The chosen color combination will change at predefined intervals.

Climate

- If changes are made to the temperature setting in the vehicle, the color of the ambient lighting will change briefly.

Greeting

- When you get into the vehicle, a special color animation will play.

Switching the interior lighting switch-off delay time on/off

Multimedia system:

-  ▶ Settings ▶ Light
- ▶▶ Interior/Exterior Lighting
- ▶▶ Interior Lighting Switch-off Delay



- ▶ Activate or deactivate **Interior Lighting Switch-off Delay**.
If this function is active, the interior lighting will be switched on for a short time after the end of the journey.

Windshield wiper and windshield washer system

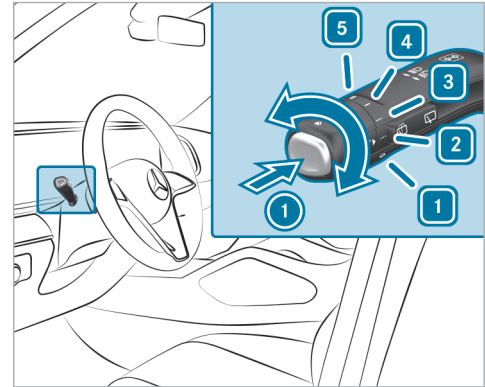
Switching the windshield wipers on or off



- | | | |
|----------|----------|----------------------------|
| 1 | 0 | Windshield wipers off |
| 2 | ... | Automatic wiping, normal |
| 3 | | Automatic wiping, frequent |
| 4 | — | Continuous wiping, slow |
| 5 | == | Continuous wiping, fast |

- ▶ Turn the combination switch to the corresponding position **1** - **5**.
 - ▶  **Single wipe:** press button **1** as far as the pressure point.
 - ▶  **Wiping with washer fluid:** press button **1** beyond the pressure point.
- i** Observe the notes on washing the vehicle in a car wash (→ page 338).

Vehicles with MAGIC VISION CONTROL: in position **2** or **3**, the windshield washing process will automatically be triggered if dirt is detected on the windshield unless the **Add Washer Fluid** message is being displayed.

Replacing the windshield wiper blades

⚠ WARNING Risk of becoming trapped if the windshield wipers are switched on while wiper blades are being replaced

If the windshield wipers begin to move while you are changing the wiper blades, you can be trapped by the wiper arm.

- ▶ Always switch off the windshield wipers and vehicle before changing the wiper blades.

Moving the wiper arms into the replacement position

- ▶ Switch the vehicle on and then off again immediately.
- ▶ Within around 15 seconds, press and hold the  button on the combination switch for approximately three seconds (→ page 139). The wiper arms will move into the replacement position.

Removing the wiper blades

- ▶ Fold the wiper arms away from the windshield.

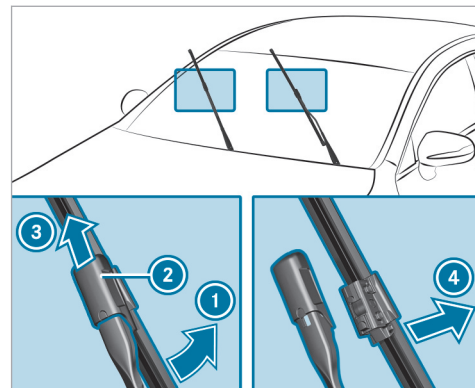

- ▶ Hold the wiper arm with one hand. With the other hand, turn the wiper blade away from the wiper arm in the direction of arrow **1** as far as it will go.
- ▶ Slide catch **2** in the direction of arrow **3** until it engages in the removal position.
- ▶ Remove the wiper blade from the wiper arm in the direction of arrow **4**.

Installing the wiper blades

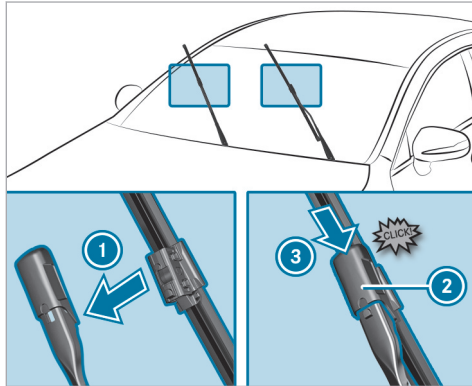

- ▶ Insert the new wiper blade into the wiper arm in the direction of arrow ①.
- ▶ Slide catch ② in the direction of arrow ③ until it engages in the locking position.
- ▶ Make sure that the wiper blade is seated correctly.
- ▶ Fold the wiper arms back onto the windshield.

- ▶ Switch on the vehicle.
 - ▶ Press button  on the combination switch. The wiper arms will return to their original positions.
 - ▶ Switch off the vehicle.
- ⓘ Check the condition of the wiper blades regularly and replace them in the event of visible damage or ongoing smearing.

Maintenance display

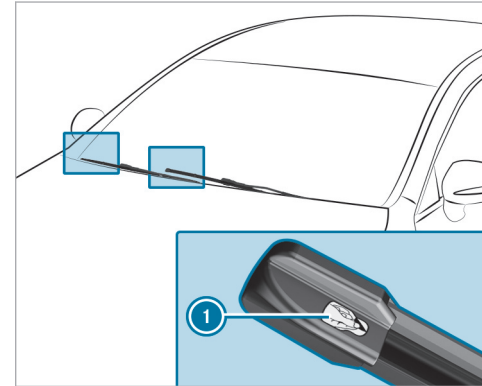

- ▶ Remove protective film ① from the maintenance displays on the tips of the newly installed wiper blades.

When the color of the maintenance displays changes from black to yellow, replace the wiper blades.

- ① The time it takes for the color to change will vary depending on the usage conditions.

Replacing the windshield wiper blades (MAGIC VISION CONTROL)

Moving the wiper arms into the replacement position

- ▶ Switch off the vehicle.
- ▶ Within around 15 seconds, press the  button on the combination switch (→ page 139). The wiper arms will move into the replacement position.

Removing the wiper blades

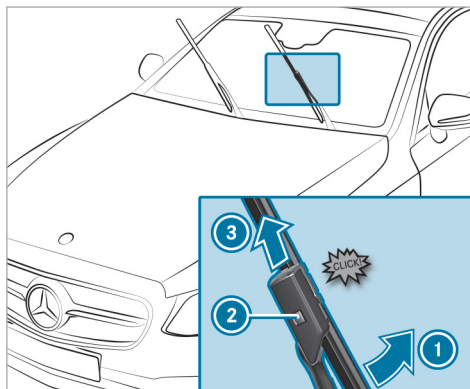

- ▶ **To bring the wiper blade into position to be removed:** hold the wiper arm firmly with one hand. With the other hand, turn the wiper blade in the direction of arrow ① beyond the point of resistance. The wiper blade will engage in the removal position with a click.

- ▶ **To remove the wiper blade:** press release knob ②, pull the wiper blade in the direction of arrow ③ and remove.

Installing the wiper blades

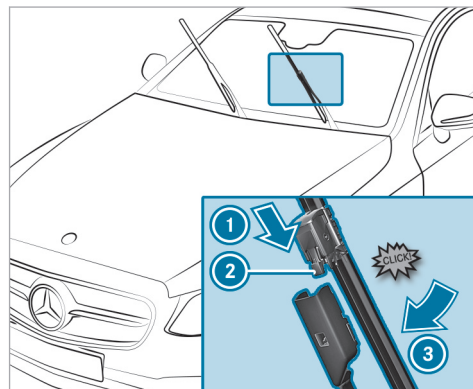

- ▶ Push the new wiper blade onto the wiper arm in the direction of arrow ① until release knob ② engages.

- ▶ Press the wiper blade beyond the point of resistance in the direction of arrow ③ on the wiper arm.
The wiper blade will engage with a noticeable click and move freely again.
- ▶ Fold the wiper arm back onto the windshield.
- ⓘ Check the condition of the wiper blades regularly and replace them in the event of visible damage or ongoing smearing.

Mirrors

Operating the outside mirrors

- ⚠ **WARNING** Risk of accident due to adjusting the vehicle settings while the vehicle is in motion

You could lose control of the vehicle in the following situations in particular:

- If you adjust the driver's seat, the head restraint, the steering wheel or the mirror while the vehicle is in motion

- If you fasten your seat belt while the vehicle is in motion
- ▶ Before starting the vehicle: in particular, adjust the driver's seat, head restraint, steering wheel and mirror, and fasten your seat belt.

- ⚠ **WARNING** Risk of accident due to misjudgment of distance when using the front-passenger mirror

The outside mirror on the front passenger side reflects objects on a smaller scale. The objects in view are in fact closer than they appear.

- ▶ Therefore, always look over your shoulder to check the actual distance between you and the road users traveling behind you.

Folding the outside mirrors in/out

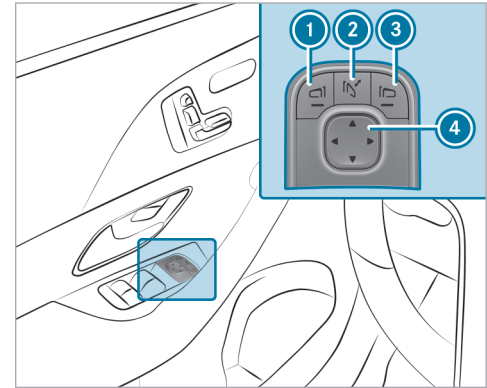

- ▶ Briefly press button ②.
- ⓘ If the battery has been disconnected or has discharged, the outside mirrors must be moved briefly using button ②. Only then will the automatic mirror folding function work properly.

Adjusting the outside mirrors

- ▶ Press button ① or ③ to select the outside mirror to be adjusted.
- ▶ Use button ④ to adjust the position of the mirror glass.

Engaging the outside mirrors

If an outside mirror has been forcibly disengaged, proceed as follows.

- ▶ Vehicles without electrically folding outside mirrors: manually move the outside mirror into the correct position.
- ▶ Vehicles with electrically folding outside mirrors: press and hold button ②. You will hear a click and the mirror will audibly click into place. The outside mirror will now be set to the correct position.

Automatic anti-glare mirrors function

⚠ WARNING Risk of acid burns and poisoning due to the anti-glare mirror electrolyte

Electrolyte may escape if the glass in an automatic anti-glare mirror breaks.

The electrolyte is hazardous to health and causes irritation. It must not come into contact with your skin, eyes, respiratory organs or clothing or be swallowed.

- ▶ If you come into contact with electrolyte, observe the following:
 - Immediately rinse the electrolyte from your skin with water and seek medical attention.
 - If electrolyte comes into contact with your eyes, immediately rinse them thoroughly with clean water and seek medical attention.
 - If the electrolyte is swallowed, immediately rinse your mouth out thoroughly. Do not induce vomiting. Seek medical attention immediately.

- Immediately change out of clothing which has been contaminated with electrolyte.
- If an allergic reaction occurs, seek medical attention immediately.

The inside rearview mirror and the outside mirror on the driver's side will automatically go into anti-glare mode if light from a headlamp hits the sensor on the inside rearview mirror.

System limits

The system will not go into anti-glare mode if:

- The vehicle is switched off.
- Reverse gear is engaged.
- The interior lighting is switched on.

Front-passenger outside mirror parking position function

- ① The parking position is available only in vehicles with a memory function.

The parking position makes parking easier.

In the following situations, the front-passenger outside mirror will swivel downwards in the direction of the rear wheel on the front passenger's side:

- The parking position is stored (→ page 145)
- The front-passenger mirror is selected
- Reverse gear is engaged.

The front-passenger outside mirror will move back to its original position in the following situations:

- You shift the transmission to another transmission position
- You are traveling at speeds greater than 9 mph (15 km/h)
- You press the button for the outside mirror on the driver's side

Storing the parking position of the front-passenger outside mirror using reverse gear

Storing

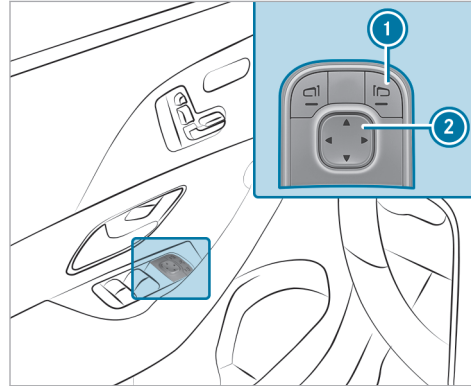

- ▶ Select the front-passenger outside mirror using button ①.
- ▶ Engage reverse gear.

- ▶ Move the front-passenger outside mirror into the desired parking position using button ②.

Calling up

- ▶ Select the front-passenger outside mirror using button ①.
- ▶ Engage reverse gear.
The front-passenger outside mirror will move into the stored parking position.

Activating/deactivating the automatic mirror folding function

Multimedia system:

- ▶ ▶ Settings ▶ Vehicle
- ▶ Open/Close

- ▶ Activate or deactivate Automatic Mirror Folding.

Area permeable to radio waves on the windshield

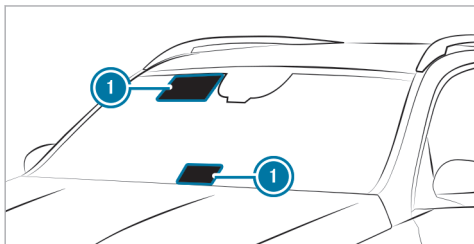

Radio-controlled equipment such as toll systems can be mounted only on areas ① of the windshield that are permeable to radio waves.

Areas permeable to radio waves ① are best visible from outside the vehicle when the windshield is illuminated with an external light source.

Note this position for vehicles with:

- Infra-red reflective windshield

Infrared-reflective windshield function

The infrared-reflective windshield is coated and reduces the build-up of heat in the vehicle interior.

The coating shields the vehicle interior from radio waves.

Overview of climate control systems

Notes on climate control

An interior air filter in combination with the prefilter in the engine compartment must always be used so that the air conditioning system, pollution level monitoring and the air filtration work correctly. Use filters recommended and approved by Mercedes-Benz. Always have maintenance work carried out at a qualified specialist workshop.

Overview of the air conditioning control panel

The indicator lamps on the buttons indicate that the corresponding function is activated.

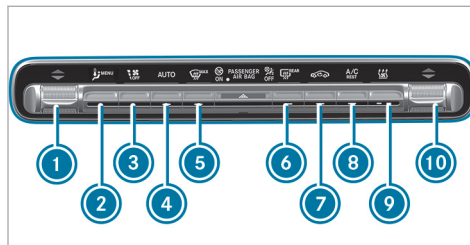

Control panel for dual-zone automatic climate control with stationary heater (example)

- ① Sets the temperature on the driver's side
- ② Calls up/exits the air conditioning menu. Pressing and holding (approx. four seconds); resets climate control to the basic settings
- ③ Sets the airflow or switches off climate control
- ④ **AUTO** Sets climate control to automatic mode (→ page 149)
- ⑤ Defrosts the windshield
- ⑥ Switches the rear window heater on/off

- ⑦ Switches air-recirculation mode on/off (→ page 150)
- ⑧ Switches the A/C function on/off (→ page 148)
Switches residual heat on/off (→ page 151)
- ⑨ Control panel for vehicles with dual-zone or 3-zone automatic climate control without stationary heater: **SYNC** switches synchronization on/off (→ page 150)
Vehicles with control panel for dual-zone or 3-zone automatic climate control with stationary heater: switches stationary heater on/off
- ⑩ Sets the temperature on the front passenger side

Overview of the rear operating unit

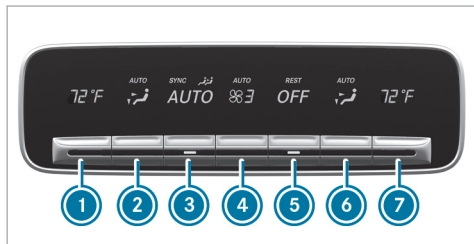

Example: USA

- ① Sets the temperature, left
- ② Sets the air distribution, left
- ③ Sets climate control to automatic mode (→ page 149)
- ④ Sets the airflow
- ⑤ Switches climate control on/off (→ page 148)
Switches residual heat on/off (→ page 151)
- ⑥ Sets the air distribution, right
- ⑦ Sets the temperature, right

Operating the climate control system

Switching climate control on/off

- ▶ **To switch on:** set the airflow to level 1 or higher using the button.
- ▶ **To switch off:** set the airflow to level 0 using the button.

If climate control is switched off, the windows may fog up more quickly. Switch climate control off only briefly.

Switching the climate control in the rear passenger compartment on/off

- ▶ Press button ⑤.
- ⓘ When climate control in the second seat row is switched off, the indicator lamp is activated and **OFF** is shown on the rear display.

Switching the A/C function on/off using the air conditioning control panel

The A/C function heats, cools and dehumidifies the vehicle's interior air.

- ▶ Press the button.

Switch off the A/C function only briefly; otherwise, the windows may fog up more quickly. Condensation may drip from the underside of the vehicle when cooling mode is active. This is not indicative of a malfunction.

Calling up the air conditioning menu via the climate bar or the air conditioning control panel

The air conditioning menu can be called up via the climate bar. The climate bar is always shown on the lower edge of the media display.



- ▶ Select the **Climate Menu** entry in the air conditioning bar.

Defrosting the windshield via the climate bar

Switching on

- ▶ Press on the climate bar on the central display.

Switching off

▶ Press , **AUTO** or  on the climate bar on the central display.

or

▶ Set the airflow to 0.

ⓘ When the defrost function is activated, some functions (e.g. the temperature setting) will automatically be deactivated.

Activating/deactivating the A/C function via the air-conditioning menu

Multimedia system:

➔ Climate Menu ➔ First Row of Seats

Depending on the external conditions, support for improved cooling and dehumidification of the interior air will be provided when the A/C function is activated. If it is not possible to operate the A/C function on the climate bar on the central display, switch the function on or off in the climate menu of the central display.

▶ Select **A/C** (A/C).

Setting climate control to automatic

In automatic mode, the set temperature is controlled and maintained at a constant level by the air supply.

▶ Press button **AUTO**.

▶ **To switch to manual mode:** press the **AUTO** button.

In automatic mode, you can choose between five different air quantities using the  button. Automatic mode is retained.

Automatically controlling the climate control in the rear passenger compartment

In automatic mode, the set temperature is regulated by the temperature of the dispensed air and the airflow.

▶ Press button  **AUTO** .

Setting air distribution using the air conditioning menu

Multimedia system:

➔ Climate Menu

▶ Select **First Row of Seats** or **Second Row of Seats**.

▶ To set air distribution: select ,  or .

▶ Set the airflow.

ⓘ When the air conditioning system is switched on, at least one zone is always active. However, several air distribution options can be selected at the same time, for example to set the climate control for the vehicle interior and the footwells simultaneously. The  climate control for the windshield can only be selected for the first seat row. When automatic mode is active, the buttons for setting the air distribution are automatically deactivated. When the air conditioning system is switched off, the buttons remain operable and the last setting is saved.

Setting rear climate control using the air conditioning menu

Multimedia system:

↳ Climate Menu

Setting the temperature



▶ Set the temperature.

Setting the airflow

▶ Set the airflow.

Controlling the rear climate control automatically

▶ Select **AUTO**.

- ⓘ When the defrost function is activated, some functions (e.g. the temperature setting) will automatically be deactivated. To deactivate the defrost function, press either  or  or  set the air flow to level 0 (→ page 148).

Switching the synchronization function on/off via the air-conditioning control panel

Requirements

- The vehicle is not equipped with a stationary heater.

Climate control can be set centrally using the synchronization function. The temperature and air distribution setting for the driver's side will be adopted automatically for all climate control zones.

▶ Press button **SYNC**.

The synchronization function will switch off if the settings for one of the other climate zones are changed.

Switching the synchronization function on/off via the air-conditioning menu

Multimedia system:

↳ Climate Menu ▶▶ First Row of Seats

The synchronization function controls the climate control centrally. The driver's settings for temper-

ature, airflow and air distribution are automatically adopted for each climate zone.

▶ Select **SYNC** (SYNC).

Defrosting the windows

Windows fogged up on the inside

- ▶ Press the **AUTO** button.
- ▶ If the windows remain fogged up: press the  button.

Windows fogged up on the outside

- ▶ Switch on the windshield wipers.
- ▶ Press the **AUTO** button.

Switching air-recirculation mode on/off

- ▶ Press the  button.
The interior air will be recirculated.

Air-recirculation mode automatically switches to fresh air mode after a while.

- i** If air-recirculation mode is switched on, the windows may fog up more quickly. Switch on air-recirculation mode only briefly.

Switching residual heat on/off

Requirements

- The vehicle is parked.

It is possible to make use of the residual heat from the engine to continue heating or ventilating the front compartment of the vehicle for approximately 30 minutes, depending on the temperature set.

To activate: press button  .

Residual heat will be switched off automatically.

Switching residual heat in the rear passenger compartment on/off

Requirements:

- The vehicle is parked.

When residual engine heat is activated in the rear compartment, you can heat or ventilate the rear compartment for approximately 30 minutes.

To activate: Press button **i** (→ page 148).

Activating/deactivating ionization

Multimedia system:

Climate Menu **» Air Quality**

When ionization is activated, the air in the vehicle interior is enriched with negatively charged oxygen ions. These can promote the well-being of the vehicle occupants.

To activate: Select **Ionization**.

- i** The function can be performed only if AUTO mode is activated or the air distribution is set to the side air vent. The function will be restricted if the side air vents on the driver's side are closed.

Fragrance system

Activating/deactivating the fragrance system using the multimedia system

Requirements

- Automatic climate control is activated.
- The glove compartment is closed.
- A flacon is inserted.

Multimedia system:

Climate Menu **» Air Quality**

The fragrance system distributes a pleasant fragrance throughout the vehicle interior from a flacon located in the glove compartment.

- Navigate down until the climate control bar is active.
- Select **Fragrance**.
- Activate or deactivate fragrancing.

Setting the fragrance system using the multimedia system

Requirements

- A flacon is inserted.

- The glove compartment is closed.
- Climate control is activated.

Multimedia system:

→ [Climate Menu](#) → [Air Quality](#)

The fragrance system distributes a pleasant fragrance throughout the vehicle interior from a flacon located in the glove compartment.

- ▶ Select [Fragrance](#).
- ▶ Keep pressing until the desired intensity is reached.

Inserting/removing the flacon of the fragrance system

⚠ WARNING Risk of injury from liquid perfume

If children open the flacon, they could drink the liquid perfume or it could come into contact with their eyes.

- ▶ Do not leave children unattended in the vehicle.

- ▶ Consult a doctor immediately if liquid perfume has been drunk.
- ▶ If liquid perfume comes into contact with your eyes or skin, rinse your eyes with clean water.
- ▶ If symptoms continue, consult a doctor.

🔥 ENVIRONMENTAL NOTE Environmental damage due to improper disposal of full flacons



Full flacons must not be disposed of together with household waste.



Hand in full flacons at a pollutant collection point.

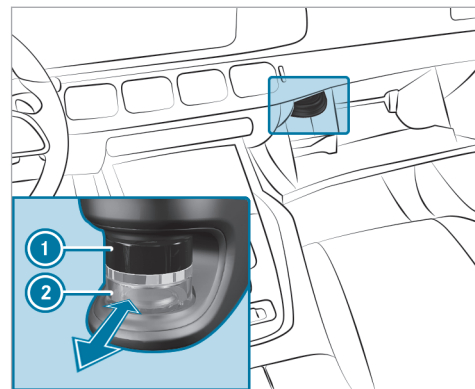

- 1 Cap
- 2 Flacon

- ▶ **To insert:** slide the flacon into the holder as far as it will go.
- ▶ **To remove:** After opening the glove compartment, wait for approximately seven seconds and pull out the flacon.

If you do not use genuine Mercedes-Benz interior perfumes, observe the manufacturers' safety notes on the fragrance packaging.

Dispose of the genuine Mercedes-Benz interior fragrance flacon when it is empty and do not refill it.

Refillable flacon

- ▶ Unscrew the cap of the empty flacon.
- ▶ Fill the flacon with a maximum of 0.5 fl. oz. (15 ml).
- ▶ Screw the cap back onto the flacon.

Always refill the empty refillable flacon with the same fragrance. Observe the separate information sheet attached to the flacon.

Air vents

Adjusting the front air vents

⚠ WARNING Risk of burns or frostbite due to being too close to the air vents

Very hot or very cold air can flow from the air vents.

- ▶ Make sure that all vehicle occupants always maintain a sufficient distance from the air vents.
- ▶ If necessary, direct the airflow to another area of the vehicle interior.

To guarantee the flow of fresh air through the air vents into the vehicle interior, note the following:

- Always keep the vents and ventilation grilles in the vehicle interior clear.
- Keep the air inlet free of residue build-up (→ page 338).
- Optimum climate comfort is achieved with the air vents in the center position.

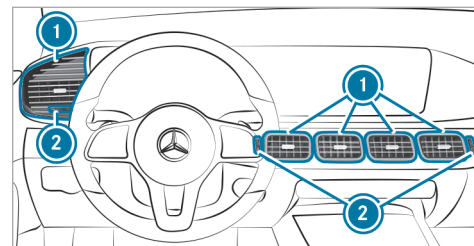

- ▶ **To open or close center air vents:** turn controller ② up or down as far as it will go.
- ▶ **To open or close side air vents:** turn controller ② to the left or right as far as it will go.
- ▶ **To adjust the air direction:** hold air vent ① in the center and move it up or down or to the left or right.

Adjusting the rear air vents

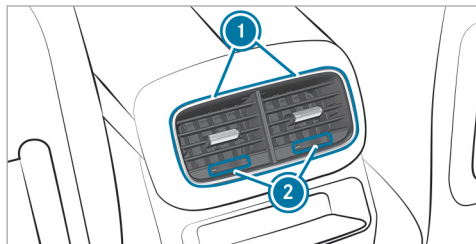

- ▶ **To open or close:** turn controller ② to the left or right as far as it will go.
- ▶ **To set the airflow direction:** hold the center of air vent ① and move it up or down or to the left or right.

Opening or closing the air vent in the glove box

! **NOTE** Damage to temperature-sensitive objects in the glove box

The air vent in the glove box may damage temperature-sensitive objects stored there.

▶ Do not store objects that are sensitive to heat or cold in the glove box.

The automatic climate control must be switched on to cool the glove box.

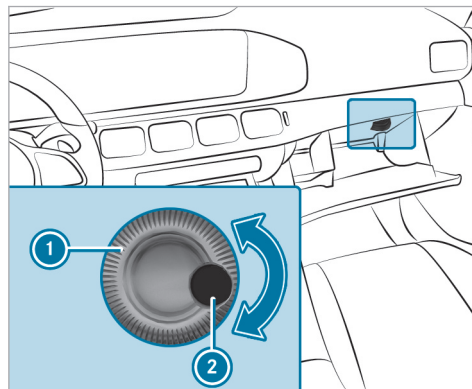

- ▶ **To open or close:** turn controller ① of air vent ② clockwise or counter-clockwise.

Driving

Notes on Mercedes-AMG vehicles

Observe the notes on the following topics in the supplement, otherwise you may fail to recognize potential dangers.

- ① Availability of some functions depends on the respective equipment and model.
- Reduction of engine output and engine torque
- AMG Real Performance Sound
- AMG ceramic high-performance composite brake system
- AMG RIDE CONTROL +
- AMG ACTIVE RIDE CONTROL
- AMG steering wheel buttons

Switching on the power supply or the vehicle

⚠ WARNING Risk of accident and injury due to children left unattended in the vehicle

If you leave children unattended in the vehicle, they could, in particular:

- open doors, thereby endangering other persons or road users.
- get out and be struck by oncoming traffic.
- operate vehicle equipment and become trapped, for example.

In addition, the children could also set the vehicle in motion by, for example:

- releasing the parking brake.
- changing the gearbox position.
- starting the vehicle.

- ▶ Never leave children unattended in the vehicle.
- ▶ When leaving the vehicle, always take the key with you and lock the vehicle.
- ▶ Keep the key out of reach of children.

Requirements:

- The key is in the vehicle and is detected.
- The brake pedal is not depressed.

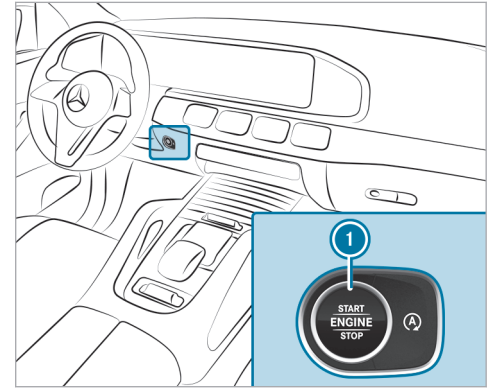

- ▶ **To switch on the power supply:** press button ① once.
You can e.g. switch on the windshield wiper.

The power supply will be switched off again if the following conditions are met:

- You open the driver's door.
- You press button **1** twice more.

▶ **To switch on the vehicle:** press button **1** twice.
Indicator and warning lamps will light up on the driver display.

The vehicle will be switched off again if one of the following conditions is met:

- You do not start the vehicle within 15 minutes and the transmission is in position **P** or the electric parking brake is applied.
- You press button **1** once.

Starting the vehicle

Starting the vehicle with the start/stop button

⚠ DANGER Risk of death caused by exhaust gases

Combustion engines emit poisonous exhaust gases such as carbon monoxide. Inhaling these exhaust gases is hazardous to health and leads to poisoning.

- ▶ Never leave the engine or, if present, the auxiliary heating running in an enclosed space without sufficient ventilation.

⚠ WARNING Risk of fire due to flammable materials in the engine compartment or on the exhaust system

Flammable materials may ignite.

- ▶ Therefore, regularly check that there are no flammable foreign materials in the engine compartment or on the exhaust system.

Requirements:

- The key is in the vehicle and is detected.
- ▶ Shift the transmission to position **P** or **N**.
- ▶ Depress the brake pedal and press button **1** once.
- ▶ If the vehicle does not start: switch off non-essential electrical consumers and press button **1** once.
- ▶ If the vehicle still does not start and the **Place the Key in the Marked Space See Operator's Manual** display message appears on the driver display: start the vehicle with the key in the marked space (emergency operation mode) (→ page 157).
- ⓘ You can switch off the vehicle while driving. To do this, press and hold button **1** for about three seconds or press button **1** three times within three seconds. Be sure to observe the safety notes concerning this under "Driving tips" (→ page 160).

Observe any information regarding display messages that may be shown on the driver display.

Starting the vehicle with the key in the storage compartment (emergency operation mode)

If the vehicle does not start and the **Place the Key in the Marked Space See Operator's Manual** message appears on the driver display, you can start the vehicle in emergency mode.

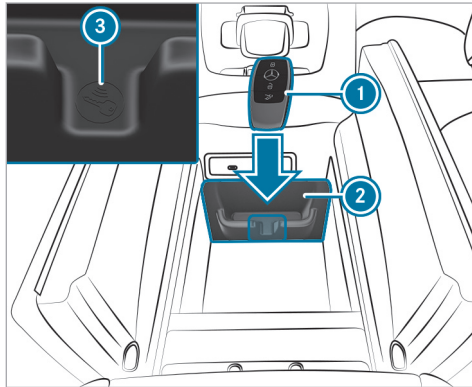

- ▶ Make sure that the storage compartment ② is empty.

- ▶ Remove key ① from the key ring.
- ▶ Place the key ① in the storage compartment ② next to symbol ③. The vehicle will start after a short time. If you remove the key ① from the storage compartment ②, it will still be possible to continue driving the vehicle. For further engine starts, however, key ① must be located in the storage compartment ② next to symbol ③ during the entire journey.
- ▶ Have key ① checked at a qualified specialist workshop.

If the vehicle does not start:

- ▶ Place the key ① in the storage compartment ② and leave it there.
- ▶ Depress the brake pedal and start the vehicle using the start/stop button.
- ⓘ You can switch on the power supply or the vehicle with the start/stop button (→ page 155).

Observe any information regarding display messages that may be shown on the driver display.

Starting the vehicle via Remote Online Services

Cooling or heating the vehicle interior before a drive

Ensure the following before starting the engine:

- The legal stipulations in the area where your vehicle is parked allow engine starting via smartphone.
- It is safe to start and run the engine where your vehicle is parked.
- The fuel tank is sufficiently full.
- The starter battery is sufficiently charged.

Charging the starter battery before a drive

You can receive a message on your smartphone when the state of charge of the starter battery is low. You can then start the vehicle with the smartphone to charge the battery. The vehicle will automatically be turned off after ten minutes.

Ensure the following before starting the engine:

- The legal stipulations in the area where your vehicle is parked allow engine starting via smartphone.

- It is safe to start and run the engine where your vehicle is parked.
- The fuel tank is sufficiently full.

Starting the vehicle (Remote Online)

⚠ WARNING Risk of crushing or entrapment due to unintentional starting of the engine

Limbs could be crushed or trapped if the engine is started unintentionally during service or maintenance work.

- ▶ Always secure the engine against unintentional starting before carrying out maintenance or repair work.

Requirements

- Park position **P** is selected.
- The anti-theft alarm system is not activated.
- The panic alarm is not activated.
- The hazard warning lights are off.
- The hood is closed.
- The doors are closed and locked.
- The windows and sliding sunroof are closed.

- ▶ Start the vehicle using the smartphone. After every vehicle start, the engine runs for ten minutes.

You can carry out a maximum of two consecutive starting attempts. You must start the vehicle once with the key before starting the vehicle again with the smartphone.

You can turn off the vehicle at any time as follows:

- via the Mercedes me App
 - by pushing the button **⏻** or **⏻** on the key
- i** Further information can be found in the Mercedes me App.

Securing the engine against starting before carrying out maintenance or repair work:

- ▶ Turn on the hazard warning lights or unlock the doors.
- ▶ Open a side window or the sliding sunroof.

Breaking-in notes

To preserve the engine during the first 1000 miles (1500 km):

- Drive at varying road speeds and engine speeds.
- Do not drive faster than 85 mph (140 km/h).
- Drive the vehicle in drive program **C** or **E**.
- Then shift to the next higher gear at the very latest when the needle reaches the last third before the red area in the tachometer.
- Do not shift down manually in order to brake.
- Avoid overstraining the vehicle, e.g. by driving at full throttle.
- Do not depress the accelerator pedal past the pressure point (kickdown).
- Increase the engine speed only gradually and accelerate the vehicle to full speed after 1000 miles (1500 km).

This also applies when the engine or parts of the drivetrain have been replaced.

Please also observe the following breaking-in notes:

- In certain handling and driving safety systems, the sensors adjust automatically while a certain distance is being driven after the vehicle has been delivered or after repairs. Full system effectiveness is reached only when this teaching-in process has concluded.
- Brake pads, brake discs and tires that are either new or have been replaced achieve optimum braking effect and grip only after the vehicle has been driven several hundred kilometers. Compensate for the reduced braking effect by applying greater force to the brake pedal.

Notes on optimize acceleration

If all necessary requirements and activation conditions are fulfilled, the best possible acceleration can be achieved from a standstill.

Do not use optimize acceleration on public roads. Individual wheels could spin and you could lose

control of the vehicle. There is an increased risk of skidding and/or accident.

Be sure to observe the safety notes and information on ESP® (→ page 194).

Pulling away with optimized acceleration

⚠ WARNING Risk of skidding and accidents due to the wheels spinning

If you pull away using optimized acceleration, individual wheels can spin and the vehicle can skid.

There is an increased risk of skidding and accidents, especially when ESP® is switched off!

▶ Make sure that there are no persons or obstacles in the vicinity of the vehicle.

Requirements

- The vehicle is broken in (→ page 158).
- The vehicle and tires are in good condition.
- The road surface offers good grip.

- The engine and transmission are at normal operating temperature.

! **NOTE** Increased wear due to optimized acceleration

When pulling away with optimized acceleration, all components of the drivetrain are subjected to a very high load.

This can lead to increased component wear.

▶ Do not always pull away with optimized acceleration.

- ▶ Engage the **[D]** drive position (→ page 176).
- ▶ Move the steering wheel to the straight-ahead position.
- ▶ Select drive program **[S]** (→ page 172).
- ▶ Deactivate ESP® (→ page 195).
- ▶ Depress and hold the brake pedal firmly with your left foot.
- ▶ Fully depress the accelerator pedal with your right foot.

- ▶ After no more than five seconds, quickly take your left foot off the brake, but keep the accelerator pedal depressed. The vehicle will pull away at maximum acceleration.
- ▶ Switch on ESP® once the acceleration procedure is complete.

Ending optimized acceleration

- ▶ Remove your foot from the accelerator pedal.
- ▶ Reactivate ESP®.
- ⓘ After you pull away with optimized acceleration, components of the drivetrain may be very hot, which means that optimized acceleration values may possibly only be achieved again after a few minutes.

Notes on driving

⚠ WARNING Risk of accident due to objects in the driver's footwell

Objects in the driver's footwell may impede pedal travel or block a depressed pedal.

This will jeopardize the operating- and road safety of the vehicle.

- ▶ Stow all objects in the vehicle securely so that they cannot get into the driver's footwell.
- ▶ Make sure that there is always sufficient clearance for the pedals.
- ▶ Always install the floor mats securely and as prescribed.
- ▶ Do not use loose floor mats and do not place floor mats on top of one another.

⚠ WARNING Risk of accident due to incorrect footwear

Incorrect footwear includes, for example:

- Shoes with platform soles
- Shoes with high heels
- Slippers

There is a risk of an accident.

- ▶ Always wear suitable footwear so that you can operate the pedals safely.

⚠ WARNING Risk of accident if the vehicle is switched off while driving

If you switch off the vehicle while driving, safety functions are restricted or no longer available.

This may affect the power steering system and the brake force boosting, for example.

You will need to use considerably more force to steer and brake, for example.

- ▶ Do not switch off the vehicle while driving.

⚠ DANGER Risk of death caused by exhaust gases

Combustion engines emit poisonous exhaust gases such as carbon monoxide. Inhaling these exhaust gases is hazardous to health and leads to poisoning.

- ▶ Never leave the engine or, if present, the auxiliary heating running in an enclosed space without sufficient ventilation.

⚠ WARNING Risk of skidding and of an accident due to shifting down on slippery road surfaces

If you shift down on slippery road surfaces to increase the engine braking effect, the drive wheels may lose traction.

- ▶ Do not shift down on slippery road surfaces to increase the engine braking effect.

⚠ DANGER Risk of fatal injury due to poisonous exhaust gases

If the tailpipe is blocked or sufficient ventilation is not possible, poisonous exhaust gases such as carbon monoxide may enter the vehicle. This is the case, for example, if the vehicle gets stuck in the snow.

- ▶ Keep the tailpipe and the area around the vehicle free from snow when the engine or the stationary heater is running.

- ▶ Open a window on the side of the vehicle facing away from the wind to ensure an adequate supply of fresh air.

⚠ WARNING Risk of accident and injury due to being under the influence of alcohol and drugs while driving

Drinking and driving and/or taking drugs and driving are very dangerous combinations. Even a small amount of alcohol or drugs can affect your reflexes, perceptions and judgment.

The possibility of a serious or even fatal accident are greatly increased when you drink or take drugs and drive.

- ▶ Do not drink or take drugs and drive or allow anyone to drive who has been drinking or taking drugs.

⚠ WARNING Risk of accident due to the brake system overheating

If you leave your foot on the brake pedal when driving, the brake system may overheat.

This increases the braking distance and the brake system can even fail.

- ▶ Never use the brake pedal as a footrest.
- ▶ Do not depress the brake pedal and the accelerator pedal at the same time while driving.

! NOTE Engine damage due to excessive engine speed

You will damage the engine if you drive at excessive engine speeds.

- ▶ Do not drive at engine speeds in the red area of the tachometer, or shown in red in the driver display.

! NOTE Wearing out the brake linings by continuously depressing the brake pedal

- ▶ Do not depress the brake pedal continuously whilst driving.
- ▶ To use the braking effect of the engine, shift to a lower gear in good time.

! **NOTE** Damage to the drivetrain and engine when pulling away

- ▶ Do not warm up the engine while the vehicle is stationary. Pull away immediately.
- ▶ Avoid high engine speeds and driving at full throttle until the engine has reached its operating temperature.

! **NOTE** Damage to the catalytic converter due to non-combusted fuel

The engine is not running smoothly and is misfiring.

Non-combusted fuel may get into the catalytic converter.

- ▶ Only depress the accelerator pedal slightly.
- ▶ Have the cause rectified immediately at a qualified specialist workshop.

! **NOTE** Reduced battery life due to frequent short-distance trips

The 12 V battery may not be sufficiently charged when the vehicle is used only for short-distance trips. This reduces the life of the battery.

- ▶ Drive longer distances regularly to charge the battery.

! **NOTE** Vehicle damage due to failure to observe the maximum permissible clearance height

If the vehicle height exceeds the maximum permissible clearance height, the roof and other vehicle parts may be damaged.

- ▶ Please observe the maximum clearance height indicated.
- ▶ If the vehicle exceeds the permissible clearance height, do not drive in.
- ▶ Take the modified vehicle height into account in the case of roof superstructures or other carrier systems.

i Please bear in mind that all speed values stated in this Operator's Manual are approximate and are subject to a certain tolerance.

Observe the notes on driving with a roof load, trailer or fully laden vehicle.

Driving with a loaded roof luggage rack or trailer, or with the vehicle fully laden or occupied, changes the handling and steering characteristics of your vehicle.

Therefore please observe the following notes:

- Do not exceed the permissible roof load and trailer load. Also observe the information in the technical data in this respect.
- Distribute the roof load and vehicle load evenly, and place heavy objects at the bottom. Also comply with the notes on loading the vehicle (→ page 113).
- Drive carefully, avoiding abrupt starting, braking and steering as well as fast cornering.
- If trailer operation is permitted, observe the notes on trailer operation (→ page 266).

Notes on driving on roads treated with de-icing salt

The braking effect is limited on road surfaces treated with de-icing salt.

Please therefore bear in mind the following notes:

- Due to salt build-up on the brake discs and brake linings, the braking distance can increase considerably or braking may be one-sided.
- Maintain a much greater safety distance to the vehicle traveling ahead.

Remove salt build-up as follows:

- Brake occasionally, paying attention to the traffic conditions
- Carefully depress the brake pedal at the end of the journey and when starting the next journey

Notes on hydroplaning

Hydroplaning can take place if a certain depth of water has built up on the road surface.

Observe the following notes during heavy precipitation or in conditions in which hydroplaning may occur:

- Reduce speed.
- Avoid tire ruts.
- Avoid sudden steering movements.
- Brake carefully.

 Also observe the notes on regularly checking wheels and tires (→ page 370).

Notes on driving through water on the road

Water ingress can damage the engine, electrics and transmission.

Water can also enter the air intake of the engine and cause engine damage.

Observe the following if you need to drive through water:

- Observe the maximum permissible fording depth (→ page 416).
- Drive at a walking pace at most, otherwise water may enter the vehicle interior or engine compartment.

- Vehicles traveling ahead, or oncoming vehicles, may create waves that cause the water to exceed the maximum permissible depth.

Braking performance will be reduced after fording. Brake carefully while paying attention to the traffic conditions until braking performance has been fully restored.

Notes on off-road driving

 **WARNING** Risk of accident if you do not keep to line of fall on inclines

If you drive at an angle or turn on an incline, the vehicle could slip sideways, tip and roll-over.

 Always drive on inclines in the line of fall (straight up or down) and do not turn.

⚠ WARNING Risk of fire caused by flammable material on hot exhaust system components

Flammable material such as leaves, grass or twigs may ignite if they come into contact with hot parts of the exhaust system.

- ▶ When driving on an unpaved road or off-road, check the vehicle underside regularly.
- ▶ In particular, remove trapped plant parts or other flammable material.
- ▶ If there is damage, consult a qualified specialist workshop immediately.

When driving off-road, it is possible that e.g. sand, mud and water, or water mixed with oil, may get into the brakes. This may lead to a reduction in braking effect or brake failure, also as a result of increased wear. The braking characteristics will vary depending on the material that has entered the system. Clean the brakes after driving off-road. If you then notice reduced braking effect or hear scraping noises, have the brake system checked at a qualified specialist workshop. Adapt

your driving style to the modified braking characteristics.

! NOTE Damage caused by driving over obstacles

The vehicle can be damaged by:

- bottoming out on high curbs or on unpaved trails
 - driving at speed over obstacles such as curbs, speed bumps or potholes
 - heavy objects impacting the underbody or suspension components
- ▶ Do not drive over obstacles that might damage the vehicle.
 - ▶ When driving off-road, regularly check the vehicle for damage.
 - ▶ Adjust your speed to the road conditions.
 - ▶ In the event of damage, immediately consult a qualified specialist workshop.

🔥 ENVIRONMENTAL NOTE Environmental damage due to non-observance of prohibition signs

Environmental protection has priority. Treat nature with respect.

- ▶ Be sure to observe prohibition signs.

i The vehicle is designed for easily negotiable and moderate terrain. When driving off-road, make sure there is sufficient ground clearance.

Checklist before driving off-road

Check the following points before driving off-road:

- Fuel level
- Engine oil level: fill engine oil to the maximum level to ensure full gradeability (→ page 334).
- Tire-change tool kit and spare wheel if provided
- Tires and wheels

- ① Further information about special all-terrain tires for retrofitting can be obtained from a qualified specialist workshop.

The off-road menu in the multimedia system can assist you when driving off-road. Before driving off-road, familiarize yourself with its displays and equipment-dependent settings (→ page 295).

Off-road driving

Read this section before driving your vehicle off-road. Practice by driving in less challenging terrain first.

- Observe the notes on off-road ABS (→ page 193).
- Select the  (→ page 172) drive program before driving off-road.
- Select a vehicle level appropriate for the terrain (→ page 234). To avoid damage to the vehicle, always ensure adequate ground clearance.
- Always keep the engine running and in gear when driving on downhill gradients and slopes. Observe the notes on driving in mountainous terrain.

- Do not drive in unknown terrain that is not easy to see and stay on marked routes.
- Always keep the doors and windows closed while the vehicle is in motion.
- Deactivate Active Distance Assist DISTRONIC or the cruise control.
- Adapt your driving style to the terrain.
- Do not use the HOLD function on steep downhill or uphill gradients with slippery or loose surfaces.

Driving on sand

When driving on sand, also observe the following instructions:

- Select the  drive program.
- Select a higher vehicle level.
- Shift to a lower gear.
- Drive briskly to overcome the rolling resistance. The vehicle may otherwise dig itself in.
- Drive in the tracks of other vehicles if possible. Make sure that the following prerequisites are met:

- the tire ruts are not too deep.
- the sand is firm enough.
- the ground clearance is sufficient.

Fording

Also observe the following information when fording:

- **Vehicles with AIRMATIC:** set the highest possible vehicle level (→ page 234).
- **Vehicles with E-ACTIVE BODY CONTROL:** set the highest possible vehicle level (→ page 241).
- Drive no faster than walking pace, if necessary max. 6 mph (10 km/h).
- Observe the maximum permissible fording depth (→ page 416).
- Switch off automatic climate control (→ page 149).
- Ensure that a bow wave does not form as you drive.
- Do not stop in the water and do not switch off the engine. Ensure the ECO start/stop function is switched off (→ page 167).

Driving in mountainous terrain

Also observe the following information when driving in mountainous terrain:

- Observe the figures for the angle of approach/departure and of the maximum gradeability (→ page 416).
- Avoid high engine speeds.
- Use the braking power of the engine when driving downhill.
- Shift to a lower gear on uphill gradients and on long, steep downhill gradients.
- If necessary, activate DSR before driving downhill (→ page 209).

Checklist after driving off-road

Driving off-road places greater demands on your vehicle than driving on normal roads. Check the entire vehicle underbody for damage and foreign bodies every time after driving off-road. Foreign bodies in the wheels or drivetrain can lead to imbalances and therefore vibrations.

- If the  drive program is selected: select another drive program.

- Deactivate DSR.
- Lower the vehicle to a level suitable for the road conditions, e.g. normal level.
- Apply the brakes to dry them after fording.
- Check that the service brake is working normally after a long downhill stretch.
- Clean the following component parts every time after driving off-road:
 - license plate
 - headlamps and tail lamps
 - tires, wheels and wheel arches
 - underbody
- After driving through sand, mud, water or gravel, have the following component parts checked and cleaned:
 - brake discs and brake linings
 - tires and wheels
 - axle joints

ECO start/stop function

ECO start/stop function

- ❗ Depending on the engine, the ECO start/stop function is not available in all drive programs. Observe the status display on the driver display concerning this.

The engine will be switched off automatically in the following situations if all vehicle conditions for an automatic engine stop are met:

- You brake the vehicle to a standstill in transmission position **D** or **N**.
- You depress the brake pedal when traveling at a low speed.

If the system has detected one of the following situations, the engine will not stop:

- You stop at a stop sign and there is no vehicle in front of you.
- The vehicle that stopped in front of you pulls away again.
- You maneuver, turn the steering wheel sharply or engage reverse gear.





This prevents the engine from stopping briefly.

- ❶ If the system detects a stop inhibitor to prevent a short stop, e.g. a stop sign, the engine will not stop.
If you activate the HOLD function or engage park position **P**, the engine can be switched off in spite of such a stop inhibitor.

The engine will restart automatically in the following cases:

- You engage transmission position **D** or **R**.
- You step on the accelerator pedal.
- The vehicle requires an automatic engine start.
- You release the brake pedal.
- You release the brake pedal on a downhill gradient and the vehicle does not roll.
- The vehicle rolls on a downhill gradient and does not automatically enter glide mode at 15 mph (20 km/h).

ECO start/stop function symbols on the driver display:

- The  symbol (green) appears when the vehicle is at a standstill: the engine was switched off by the ECO start/stop function.
- The  symbol (yellow) appears when the vehicle is at a standstill: not all vehicle conditions for an engine stop have been met.
- Neither the  nor the  symbol appears when the vehicle is at a standstill: a stop inhibitor to prevent a short stop has been detected, e.g. a stop sign.
- The  symbol appears: the ECO start/stop function is deactivated or there is a malfunction.

If the engine was switched off by the ECO start/stop function and you leave the vehicle, a warning tone will sound and the engine will not be restarted. In addition, the following display message will appear on the driver display:

Vehicle is Ready to Drive Switch Off Vehicle Before Exiting

If you do not switch off the vehicle, it will automatically be switched off after three minutes.

Switching the ECO start/stop function on/off

! NOTE Mercedes-AMG vehicles

- ▶ Observe the notes in the Supplement. You could otherwise fail to recognize dangers.

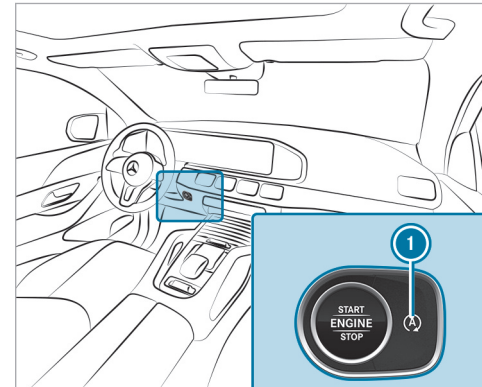

▶ Press button ❶.

A symbol will appear on the driver display when you switch the ECO start/stop function on/off.

❶  will be shown permanently on the driver display while the ECO start/stop function is deactivated.

ECO display function

❶ Depending on the model and equipment, your vehicle will have one of the following representations of the ECO display.

The ECO display summarizes your driving characteristics from the start of the journey to its completion and assists you in achieving the most economical driving style.

The ECO display assesses the following criteria for an economical driving style:

- Coasting at the right times
- Consistent speed
- Moderate acceleration

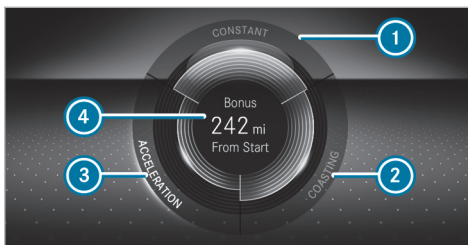

The lettering in the segment will light up brightly, the outer edge will light up and the segment will fill up when the following driving style is adopted:

- ❶ Steady speed
- ❷ Gentle deceleration and rolling
- ❸ Moderate acceleration

The lettering in the segment will be gray, the outer edge will be dark and the segment will empty when the following driving style is adopted:

- ❶ Fluctuations in speed
- ❷ Heavy braking
- ❸ Sparty acceleration

The ECO display will show you when you have driven economically:

- The three segments will fill up completely at the same time
- The edge around all three segments will light up

The additional range achieved as a result of your driving style in comparison with a driver with a very sporty driving style will be shown in the center of the display ❷. The range displayed does not indicate a fixed reduction in consumption.

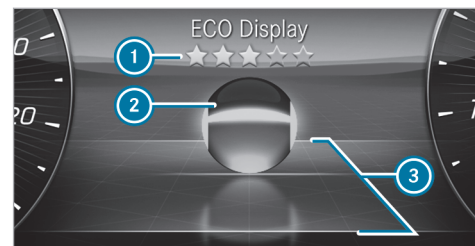

The ECO display shows an evaluation of your driving style on the driver display depending on the

situation. This enables you to check the efficiency of your driving style and adjust it if necessary. The **ECO Display** menu shows a ball ② that will roll forwards or backwards in the direction of travel on a stylized road according to the driving characteristics.

Above and below the road, lines mark the area for an efficient driving style ③. Ball ② will light up in green if it is rolling within these lines. Outside the lines, the ball will light up in orange.

The overall assessment of your driving style "from start" is indicated using stars ①. It starts with five empty stars, which you can fill one after the other if you drive efficiently. When all five stars are filled, a glow will appear in the background.

- ① You can call up the **ECO Display** function via the **Classic** menu (→ page 274).

ECO Assist function (vehicles with 48 V on-board electrical system)

- ① ECO Assist is active only in drive programs **[E]** and **[C]**.

ECO Assist analyzes data for the vehicle's expected route. This allows the system to optimally adjust the driving style for the route ahead, save fuel and recuperate. If the system detects an event ahead and the vehicle nears the event, ECO Assist will calculate the optimum speed for maximum fuel economy and recuperative energy based on the distance, speed and downhill gradient.

If the deceleration provided by ECO Assist is not sufficient, you must also brake with the service brake. This is especially the case if, for example, you pull away again in slow-moving traffic and the distance to the vehicle in front is very short.

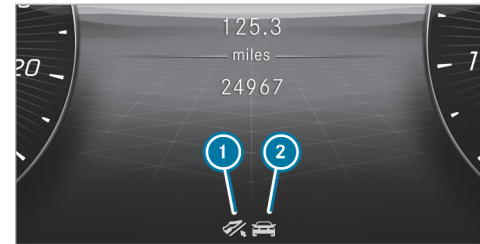



- ① "Foot off the accelerator" recommendation
- ② Route event ahead





If a route event ahead or a vehicle driving in front is detected which requires an adjustment to your driving style to ensure greater efficiency, corresponding symbol ② and the  symbol will be displayed in gray.





If you release the accelerator pedal, the  symbol will turn green and recuperation in over-run mode will be initiated. If the deceleration is not sufficient, also apply the service brake. If ECO Assist intervenes for a route event ahead (not for a vehicle in front) and you then press the accelerator pedal again, you end ECO Assist's control.

The ECO Assist display is hidden again in the following cases:

- You do not react to the ECO Assist recommendation for a long time.
- You press the accelerator pedal while ECO Assist is intervening for a route event ahead (not for a vehicle in front).
- ECO Assist cannot identify any further recommendations from the route ahead.

Depending on the equipment, in addition to the  vehicle driving ahead, ECO Assist detects following route events :

-  Traffic circle
-  T-intersection
-  Downhill gradient
-  Speed limit

-  In the  drive program, ECO Assist only reacts to the route event "Vehicle in front" without a display of the  route event and the  recommendation.

System limits

If the calculated route is adhered to when route guidance is active, ECO Assist will operate with greater accuracy. The basic function is also available without active route guidance. Not all information and traffic situations can be foreseen. The quality depends on the map data.

ECO Assist is only an aid. The driver is responsible for keeping a safe distance from the vehicle in front, for vehicle speed and for braking in good time.

The system may be impaired or may not function in the following situations:

- If there is poor visibility, e.g. due to insufficient illumination of the road, highly variable shade conditions, rain, snow, fog or heavy spray.
- If there is glare, e.g. from oncoming traffic, direct sunlight or reflections.
- If the windshield is dirty in the vicinity of the multifunction camera.
- If the multifunction camera is fogged up, damaged or obscured.

- If road signs are hard to detect, e.g. due to dirt, snow or insufficient lighting, or because they are obscured.
- If the information in the navigation system's digital map is incorrect or out of date.
- If signs are ambiguous, e.g. road signs in roadworks or in adjacent lanes.
- If the radar sensors are dirty or obscured.
- When you drive on roads with steep uphill or downhill gradients.
- If there are narrow vehicles in front, such as bicycles or motorcycles.

DYNAMIC SELECT

Function of DYNAMIC SELECT

NOTE Mercedes-AMG vehicles

-  Observe the notes in the Supplement. You could otherwise fail to recognize dangers.

DYNAMIC SELECT allows a drive program to be selected quickly according to the current driving conditions or the desired vehicle characteristics. You will be able to select the following drive programs.

 Depending on the engine line-up and equipment, the vehicle will have different drive programs.

The drive program selected will appear on the driver display.

Individual

- Custom settings (→ page 173)

Sport

- Maximum output is available
- Sporty driving
- Sporty, but with an emphasis on stability
- Enables a sporty driver to adopt a more active driving style
- Suitable only for good road conditions, a dry surface and a clear stretch of road
- **Vehicles with AIRMATIC or E-ACTIVE BODY CONTROL:** lowers the vehicle to low level -1

Comfort

- Comfortable and economical driving
- Balance between traction and stability
- Recommended for all road conditions
- **Vehicles with AIRMATIC or E-ACTIVE BODY CONTROL:**
 - Adjusts the vehicle to normal level
 - From approximately 87 mph (140 km/h): lowers the vehicle to low level -1
 - Below approximately 25 mph (40 km/h): raises the vehicle to normal level

Curve

- Available only for vehicles with E-ACTIVE BODY CONTROL
- Comfortable driving with curve tilting function
- Balance between traction and stability
- Recommended for all road conditions
- Adjusts the vehicle to normal level
- From approximately 87 mph (140 km/h): lowers the vehicle to low level -1

- Below approximately 25 mph (40 km/h): raises the vehicle to normal level

Eco

- Particularly economical driving
- Balance between traction and stability
- Recommended for all road conditions
- **Vehicles with AIRMATIC or E-ACTIVE BODY CONTROL:**
 - Adjusts the vehicle to normal level
 - From approximately 87 mph (140 km/h): lowers the vehicle to low level -1
 - Below approximately 25 mph (40 km/h): raises the vehicle to normal level

Offroad

- For driving off-road, e.g. on dirt tracks, loose surfaces, gravel or sand, as well as on difficult, uneven terrain, where there are no firm road surfaces and over rocky terrain
- Intervenes later if there is oversteer or understeer, thus improving traction
- Not suitable for use on public roads

- Can be selected up to 62 mph (100 km/h)
- From approximately 68 mph (110 km/h): switches to **C**
- **Vehicles with AIRMATIC or E-ACTIVE BODY CONTROL:**
 - Below approximately 37 mph (60 km/h): raises the vehicle to off-road level +1
 - From approximately 50 mph (80 km/h): lowers the vehicle to normal level and
 - Below approximately 30 mph (45 km/h): raises the vehicle to off-road level +1 again
 - When the system switches to **C**: lowers the vehicle to normal level

i The ESP® settings in drive programs **E** and **C** are designed for stability. Therefore, choose one of these drive programs especially when transporting roof loads, in trailer operation and when the vehicle is fully laden or fully occupied.

Depending on the drive program, the following systems will change their characteristics:

- Drive

- Engine and transmission management
- Active Distance Assist DISTRONIC
- Availability of Glide mode
- ESP®
- **Vehicles with AIRMATIC or E-ACTIVE BODY CONTROL:** suspension
 - Suspension and damping
 - Vehicle level (speed-dependent)
- Steering

Notes on the roof load display

Certain drive programs and ESP® settings are unsuitable for transporting a roof load.

If one of these drive programs is set or selected, the  symbol is shown as a warning. When this symbol is shown, the selected drive program is not suitable for transporting a load on the roof.



The following drive programs are affected:

- Drive program **S** **Sport**
- Drive program **I*** **Individual** with the ESP® setting Sport

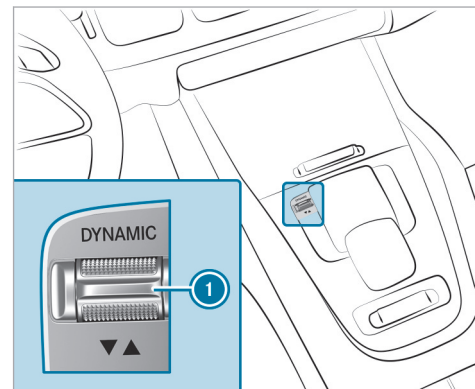
Selecting the drive program



- ▶ Push DYNAMIC SELECT switch **1** forward or backward.
The drive program selected will appear on the driver display.





-  In the  off-road program, some driving systems are subject to functional restrictions or are unavailable. When you select the  off-road program, a confirmation prompt will therefore appear on the central display before the drive program is activated.

Configuring DYNAMIC SELECT in the multimedia system

Multimedia system:

  **Settings** **Vehicle**
DYNAMIC SELECT

Setting the I drive program

-  Select  **Individual**.
-  Select .
-  Select a category from the list and set it.

-  A sporty ESP mode can be set in conjunction with a sporty suspension mode.

Switching the reset display on/off

-  Activate or deactivate **Request at Start**.

-  This function must be activated for each user profile separately. Only when this function is activated will the drive program and ECO start/stop setting for the previous journey be saved for the respective user profile.

Function on: the next time the vehicle is started a prompt appears asking whether the last active drive program should be restored. If the ECO start/stop function was deactivated, an additional prompt appears asking if the function should remain deactivated.

-  The prompt appears only if the previously active settings deviate from the standard settings.

Function off: the next time the vehicle is started the  drive program is set automatically. The ECO start/stop function is activated automatically.

Displaying vehicle data

Multimedia system:

  **Info**

-  Select **Vehicle**.
The vehicle data is displayed.

Displaying engine data

Multimedia system:

  **Info**

-  Select **Engine**.
The engine data is displayed.

-  The actual maximum values that can be achieved for engine output and engine torque may deviate from the certified values within the country-specific guidelines for permissible tolerances (basis: UN-ECE No. 85 or country-specific guidelines).

Influencing variables include:

- Sea level
- Fuel quality
- Outside temperature

- Operating temperature of the engine

Adjust your driving style accordingly.

The  warning lamp in the driver display is on until the engine has reached operating temperature.

- ① The values displayed serve only as guidance. The values for engine output and engine torque shown in the media display may deviate from the actual values.
- ① The  warning lamp to show the power output limitation after starting the vehicle is not available in all vehicle models.

Calling up the fuel consumption indicator

Multimedia system:



- ▶ Select **Consumption**.

The current and average fuel consumption will be displayed.

Automatic transmission

DIRECT SELECT lever

Function of the DIRECT SELECT lever

- ⚠ **WARNING** Risk of accident due to incorrect gearshifting

If the engine speed is higher than the idle speed and you engage the transmission position **D** or **R**, the vehicle may accelerate sharply.

- ▶ If you engage the transmission position **D** or **R** when the vehicle is at a standstill, always depress the brake pedal firmly and do not accelerate at the same time.

- ⚠ **WARNING** Risk of accident and injury due to children left unattended in the vehicle

If you leave children unattended in the vehicle, they could, in particular:

- open doors, thereby endangering other persons or road users.
- get out and be struck by oncoming traffic.
- operate vehicle equipment and become trapped, for example.

In addition, the children could also set the vehicle in motion by, for example:

- releasing the parking brake.
- changing the gearbox position.
- starting the vehicle.
- ▶ Never leave children unattended in the vehicle.
- ▶ When leaving the vehicle, always take the key with you and lock the vehicle.
- ▶ Keep the key out of reach of children.

⚠ WARNING Risk of accident- and injury when the transmission position is not engaged

The current transmission position will be highlighted on the driver display.

If the selected transmission position is not highlighted, the vehicle may pull away in the wrong direction or roll away.

▶ After changing the transmission position, always check the transmission position indicator on the driver display.

If the transmission position is not highlighted on the driver display even after a short time:

- ▶ Pay attention to the display messages.
- ▶ Pull away carefully and check the engaged transmission position.
- ▶ When parking, engage the parking brake and secure the vehicle against rolling away.
- ▶ Have the transmission checked immediately at a qualified specialist workshop.

Use the DIRECT SELECT lever to switch the transmission position. The current transmission position will be highlighted on the driver display.

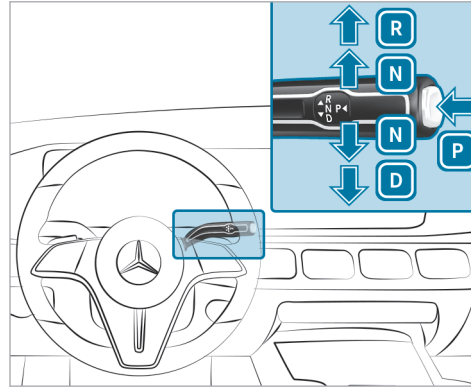

- P** Park position
- R** Reverse gear
- N** Neutral
- D** Drive position

Engaging reverse gear R

- ▶ Depress the brake pedal and push the DIRECT SELECT lever upwards past the first point of resistance.

Engaging neutral N

- ▶ Depress the brake pedal and push the DIRECT SELECT lever up or down to the first point of resistance.

- ⓘ To shift into neutral **N** with the vehicle switched on, push the selector lever up or down for several seconds to the first point of resistance.

Subsequently releasing the brake pedal will allow you to move the vehicle freely, e.g. to push it or tow it away.

Proceed as follows if you want the automatic transmission to remain in neutral **N, even if the vehicle is switched off or the driver's door is opened:**

- ▶ Depress the brake pedal and engage neutral **N** when the vehicle is at a standstill.
- ▶ Release the brake pedal.

- ▶ Switch off the vehicle.

The **Risk of Vehicle Rolling Away N Activated Manually No Automatic Change to P** message appears on the driver display.

- ⓘ If you then exit the vehicle leaving the key in the vehicle, the automatic transmission will remain in neutral **N**.

Park position **P** will automatically be re-engaged as soon as one of the following conditions is met:

- You switch to transmission position **D** or **R**.
- You press the button **P**.

■ Engaging park position P

! **NOTE** Damage due to engaging park position **P** while the vehicle is rolling

If you shift the transmission into park position **P** while the vehicle is rolling, the transmission may be damaged.

- ▶ If the vehicle is rolling, do not open a door.

- ▶ Only engage park position **P** when the vehicle is stationary.

- ▶ Observe the notes on parking the vehicle (→ page 182).
- ▶ Depress the brake pedal until the vehicle comes to a standstill.
- ▶ When the vehicle is stationary, press button **P**.
When the **P** transmission position display is shown, park position is engaged. If the **P** transmission position display is not shown, apply the parking brake and secure the vehicle to prevent it from rolling away.

- ⓘ Depending on the situation, it may take a short time until **P** is engaged. Therefore, always pay attention to the transmission position display.

Park position **P** will be engaged automatically if one of the following conditions is met:

- You switch the stationary vehicle off in transmission position **D** or **R**.

- You open the driver's door when the vehicle is stationary in transmission position **D** or **R**.
- When the vehicle is rolling, you switch it off in transmission position **D** or **R** and bring it to a standstill.
- When the vehicle is rolling, you shift to transmission position **N**, bring the vehicle to a standstill and open the driver's door when the vehicle is stationary.
- Engaging park position **P** automatically is required by the vehicle.
- ⓘ To maneuver with the driver's door open, open the driver's door while the vehicle is stationary and engage transmission position **D** or **R** again.

■ Engaging drive position D

- ▶ Depress the brake pedal and push the DIRECT SELECT lever down past the first point of resistance.

When the automatic transmission is in transmission position **D**, it will shift gears automatically. This depends, among other things, on the following factors:

- The selected drive program
- The position of the accelerator pedal
- The vehicle speed

Manual gear shifting

Permanent setting (vehicles with E-ACTIVE BODY CONTROL)

! NOTE Mercedes-AMG vehicles

- ▶ Observe the notes in the Supplement. You could otherwise fail to recognize dangers.

- i** For vehicles without E-ACTIVE BODY CONTROL, activate or deactivate the permanent setting via the multimedia system (→ page 178).

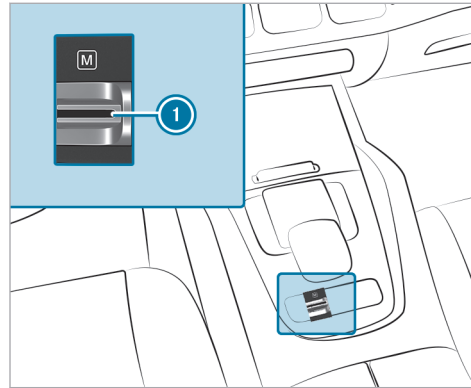

- ▶ **To activate/deactivate:** pull rocker switch **1**. If the indicator lamp is lit, manual gear shifting is activated. The driver display will show the current gear.

Temporary setting

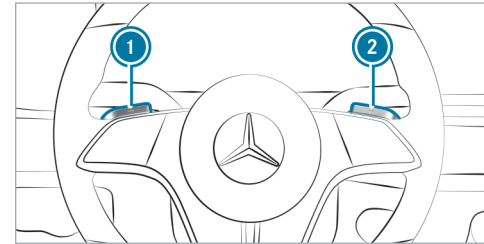

- ▶ **To activate:** pull steering wheel paddle shifter **1** or **2**. Manual gear shifting will be activated for a short time. Transmission position **M** and the current gear will appear on the driver display.
- ▶ **To deactivate:** pull and hold steering wheel paddle shifter **2**. Transmission position **D** will appear on the driver display.
- i** To permanently shift the gears manually in drive program **L+** using the steering wheel paddle shifters, select the **M** setting for the transmission.

Gear shifting

- ▶ **To shift up:** pull steering wheel paddle shifter ②.
- ▶ **To shift down:** pull steering wheel paddle shifter ①.

Permanently activate/deactivate manual gear-shifting

Multimedia system:

- ▶  ▶ Settings ▶ Vehicle ▶ Driving
- ▶ Permanently activate or deactivate the function.

Gearshift recommendation

The gearshift recommendation assists you in adopting an economical driving style.



- ▶ If gearshift recommendation ① appears next to the transmission position display, shift to the recommended gear.

Using kickdown

- ▶ **Maximum acceleration:** depress the accelerator pedal beyond the point of resistance.

To protect against engine overrev, the automatic transmission will shift up to the next gear when maximum engine speed has been reached.

Glide mode function

! NOTE Mercedes-AMG vehicles

- ▶ Observe the notes in the Supplement. You could otherwise fail to recognize dangers.

Glide mode helps you to reduce fuel consumption when you employ an anticipatory driving style.

Glide mode is characterized by the following:

- The internal-combustion engine is switched off depending on the driving situation. All the vehicle functions remain active.
- The transmission position display **D** is shown in green.

Glide mode is activated if the following conditions are met:

- Drive program **E** is selected.
- The speed is within a suitable range.
- The road's course is suitable, e.g. no steep inclines or tight bends.

- There is no trailer coupled up to the trailer hitch, and there is no bicycle rack installed.
 - The state of charge of the battery is sufficient.
 - You do not depress the accelerator or brake pedal (except for light brake applications).
- i** Glide mode can also be activated if you have selected the "Eco" setting for the drive in the drive program .

Glide mode will be deactivated again if one of the conditions is no longer met.

Glide mode can also be prevented by the following parameters:

- Incline
- Downhill gradient
- Temperature
- Altitude
- Speed
- Operating condition of the engine
- Traffic situation

Function of 4MATIC

4MATIC ensures that all four wheels are driven. Together with ESP® and 4ETS, 4MATIC improves the traction of your vehicle whenever a driven wheel spins due to insufficient traction.

If you fail to adapt your driving style, 4MATIC can neither reduce the risk of an accident nor override the laws of physics. 4MATIC cannot take account of road, weather and traffic conditions. 4MATIC is only an aid. You are responsible in particular for maintaining a safe distance from the vehicle in front, for vehicle speed, for braking in good time and for staying in lane.

- i** In wintry road conditions, the maximum effect of 4MATIC can be achieved only if you use winter tires (M+S tires), with snow chains if necessary.

Refueling

Refueling the vehicle

⚠ WARNING Risk of fire or explosion from fuel

Fuels are highly flammable.

- ▶ Fire, open flames, smoking and creating sparks must be avoided.
- ▶ Before refueling, switch off the vehicle and, if installed, the stationary heater, and leave them switched off during refueling.

⚠ WARNING Risk of injury from fuels

Fuels are poisonous and hazardous to your health.

- ▶ Do not swallow fuel or let it come into contact with skin, eyes or clothing.
- ▶ Do not inhale fuel vapor.
- ▶ Keep children away from fuel.

- ▶ Keep doors and windows closed during the refueling process.

If you or other people come into contact with fuel, observe the following:

- ▶ Immediately rinse fuel off your skin with soap and water.
- ▶ If fuel comes into contact with your eyes, immediately rinse them thoroughly with clean water. Seek medical attention immediately.
- ▶ If you swallow fuel, seek medical attention immediately. Do not induce vomiting.
- ▶ Change immediately out of clothing that has come into contact with fuel.

⚠ WARNING Risk of fire and explosion due to electrostatic charge

Electrostatic charge can ignite fuel vapor.

- ▶ Before you open the fuel filler cap or take hold of the pump nozzle, touch the metallic vehicle body.
- ▶ To avoid creating another electrostatic charge, do not get into the vehicle again during the refueling process.

! NOTE Damage caused by the wrong fuel

Vehicles with a gasoline engine:

Even small amounts of the wrong fuel could result in damage to the fuel system, the engine and the emission control system.

- ▶ Refuel only with low-sulfur spark-ignition engine fuel.

This fuel may contain up to 10% ethanol. Your vehicle is suitable for use with E10 fuel.

Never refuel with any of the following fuels:

- Diesel
- Gasoline with more than 10% ethanol by volume, e.g. E15, E85, E100

- Gasoline with more than 3% methanol by volume, e.g. M15, M30, M85, M100
- Gasoline with metallic additives

If you have accidentally refueled with the wrong fuel:

- ▶ Do not switch on the vehicle.
- ▶ Consult a qualified specialist workshop.

! NOTE Do not use diesel to refuel vehicles with a gasoline engine

If you have accidentally refueled with the wrong fuel:

- Do not switch on the vehicle. Otherwise fuel can enter the engine.
Even small amounts of the wrong fuel could result in damage to the fuel system and the engine. The repair costs are high.
- ▶ Consult a qualified specialist workshop.
- ▶ Have the fuel tank and fuel lines drained completely.

! **NOTE** Damage to the fuel system due to overfilling the fuel tank

▶ Only fill the fuel tank until the pump nozzle switches off.

If too much fuel has been added due, for example, to a faulty filling pump:

▶ Do not switch on the vehicle.
▶ Consult a qualified specialist workshop.

! **NOTE** Fuel may spray out when you remove the fuel pump nozzle

▶ Only fill the fuel tank until the pump nozzle switches off.

Requirements:

- The vehicle is unlocked.

Observe the notes on operating fluids and fuel.

Refuel only using fuel that has at least the octane number specified in the information label on the inside of the fuel filler flap. Otherwise, engine out-

put may be reduced and fuel consumption increased.

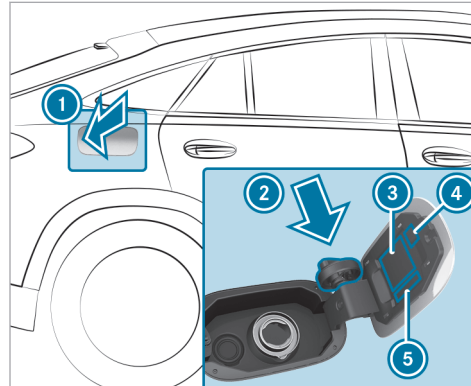

- 1 Fuel filler flap
- 2 Bracket for the fuel filler cap
- 3 Fuel type
- 4 QR code for rescue card
- 5 Tire pressure table

- ▶ Press on the center rear of the fuel filler flap ①.
- ▶ Turn the fuel filler cap counter-clockwise and remove it.
- ▶ Insert fuel filler cap from above into bracket ②.
- ▶ Completely insert the pump nozzle into the tank filler neck, hook in place and refuel.
- ▶ Fill the fuel tank only until the pump nozzle switches off.
- ▶ Replace the fuel filler cap on the tank filler neck and turn clockwise until it engages audibly.
- ▶ Close fuel filler flap ①.

Parking

Parking the vehicle

- ⚠ WARNING** Risk of accident and injury caused by an insufficiently secured vehicle rolling away

If the vehicle is not securely parked sufficiently, it can roll away in an uncontrolled way even at a slight downhill gradient.

- ▶ On uphill or downhill gradients, turn the front wheels so that the vehicle rolls towards the curb if it starts moving.
- ▶ Apply the parking brake.
- ▶ Switch the transmission to position **P**.

- ⚠ WARNING** Risk of fire caused by hot exhaust system parts

Flammable materials such as leaves, grass or twigs may ignite.

- ▶ Park the vehicle so that no flammable material can come into contact with hot vehicle components.

- ▶ In particular, do not park on dry grass-land or harvested grain fields.

- ⚠ WARNING** Risk of accident and injury due to children left unattended in the vehicle

If you leave children unattended in the vehicle, they could, in particular:

- open doors, thereby endangering other persons or road users.
- get out and be struck by oncoming traffic.
- operate vehicle equipment and become trapped, for example.

In addition, the children could also set the vehicle in motion by, for example:

- releasing the parking brake.
 - changing the gearbox position.
 - starting the vehicle.
- ▶ Never leave children unattended in the vehicle.

- ▶ When leaving the vehicle, always take the key with you and lock the vehicle.
- ▶ Keep the key out of reach of children.

- ! NOTE** Damage to the vehicle due to it rolling away

- ▶ Always secure the vehicle against rolling away.

- ! NOTE** Damage due to the vehicle lowering

Vehicles with AIRMATIC or E-ACTIVE BODY CONTROL: The vehicle can lower because of temperature differences or longer non-operational times. This can cause damage to parts of the body.

- ▶ When stopping the vehicle and when driving off, make sure that there are no obstacles such as curbs under or in the immediate vicinity of the body.

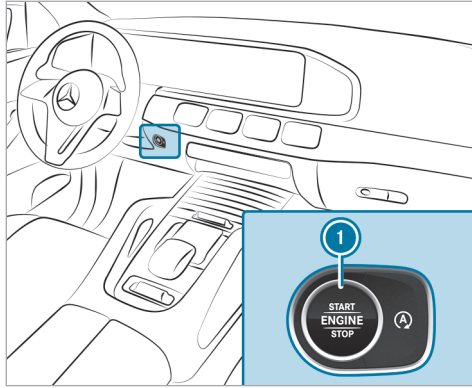

- ▶ Bring the vehicle to a standstill by depressing the brake pedal.
- ▶ On inclines, turn the front wheels so that the vehicle will roll towards the curb if it starts moving.
- ▶ Apply the electric parking brake.

- ▶ Engage transmission position **P** while the vehicle is stationary and the brake pedal is depressed (→ page 176).
 - ▶ Switch off the vehicle by pressing button ①.
 - ▶ Release the service brake slowly.
 - ▶ Get out of the vehicle and lock it.
- ① When you park the vehicle, you can still operate the side windows and the panoramic sliding sunroof for approximately four minutes when the driver's door is closed.

Automatic vehicle shutoff upon locking

Your vehicle is equipped with automatic engine shutoff.

When you leave the vehicle ready to drive, the vehicle will be turned off when locked under the following conditions:

- The ignition is switched on or the engine is running.
- Transmission position **P** is engaged.
- The driver's door is closed.
- **In addition, one of the following conditions must be fulfilled:**

- The vehicle is locked using the vehicle key.
 - **Vehicles with KEYLESS-GO:** the vehicle is locked via KEYLESS-GO on the door handle of a closed door.
 - **Vehicles with KEYLESS-GO:** the vehicle is locked via the locking button on the tailgate.
- ① The engine will continue to run if the vehicle is not locked as described after you have left it. In this case, switch off the vehicle manually.

Automatic vehicle shutoff after a period of time (equipment-dependent)

When the engine is running, the following display message will appear on the driver display when you get out of the vehicle or after a certain hold time in transmission position **P**: **Vehicle Ready to Drive Shutdown Occurs When Locked or Automatically in XX Mins**

The vehicle will then switch off automatically after a total hold time of 20 minutes.

- ① To avoid automatic shutoff after a period of time, acknowledge the corresponding message on the central display of the multimedia system.

The engine will continue to run in the following cases:

- If the vehicle is not locked as described after you have gotten out
- If automatic shutoff is not indicated by the display message
- If automatic shutoff after a period of time has been deactivated via the corresponding message on the central display

In this case, switch off the vehicle manually.

Garage door opener

■ Programming buttons for the garage door opener

⚠ DANGER Risk of death caused by exhaust gases

Combustion engines emit poisonous exhaust gases such as carbon monoxide. Inhaling these exhaust gases is hazardous to health and leads to poisoning.

- ▶ Never leave the engine or, if present, the auxiliary heating running in an enclosed space without sufficient ventilation.

⚠ WARNING Risk of injury by becoming trapped when opening and closing a garage door

When you operate or program a garage door with an integrated garage door opener, persons can become trapped or struck by the garage door if they stand within its range of movement.

- ▶ Always make sure that nobody is within the range of the garage door's movement.

Operate only the following doors using the garage door opener:

- Doors with a safety stop and reversing function
- Doors that conform to the current US safety standards

Before programming the garage door opener, park the vehicle outside the garage. Make sure that the vehicle is switched on but not started.

Requirements

- The vehicle has been parked outside the garage or outside the range of movement of the door.
- The vehicle is switched on.
- The vehicle has not been started.

- ① The garage door opener function will always be available when the vehicle is switched on.

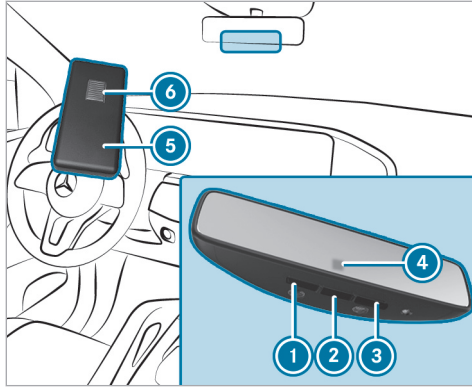

- ▶ Check whether the transmitter frequency of the remote control has the frequency range of 280 to 868 MHz.

Radio equipment approval number:

- NZLMUAHL5 (USA)
- 4112A-MUAHL5 (Canada)

- ▶ Press and hold button ①, ② or ③ that you wish to program. Indicator lamp ④ will flash yellow.
- ① It may take up to 20 seconds before the indicator lamp flashes yellow.
- ▶ Release the previously pressed button. Indicator lamp ④ will continue to flash yellow.
- ▶ Point the remote control ⑤ from a distance of between 0.4 in (1 cm) and 3 in (8 cm) towards button ①, ② or ③.
- ▶ Press and hold button ⑥ of remote control ⑤ until one of the following signals appears:
 - Indicator lamp ④ lights up green continuously. Programming is complete.
 - Indicator lamp ④ flashes green. Programming was successful. Additionally, the rolling code must be synchronized with the door system.
- ▶ If indicator lamp ④ does not light up or flash green: repeat the process.
- ▶ Release all the buttons.

- ① The remote control for the door drive is not included in the scope of delivery for the garage door opener.

■ Synchronizing the rolling code

Requirements

- The door system uses a rolling code.
 - The vehicle must be within range of the garage door or door drive.
 - The vehicle, as well as persons and objects are located outside the range of movement of the door.
- ▶ Press the programming button on the door drive unit. Initiate the next step within approximately 30 seconds.
 - ▶ Press the previously programmed button ①, ② or ③ repeatedly until the door closes. When the door closes, programming is completed.
 - ① Please also read the operating instructions for the door drive.

Troubleshooting during programming of the remote control

- ▶ Check whether the transmitter frequency of the remote control ⑤ is supported.
 - ▶ Replace the batteries in the remote control ⑤.
 - ▶ Hold the remote control ⑤ at various angles in front of the inside mirror from a distance of between 0.4 in (1 cm) and 3 in (8 cm). You should test every position for at least 25 seconds before trying another position.
 - ▶ Hold remote control ⑤ at the same angles at various distances in front of the inside mirror. You should test every position for at least 25 seconds before trying another position.
 - ▶ Press the button ⑥ on the remote control ⑤ again before transmission ends on remote controls that transmit only for a limited period.
 - ▶ Angle the antenna line of the garage door opener unit towards the remote control.
- ① It is possible that older garage doors cannot be operated using the remote control in the inside mirror, even after you have successfully

performed the measures described above. In this case, contact the HomeLink® Hotline.

- ① Support and additional programming information:
- from the toll-free HomeLink® Hotline on 1-800-355-3515
 - online at <https://www.homelink.com/mercedes>

Opening or closing the garage door

Requirements

- The corresponding button is programmed to operate the door.
- ▶ Press and hold buttons ①, ② or ③ until the door opens or closes.
 - ▶ If the indicator lamp ④ flashes yellow after approx. 20 seconds: Press the previously pressed button again and hold pressed until the door opens or closes.

Clearing the garage door opener memory

- ▶ Press and hold buttons ① and ③. Indicator lamp ④ lights up yellow.

- ▶ If indicator lamp ④ flashes green: release buttons ① and ③. The entire memory has been deleted.

Electric parking brake

Function of the electric parking brake (applying automatically)

⚠ WARNING Risk of accident and injury due to children left unattended in the vehicle

If you leave children unattended in the vehicle, they could, in particular:

- open doors, thereby endangering other persons or road users.
- get out and be struck by oncoming traffic.
- operate vehicle equipment and become trapped, for example.

In addition, the children could also set the vehicle in motion by, for example:

- releasing the parking brake.

- changing the gearbox position.
- starting the vehicle.

- ▶ Never leave children unattended in the vehicle.
- ▶ When leaving the vehicle, always take the key with you and lock the vehicle.
- ▶ Keep the key out of reach of children.

The electric parking brake is applied if the transmission is in position **P** and one of the following conditions is fulfilled:

- The vehicle is switched off.
- The driver's seat belt is not fastened and the driver's door is opened.

i To prevent application: pull the handle of the electric parking brake (→ page 188).

In the following situations, the electric parking brake is also applied:

- The HOLD function is keeping the vehicle stationary.

- Active Distance Assist DISTRONIC is bringing the vehicle to a standstill.
- Active Parking Assist is keeping the vehicle stationary.
- **In addition, one of the following conditions must be fulfilled:**
 - The vehicle is switched off.
 - The driver's seat belt is not fastened.
 - There is a system malfunction.
 - The power supply is insufficient.
 - The vehicle is stationary for a lengthy period.
- **Vehicles with Active Parking Assist:** In the following situations, the electric parking brake is also engaged:
 - Following completion of a parking procedure.
 - If an error occurs during a parking procedure.

When the electric parking brake is applied, the red indicator lamp lights up in the driver display **PARK** (USA) or **(P)** (Canada).

i The electric parking brake is not automatically applied if the vehicle is switched off by the ECO start/stop function.

Function of the electric parking brake (automatic release)

The electric parking brake is released when the following conditions are fulfilled:

- The driver's door is closed.
- The vehicle has been started.
- The transmission is in position **D** or **R** and you step on the accelerator pedal, or you shift from transmission position **P** to **D** or **R** on level ground.
- If the transmission is in position **R**, the tailgate must be closed.
- The driver's seat belt is not properly fastened. If the driver's seat belt is not fastened, the following condition must be met:
 - You shift from transmission position **P**.

When the electric parking brake is released, the red **PARK** (USA) or **(P)** (Canada) indicator lamp in the driver display goes out.

■ Applying/releasing the electric parking brake manually

Apply

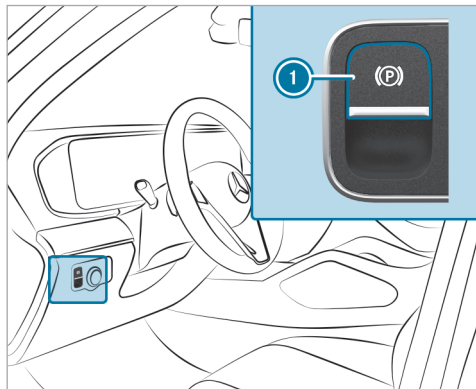

- ▶ Push handle ①.

The red indicator lamp lights up on the driver display **PARK** (USA) or **(P)** (Canada).

- ① The electric parking brake is only securely applied if the red **PARK** (USA) or **(P)** (Canada) indicator lamp is lit continuously.

Release

- ▶ Switch on the vehicle.

- ▶ Pull handle ①.

The red indicator lamp on the driver display goes out **PARK** (USA) or **(P)** (Canada).

■ Emergency braking

- ▶ Press and hold handle ①.

As long as the vehicle is in motion, the **Release Parking Brake** message is displayed and the red indicator lamp **PARK** (USA) or **(P)** (Canada) flashes.

When the vehicle has been braked to a standstill, the electric parking brake is applied. The red indicator lamp **PARK** (USA) or **(P)** (Canada) lights up on the driver display.

Information on collision detection for a parked vehicle

Suppose a collision is detected on the locked vehicle when the tow-away alarm is switched on, and collision detection is switched on. In that case, when the vehicle is switched on, you will receive a message in the multimedia system.

You will receive information about the following points:

- The area of the vehicle that may have been damaged.
- The force of the impact.

The following situation can lead to inadvertent activation:

- For example, the parked vehicle is moved to a two-story garage.

- ① Deactivate the tow-away alarm to prevent inadvertent activation. If you deactivate the tow-away alarm, collision detection will also be deactivated.

You can permanently deactivate collision detection via the multimedia system (→ page 189).

- ❗ If the battery is heavily discharged, the function for detecting a collision on a parked vehicle is automatically deactivated to facilitate the next engine start.

System limits

Detection may be restricted in the following situations:

- the vehicle is damaged without impact, for example, if an outside mirror is torn off or the paint is damaged by a key
 - an impact occurs at low speed
 - the electric parking brake is not applied
- ❗ You are responsible for your vehicle. Convince yourself that your vehicle is free of damage and roadworthy.

Setting collision detection for a parked vehicle

Multimedia system:

→  » Settings » Vehicle
 » Open/Close » Vehicle Protection

- ▶ Activate or deactivate the function via **Collision Notification**.
- ❗ A maximum of three incidents can be registered. Up to 15 photos are taken for every incident. In the event of another incident, the photos of the first incident will be overwritten if they have not been deleted already.

Activating or deactivating the collision photos function

Please note that legal restrictions regarding automatic recording of the vehicle surroundings may be in place in certain countries.

- ▶ Activate or deactivate **Collision Photos**.

Transferring the collision photos with the Mercedes me app

- ▶ Select **Upload Collision Photos**.

or

- ▶ Select **Upload Automatically**.
- ▶ Scan the generated QR code on the media display with the Mercedes me app. The encrypted collision photos will then be uploaded to Mercedes me.

- ❗ Any device that can scan QR codes can be used to view the collision photos in the Mercedes me app.

Copying the collision photos to a USB flash drive

- ▶ Connect a USB flash drive.
- ▶ Select **Manage Collision Photos**.
- ▶ Select **Copy (USB)**. All collision photos are copied to the USB flash drive.

- ❗ Only use FAT32 or exFAT formatted USB storage devices to ensure secure operation.

Deleting collision photos

- ▶ Select **Manage Collision Photos**.
- ▶ Select **Delete**. All collision photos are deleted.

Notes on parking the vehicle for an extended period

If you leave the vehicle parked for longer than six weeks, it may suffer damage through disuse.

The 12 V battery may also be impaired or damaged by heavy discharging.

- ① Further information can be obtained at a qualified specialist workshop.

Standby mode (extension of the starter battery's period out of use)

Standby mode function

- ① This function is not available for all models. If standby mode is activated, energy loss will be minimized during extended idle times.

Standby mode is characterized by the following:

- The starter battery is preserved.
- The maximum idle time appears on the driver display.
- The connection to online services is interrupted.

- The ATA (anti-theft alarm system) is not available.
- The interior protection and tow-away alarm functions are not available.
- The function for detecting collisions when the vehicle is parked is not available.

If the following conditions are fulfilled, standby mode can be activated or deactivated using the multimedia system:

- The vehicle is switched on.
- The vehicle has not been started.

Exceeding the vehicle's displayed idle time may cause inconvenience; i.e. it cannot be guaranteed that the starter battery will reliably start the vehicle.

Charge the starter battery in the following situations:

- If the vehicle's idle time needs to be extended.
- If the starter battery state of charge is insufficient for standby mode.

- ① Standby mode is automatically deactivated when the vehicle is switched on.

Activating/deactivating standby mode (parking up the vehicle)

Requirements

- The vehicle is switched on.
- The vehicle has not been started.

Multimedia system:

➤  ➤ Settings ➤ Vehicle

➤ Other Functions

▶ Activate or deactivate Standby Mode.

Driving and driving safety systems

Driving systems and your responsibility

Your vehicle is equipped with driving systems that assist you in driving, parking and maneuvering the vehicle. The driving systems are only aids. They are not a substitute for you paying attention to your surroundings and do not relieve you of your responsibility pertaining to road traffic law. The driver is always responsible for maintaining a safe

distance to the vehicle in front, for vehicle speed, for braking in good time and for staying in lane. Pay attention to the traffic conditions at all times and intervene when necessary. Be aware of the limitations regarding the safe use of these systems.

Driving systems can neither reduce the risk of an accident if you fail to adapt your driving style nor override the laws of physics. They cannot always take into account road, weather or traffic conditions.

- i** Some driving systems can regulate or limit the speed to a previously set value. Draw attention to the stored speed when changing drivers.

Information on vehicle sensors and cameras

Some driving and driving safety systems use cameras as well as radar or ultrasonic sensors to monitor the area in front of, behind or next to the vehicle.

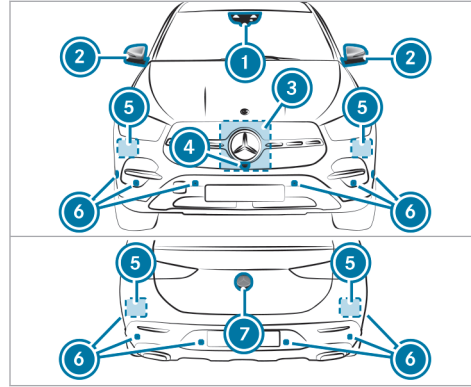

- 1** Multifunction camera
- 2** Cameras in the exterior mirrors
- 3** Front radar
- 4** Front camera
- 5** Corner radars
- 6** Ultrasonic sensors
- 7** Rear-view camera

⚠ WARNING Risk of accident due to restricted detection performance of vehicle sensors and cameras

If the area around vehicle sensors or cameras is covered, damaged or dirty, certain driving and safety systems cannot function correctly. There is a risk of an accident.

- ▶ Keep the area around vehicle sensors or cameras clear of any obstructions and clean.
- ▶ Have damage to the bumper, radiator grille or stone chipping in the area of the front and rear windows repaired at a qualified specialist workshop.

Particularly, keep the areas around the sensors and cameras free of dirt, ice or slush (→ page 343). The sensors and cameras must not be covered and the detection ranges around them must be kept free. Do not attach additional license plate brackets, advertisements, stickers, car foils or rock chip protection films in the detection range of the sensors and cameras. Make sure

there are no overhanging loads protruding into the detection range.

If there is damage to a bumper or the radiator shell, or after an impact, have the function of the sensors checked at a qualified specialist workshop. Have damage or stone chipping in the area of the cameras on the front and rear windows repaired at a qualified specialist workshop.

- ❗ The rear-view camera can extend and retract automatically for the purpose of calibration, even though there is no camera image on the display.

Overview of driving systems and driving safety systems

- ABS (→ page 193)
- BAS (→ page 193)
- ESP® (→ page 194)
- ESP® Crosswind Assist (→ page 195)
- ESP® trailer stabilization (→ page 195)
- EBD (→ page 196)

- STEER CONTROL steering assistance system (→ page 196)
- HOLD function (→ page 197)
- Hill Start Assist (→ page 198)
- ATTENTION ASSIST (→ page 198)
- Cruise control (→ page 200)
- Traffic Sign Assist (→ page 223)
- AIRMATIC (→ page 233)
- E-ACTIVE BODY CONTROL (→ page 237)

Driving Assistance Package

- ❗ The following functions are part of the Driving Assistance Package. Certain functions are available only in some countries. Some functions are also available without the Driving Assistance Package, albeit with restricted functionality.
- Active Distance Assist DISTRONIC (→ page 202)
- Active Speed Limit Assist (→ page 206)
- Route-based speed adaptation (→ page 207)
- DSR (→ page 209)

- Active Brake Assist (→ page 218)
- Active Steering Assist (→ page 212)
- Active Emergency Stop Assist (→ page 214)
- Active Lane Change Assist (→ page 216)
- Active Stop-and-Go Assist (country-dependent) (→ page 209)
- Blind Spot Assist and Active Blind Spot Assist with exit warning (→ page 227)
- Active Lane Keeping Assist (→ page 230)
- PRE-SAFE® Impulse Side (→ page 50)

Parking Package

- ❗ The availability of individual functions depends on country and equipment.
- Rear-view camera (→ page 242)
- 360° camera (→ page 245)
- Parking Assist PARKTRONIC (→ page 251)
- Active Parking Assist (→ page 255)
- Trailer Maneuvering Assist (→ page 263)

Function of ABS

The Anti-lock Brake System (ABS) regulates the brake pressure in critical driving situations:



- During braking, for instance, at maximum full-stop braking or if there is insufficient tire traction, the wheels are prevented from locking.
- Vehicle steerability while braking is ensured.

If ABS intervenes when braking, you will feel a pulsing in the brake pedal. The pulsating brake pedal can be an indication of hazardous road conditions and can serve as a reminder to take extra care while driving.

System limits

- ABS is active from speeds of approx. 3 mph (5 km/h).
- ABS may be impaired or may not function if a malfunction has occurred and the yellow  ABS warning lamp lights up continuously after the vehicle is started.

Function of off-road ABS

 Off-road ABS is activated automatically when you select drive program .

Off-road ABS is specially adapted for driving off-road:

- The front wheels lock cyclically during braking.
- The braking distance is shortened due to the digging-in effect.

System limits

- Off-road ABS functions at speeds below 25 mph (40 km/h).
- If Off-road ABS intervenes, the ability to steer may be restricted.

Function of BAS

 **WARNING** Risk of an accident caused by a malfunction in BAS (Brake Assist System)

If BAS is malfunctioning, the braking distance in an emergency braking situation is increased.

 Depress the brake pedal with full force in emergency braking situations. ABS prevents the wheels from locking.

The Brake Assist System (BAS) supports your emergency braking situation with additional brake force.

If you depress the brake pedal quickly, BAS is activated:

- BAS automatically boosts the brake pressure.
- BAS can shorten the braking distance.
- ABS prevents the wheels from locking.

The brakes will function as usual once you release the brake pedal. BAS is deactivated.

ESP® (Electronic Stability Program)

Function of ESP®

⚠ WARNING Risk of skidding if ESP® is deactivated

If you deactivate ESP®, ESP® cannot carry out vehicle stabilization.

- ▶ ESP® should only be deactivated in the following situations.

! NOTE Mercedes-AMG vehicles

- ▶ Observe the notes in the Supplement. You could otherwise fail to recognize dangers.

The Electronic Stability Program (ESP®) can monitor and improve driving stability and traction in the following situations within physical limits:

- When starting off on wet or slippery roads.
- When braking.

If the vehicle deviates from the direction desired by the driver, ESP® can stabilize the vehicle by intervening in the following ways:

- One or more wheels are braked.
- The engine output is adapted according to the situation.

When ESP® is deactivated, the  warning lamp lights up continuously:

- Driving stability will no longer be improved.
- The drive wheels could spin.
- ETS/4ETS traction control is still active.

When the  warning lamp flashes, one or several wheels has reached its grip limit:

- Adapt your driving style to suit the current road and weather conditions.
- Do not deactivate ESP®.
- Depress the accelerator pedal only as far as is necessary when starting off.

To improve traction, ESP® can be switched off in the following situations:

- When using snow chains.
 - In deep snow.
 - On sand or gravel.
- i** Spinning the wheels results in a cutting action, which enhances traction.

If the  warning lamp lights up continuously, ESP® is not available due to a malfunction.

Observe the following information:

- Warning and indicator lamps (→ page 476)
- Display messages (→ page 419)

ETS/4ETS

ETS/4ETS traction control (Electronic Traction System) is part of ESP® and makes it possible to pull away and accelerate on a slippery road.

If you select drive program  a special ETS/4ETS system specifically suited to terrain is automatically activated.

ETS/4ETS can improve the vehicle's traction by intervening in the following ways:

- The drive wheels are braked individually if they spin.
- More drive torque is transferred to the wheel or wheels with traction.

Influence of drive program on ESP®

The drive programs enable ESP® to adapt to different weather and road conditions as well as the driver's preferred driving style. (→ page 172) Depending on the selected drive program, the appropriate ESP® mode will be activated.

Function of ESP® Crosswind Assist

ESP® Crosswind Assist detects sudden gusts of side wind and helps the driver to keep the vehicle in the lane:

- ESP® Crosswind Assist operates at vehicle speeds between approximately 50 mph (80 km/h) and 125 mph (200 km/h) when you are driving straight ahead or cornering slightly.

- The system stabilizes the vehicle by applying the brakes to specific wheels on one side.

Function of ESP® trailer stabilization

⚠ WARNING Risk of accident in poor road and weather conditions

In poor road and weather conditions, the trailer stabilization cannot prevent lurching of the vehicle/trailer combination. Trailers with a high center of gravity may tip over before ESP® detects this.

- ▶ Always adapt your driving style to suit the current road and weather conditions.

When you are driving with a trailer, ESP® trailer stabilization can stabilize your vehicle if the trailer begins to swerve from side to side:

- ESP® trailer stabilization is active above speeds of 40 mph (65 km/h).
- Slight swerving is reduced by means of the brakes being applied to specific wheels on one side.

- In the event of severe swerving, the drive system output will also be reduced and the brakes will be applied to all wheels.

ESP® trailer stabilization may be impaired or may not function if:

- The trailer is not connected correctly or is not detected properly by the vehicle.

Activating/deactivating ESP® (Electronic Stability Program)

Multimedia system:



- ⓘ ESP® can be activated/deactivated using quick access only when at least one other function is available in quick access. Otherwise, you will find ESP® on the [Assistance](#) or [Offroad](#) menu.

! **NOTE** Mercedes-AMG vehicles

- ▶ Observe the notes in the Supplement. You could otherwise fail to recognize dangers.

- ▶ Select **ESP**.
- ▶ Select **On** or **Off**.

ESP® is deactivated if the  ESP® OFF warning lamp lights up continuously on the driver display.

Observe the information on the warning lamps and the display messages that may be shown on the driver display.

■ Activating/deactivating ESP® (vehicles with E-Active Body Control)

! **NOTE** Mercedes-AMG vehicles

- ▶ Observe the notes in the Supplement. You could otherwise fail to recognize dangers.

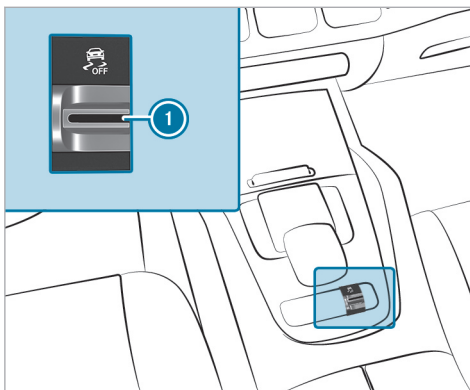

- ▶ Pull rocker switch .

ESP® is deactivated if the  ESP® OFF warning lamp lights up continuously in the driver's display.

Observe the information on warning lamps and display messages that are shown in the driver's display.

Function of EBD

Electronic Brakeforce Distribution (EBD) is characterized by the following:

- Monitoring and regulating the brake pressure on the rear wheels.
- Improved driving stability when braking, especially on bends.

Function of STEER CONTROL

STEER CONTROL assists you by transmitting a noticeable steering force to the steering wheel in the direction required for vehicle stabilization.

This steering recommendation is given in the following situations:

- both right wheels or both left wheels are on a wet or slippery road surface when you brake
- the vehicle starts to skid

System limits

STEER CONTROL may be impaired or may not function in the following situations:

- ESP® is deactivated.
- ESP® is malfunctioning.
- The steering is malfunctioning.

If ESP® is malfunctioning, you will be assisted further by the power steering.

HOLD function

■ HOLD function

The HOLD function holds the vehicle at a standstill without requiring you to depress the brake pedal, e.g. while you are waiting in traffic.

The HOLD function is only an aid. The responsibility for the vehicle safely standing still remains with the driver.

System limits

The HOLD function is intended only to provide assistance during driving and is not a sufficient

means of safeguarding the vehicle against rolling away when stationary.

- The gradient must not be greater than 30%.

■ Activating/deactivating the HOLD function

▲ WARNING Risk of an accident due to the HOLD function being active when you leave the vehicle

If the vehicle is only braked with the HOLD function it could, in the following situations, roll away:

- If there is a malfunction in the system or in the power supply.
 - If the HOLD function is deactivated by depressing the accelerator pedal or brake pedal, e.g. by a vehicle occupant.
- ▶ Always secure the vehicle against rolling away before you leave it.

Requirements

- The vehicle is stationary.

- The driver's door is closed or the driver is correctly belted.
- The vehicle has been started or has been automatically switched off by the ECO start/stop function.
- The electric parking brake has been released.
- The transmission position **[D]**, **[R]** or **[N]** is engaged.

Activating the HOLD function

- ▶ Depress the brake pedal, and after a short time quickly depress further until the **[HOLD]** display appears on the driver display.
- ▶ Release the brake pedal.

Deactivating the HOLD function

- ▶ Depress the accelerator pedal to start off.
- or
- ▶ Depress the brake pedal until **[HOLD]** disappears from the driver display.

The HOLD function is also deactivated in the following situations:

- The parking position **[P]** is engaged.

- The vehicle is secured with the electric parking brake.

In the following situations, the vehicle is held by the parking position **P** and/or electric parking brake:

- The seat belt is unfastened and the driver's door is opened.
- The vehicle is switched off.
- There is a system malfunction.
- The power supply is insufficient.

- ▶ Immediately depress the brake pedal firmly. The HOLD function is deactivated.
- ▶ Additionally secure the vehicle against rolling away.

Function of Hill Start Assist

⚠ WARNING Risk of accident and injury due to the vehicle rolling away

After a short time, Hill Start Assist no longer holds the vehicle.

▶ Swiftly move your foot from the brake pedal to the accelerator pedal. Do not leave the vehicle when it is being held by Hill Start Assist.

Hill Start Assist holds the vehicle for a short time when you pull away uphill under the following conditions:

- The transmission position **D** or **R** for starting off uphill is selected.
- The electric parking brake has been released.

This gives you enough time to move your foot from the brake pedal to the accelerator pedal and depress it without the vehicle rolling away immediately.

ATTENTION ASSIST

■ Function of ATTENTION ASSIST

ATTENTION ASSIST assists you on long, monotonous journeys, e.g. on freeways and highways. If signs of fatigue or increasing lapses in concentration on the part of the driver are detected, the system will suggest taking a break.

ATTENTION ASSIST serves solely as an aid. It cannot always promptly detect fatigue or lapses in concentration. The system is not a substitute for a well-rested and attentive driver. On long journeys, take regular, timely breaks to allow for adequate recovery.

You can choose between two settings:

- **Standard:** normal system sensitivity.
- **Sensitive:** higher system sensitivity. The driver will be warned earlier and the attention level detected by the system will be adapted accordingly.

If fatigue or increasing inattention is detected, the driver display will show the following warning: **ATTENTION ASSIST: Take a Break!** You can acknowledge the message and take a break if necessary. If you do not take a break and ATTENTION ASSIST continues to detect increasing lapses in concentration, you will be warned again after a minimum of 15 minutes.



The following information will be shown on the driver display:

- journey time since the last break.
- the attention level determined by ATTENTION ASSIST

The more segments ① of the circle displayed, the higher the detected attention level. Fewer segments ① will be displayed in the circle as the attention level decreases.

If ATTENTION ASSIST is unable to calculate the attention level and therefore cannot issue a warning, a message reading **System Suspended** will appear.

If the driver display shows a warning, the MBUX multimedia system will offer to search for a rest area. You can select a rest area and start navigation to this rest area.

When you restart the vehicle, ATTENTION ASSIST will automatically be switched on. The last selected sensitivity level will remain stored.

System limits

ATTENTION ASSIST will be active in the 37 mph (60 km/h) to 124 mph (200 km/h) speed range.

If the system is unavailable due to a malfunction, the  ATTENTION ASSIST warning lamp will light up continuously on the driver display.

Functionality of ATTENTION ASSIST will be restricted, and warnings may be delayed or not issued at all in the following situations in particular:

- If you have been driving for less than approximately 30 minutes
- If the road condition is poor (uneven road surface or potholes)
- If there is a strong side wind

- If you adopt a sporty driving style (high cornering speeds or high rates of acceleration)
- If the Active Steering Assist function of Active Distance Assist DISTRONIC is active
- If the clock is set to the incorrect time.
- If you change lanes and vary your speed frequently in active driving situations.

Refer also to the information regarding display messages that can be shown on the driver display.

The ATTENTION ASSIST drowsiness or alertness assessment will be reset and restarted when you continue your journey in the following situations:

- If you switch off the vehicle.
- If you unfasten your seat belt and open the driver's door (e.g. to change drivers or take a break).



Setting ATTENTION ASSIST

Multimedia system:

- 

 Settings
 
 Assistance
 
 ATTENTION ASSIST

Setting the sensitivity

-  Select  next to ATTENTION ASSIST.
-  Select Standard or Sensitive.

Speed control cruise control

Function of cruise control

Cruise control regulates the speed to the value selected by the driver.



For example, the stored speed will not be deleted if you accelerate to overtake. If you remove your foot from the accelerator pedal after overtaking, cruise control will resume speed regulation back to the stored speed.

You can set any speed above 15 mph (20 km/h) up to the maximum design speed.

Observe the notes on driving systems and your responsibility; you may otherwise fail to recognize potential dangers (→ page 190).

Mercedes-AMG vehicles: cruise control is available up to a maximum speed of 155 mph (250 km/h).

Indicators on the driver display

-  **Gray:** cruise control is selected but not yet active or temporarily in passive mode.
-  **Green:** cruise control is active.

A stored speed will appear below the  display and be indicated on the speedometer.

System limits

Cruise control may be unable to maintain the stored speed on uphill gradients. The stored speed will be resumed when the gradient levels out.

On long and steep downhill gradients, you must shift down to a lower gear in good time. This is particularly important when you are driving a loaded vehicle. By doing so, you will make use of the engine's braking effect. This will take some of the

strain off the brake system and prevent the brakes from overheating and wearing too quickly.

Do not use cruise control in the following situations:

- in traffic situations that require frequent changes of speed, e.g. in heavy traffic, on winding roads
- on slippery roads. Accelerating may cause the drive wheels to lose traction and the vehicle could then skid.
- when visibility is poor

Operating cruise control

 **WARNING** Risk of accident due to stored speed

If you call up the stored speed and this is lower than your current speed, the vehicle decelerates.

-  Take into account the traffic situation before calling up the stored speed.

Requirements

- The transmission is in position .

- The vehicle speed is at least 15 mph (20 km/h).
- ESP® must be activated, but not intervening.
- Cruise control is selected.

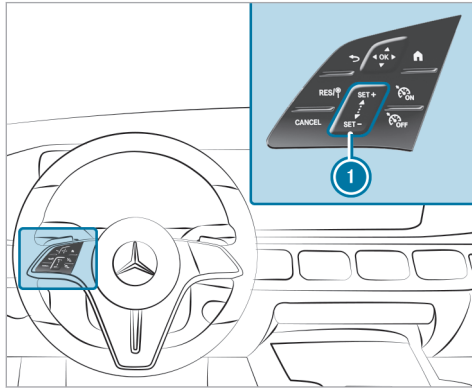

Steering wheel control panel for cruise control

RES/+ Adopts the stored/detected speed

CANCEL Deactivates cruise control

① **SET+** **SET-** Control panel to increase/decrease speed

ON Switches on cruise control

OFF Switches off cruise control

Switching on cruise control:

▶ Press **ON**.

Activating cruise control:

▶ Press **SET+** or **SET-** on the control panel ①. The current vehicle speed will be stored and maintained by the vehicle.

or

▶ Press **RES/+**. The last stored speed will be called up and maintained by the vehicle. The current vehicle speed will be stored if the most recently stored speed has been deleted.

① When you switch off the vehicle, the last speed stored will be deleted.

Increasing/decreasing the stored speed:

▶ To increase the stored speed: swipe upwards from the bottom of the control panel ①.

- The stored speed will be increased by 1 mph (1 km/h).

▶ To decrease the stored speed: swipe downwards from the top of the control panel ①.

- The stored speed will be decreased by 1 mph (1 km/h).

or

▶ Briefly press **SET+** or **SET-** on control panel ①.

The stored speed will be increased or decreased to the following values depending on the unit:

- **mph:** the next value ending in 5
- **km/h:** the next value ending in 0

or

▶ Accelerate the vehicle to the desired speed.

▶ Press **SET+** on control panel ①.

Adopting a detected speed:

If cruise control is activated and Traffic Sign Assist has detected a traffic sign with a maximum

permissible speed and this is shown on the driver display:

- ▶ Press **RES/⏪**.
The maximum permissible speed shown by the traffic sign will be stored and the vehicle will maintain that speed.

Deactivating cruise control

- ▶ Press **CANCEL**.

Switching off cruise control

- ▶ Press **CC OFF**.

- ⓘ If you brake or deactivate ESP® or if ESP® intervenes, cruise control will be deactivated.

Active Distance Assist DISTRONIC

Function of Active Distance Assist DISTRONIC

Active Distance Assist DISTRONIC maintains the set speed on free-flowing roads. If vehicles are detected ahead the set distance is maintained, if necessary until the vehicle comes to a standstill. The vehicle accelerates or brakes depending on

the distance to the vehicle in front and the set speed.

The speed and distance to the vehicle in front are set and saved using the steering wheel.

Available speed range: 15 mph (20 km/h) - 100 mph (160 km/h)

Vehicles with Driving Assistance Package: 15 mph (20 km/h) - 100 mph (160 km/h), or in certain countries up to 130 mph (210 km/h).

Other features of Active Distance Assist DISTRONIC:

- Adjusts the driving style depending on the selected drive program
- Initiates acceleration to the stored speed if the turn signal indicator is switched on to change to the overtaking lane
- **Vehicles with Driving Assistance Package:**
 - Reacts to stationary vehicles detected in urban speed ranges (except bicycles and motorcycles)
 - Takes one-sided overtaking restrictions into account on freeways or multi-lane

roads with separate roadways (country-dependent)

- ⓘ In the Active Distance Assist menu, it is possible to set the driving mode of Active Distance Assist DISTRONIC. Depending on the selected drive program, the driving behavior is energy-saving, comfortable or dynamic (→ page 208).

Vehicles with Driving Assistance Package and Parking Package: if the vehicle has been braked to a standstill on multi-lane, separate roadways by Active Distance Assist DISTRONIC, it can automatically follow the vehicle in front when driving off again within 30 seconds. If a critical situation is detected when you are driving off, a visual and acoustic warning is issued indicating that the driver must now take control of the vehicle. The vehicle is not accelerated any further.

Observe the notes on driving systems and your responsibility, otherwise you may fail to recognize potential dangers (→ page 190).

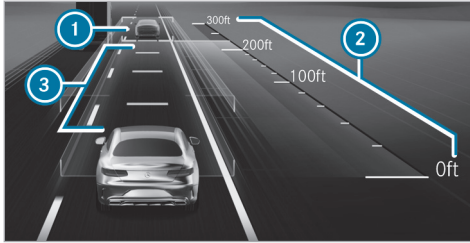

Notification on the driver display in the [Assistance](#) menu

- ① Vehicle in front
- ② Distance indicator
- ③ Set specified distance

The vehicle detected in front ① is highlighted in green. It may also be in the lane to the right of your vehicle in situations where it is not permitted to overtake on the left, for example, on UK free-ways.

Permanent status display

 **Gray:** Active Distance Assist DISTRONIC selected but not yet active



 **Green speedometer, gray vehicle:** Active Distance Assist DISTRONIC active, speed set

 **Green:** Active Distance Assist DISTRONIC active and vehicle detected

The stored speed is shown under the permanent status display and highlighted in the speedometer. Active Distance Assist DISTRONIC's status display is grayed out when in passive mode.

If the speed of the vehicle in front or the ascertained target speed due to the route event ahead is less than the stored speed, the segments in the speedometer light up.

If you increase or decrease the set specified distance ③, the  display appears briefly.

- ① The green vehicle symbol  is displayed cyclically when the vehicle is ready to pull away.
- ② If the accelerator pedal is depressed while Active Distance Assist DISTRONIC is operational, the system can be switched to passive mode. The  **Suspended** message appears briefly on the driver display.

System limits

The system may be impaired or inoperative in the following instances, for example:

- In snow, rain, fog, heavy spray, if there is glare, in direct sunlight or in greatly varying ambient light.
- If there is swirling dust, e.g. when you are driving off-road or on sandy surfaces.
- The windshield in the camera's area is dirty, fogged up, damaged or covered.
- If the radar sensors are dirty or covered.
- In parking garages or on roads with steep uphill or downhill gradients.
- If there are narrow vehicles in front, such as bicycles or motorcycles.

In addition, one or more wheels may lose grip due to braking or acceleration on smooth or slippery roads, and the vehicle may begin skidding. If ESP[®] intervenes, Active Distance Assist DISTRONIC is deactivated.

Do not use Active Distance Assist DISTRONIC in these situations.

⚠ WARNING Risk of accident from acceleration or braking by Active Distance Assist DISTRONIC

Active Distance Assist DISTRONIC may accelerate or brake in the following cases, for example:

- If the vehicle pulls away using Active Distance Assist DISTRONIC.
- If the stored speed is called up and is considerably faster or slower than the currently driven speed.
- If Active Distance Assist DISTRONIC no longer detects a vehicle in front or does not react to relevant objects.

- ▶ Always carefully observe the traffic conditions and be ready to brake at all times.
- ▶ Take into account the traffic situation before calling up the stored speed.

⚠ WARNING Risk of accident due to insufficient deceleration by Active Distance Assist DISTRONIC

Active Distance Assist DISTRONIC brakes your vehicle with up to 50% of the possible deceleration. If this deceleration is not sufficient, Active Distance Assist DISTRONIC alerts you with a visual and acoustic warning.

- ▶ Adjust your speed and maintain a suitable distance from the vehicle in front.
- ▶ Brake the vehicle yourself and/or take evasive action.

⚠ WARNING Risk of accident if detection function of Active Distance Assist DISTRONIC is impaired

Active Distance Assist DISTRONIC does not react or has a limited reaction:

- when driving on a different lane or when changing lanes

- to pedestrians, animals, bicycles or stationary vehicles, or unexpected obstacles
- to complex traffic conditions
- to oncoming vehicles and crossing traffic

As a result, Active Distance Assist DISTRONIC may neither give warnings nor intervene in such situations.

- ▶ Always observe the traffic conditions carefully and react accordingly.

■ Operating Active Distance Assist DISTRONIC

Requirements:

- The electric parking brake has been released.
- ESP® is switched on and is not intervening.
- Transmission position **D** is engaged.
- All the doors are closed.
- The check on the radar sensor system has been successfully completed.
- DSR is switched off (→ page 211).
- The  drive program is switched off (→ page 170).

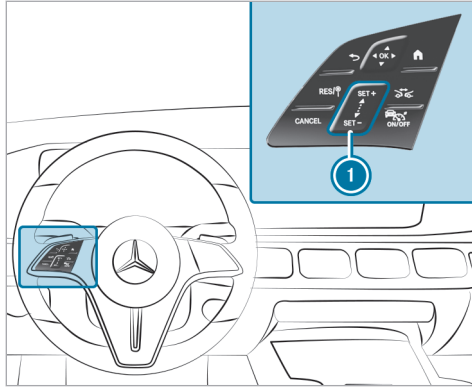

RES/☺

CANCEL

① SET+ SET-

↔

Adopts the stored/detected speed
Deactivates Active Distance Assist
DISTRONIC

Control panel to increase/decrease
speed

Increases/decreases the specified
distance

Activates/deactivates Active Dis-
tance Assist DISTRONIC

▶ To operate Active Distance Assist
DISTRONIC: press the respective button with
only one finger or swipe across the control
panel.

Activates/deactivates Active Distance Assist DISTRONIC

▶ Press .

Activating Active Distance Assist DISTRONIC

▶ To activate without a stored speed: press the
control panel ① on the top or on the
bottom or press . Remove your foot
from the accelerator pedal.

or

▶ To activate with a stored speed: press .

Remove your foot from the accelerator pedal.
The last stored speed will be called up and
maintained by the vehicle.

If the stored speed has been deleted, the cur-
rent vehicle speed will be stored.

Increasing or decreasing the speed

- ▶ To increase the stored speed: swipe upwards
from the bottom of control panel ①.
- The stored speed will be increased by
1 mph (1 km/h).
- ▶ To decrease the stored speed: swipe down-
wards from the top of control panel ①.
- The stored speed will be decreased by
1 mph (1 km/h).

or

▶ Briefly press the top or bottom of
control panel ①.
The stored speed will be increased or
decreased by 5 mph (10 km/h).

or

- ▶ Accelerate the vehicle to the desired speed.
▶ Press the top of control panel ①.

Adopting the speed restriction shown on the driver display

▶ Activate Active Distance Assist DISTRONIC:
press , or .

▶ Adopt the displayed speed restriction: press . The speed restriction shown on the driver display will be adopted as the stored speed. The vehicle will adapt its speed to that of the vehicle in front, but only up to the stored speed, or will limit its speed accordingly.

❶ A speed restriction shown on the driver display will be adopted only while the vehicle is in motion, not when it is stationary.



Pulling away with Active Distance Assist DISTRONIC

▶ Activate Active Distance Assist DISTRONIC and remove your foot from the brake pedal.
▶ Press .

or

▶ Depress the accelerator pedal briefly and firmly. The functions of Active Distance Assist DISTRONIC will remain active.

Increasing or decreasing the specified distance from the vehicle in front

▶ Press . The  indicator will appear. The specified distance will be reduced by one level. If the lowest level is already selected, the selection will jump to the highest level.

Deactivating Active Distance Assist DISTRONIC

⚠ WARNING Risk of an accident due to Active Distance Assist DISTRONIC being active when you leave the driver's seat

If you leave the driver's seat while the vehicle is being braked by Active Distance Assist DISTRONIC only, the vehicle can roll away.

▶ Always deactivate Active Distance Assist DISTRONIC and secure the vehicle to prevent it from rolling away before you leave the driver's seat.

▶ Press .

❶ If you brake or deactivate ESP® or if ESP® intervenes, Active Distance Assist DISTRONIC will be deactivated.

Function of Active Speed Limit Assist

If a change in speed limit is detected and the automatic adoption of speed limits is switched on, this will automatically be adopted as the set speed (→ page 208). Speed limits below 12 mph (20 km/h) will not be adopted.

The vehicle's speed will be adjusted when the vehicle is level with the traffic sign at the latest. In the case of signs indicating entry into an urban area, the speed will be adapted according to the speed permitted within the urban area. The speed limit indicator on the driver's display will always be updated when the vehicle is level with the traffic sign.

If you are driving on German motorways with no speed limit, the system will use the speed stored for a stretch of road with no speed limit as the set speed. If you do not alter the set speed on a stretch of road with no speed limit, the recommended speed of 80 mph (130 km/h) will be adopted.

If Active Distance Assist DISTRONIC has been switched to passive mode as a result of you pressing the accelerator pedal, only speed limits that are higher than the set speed will be adopted.

The maximum permissible speed does not take the road condition and current weather and traffic conditions into consideration. Adjust your speed accordingly when necessary.

Observe the notes on driving systems and your responsibility; you may otherwise fail to recognize potential dangers (→ page 190).

System limits

The system limits of Traffic Sign Assist apply to the detection of traffic signs (→ page 223).

Speed limits below 12 mph (20 km/h) will not automatically be adopted by the system as the set speed. Temporary speed restrictions (e.g. for a specific time or due to weather conditions) cannot be unequivocally detected by the system.

Adjust your speed in these situations.

⚠ WARNING Risk of accident due to speed adaptation via Active Speed Limit Assist

The speed limit adopted by Active Speed Limit Assist may be too high or otherwise erroneous in certain circumstances:

- in the case of speed limits below 12 mph (20 km/h)
 - due to weather, e.g. in wet or foggy conditions
- ▶ Ensure that the vehicle speed always complies with the traffic regulations.
- ▶ Adjust the vehicle speed to the current traffic and weather conditions.

■ Function of route-based speed adaptation

When Active Distance Assist DISTRONIC is activated, the vehicle speed will be adapted accordingly to the route events ahead. Depending on the drive program selected, the vehicle will negotiate a route event ahead in an energy-saving, comfortable or dynamic manner. When the route event has been passed, the vehicle will accelerate again to the stored speed. The set distance to the vehicle

in front, vehicles detected ahead and speed restrictions ahead will be taken into account.

Route-based speed adaptation can be activated in the multimedia system (→ page 208).

The following route events will be taken into account:

- Bends
- Traffic circles
- T-intersections
- Turns and exits

Also, the speed will be reduced if the turn signal indicator is switched on and one of the following situations is detected:

- Turning off at intersections
- Driving in slowing-down lanes
- Driving in lanes adjacent to slowing-down lanes

The driver is responsible for choosing the right speed and observing other road users. This applies in particular to intersections, traffic circles

and traffic lights, as route-based speed adaptation does not brake the vehicle to a standstill.

When route guidance is active, the first speed adjustment will be carried out automatically. If the turn signal indicator is switched on, the selected route will be confirmed and further speed adjustment will be activated.

Speed adjustment will be canceled in the following cases:

- If the turn signal indicator is switched off before the route event and it is therefore assumed that the route event is not relevant to the driver
- If the driver depresses the accelerator or brake pedal during the process

System limits

Route-based speed adaptation does not take right of way regulations into account. The driver is responsible for complying with road traffic regulations and driving at a suitable speed.

In difficult conditions, the speed selection made by the system may not always be suitable. This applies to the following situations, for example:

- The road's course is not clearly visible
- Road narrowing
- Varying maximum permissible speeds in individual lanes, e.g. at toll stations
- Wet road surfaces, snow or ice
- If transport equipment, such as a trailer or bicycle rack, is attached to the trailer hitch and the electrical connection has been correctly established.

The driver will need to intervene accordingly in these situations.

⚠ WARNING Risk of accident in spite of route-based speed adaptation

Route-based speed adaptation can malfunction or be temporarily unavailable in the following situations:

- If the driver does not follow the calculated route
 - If map data is not up-to-date or available
 - In the event of roadworks
 - In bad weather or road conditions
 - If the accelerator pedal is depressed
 - In the event of electronically displayed speed limitations
- ▶ Adapt the speed to the traffic situation.

■ Setting the driving style of Active Distance Assist DISTRONIC

Requirements:

- Active Distance Assist DISTRONIC is activated.

Multimedia system:

→  » Settings » Assistance
» Driving » Active Distance Assist

Selecting a driving style

▶ Select **Based on DYNAMIC SELECT**, **Dynamic** or **Comfortable**.

 Additional information on Active Distance Assist DISTRONIC (→ page 202).

Setting speed adaptation

▶ Select **Adopt Speed Limit** or **Route-based Speed Adaptation**.

When these functions are active, the travel speed is adapted depending on the route events ahead or in accordance with a speed restriction.

 If one of the following systems is activated, the detected speed can be manually adopted as the maximum permissible speed:

- Active Distance Assist DISTRONIC
- Variable limiter

 Additional information on speed adaptation (→ page 207).

Function of Active Stop-and-Go Assist

Active Stop-and-Go Assist helps you in traffic jams on multi-lane roads with separate roadways by automatically pulling away within up to 60 seconds and with moderate steering maneuvers. It orients itself using the vehicle in front and lane markings. Active Stop-and-Go Assist automatically maintains a safe distance from the vehicle in front and vehicles cutting in.

Active Stop-and-Go Assist requires you, as the driver, to keep your hands on the steering wheel at all times so that you can intervene at any time to correct the course of the vehicle and keep it in the lane.

Observe the notes on driving systems and your responsibility; you may otherwise fail to recognize potential dangers (→ page 190).

If all of the following conditions are met, Active Stop-and-Go Assist activates automatically:

- You are in a traffic jam on a highway or major high-speed road.

- Active Distance Assist DISTRONIC is switched on and active (→ page 204).
- Active Brake Assist is available (→ page 218).
- Active Steering Assist is switched on and active (→ page 214).
- You are traveling no faster than 35 mph (60 km/h).

When Active Stop-and-Go Assist is active, the  status display appears in the driver display.

System limits

The system limits of Active Distance Assist DISTRONIC and Active Steering Assist apply to Active Stop-and-Go Assist.

DSR (Downhill Speed Regulation)

Function of the DSR system

DSR is a downhill driving assist function. It keeps the speed of travel at the selected target speed. The steeper the downhill gradient, the greater the DSR braking effect on the vehicle. On flat stretches of road and uphill gradients, the DSR brakes the vehicle minimally or not at all.

210 Driving and parking

When DSR is activated and the transmission is in position **D**, **R** or **N**, DSR controls the driving speed. The target speed can be set to a value between 1 mph (2 km/h) and 11 mph (18 km/h). By braking or accelerating, you can drive at a higher or lower speed than the target speed at any time.

DSR will be switched off automatically

- If you are driving at a speed greater than 28 mph (45 km/h)
- If you change the drive program

The  **Off** message will appear on the driver display. The status display in the driver display goes out. You also hear a warning tone.

- ① DSR remains activated in the drive program .

Information on DSR

 **WARNING** Risk of skidding and accident when DSR is activated on slippery road surfaces

If the driven speed and the target speed differ, the wheels may lose traction.

- ▶ Take into account the road surface and the difference between the driving speed and target speed before activating DSR.

Observe the notes on driving systems and your responsibility; you may otherwise fail to recognize potential dangers (→ page 190).

You are always responsible for keeping control of the vehicle and for assessing whether the downhill gradient can be negotiated. Depending on road surface conditions and tires, DSR may not always be able to maintain the target speed. Select a target speed suitable for the environmental conditions and also apply the brakes yourself if required.

Activating/deactivating DSR (vehicles with E-Active Body Control)



Requirements:

- You are driving at 24 mph (40 km/h) or slower.

If the vehicle speed is too high, a message reading **Do Not Exceed 25 mph** will appear on the driver display.

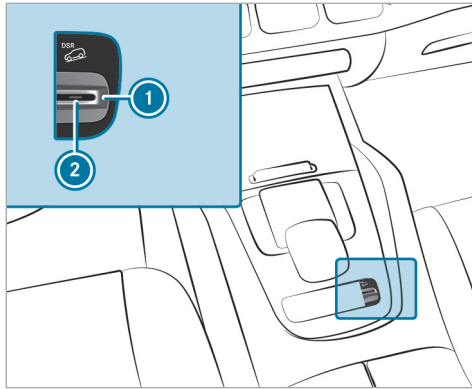
- You have not selected the **S** drive program.
- Active Distance Assist DISTRONIC is deactivated.



- ▶ **To activate:** pull rocker switch ①. Indicator lamp ② will light up. The  symbol will appear on the driver display.
- ▶ **To deactivate:** pull rocker switch ①. Indicator lamp ② and the  symbol will go out.

Activating or deactivating DSR (Downhill Speed Regulation)

Requirements

- You are driving at 24 mph (40 km/h) or slower.
If the vehicle speed is too high, the **Max. speed 40 km/h** message appears in the driver display.
- Active Distance Assist DISTRONIC, cruise control and variable limiter are switched off.

Multimedia system:

→  ▶ Settings ▶ Assistance

- ▶ Select .
A status display appears when the function is activated in the driver display.

Changing the target speed

When DSR is activated, you can change the target speed to a value between 1 mph (2 km/h) and 11 mph (18 km/h).

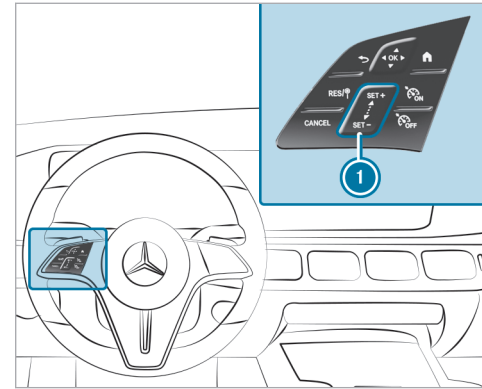

- ▶ **To increase the target speed:** swipe upwards from the bottom of the switch panel ①.
 - The target speed is increased by 1 mph (1 km/h).
- or
- ▶ At the top of the switch panel ①, press  and hold pressed. The target speed is increased in 1 mph (1 km/h) increments.

- ▶ **To decrease the target speed:** swipe downwards from the top of the switch panel ①.
- The target speed is decreased by 1 mph (1 km/h).

or

- ▶ At the top of the switch panel ①, press  and hold pressed.
The target speed is 1 mph (reduced in 1 km/h) increments.

The set target speed is indicated under the green status display  in the driver display.

- ① This may then be increased or decreased only when the set target speed is reached.

Active Steering Assist

Function of Active Steering Assist

Active Steering Assist is available up to a speed of 100 mph (160 km/h), or in certain countries up to 130 mph (210 km/h).





The system helps you to stay in the center of the lane by means of moderate steering interventions. Depending on the vehicle speed, Active Steering

Assist uses the vehicles ahead and lane markings as a reference.

- ① Depending on the respective country, Active Steering Assist can use the surrounding traffic as a reference in the lower speed range. If necessary, Active Steering Assist can also assist when you are driving outside the center of the lane, for example, to form an emergency corridor.

If the detection of lane markings and vehicles ahead is impaired, Active Steering Assist switches to passive mode. The system provides no support in this case.

Status display of Active Steering Assist

-  **Gray:** activated and in passive mode
-  **Green:** activated and active
-  **Red, flashing:** prompt to the driver to actively confirm or transition from active to passive mode, system limits detected
-  **White, red hands:** "hands on the steering wheel" prompt

- ① During the transition from active to passive mode, the  symbol is shown as enlarged

and flashing. Once the system is in passive mode, the  symbol is shown as gray on the driver display.

- ① Depending on the selected vehicle settings, Active Steering Assist may be unavailable.

Steering and touch detection

The driver is required to keep their hands on the steering wheel at all times to ensure that they can intervene at any time to correct the course of the vehicle and keep it in lane. The driver must expect a change from active to passive mode or vice versa at any time.

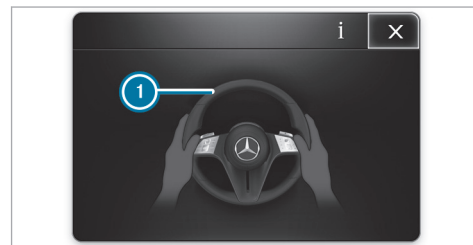

If the system detects that the driver has not steered the vehicle for a considerable period of

time or has removed their hands from the steering wheel, an initial visual warning is issued. The notification **1** appears on the driver display. If the driver still does not steer the vehicle, or gives no confirmation to the system, a warning tone sounds in addition to the visual warning message.

If the driver does not react to this warning for a considerable period, an emergency stop may be initiated (→ page 214).

The warning is not issued or stops as soon as the system detects the driver touching or steering the steering wheel.

Touch detection may be limited or inoperative if there is no direct contact between the hand and the steering wheel, e.g. when you are wearing gloves or if there is a steering wheel cover on the steering wheel.

If Active Steering Assist detects that a system limit has been reached, a visual warning is issued and a warning tone sounds.

Observe the notes on driving systems and your responsibility, otherwise you may fail to recognize potential dangers (→ page 190).

System limits

Active Steering Assist has a limited steering torque for lateral guidance. In some cases, the steering intervention is not sufficient to keep the vehicle in the lane or to drive through exits.

The system may be impaired or inoperative in the following situations:

- There is poor visibility, e.g. due to snow, rain, fog, heavy spray, greatly varying ambient light or dense shadows on the road.
- There is glare, e.g. from oncoming traffic, direct sunlight or reflections.
- Insufficient road illumination.
- The windshield is dirty, fogged up, damaged or covered in the vicinity of the camera, e.g. by a sticker.
- There are no lane markings in a given lane, or the markings are not easily discernible or change quickly, for example, in a construction area or at intersections.
- The lane markings are worn away, dark or covered up, e.g. by dirt or snow.

- If the distance to the vehicle in front is too short and the lane markings can therefore not be detected.
- The roadway is narrow and winding.
- There are obstacles on the lane or projecting out into the lane, such as object markers.
- If transport equipment, e.g. a trailer or bicycle rack, is attached to the trailer hitch and the electrical connection has been correctly established.

The system does not provide assistance in the following conditions:

- On very tight bends and when turning.
- When crossing intersections.
- At traffic circles or toll stations.
- When actively changing lane without switching on the turn signal indicator.
- When the tire pressure is too low.

⚠ WARNING Risk of accident if Active Steering Assist unexpectedly stops functioning

If the system limits of Active Steering Assist are reached there is no guarantee that the system will remain active or will keep the vehicle in lane.

- ▶ Always keep your hands on the steering wheel and observe the traffic carefully.
- ▶ Always steer the vehicle paying attention to traffic conditions.

⚠ WARNING Risk of accident if Active Steering Assist unexpectedly intervenes

The detection of lane markings and objects may malfunction and cause unexpected steering interventions.

- ▶ Steer according to traffic conditions.

■ Activating/deactivating Active Steering Assist

Requirements:

- ESP® is activated, but is not intervening.

- Active Distance Assist DISTRONIC is activated.

Multimedia system:

→  >> Settings >> Assistance
>> Driving

- ▶ Activate or deactivate **Active Steering Assist**.

Function of Active Emergency Stop Assist

i The following function is available only in combination with the Driving Assistance Package.

Active Emergency Stop Assist monitors the steering wheel, as well as the accelerator and brake pedals. If the system detects a lack of driver activity or the vehicle is in danger of leaving the lane, a warning can be issued and an emergency stop initiated.

If Active Steering Assist is switched off, the system is available from a speed of approx. 37 mph (60 km/h), depending on the respective country.

If the system detects that the vehicle is in danger of leaving the lane, a warning can be issued and an emergency stop initiated.

- The driver has not touched the steering wheel for a certain while or no steering movement is detected for a lengthy period (depending on the vehicle equipment).
 - Neither the accelerator nor the brake pedal is depressed.
- i** If Active Steering Assist is switched on and active, the system only monitors the steering wheel. If the driver has not touched the steering wheel for a certain while, a warning may be issued despite pedal actuation. Observe also the instructions on the touch detection of Active Steering Assist (→ page 212).

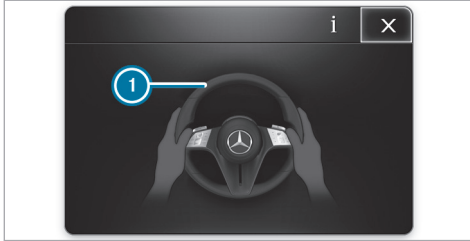

Active Emergency Stop Assist issues the following warnings in order:

- Display message ① appears on the driver display.
- In addition to the display ①, a warning tone sounds.
- The **Initiating Emergency Stop** message appears on the driver display, a continuous warning tone sounds and the vehicle will no longer accelerate.
- The vehicle speed is reduced in increments until the vehicle comes to a standstill. Sharp brake impulses are also effected.

Upon implementation of automatic braking or in the event of the vehicle coming to a standstill in certain countries, Active Distance Assist DISTRONIC is deactivated. Depending on the respective country, the hazard warning light system is also switched on.

When the vehicle has come to a standstill:

- the vehicle is secured with the electric parking brake.
- the vehicle is unlocked.
- if possible, an emergency call is made to the Mercedes-Benz emergency call center.

Before the **Initiating Emergency Stop** message is displayed, you can cancel Active Emergency Stop Assist by turning the steering wheel.

Once the **Initiating Emergency Stop** message has been displayed, you can cancel Active Emergency Stop Assist as follows:

- **Accelerating or braking:** the emergency stop is canceled, but the warning message, warning tone and electric power steering remain active

- **Steering:** electric power steering is canceled, the warning message and warning tone remain active, and the vehicle continues to be braked
- **Steering and accelerating or braking:** the emergency stop and electric power steering are canceled. The warning message and warning tone are canceled.

For vehicles with Driver Assist Package, Active Emergency Stop Assist can be canceled in certain countries by performing one of the following actions:

- Steering and accelerating or braking
 - Deactivating Active Distance Assist DISTRONIC
- ① Active Emergency Stop Assist can initiate an emergency stop a maximum of three times within a driving cycle. After that, Active Steering Assist and Active Emergency Stop Assist are disabled until the vehicle has been restarted.

System limits

For the detection of vehicles and other obstacles, observe the system limits of the following functions:

- Active Distance Assist DISTRONIC (→ page 202)
- Active Steering Assist (→ page 212)
- Active Lane Change Assist (→ page 216)
- Active Lane Keeping Assist (→ page 230)
- Active Brake Assist (→ page 218)

The Active Emergency Stop Assist is inactive in the following case:

- Active Lane Keeping Assist and Active Steering Assist are switched off.
- Active Distance Assist DISTRONIC is switched off (country-dependent).

Active Lane Change Assist

Function of Active Lane Change Assist

Active Lane Change Assist supports the driver with lane changes by applying steering torque if the driver activates a turn signal indicator.

Observe the notes on driving systems and your responsibility; you may otherwise fail to recognize potential dangers (→ page 190).

The following conditions must be met for this function:

- You are driving on a freeway or road with multiple lanes in the direction of travel.
- The vehicle speed is between 50 mph (80 km/h) and 110 mph (180 km/h).
- A dashed boundary marking separates the adjacent lane.
- No vehicle is detected in the adjacent lane.
- Active Lane Change Assist is switched on in the multimedia system.
- Active Steering Assist is switched on and active.

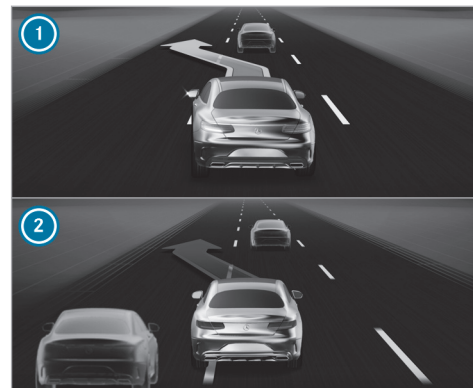

Indicator on the **Assistance** menu on the driver display

- ① Green arrow: lane change initiated
- ② Red arrow: lane change canceled

If no vehicle is detected in the adjacent lane and a lane change is permitted, the lane change will begin after the driver has activated the turn signal indicator. This will be indicated to the driver by a green flashing arrow next to the  steering

wheel symbol. A message reading **Lane Change to the Left**, for example, will also appear. If Active Lane Change Assist is activated with the turn signal indicator, but a lane change is not possible immediately, only the green flashing arrow will appear next to the  steering wheel symbol still being shown in green.

The turn signal indicator will automatically be activated as soon as lane change assistance starts.

If a lane change is not possible, the arrow will disappear after a few seconds, and a new lane change must be initiated. Lane changes can be made only immediately on freeway sections without speed limits.

In addition, a warning tone may sound, depending on the respective situation.

⚠ WARNING Risk of accident when changing lane to an occupied adjacent lane

Lane Change Assist cannot always clearly detect if the adjacent lane is free.

The lane change might be initiated although the adjacent lane is not free.

- ▶ Before changing lanes, make sure that the neighboring lane is free and there is no danger to other road users.
- ▶ Monitor the lane change.

⚠ WARNING Risk of accident if Lane Change Assist unexpectedly stops functioning

If the system limitations for Lane Change Assist have been reached, there is no guarantee that the system will remain active.

Lane Change Assist cannot then assist you by applying steering torque.

- ▶ Always monitor the lane change and keep your hands on the steering wheel. Observe the traffic conditions and steer and/or brake if necessary.

System limits

For Active Lane Change Assist, the system limits of Active Steering Assist (→ page 212) apply.

In addition, the system may be impaired or inoperative in the following situations:

- The sensors in the rear bumper are dirty, damaged or covered by a sticker or ice and snow, for example.
- The exterior lighting indicates a defect.

i Active Lane Change Assist sensors will adjust automatically over a certain distance after the vehicle has been delivered. Active Lane Change Assist will be unavailable during this teach-in process; no arrow will appear next to the  Active Steering Assist symbol when the turn signal indicator is activated.

Setting Active Lane Change Assist

Multimedia system:

  **▶▶ Settings ▶▶ Assistance**
▶▶ Driving

- ▶ Select **Active Lane Change Assist**.
- ▶ Select between the **On** or **Off** setting options.
- i** If **Active Steering Assist** has been switched off, it will not be possible to operate **Active Lane Change Assist**.

Active Brake Assist

Function of Active Brake Assist

Active Brake Assist consists of the following functions:

- Collision warning
- Autonomous braking function
- Situation-based brake force boosting
- **Vehicles with Driving Assistance Package (country-dependent):** Evasive Steering Assist or Active Evasive Steering Assist

Active Brake Assist can help you to minimize the risk of a collision with vehicles, cyclists or pedestrians, or to reduce the effects of such a collision. If Active Brake Assist has detected a risk of collision, a warning tone sounds and the Active Brake Assist lamp  lights up.

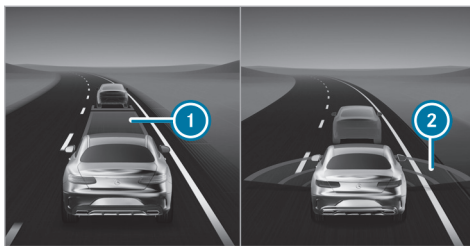

Visual on the driver display in the **Assistance** menu

- ① Distance insufficient
- ② Red radar waves

In the **Assistance** menu, an insufficient distance to the vehicle in front ① is displayed in red. If you further reduce the distance, the vehicle in front is also highlighted in red. When the system detects a risk of collision, red radar waves ② appear ahead of the vehicle.

- ① **Vehicles with PRE-SAFE®:** depending on the country, an additional haptic warning is given in the form of slight, repeated tensioning of the driver's seat belt.

If you do not react to the warning, autonomous braking can be initiated in critical situations.

In particularly critical situations, Active Brake Assist can also initiate autonomous braking directly. In this case, the warning tone and distance warning lamp  are simultaneous with the braking action.

If you apply the brakes yourself in a critical situation or apply the brakes during autonomous braking, situation-based braking assistance is given. The brake pressure increases up to maximum emergency braking if necessary.



If autonomous braking, situation-related based assistance or evasive action has occurred, pop-up

 appears on the driver display. It automatically disappears after a short time.

If the autonomous braking function or the situation-based braking assistance is triggered, additional preventive measures for occupant protection by PRE-SAFE® may also be initiated.

 **WARNING** Risk of an accident caused by limited detection performance of Active Brake Assist

Active Brake Assist cannot always clearly identify objects and complex traffic situations.

In such cases, Active Brake Assist might:

- Give a warning or brake without reason
- Not give a warning or not brake

Active Brake Assist is only an aid. The driver is responsible for maintaining a sufficiently safe distance to the vehicle in front, vehicle speed and for braking in good time.

 Always pay careful attention to the traffic situation; do not rely on Active Brake Assist alone.

 Be prepared to brake or swerve if necessary.

If Active Brake Assist is deactivated or the functions are restricted, e.g. owing to activation of another driving system, the Active Brake Assist  warning lamp appears on the driver display.

If the system is unavailable owing to soiled or damaged sensors or a malfunction, or if the functions are restricted, the Active Brake Assist  warning lamp appears on the driver display.

Also observe the system limits of Active Brake Assist.

Collision warning

The collision warning can assist you in the following situations with an intermittent warning tone and the  warning lamp:

- at speeds up to approximately 155 mph (250 km/h) when approaching moving vehicles ahead.
- at speeds up to approximately 50 mph (80 km/h) when approaching stationary vehi-

cles, pedestrians walking along the road and moving cyclists ahead.

- at speeds up to approximately 43 mph (70 km/h) when approaching crossing pedestrians and cyclists.
- at speeds up to approximately 37 mph (60 km/h) when approaching stationary pedestrians and cyclists.

Autonomous braking function

At speeds above approximately 4 mph (7 km/h), the autonomous braking function can intervene in the following situations:

- at speeds up to approximately 155 mph (250 km/h) when approaching moving vehicles ahead.
- at speeds up to approximately 50 mph (80 km/h) when approaching moving cyclists ahead, pedestrians walking along the road and stationary vehicles.
- at speeds up to approximately 43 mph (70 km/h) when approaching crossing pedestrians and cyclists.

Situation-based brake force boosting

At speeds above approximately 4 mph (7 km/h), situation-related brake force boosting can intervene in the following situations.

- at speeds up to approximately 155 mph (250 km/h) when approaching moving vehicles ahead.
- at speeds up to approximately 50 mph (80 km/h) when approaching moving cyclists ahead, pedestrians walking along the road and stationary vehicles.
- at speeds up to approximately 43 mph (70 km/h) when approaching crossing pedestrians and cyclists.
- at speeds up to approximately 37 mph (60 km/h) when approaching stationary pedestrians and cyclists.

Canceling a brake application of Active Brake Assist

You can cancel a brake application of Active Brake Assist at any time by:

- firmly depressing the accelerator pedal or by kickdown
- releasing the brake pedal.

Active Brake Assist may cancel the brake application when one of the following conditions is fulfilled:

- You steer to avoid an obstacle.
- There is no longer a risk of collision.
- An obstacle is no longer detected in front of your vehicle.

Turning maneuver function (vehicles with Driving Assistance Package):

If the system detects a risk of a collision with an oncoming vehicle when turning across an oncoming lane, autonomous braking can be initiated at speeds below 9 mph (15 km/h) before you have departed your own lane.

Evasive Steering Assist (vehicles with Driving Assistance Package only)

 Availability of this function is country-dependent.

Evasive Steering Assist has the following features:

- The ability to detect stationary or moving pedestrians.
- Help through additional steering assistance if it detects an evasive maneuver.
- Activation by an abrupt steering movement during an evasive maneuver.
- Assistance in taking evasive action, and straightening of the vehicle.
- Reaction from a speed of approximately 12 mph (20 km/h) up to a speed of approximately 43 mph (70 km/h).

You can prevent the assistance at any time by actively steering.

⚠ WARNING Risk of accident despite Evasive Steering Assist

Evasive Steering Assist cannot always recognize objects or complex traffic situations clearly.

Moreover, the steering support provided by Evasive Steering Assist is not sufficient to avoid a collision.

- ▶ Always pay careful attention to the traffic situation; do not rely on Evasive Steering Assist alone.
- ▶ Be prepared to brake or swerve if necessary.
- ▶ End the support by actively steering in non-critical situations.
- ▶ Drive at an appropriate speed if there are pedestrians close to the path of your vehicle.

Active Evasive Steering Assist

- ⓘ Availability of this function is country-dependent.

⚠ WARNING Risk of accident despite Active Evasive Steering Assist

Active Evasive Steering Assist cannot always clearly identify objects and complex traffic situations.

In such cases, Active Evasive Steering Assist may:

- issue a warning or initiate a steering intervention without reason
- fail to issue a warning or initiate a steering intervention

Active Evasive Steering Assist can help to prevent a collision by automatically initiating a steering intervention.

- ▶ Always pay close attention to the road and traffic conditions and do not rely on Active Evasive Steering Assist alone.
- ▶ Be prepared to brake or swerve if necessary.
- ▶ Adjust your speed if there are pedestrians near the vehicle.

Active Evasive Steering Assist can automatically react to objects that are stationary or moving longitudinally in your lane.

Active Evasive Steering Assist has the following features:

- Detection of pedestrians, cyclists and vehicles.
- Assistance through autonomous steering intervention during a necessary evasive maneuver
- Autonomous activation if there is sufficient space in your own lane
- Reaction from a speed of approximately 18 mph (30 km/h) up to a speed of approximately 50 mph (80 km/h).

When Active Evasive Steering Assist is intervening, and for the duration of the evasive action, a warning tone is sounded and the distance warning lamp  flashes.

The steering assistance by Active Evasive Steering Assist can be canceled at any time by steering, accelerating or braking.

222 Driving and parking

Active Evasive Steering Assist can intervene in the following speed ranges:

- when approaching stationary vehicles, pedestrians or cyclists at speeds from approximately 18 mph (30 km/h) to approximately 50 mph (80 km/h)
- when approaching pedestrians or cyclists moving longitudinally ahead at speeds from approximately 18 mph (30 km/h) to approximately 50 mph (80 km/h)

System limits

Full system performance is not yet available for a short time after switching on the vehicle or after driving off. Depending on the environmental conditions, it may take a few minutes before full system performance is available.

The system may be impaired or may not function, particularly in the following situations:

- in snow, rain, fog, heavy spray, glare, in direct sunlight or in greatly varying ambient light.
- if the sensors are soiled, fogged up, damaged or covered.

- if the sensors are impaired owing to interference from other radar sources, e.g. strong radar reflections in parking garages.
- if a loss of tire pressure or a defective tire has been detected and displayed.
- if DSR is activated.
- in complex traffic situations where objects cannot always be clearly identified.
- if pedestrians or vehicles move quickly into the sensor detection range.
- if pedestrians are hidden by other objects.
- if the typical outline of a pedestrian cannot be distinguished from the background.
- if a pedestrian is not detected as such, e.g. owing to special clothing or other objects.
- on bends with a tight radius.
- if the driver's seat belt is not fastened.
- **Active Evasive Steering Assist:** if there is no lane marking or it is not clearly recognizable
- **Active Evasive Steering Assist:** if the course of the road is nowhere near straight

- **Active Evasive Steering Assist:** if there is a trailer hooked up or a bicycle rack

Setting Active Brake Assist

Requirements:

- The vehicle is switched on.



Multimedia system:

  **» Settings » Assistance**
» Collision Avoidance

 Activate or deactivate the function.

-  It is recommended that you always leave Active Brake Assist activated.

Switching off Active Brake Assist also switches off the distance warning function, the collision warning, the autonomous braking function and Active Evasive Steering Assist (with Driving Assistance Package - country-dependent).

-  If Active Brake Assist is deactivated, the  symbol appears in the status bar of the driver display and when the vehicle is next started the system is activated again.
-  The setting after starting the vehicle depends on the country.

Setting warning timing

- ▶ Select  alongside **Active Brake Assist**.
- ▶ Select **Early**, **Medium** or **Late**.

Traffic Sign Assist

Function of Traffic Sign Assist

- ⓘ This function is an on-demand feature (→ page 25).

Traffic Sign Assist detects the traffic signs with the multifunction camera and compares them with the information from the digital road map of the navigation system. It assists you by displaying detected speed limits and overtaking restrictions on the driver display.

Speed limits can also be shown on the head-up display.

The system can issue a warning when you exceed the speed limit.

In some countries, the system can provide you with further functions and warn you when you are approaching pedestrian crossings. If the system detects that you are driving onto a section of road

in the wrong direction of travel, it will trigger a warning.

The camera also detects and analyzes traffic signs with a restriction indicated by an additional sign (e.g. in wet conditions).

Traffic Sign Assist shows only selected signs on the driver display. Actual traffic signs and speed limits have priority over traffic signs and speed limits shown on the driver display.

Observe the notes on driving systems and your responsibility; you may otherwise fail to recognize potential dangers (→ page 190).

Notes on trailer operation

- ⓘ Availability of this function is country-dependent.
- ⓘ Observe also the notes on trailer operation (→ page 266).

If a trailer or bicycle rack is connected correctly, the central display will show the query concerning the type of trailer and its maximum permissible speed (→ page 270).

It is the driver's responsibility to manually adjust the maximum permissible speed in the **small or large trailer** category.

In particular, the country-specific laws must be taken into account, e.g. regarding:

- maximum design speed or speed restriction for which the vehicle is approved
- gross vehicle weight rating with or without towing vehicle
- required number of years with a corresponding driving license
- type and condition of the road used
- the weather conditions

The maximum permissible speed adapted to the car/trailer combination can be transferred to manual or automatic speed adoption during a journey (equipment-dependent).

The system can take relevant additional signs for speed limits and clear traffic rules pertaining to the road category into account for the car/trailer combination (country-dependent).

No maximum permissible speed can be selected for a bicycle rack in the multimedia system. When using a bicycle rack, observe the specifications for the maximum permissible speed in the Operator's Manual.

Also observe the following information:

- select a speed adapted to the traffic, surroundings and weather conditions
- observe actual traffic signs
- observe applicable traffic rules and regulations

Observe the notes on driving systems and your responsibility; you may otherwise fail to recognize potential dangers (→ page 190).

Indicators on the driver display

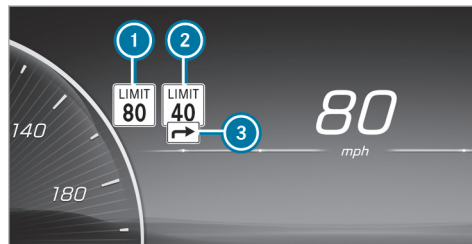

(Example)

- 1 Permissible speed
- 2 Permissible speed when there is a restriction
- 3 Additional sign with restriction

The system can show up to two traffic signs on the driver display simultaneously. The system will always prioritize displaying speed restrictions. No more than one traffic sign with a maximum permissible speed can be shown on the head-up display. If two speed signs are shown on the driver display, e.g. in the event of detected restrictions, the value of left-hand speed restriction 1 will

always be conveyed to the cruise control or Active Distance Assist DISTRONIC for acceptance and shown on the head-up display.

Important information from other systems may cause traffic signs to be hidden for a short time.

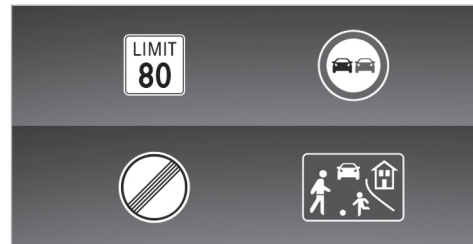

Examples of traffic signs that can be displayed

Traffic Sign Assist can detect and display the following traffic signs 1:

- speed restrictions
- end of the speed restriction
- overtaking restrictions
- play streets

- recommended speeds

Traffic Sign Assist can detect the following additional signs ③ and evaluate relevance of the restrictions as required using auxiliary vehicle sensors:

- in wet conditions
- slippery road surfaces
- in fog
- temporary restrictions
- exits
- restrictions for car/trailer combinations

① Availability of the additional character recognition function is country-dependent.

Traffic Sign Assist also uses data from the digital street map in the navigation system. When you pass a city or city boundary or move from one road onto another, e.g. when joining or exiting a freeway, or when turning at a crossroads, the view on the driver display can thus also be updated without a traffic sign having been detected.

① Regularly update the digital road map of the navigation system to enable Traffic Sign Assist to work optimally.

Depending on vehicle equipment and country, the system can also display speed limits ahead on the driver display and head-up display. The driver display can also show the distance to an upcoming lower speed limit. Information from the digital road map of the navigation system is used for this purpose. The **Assistance** menu can also display a dynamic visualization of the speed limit ahead.

If the Traffic Sign Assist cannot determine the current maximum permissible speed, e.g. due to a lack of signage, the following indicator will appear on the driver display:



Traffic Sign Assist is not available in all countries. This display will be shown permanently in the vehicle when you are traveling in countries where Traffic Sign Assist is not supported.

If the system is temporarily or permanently unavailable due to a technical malfunction or dirt on the windshield, a corresponding display message will appear on the driver display. The Traffic Sign Assist  warning lamp will also light up on the driver display in certain countries.

① Please also note the information on the display messages from Traffic Sign Assist (→ page 419).

Warning when the maximum permissible speed is exceeded

The system can warn you if you are about to exceed the maximum permissible speed. Depending on the country, you can set in the multimedia system by how much the maximum permitted speed may be exceeded before a warning is given. You can switch off the warning or set whether the warning should be visual (by flashing the traffic sign on the driver's display) or visual and audible. Depending on the country, the selection of the type of warning will be confirmed by an indicator on the driver display.

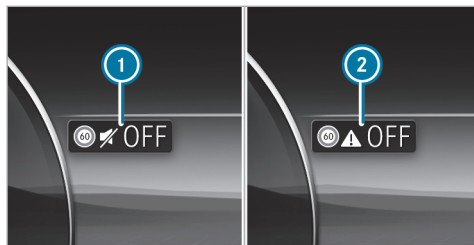

(Example)

- ① Visual warning only
- ② WARNING off

- ① The type, duration and deployment thresholds of the speed warning as well as the possibility of setting the deployment thresholds from which the warning is to be triggered are subject to the country-specific legislation of the country in which the vehicle is delivered.

Additional functions of Traffic Sign Assist (country-specific)

Warning for no-entry signs: Traffic Sign Assist can warn you if you drive the wrong way down a sec-

tion of road, such as on freeway on-ramps or one-way streets.

Warning at pedestrian crossings: if you are approaching a pedestrian crossing and pedestrians are in the danger zone or are moving towards it, Traffic Sign Assist can warn you up to a speed of approximately 44 mph (70 km/h).

System limits

The system may be impaired or inoperative in the following situations in particular:

- If visibility is poor, e.g. due to insufficient illumination of the road, highly variable shade conditions, rain, snow, fog, swirling dust or heavy spray.
- if there is glare, e.g. from oncoming traffic, direct sunlight or reflections.
- If there is dirt on the windshield in the vicinity of the multifunction camera or if the camera is fogged up, damaged or obscured.
- If the traffic signs are difficult to see because, for example, they are dirty, obscured, faded, iced over, damaged, inconveniently positioned, insufficiently illuminated or twisted.
- Active traffic signs with LED displays may not be detected correctly or at all due to technical factors, such as transmission frequency.
- If the information on the navigation system's digital map is incorrect, incomplete or out of date.
- If the signs, road markings or road layout are ambiguous, e.g. in the case of traffic signs at road work sites, at on-ramps and off-ramps, in the case of adjacent lanes or parallel roads or where there are pedestrian crossing markings at traffic lights.
- If the signage or road markings do not comply with the standard.
- If the signage, road markings or road guidance is country-specific and deviates from the route guidance of the navigation system, e.g. at or after road work sites.
- After sharp turns and tight bends, if traffic signs are outside the camera's field of vision.
- If you overtake vehicles with traffic signs attached to them.

- If you are using transportation equipment secured to the vehicle with a trailer coupling, such as a bicycle rack, restrictions for car/trailer combinations may be considered valid.

Setting Traffic Sign Assist

Multimedia system:

- 
 ►► Settings ►► Assistance
 ►► Assistance ►► Traffic Sign Assist

Activating or deactivating the speed limit warning

- ▶ Switch off **Speed Limit Warning**. Following country-specific legislation, the speed limit warning remains deactivated until the next time the vehicle is switched on or off and the driver's door is opened (depending on the respective equipment).

Change the type of speed limit warning

- ▶ Change the warning to **Visual** or **Visual & Audible**.

Setting the warning threshold

This value determines the speed at which a warning is issued when exceeded.

- ▶ Set the desired speed under **Warning Threshold**.

Activating or deactivating additional functions of Traffic Sign Assist

- ▶ Activate or deactivate **Further Warnings**. The available functions are switched on or off.

Set the type of warning for other functions

- ▶ Select **Visual** or **Visual & Audible**.

Blind Spot Assist and Active Blind Spot Assist

Function of Blind Spot Assist and Active Blind Spot Assist with exit warning

Blind Spot Assist and Active Blind Spot Assist use two lateral, rear-facing radar sensors to monitor the area up to 130 ft (40 m) behind and 10 ft (3 m) next to your vehicle.

If a vehicle is detected at speeds above approximately 8 mph (12 km/h) and this vehicle subsequently enters the monitoring range directly next to your vehicle, the warning lamp in the outside mirror lights up red.

Status display in the driver's display



Gray: the system is activated but inoperative.



Green: the system is activated and operational.

If a vehicle is detected close to your vehicle and you switch on the turn signal indicator in the corresponding direction, a double warning tone will sound and the red warning lamp in the outside mirror will flash. If the turn signal indicator remains switched on, all other detected vehicles are indicated only by the flashing of the red warning lamp.

If you overtake a vehicle quickly, no warning is given.



WARNING Risk of accident despite Blind Spot Assist

Blind Spot Assist does not react to vehicles approaching and overtaking you at a greatly different speed.

Blind Spot Assist cannot warn drivers in this situation.

- ▶ Always pay careful attention to the traffic situation and maintain a safe distance at the side of the vehicle.

⚠ WARNING Risk of accident despite Active Blind Spot Assist

Active Blind Spot Assist does not react to the following:

- if you overtake a vehicle too closely so that it is in the blind spot area
- if vehicles traveling at a much faster speed approach and then overtake

Active Blind Spot Assist may not give warnings or intervene in such situations.

- ▶ Always pay careful attention to the traffic situation and maintain a safe distance at the side of the vehicle.

Observe the notes on driving systems and your responsibility; you may otherwise fail to recognize dangers (→ page 190).

Exit warning

The exit warning is an additional function of Blind Spot Assist and can warn vehicle occupants about approaching vehicles when leaving the vehicle when stationary.

⚠ WARNING Risk of accident despite exit warning

The exit warning neither reacts to stationary objects nor to persons or road users approaching you at a greatly differing speed.

The exit warning cannot warn drivers in these situations.

- ▶ Always pay particular attention to the traffic situation when opening the doors and make sure there is sufficient clearance.

If there is a vehicle in the monitoring range, this is indicated in the outside mirror. If a vehicle occupant opens the door on the side with the warning, a warning tone sounds and the warning lamp in the outside mirror starts to flash.

This additional function is available only when Blind Spot Assist is active. When the exit warning is activated, it can warn vehicle occupants for up to three minutes after switching the vehicle off. The exit warning is no longer available once the warning lamp in the outside mirror flashes three times.

The exit warning is only an aid and not a substitute for the attention of vehicle occupants. The responsibility for opening and closing the doors and for leaving the vehicle remains with the vehicle occupants.

System limits

Blind Spot Assist and Active Blind Spot Assist may be limited in the following situations, in particular:

- if there is dirt on the sensors or the sensors are obscured
- in poor visibility, e.g. due to fog, heavy rain or snow
- if there are narrow vehicles, e.g. bicycles or motorbikes
- if the road has very wide or narrow lanes

- if vehicles are not driving in the middle of their lane

Warnings may be issued in error when driving close to crash barriers or similar continuous lane borders. Always make sure that there is sufficient distance to the side for other traffic or obstacles.

Warnings may be interrupted when driving alongside long vehicles, for example trucks, for a prolonged time.

Blind Spot Assist is not operational when reverse gear is engaged.

Blind Spot Assist and the exit warning are not operational when a trailer is coupled to the vehicle and the electrical connection has been correctly established.

The exit warning may be limited in the following situations:

- when the sensors are covered by adjacent vehicles in narrow parking spaces
- when people approach the vehicle
- in the event of stationary or slowly moving objects

Brake application function in Active Blind Spot Assist

- ① The brake application function is available for vehicles with Driving Assistance Package, depending on the country.

If Active Blind Spot Assist detects a risk of a side impact in the monitored range, a course-correcting brake application is carried out. Course-correcting brake application helps in this case to avoid collision with another vehicle.

The course-correcting brake application is available to you from a speed of approx. 20 mph (30 km/h) - 17 mph (60 km/h) (depending on the country) up to a speed of approx. 125 mph (200 km/h).

⚠ WARNING Risk of accident despite brake application of Active Blind Spot Assist

A course-correcting brake application cannot always prevent a collision.

- ▶ Always steer, brake or accelerate yourself, especially if Active Blind Spot Assist

warns you or makes a course-correcting brake application.

- ▶ Always maintain a safe distance at the sides.



If a course-correcting brake application occurs, the red warning lamp flashes in the outside mirror and a warning tone sounds. In addition, a display ① indicating the danger of a side collision appears on the driver display.

In rare cases, the system may make an inappropriate brake application. This brake application may be interrupted at any time if you steer slightly in the opposite direction or accelerate.

System limits

Note the system limitations of Active Blind Spot Assist; you may otherwise not recognize the dangers (→ page 227).

Either a course-correcting brake application appropriate to the driving situation, or none at all, may occur in the following situations in particular:

- Vehicles or obstacles, e.g. crash barriers, are located on both sides of your vehicle.
- An approaching vehicle leaves too little lateral distance between you.
- You have adopted a sporty driving style with high cornering speeds.
- You brake or accelerate significantly.
- A driving safety system intervenes, e.g. ESP® or Active Brake Assist.
- ESP® is deactivated.
- A loss of tire pressure or a defective tire is detected.
- Transport equipment, e.g. a trailer or bicycle rack, is attached to the trailer coupling and

the electrical connection has been correctly established.

Switching Blind Spot Assist or Active Blind Spot Assist on or off

Multimedia system:

→  >> Settings >> Assistance
>> Collision Avoidance

- ▶ Activate or deactivate **Active Blind Spot Assist**.

Active Lane Keeping Assist

Function of Active Lane Keeping Assist

Active Lane Keeping Assist monitors the area in front of your vehicle using the multifunction camera (→ page 191).

It can protect you against unintentionally departing your lane. The system can guide you back into your lane with course-correcting steering intervention, and also warn you with tangible steering wheel feedback.

Active Lane Keeping Assist is available in the speed range between 37 mph (60 km/h) and

124 mph (200 km/h) or up to 130 mph (210 km/h) depending on the country.

The system can intervene if the following conditions are met:

- Active Lane Keeping Assist detects a lane marking.
- You touch this lane marking with one of your front wheels.

If you activate the turn signal indicator, no steering intervention will occur on the corresponding side.

If you leave your lane without activating a turn signal indicator, but danger of a collision with a moving obstacle in your lane is detected, no steering intervention will occur.

Vehicles with Blind Spot Assist or Driving Assistance Package: If the system detects an obstacle, e.g. another vehicle, in the adjacent lane, steering intervention will occur despite the turn signal indicators.



In the following cases, indicator ❶ will appear on the driver display and a warning tone will sound:

- Steering intervention by Active Lane Keeping Assist lasts longer than approximately ten seconds.
- Two or more steering interventions by the system take place within approximately three minutes, without steering intervention by the driver.

You can set the sensitivity of the system in the Active Lane Keeping Assist settings in order to determine the level of assistance. You can also determine whether the system is to react to

dashed lane markings, or only to solid lane markings (→ page 232).

Status indicators of Active Lane Keeping Assist



White: Active Lane Keeping Assist is switched off.

If ESP® is switched off or a tire pressure loss warning is indicated, Active Lane Keeping Assist will automatically be switched off.



Yellow: There is a malfunction. Also note any display messages.



Gray: Active Lane Keeping Assist is switched on but not ready.



Green: Active Lane Keeping Assist is switched on and ready.



Red: Active Lane Keeping Assist has guided you back into your lane with course-correcting steering intervention. If a haptic warning is also given through the steering wheel, the status indicator will flash. The lane marking on the relevant side will be shown in red.



Indicator on the [Assistance](#) menu on the driver display

If one of your front wheels moves onto a detected lane marking, this will be highlighted in red on the [Assistance](#) menu on the driver display.

System limits

In the following situations, there may be no course-correcting steering intervention, but a warning may be issued through the steering wheel depending on the situation:

- if you clearly and actively steer, brake or accelerate

- if a driving safety system is intervening, e.g. ESP® or Active Brake Assist
- if you have adopted a sporty driving style with high cornering speeds or high rates of acceleration
- if transport equipment, e.g. a trailer or bicycle rack, is attached to the trailer hitch and the electrical connection has been correctly established

The system may be impaired or inoperative in the following situations in particular:

- in poor visibility, e.g. owing to insufficient road illumination, highly variable shadows, rain, snow, fog or heavy spray
- if there is glare, e.g. from oncoming traffic, direct sunlight or reflections
- if there is dirt on the windshield in the vicinity of the multifunction camera, or if the camera is fogged up, damaged or obscured
- if there is dirt on the bumper in the area of the radar sensors, or if they are damaged or obscured

- if there are no lane markings, or several unclear lane markings are present for one lane, e.g. around road work sites
- if the lane markings are worn, dark or covered up
- if the distance to the vehicle in front is too short and the lane markings can therefore not be detected
- if the lane markings change quickly, e.g. lanes branch off, cross one another or merge
- if the lanes are very narrow and winding

Observe the notes on driving systems and your responsibility; you may otherwise fail to recognize potential dangers (→ page 190).

■ Activating/deactivating Active Lane Keeping Assist

Multimedia system:

- ➔  ➔ Settings ➔ Assistance
- ➔ Collision Avoidance
- ➔ Active Lane Keeping Assist
- ▶ Activate or deactivate the function.

Alternatively, Active Lane Keeping Assist can be activated and deactivated via the quick vehicle access .

- ⓘ The settings after the vehicle is started are country-specific.

■ Setting Active Lane Keeping Assist

Multimedia system:

- ➔  ➔ Settings ➔ Assistance
- ➔ Collision Avoidance
- ➔ Active Lane Keeping Assist

Setting the sensitivity

- ▶ Select .
- ▶ Select **Early**, **Med.** or **Late**.

The last setting selected will be applied the next time the vehicle is started.

- ⓘ The standard setting of this function is country-dependent.
- ⓘ The function may not be available on vehicles with Driving Assistance Package, depending on the country.

Activating/deactivating assistance when lane markings are interrupted

- ▶ Select **Advanced Support**.

The last setting selected will be applied the next time the vehicle is started.

- ⓘ The standard setting of this function is country-dependent.
- ⓘ Depending on the country, this function must be activated in order for the full scope of Emergency Stop Assist to be available. Further information on Emergency Stop Assist (→ page 214).

AIRMATIC

Function of AIRMATIC

! NOTE Mercedes-AMG vehicles

- ▶ Observe the notes in the Supplement. You could otherwise fail to recognize dangers.

AIRMATIC is an air suspension system with variable damping for improved driving comfort. The all-round level control system ensures the best possible suspension and a consistent level of ground clearance, even with a loaded vehicle. When driving at speed, the vehicle is lowered automatically to improve driving safety and reduce energy consumption. You also have the option of manually adjusting the vehicle level.

AIRMATIC comprises the following functions and components:

- Air suspension with automatic all-round level control
- Speed-dependent lowering of the vehicle level
- A higher vehicle level can be selected for greater ground clearance using the vehicle level button (rocker switch )
- ADS PLUS (adaptive damping system with constant adjustment of damping characteristics)

Suspension setting and vehicle level per drive program

Drive programs **C** and **E**

- Comfortable suspension tuning
- The vehicle is set to normal level
- Lowers the vehicle to low level -1 from a speed of approx. 87 mph (140 km/h)
- Raises the vehicle to normal level below a speed of approx. 25 mph (40 km/h)

Drive program **S**

- Firmer suspension tuning
- The vehicle is set to low level -1 with no speed-dependent lowering of the vehicle

Drive program 

- Suspension tuning for off-road driving
- Raises the vehicle at speeds below approx. 37 mph (60 km/h) to off-road level +1
- from a speed of approx. 50 mph (80 km/h): lowers the vehicle to normal level and

234 Driving and parking

below a speed of approx. 30 mph (45 km/h):
raises the vehicle again to off-road level +1

- above a speed of approx. 68 mph (110 km/h),
switching to 



Individual suspension settings can be called up in
drive program  (→ page 173).

When the entry/exit level is activated, the vehicle
is lowered to low level -2 to facilitate getting
into/out of the vehicle. When driving at speeds of
approximately 19 mph (30 km/h) or above, the
entry/exit level is deactivated and the vehicle is
raised (→ page 236).

When Car Wash Mode is activated, the vehicle is
raised to a noticeably higher level for automatic
car washes. When driving at speeds of approx-
imately 12 mph (20 km/h) or above, the Car
Wash Mode is deactivated and the vehicle is
raised to the level set previously (→ page 340).

At speeds below approx. 37 mph (60 km/h), you
can also manually raise the vehicle to off-road
level +1 (→ page 234)

- ① **Operation with a trailer or bicycle rack:** if
transport equipment such as a trailer or a

bicycle rack is attached to the trailer coupling
and the electrical connection has been cor-
rectly established, the vehicle remains at nor-
mal level in all driving modes except . In
drive program  the vehicle is lowered to
normal level from a speed of approx. 19 mph
(30 km/h).

Differences between different vehicle levels com-
pared to normal level

- **Car wash level:**
 - Approx. +3.5 in (+90 mm)
- **Off-road level +1:**
 - Approx. +2.0 in (+50 mm)
- **Low level -1:**
 - Approx. -0.6 in (-15 mm)
- **Low level -2 or entry/exit level:**
 - Approx. -1.0 in (-25 mm)

- ① Car wash level is 1.5 in (40 mm) higher than
the maximum vehicle level (off-road level +1).
Observe the noticeably increased height of
the vehicle in car wash mode particularly

when driving into underground car parks in
order to avoid potential damage.

System limits

AIRMATIC may not be available or have only limi-
ted availability in the following cases:

- The overheating protection has been activated
due to frequent height adjustments within a
short time. A corresponding display message
appears in the driver display.
After the cooling phase, the system is again
available without restriction.

■ Setting the vehicle level (vehicles with AIR- MATIC)

 **WARNING** Risk of accident because vehi-
cle level is too high

Driving characteristics may be impaired.

The vehicle can drift outwards, for example,
when steering or cornering.

- ▶ Choose a vehicle level which is suited to
the driving style and the road surface
conditions.

⚠ WARNING Risk of becoming trapped due to the vehicle lowering

When lowering the vehicle, other people could become trapped if their limbs are between the vehicle body and the wheels or underneath the vehicle.

- ▶ Make sure nobody is underneath the vehicle or in the immediate vicinity of the wheel arches when you lower the vehicle.

⚠ WARNING Risk of becoming trapped due to the vehicle lowering

Vehicles with AIRMATIC or level control: when you unload luggage or leave the vehicle, the vehicle first rises slightly and then returns to the set level shortly afterwards.

You or anyone else in the vicinity of the wheel arches or the underbody could thus become trapped.

The vehicle can also be lowered after being locked.

- ▶ When leaving the vehicle, make sure that nobody is in the vicinity of the wheel arches or the underbody.

! NOTE Damage due to vehicle lowering

Parts of the body could be damaged when the vehicle is lowered.

- ▶ Make sure that there are no obstacles such as curbs underneath or in the immediate vicinity of the body when the vehicle is being lowered.

! NOTE Mercedes-AMG vehicles

- ▶ Observe the notes in the Supplement. You could otherwise fail to recognize dangers.

Requirements

- The vehicle has been started.
- The vehicle is not moving faster than 37 mph (60 km/h).
- **Operation with trailer or bicycle rack when the trailer socket is connected correctly:**

- The vehicle is not moving faster than 19 mph (30 km/h).

- ⓘ Use normal level when towing a trailer. High-level driving is not permitted in trailer operation on public roads.

Raising the vehicle

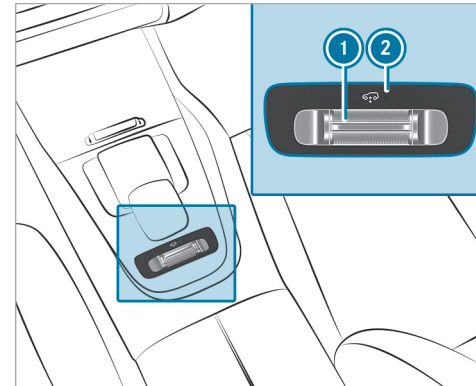

- ▶ Push rocker switch ① forward. Indicator lamp ② flashes while the vehicle is being raised to off-road level +1 and remains lit when the raising process is complete.

Off-road level +1 set remains stored even after the vehicle has been switched off.

The vehicle is lowered again to the vehicle level of the selected drive program in the following situations:

- When driving faster than 50 mph (80 km/h).
- When driving briefly between 40 mph (65 km/h) and 50 mph (80 km/h).
- You select another drive program.

Lowering the vehicle

- ▶ Pull rocker switch ①. The vehicle is lowered to the height of the selected drive program. Indicator lamp ② flashes during lowering and goes out when the lowering process is complete.

Setting the entering and exiting level (AIR-MATIC)

Requirements

- The vehicle has been started.
- The vehicle is moving at speeds below 20 mph (30 km/h).

Multimedia system:

→  **Settings** **Quick access**

- ▶ Select **Lower When Getting In On**. The vehicle is lowered to low level -2 to facilitate entering and exiting. The selection is stored and the entry/exit level remains stored even after the vehicle is switched off.

In the following situations, the vehicle will be raised to the currently selected vehicle level:

- **Entry/Exit Lowering OFF** is selected.
- After restarting, the vehicle is moving faster than 20 mph (30 km/h).

- ① The availability of this function depends on the vehicle equipment.

- ① Further information on AIRMATIC (→ page 233).

Lowering and raising the rear of the vehicle

⚠ WARNING Risk of becoming trapped due to the vehicle lowering

When lowering the vehicle, other people could become trapped if their limbs are between the vehicle body and the wheels or underneath the vehicle.

- ▶ Make sure nobody is underneath the vehicle or in the immediate vicinity of the wheel arches when you lower the vehicle.

Requirements

- all vehicle doors are closed
- there is no trailer coupled
- there is no bicycle rack installed
- the battery is sufficiently charged (if necessary, start the vehicle)

Lowering the rear of the vehicle

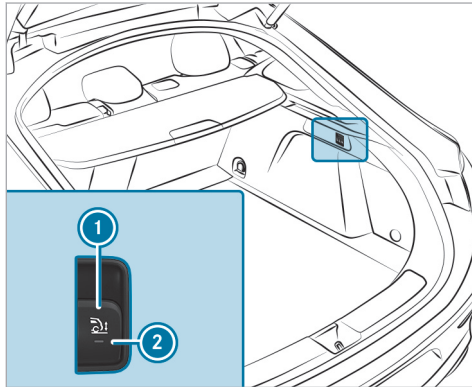

- ▶ Apply the electric parking brake.
- ▶ Shift the transmission to position **P** (→ page 176).
- ▶ Pull switch ① in the load compartment trim briefly. Indicator lamp ② flashes until the vehicle has been lowered.

The vehicle is lowered at the rear axle by approx. 1.5 in (40 mm). When the vehicle has been lowered, indicator lamp ② remains lit.

Lowering is interrupted in the following situations:

- a vehicle door is opened.
 - switch ① is pulled again.
 - the vehicle is being driven faster than 1.2 mph (2 km/h).
- ⓘ The vehicle is automatically set to the level of the drive program selected if you drive at speeds greater than 1.2 mph (2 km/h).

If indicator lamp ② flashes twice and the rear of the vehicle does not lower:

- ▶ Make sure that the requirements are met.
- ⓘ Lowering the rear of the vehicle allows the vehicle to be loaded more easily. Observe the notes on loading the vehicle when doing this (→ page 113).

Raising the rear of the vehicle

- ▶ Check if the battery is sufficiently charged. Start the vehicle, if necessary.

- ▶ Pull switch ① briefly. Indicator lamp ② goes out.

The vehicle will be raised to the currently selected level.

- ⓘ The vehicle is automatically set to the level of the drive program selected if you drive at speeds greater than 1.2 mph (2 km/h).

If the vehicle cannot be raised:

- ▶ Make sure the battery is sufficiently charged; if necessary, start the vehicle. The raising process continues.

E-ACTIVE BODY CONTROL

Function of E-ACTIVE BODY CONTROL

! NOTE Mercedes-AMG vehicles

- ▶ Observe the notes in the Supplement. You could otherwise fail to recognize dangers.

E-ACTIVE BODY CONTROL is an electrohydraulic suspension system with variable damping for

improved driving comfort. The all-round level control system ensures the best possible suspension and constant ground clearance, even with a laden vehicle. When driving at speed, the vehicle is lowered automatically to improve driving safety and reduce energy consumption. The suspension setting is adjusted depending on the road condition, vehicle load and the drive program selected. You also have the option of manually adjusting the vehicle level.

The ROAD SURFACE SCAN function detects areas of unevenness in the road before you drive over them by means of a multifunction camera. This reduces chassis movements.

The damping is adjusted individually to each wheel and depends on the following factors:

- Driving style, e.g. sporty
- Road condition, e.g. bumps
- Drive program

E-ACTIVE BODY CONTROL is comprised of the following functions and components:





- **Vehicles with Driving Assistance Package:** ROAD SURFACE SCAN

- Curve inclination function CURVE
- Recovery mode
- Individual wheel control
- Air suspension with automatic level control
- Speed-dependent lowering of the vehicle level
- A higher vehicle level can be selected for greater ground clearance using the vehicle level button (rocker switch )
- ADS PLUS (adaptive damping system with constant adjustment of damping characteristics)

Suspension setting and vehicle level per drive program

Drive programs ,  and 

- Comfortable suspension tuning
- The vehicle is set to normal level
- Lowers the vehicle to low level -1 from a speed of approx. 87 mph (140 km/h)
- Raises the vehicle to normal level below a speed of approx. 25 mph (40 km/h)
- ROAD SURFACE SCAN deactivated ()

- ROAD SURFACE SCAN active (, )
- curve inclination function deactivated (, )
- curve inclination function active ()

Drive program 

- Firmer suspension tuning
- The vehicle is set to low level -1
- No speed-dependent lowering of the vehicle
- ROAD SURFACE SCAN deactivated
- Curve inclination function deactivated

Drive program 

- Suspension tuning for off-road driving
- raising the vehicle at speeds below approx. 37 mph (60 km/h) to off-road level +1
- From a speed of approx. 50 mph (80 km/h): lowers the vehicle to normal level and below a speed of approx. 30 mph (45 km/h): raises the vehicle again to off-road level +1
- above a speed of approx. 68 mph (110 km/h), switching to 

- ROAD SURFACE SCAN active
- Curve inclination function deactivated
- Recovery mode and individual wheel control possible



Individual suspension settings can be called up in drive program  (→ page 173).

When the entry/exit level is activated, the vehicle is lowered to low level -2 to facilitate entering/exiting the vehicle. When driving at speeds of approximately 19 mph (30 km/h) or above, the entry/exit level is deactivated and the vehicle is raised (→ page 236).

When car wash mode is activated, the vehicle is raised to a noticeably higher level for automatic car washes. When driving at speeds of approximately 12 mph (20 km/h) or above, the Car wash mode is deactivated and the vehicle is raised to the level set previously (→ page 340).

At speeds below approx. 37 mph (60 km/h), you can also manually raise the vehicle to off-road level +1 (→ page 234)

- ⓘ **Operation with a trailer or bicycle rack:** if transport equipment, such as a trailer or a

bicycle rack, is attached to the trailer hitch and the electrical connection has been correctly established, the curve inclination function is deactivated and the vehicle always remains at normal level in all drive programs with the exception of . In drive program  the vehicle is lowered to normal level from a speed of approx. 19 mph (30 km/h).

Differences between different vehicle levels compared to the normal level:

- **Car wash level:**
 - Approx. +3.5 in (+90 mm)
 - **Off-road level +1:**
 - Approx. +2.0 in (+50 mm)
 - **Low level -1:**
 - Approx. -0.6 in (-15 mm)
 - **Low level -2 or entry/exit level:**
 - Approx. -1.0 in (-25 mm)
- ⓘ Car wash level is 1.5 in (40 mm) higher than the maximum vehicle level (off-road level +1). Observe the noticeably increased height of the vehicle in car wash mode particularly

when driving into underground car parks in order to avoid potential damage.

System limits

E-ACTIVE BODY CONTROL may not be available or have only limited availability in the following cases:

- The overheating protection has been activated due to frequent height adjustments within a short time. A corresponding display message appears in the driver display.
After the cooling phase, the system is again available without restriction.

Function of ROAD SURFACE SCAN

ⓘ This function is not available in all countries. The ROAD SURFACE SCAN function monitors the road in front of your vehicle using a multifunction camera (→ page 191). ROAD SURFACE SCAN detects unevenness in the road surface, e.g. bumps, before the vehicle drives over them. Chassis movements are reduced, and driving comfort is increased.

ROAD SURFACE SCAN is automatically activated if the following conditions are met:

- The drive program **C**, **CV** or  is selected.
- No terrain level +3 or car wash level is set.
- You are driving at a speed between 4 mph (7 km/h) and 99 mph (160 km/h).

System limits

ROAD SURFACE SCAN can be impaired or inoperative in the following situations:

- If the road is insufficiently lit, e.g. at night.
- In snow, rain, fog, heavy spray, glare, in direct sunlight or in varying ambient light.
- If the windshield in the area of the multifunction camera is dirty, fogged up, damaged or covered.
- If the road surface has no optic structure or reflects light.
- If you are driving too close to the vehicle in front.

- If sections of the route have a very small radius of curvature.
- During abrupt driving maneuvers, e.g. heavy braking or sudden acceleration.

Observe the notes on cleaning the multifunction camera (→ page 343).

Function of recovery mode

⚠ WARNING Risk of injury due to the vehicle moving up and down

During recovery mode, the vehicle moves up and down and can cause injuries.

▶ When activating recovery mode, make certain that no one is in the vicinity of the vehicle.

! NOTE Risk of damage due to the vehicle moving up and down

When recovery mode is activated, the vehicle springs back in and out automatically and thus moves up and down. Bottoming out can damage the underbody.

▶ Make sure that when recovery mode is activated, there is sufficient ground clearance.

Recovery mode is a function of the suspension which can assist the driver on loose surfaces (e.g. sand, snow) when freeing a vehicle which has become stuck.

The vehicle body rocks in slow, vertical motions when recovery mode has been activated. This temporarily puts the wheels under greater load, which means they have increased traction and the vehicle is freed.

You can activate free driving mode via Off-road Assist (→ page 296).

Function of individual wheel control

⚠ WARNING Risk of becoming trapped due to the vehicle lowering

The vehicle can be lowered when the individual wheel control function has been activated. Body parts could become trapped if they are

between the vehicle body and the tires or underneath the vehicle.

- ▶ Make sure that nobody is under the vehicle or in the immediate vicinity of the wheel arches when individual wheel control is activated.

! **NOTE** Risk of damage due to the vehicle moving up and down

The vehicle can be lowered or raised on one or more wheels when the individual wheel control function has been activated. Vehicle parts could be damaged due to contact with objects.

- ▶ Make sure that the vehicle has sufficient room to move when the individual wheel control function has been activated.

Individual wheel control is a function of the suspension, which can be used to set the vehicle level for each wheel individually. This can help to improve alignment of the body when driving off-road.

You can activate individual wheel control via Off-road Assist (→ page 296).

■ Adjusting the vehicle level (vehicles with E-ACTIVE BODY CONTROL)

! **WARNING** Risk of accident because vehicle level is too high

Driving characteristics may be impaired.

The vehicle can drift outwards, for example, when steering or cornering.

- ▶ Choose a vehicle level which is suited to the driving style and the road surface conditions.

! **WARNING** Risk of becoming trapped due to the vehicle lowering

When lowering the vehicle, other people could become trapped if their limbs are between the vehicle body and the wheels or underneath the vehicle.

- ▶ Make sure nobody is underneath the vehicle or in the immediate vicinity of the

wheel arches when you lower the vehicle.

! **WARNING** Risk of becoming trapped due to the vehicle lowering

Vehicles with AIRMATIC or level control: when you unload luggage or leave the vehicle, the vehicle first rises slightly and then returns to the set level shortly afterwards.

You or anyone else in the vicinity of the wheel arches or the underbody could thus become trapped.

The vehicle can also be lowered after being locked.

- ▶ When leaving the vehicle, make sure that nobody is in the vicinity of the wheel arches or the underbody.

! **NOTE** Damage due to vehicle lowering

Parts of the body could be damaged when the vehicle is lowered.

- ▶ Make sure that there are no obstacles such as curbs underneath or in the immediate vicinity of the body when the vehicle is being lowered.

Requirements:

- The vehicle has been started.
- The vehicle is not moving faster than 37 mph (60 km/h).
- **Operation with trailer or bicycle rack when the trailer socket is connected correctly:**
 - The vehicle is not moving faster than 19 mph (30 km/h).

- ⓘ Use normal level in trailer operation. High-level driving is not permitted in trailer operation on public roads.

Raising the vehicle

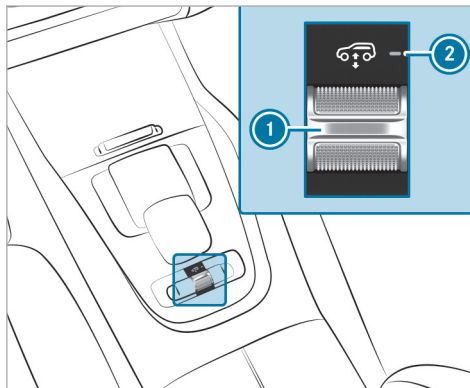

- ▶ Push rocker switch ① forwards. Indicator lamp ② flashes while the vehicle is being raised to off-road level +1 and lights up continuously when the raising process is complete.

The selected Off-road level +1 remains active even after the vehicle is switched off.

The vehicle is lowered again to the vehicle level of the selected drive program in the following situations:

- When driving faster than 50 mph (80 km/h).
- When driving briefly between 40 mph (65 km/h) and 50 mph (80 km/h).
- You select another drive program.

Lowering the vehicle

- ▶ Pull rocker switch ①. The vehicle is lowered to the height of the selected drive program. Indicator lamp ② flashes when lowering and disappears when the lowering process is complete.

Rear view camera

Function of the rear-view camera

The rear-view camera serves solely as an aid. It is not a substitute for you having to pay attention to your surroundings. The responsibility for safe maneuvering and parking remains with you. Ensure that there are no persons, animals or

objects etc. in the maneuvering area while you are maneuvering and parking.

- ① The area behind the vehicle is displayed as a mirror image, as it would appear in the rear-view mirror.

Vehicles with Parking Package

The following camera perspectives are available on the central display:

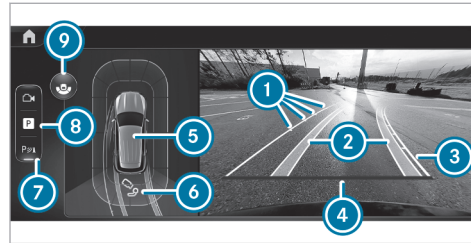

Camera Views menu (example)

- ① Guide lines at a distance of approximately 1.6 ft (0.5 m), 3.3 ft (1.0 m), 5 ft (1.5 m) and 9.9 ft (3.0 m) from the rear area
- ② Path indicating the route the wheels will take at the current steering angle (dynamic)
- ③ Area that will be driven over based on the current steering angle (dynamic)
- ④ Guide line at a distance of approximately 1.0 ft (0.3 m) from the rear area
- ⑤ Warning indicator for Parking Assist PARKTRONIC (→ page 251)
- ⑥ Trailer view (depending on the respective equipment) or rear-view camera

- ⑦ Activating/deactivating Parking Assist PARKTRONIC (→ page 254)

- ⑧ Parking Assistance menu

- ⑨ Wide-angle view

- ① When Active Parking Assist is active, paths ② will be displayed in green (→ page 255).



Wide-angle view (example)

- ⑤ Warning indicator for Parking Assist PARKTRONIC (→ page 251)

- ⑦ Activating/deactivating Parking Assist PARKTRONIC (→ page 254)

- ⑩ Standard view

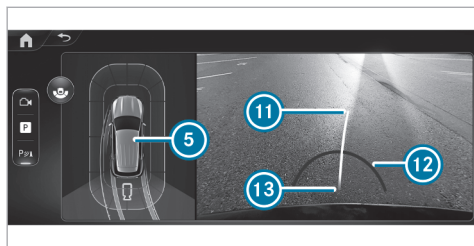

Trailer view (example)

- ⑤ Warning indicator for Parking Assist PARKTRONIC (→ page 251)
- ⑪ Yellow guide line, locating aid
- ⑫ Red guide line at a distance of approximately 1.0 ft (0.3 m) from the ball head of the trailer hitch
- ⑬ Ball head of the trailer hitch

System limits

If the system is not ready for operation, a message reading **System Inoperative** will appear on the driver display and/or on the central display.

If a camera perspective is selected and the central display is temporarily black or does not show

a camera image, the camera system is also faulty or is not ready for operation.

⚠ WARNING Risk of accident due to functional limitations of the rear-view camera

Functional limitations of the rear-view camera could lead to a risk of collision with persons or objects.

- ▶ Do not use the rear-view camera if its functions are limited.
- ▶ Ensure that no persons, animals, objects, etc. are in the maneuvering area while maneuvering and parking.

The rear-view camera will not function or will function only partially in the following situations:

- You are driving forwards at a speed greater than approximately 10 mph (16 km/h).
- The tailgate is open.
- The weather conditions are poor, e.g. heavy rain, snow, fog, storm or spray.
- The ambient light is poor, e.g. at night or if a light is shining into the camera.

- The camera lens is obstructed, dirty or fogged up. Observe the notes on cleaning the rear-view camera (→ page 343).
- The camera or rear of your vehicle is damaged. In this case, have the camera, its position and its settings checked at a qualified specialist workshop.

The field of vision and other functions of the camera system may be restricted due to additional vehicle attachments (e.g. license plate bracket or bicycle rack).

- ① The display contrast may be impaired by direct sunlight or by other light sources, e.g. when you are driving out of a garage. Particular attention should be afforded in these conditions.
- ① Have the display repaired or replaced if, for example, its use is considerably restricted due to pixel errors.

Also observe the information on vehicle sensors and cameras (→ page 191).

360° camera

Function of the 360° camera

The 360° camera is a system comprising four cameras that cover the immediate vehicle surroundings. The cameras support you, for example, when parking or when exits are difficult to see.

The 360° camera includes the following cameras and evaluates their images:

- Rear view camera
- Front camera
- Two outside mirror cameras

The cameras serve solely as aids and may show a distorted view of obstacles, show them incorrectly or even omit them altogether. They are not a substitute for you having to pay attention to your surroundings. The responsibility for safe maneuvering and parking remains with you. Ensure that no persons, animals, objects, etc. are in the maneuvering area while maneuvering and parking.

The following camera perspectives are available on the central display:

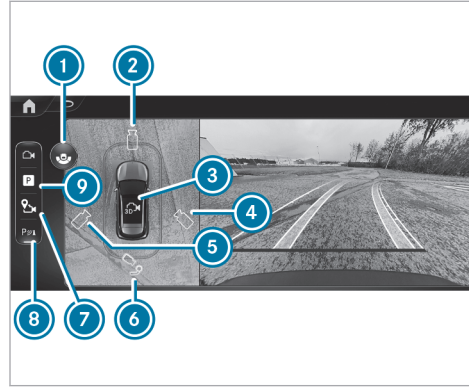

Overview of **Camera Views** menu (example)

- 1 Switching between standard view and wide-angle view
- 2 Image from the front camera
- 3 3D auto view
- 4 3D view right-hand side of the vehicle
- 5 3D view left-hand side of the vehicle
- 6 Trailer view (depending on the respective equipment) or rear view camera

- 7 Set the GPS activation point (→ page 251)
 - 8 Activating/deactivating Parking Assist PARKTRONIC (→ page 254)
 - 9 Menu **Parking Assistance**
- i** The warning display of Parking Assist PARKTRONIC is shown in all views (→ page 251).
- i** Availability of the 3D-Auto-View **3** and 3D-View **4**, **5** functions is dependent upon the respective equipment.

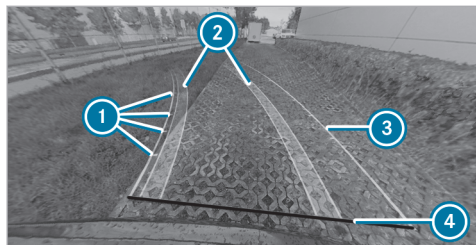

Function of the guide lines (example)

- ① Guide lines at a distance of approximately 1.6 ft (0.5 m), 3.3 ft (1.0 m), 5 ft (1.5 m) and 9.9 ft (3.0 m) from the rear area
 - ② Path indicating the route the wheels will take at the current steering angle (dynamic)
 - ③ Driven surface depending on the current steering angle (dynamic)
 - ④ Guide line at a distance of approximately 1.0 ft (0.3 m) from the rear area
- i When Active Parking Assist is active, paths and guide lines are displayed in green instead of yellow (→ page 255).

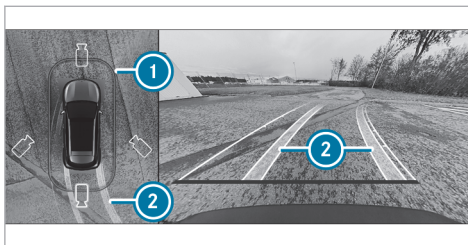

Image from the front camera or rear view camera (example)

- ① Warning display of Parking Assist PARKTRONIC (→ page 251)
- ② Path indicating the current steering angle

⚠ WARNING Risk of accidents due to objects not being displayed or being displayed in a distorted manner

Due to the projection of the cameras, objects in the 3D views may be strongly distorted or not displayed at all.

▶ Make sure that there are no persons, animals or objects etc., in the maneuvering area while maneuvering and parking.

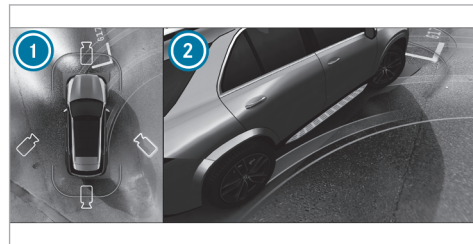

3D view left/right-hand side of the vehicle (example)

- ① Top view with warning display of Parking Assist PARKTRONIC
- ② Side view of the outside mirror cameras

In the 3D view, left/right-hand side of the vehicle, the virtual camera moves to the respective side of the vehicle ②. When you change the transmission position, the view is automatically adapted. In addition, the top view ① is displayed with the Parking Assist PARKTRONIC warning display.

- ❗ Display of the area beneath the vehicle may deviate from the actual circumstances.
- ❗ The area behind the vehicle is **not** displayed as a conventional mirror image in the 3D views.

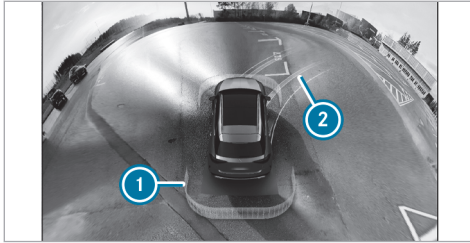

3D auto view (example)

- ❶ Warning display of Parking Assist PARKTRONIC (→ page 251)
- ❷ Guide lines

In the 3D auto view, the virtual camera moves to the standard view, facing forward from the rear above the roof. The view changes automatically when approaching obstacles.

If you touch the touchscreen, the view changes to a 3D view with free rotation. You can turn, tilt and zoom the views by touch.

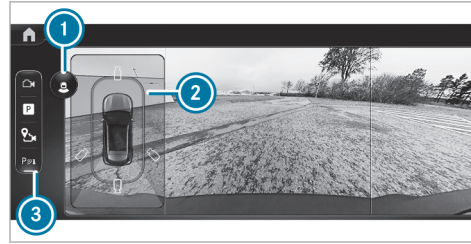

Wide-angle view (example)

- ❶ Switching between standard view and wide-angle view
- ❷ Display of Parking Assist PARKTRONIC (→ page 251)
- ❸ Activating/deactivating Parking Assist PARKTRONIC (→ page 254)

If you select the trailer view and no trailer is coupled to the vehicle, the following display appears:

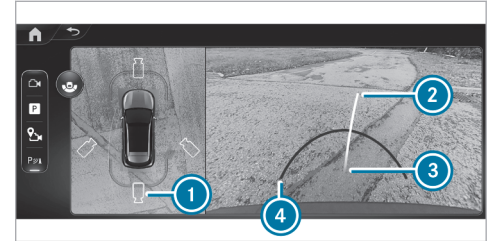

Trailer view (example)

- ❶ Switching between standard view and trailer view
 - ❷ Yellow guide line, locating aid
 - ❸ Ball head of the trailer hitch
 - ❹ Red guide line at a distance of approximately 1.0 ft (0.3 m) from the ball head of the trailer hitch
- ❗ In trailer mode, the guide lines are shown at the level of the trailer hitch.

When the electrical connection is established between the vehicle and the trailer, the display changes to the side camera view.

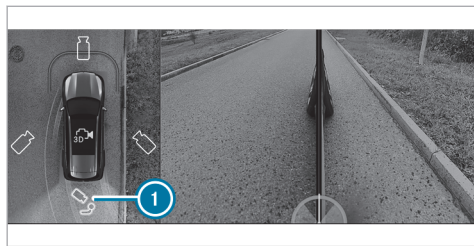

Side view of outside mirror camera in the trailer view (example)

- ① Switch to the side view of the outside mirror cameras

System limits

If the system is not ready for operation, the message **System Inoperative** appears on the driver display and/or on the central display.

If a camera perspective is selected and the central display is temporarily black or does not show a camera image, the camera system is also faulty or is not ready for operation.

⚠ WARNING Risk of accident due to restrictions in the function of the 360° camera

If the function of the 360° camera is restricted, there is a risk of collision with people or objects.

- ▶ Do not use the 360° camera in the event of function restrictions.
- ▶ Make sure that there are no persons, animals or objects etc., in the maneuvering area while maneuvering and parking.

The 360° camera will not function or will function only partially in the following situations, for example:

- You are driving forwards at a speed greater than approximately 10 mph (16 km/h).
- The doors are open.
- An outside mirror is not completely extended.
- The tailgate is open.
- The weather conditions are poor, e.g. heavy rain, snow, fog, storm or spray.

- The ambient light is poor, e.g. at night or if a light is shining into the camera.
- The camera lens is obstructed, dirty or fogged up. Refer to the notes on cleaning the 360° camera (→ page 343).
- If cameras or vehicle components in which the cameras are installed are damaged. In this event, have the cameras, their positions and their setting checked at a qualified specialist workshop.

For technical reasons, the standard height of the vehicle may be altered if the vehicle is carrying a heavy load and can result in inaccuracies in the guide lines and in the display of generated images.

The field of vision and other functions of the camera system may be restricted due to additional vehicle attachments (e.g. license plate bracket or bicycle rack).

- ① Contrast of the display may be impaired by abrupt direct sunlight or other light sources, e.g. when driving out of a garage. Particular attention must be afforded in this case.

- ❗ Have the display repaired or replaced if, for example, its use is considerably restricted due to pixel errors.

Observe also the information on vehicle sensors and cameras (→ page 191).

Off-road function of the 360° camera

The 360° camera can support you with different views when driving off-road.

The following views are available:

- Transparent hood
- Front view
- Rear view

To call up the function, select the Offroad menu in the multimedia system (→ page 295).

- ❗ Active Parking Assist and maneuvering assistant functions are unavailable in the drive program . Parking Assist PARKTRONIC is available in all drive programs when switched on. Please also note the system limits of the respective functions.

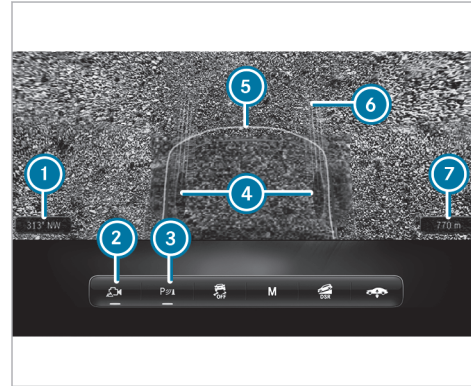

Transparent hood



Transparent hood display (example)

- 1 Cardinal point
- 2 Switch camera perspective on or off
- 3 Activating/deactivating Parking Assist PARKTRONIC (→ page 251)
- 4 Position of the wheels
- 5 Area under the hood
- 6 Path indicating the current steering angle
- 7 Altitude above sea level

- 6 Path indicating the current steering angle
- 7 Altitude above sea level

If the off-road menu is open in the central display and the button  is switched on, the transparent hood view is automatically displayed in the transmission position .

The transparent hood view shows a virtual image of the area directly in front of the bumper, in front of the wheels and under the hood. In addition, the current lane is displayed. The transparent hood can assist you when driving over difficult terrain, e.g. on rocky or uneven ground.

The front camera captured and recorded the hatched area under the hood . This area is then shown as soon as it has been traversed by the vehicle. If the vehicle has not been moved for some time, the recorded area is displayed in gray-scale and faded out.

NOTE Damage caused by obstacles that were not indicated

The transparent hood view is generated from images recorded previously by the 360° camera.

These recorded images may therefore possibly deviate from the actual conditions. In the meantime, moving objects that are not showing up in the current display may have found their way underneath the vehicle.

- ▶ Avoid any obstacles or navigate them with extreme caution.
- ▶ Adapt the travel speed to the respective conditions.

Front and rear view

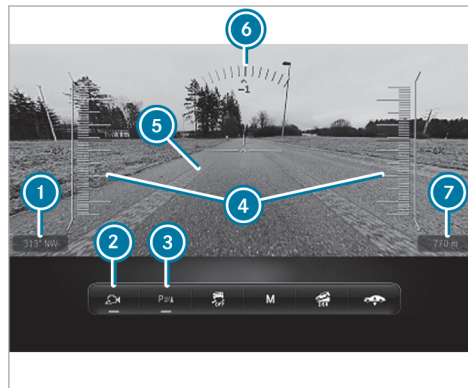

Front and rear view display (example)

- ① Cardinal point
- ② Switch camera perspective on or off
- ③ Activating/deactivating Parking Assist PARKTRONIC (→ page 251)
- ④ Uphill gradient indicator
- ⑤ Path indicating the current steering angle

- ⑥ Downhill gradient indicator
- ⑦ Altitude above sea level

i Note that the area between the vehicle and up to approx. 40 in (1 m) in front of the vehicle is not displayed.

The uphill and downhill gradient indicators are shown only in the front view.

If the vehicle is traveling faster than approx. 5 mph (8 km/h) the view automatically changes from transparent hood to front view. The camera image is closed if the vehicle is traveling faster than approx. 12 mph (20 km/h) - 19 mph (30 km/h) (depending on the drive program).

The rear-view camera image is automatically displayed when you engage reverse gear.

System limits

The area under the hood is not displayed correctly in the following situations:

- in the rain
- when driving in the dark
- when shadows fall on the area recorded by the camera

Observe the instructions on the 360° camera's function and its system limits. You may otherwise fail to recognize potential dangers (→ page 245).

■ Calling up the 360° camera views using the button

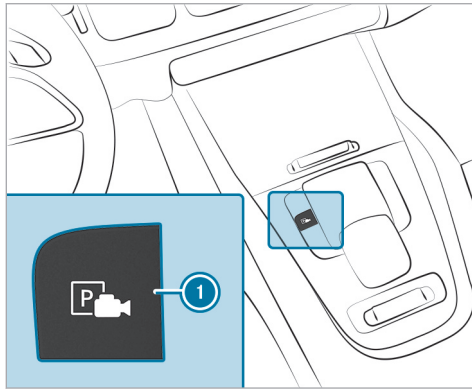

- ▶ Press button ①.
- ▶ Select **Camera Views** menu.

- ▶ Select the desired view in the multimedia system (→ page 245).

■ Selecting a view for the 360° camera (reverse gear)

- ▶ Engage reverse gear.
- ▶ Select the desired view in the multimedia system (→ page 245).

■ Managing 360° camera with GPS-activation positions

Multimedia system:

- ▶ ▶ Settings ▶ Assistance
- ▶ Camera

Renaming an activation position

- ① You can determine activation positions in the **Camera Views** menu (→ page 245).
- ▶ Select for the desired activation position.
- ▶ Select **Edit**.
- ▶ Enter a name and confirm. The activation position is stored under the new name.

Deleting an activation position

- ▶ Select for the desired activation position.
- ▶ Select **Delete Entry**.
- ▶ Confirm the prompt. The activation position is deleted.

■ Opening the camera cover

Multimedia system:

- ▶ ▶ Settings ▶ Assistance
- ▶ Camera

- ▶ Select **Open Camera Cover**.

- ① The camera cover closes automatically after some time, or after the vehicle is switched on or off.

Parking Assist PARKTRONIC

■ Function of Parking Assist PARKTRONIC

Parking Assist PARKTRONIC is an electronic parking assistance system that monitors the area surrounding your vehicle. The distance between your

vehicle and a detected obstacle is displayed visually and acoustically.

The passive side impact protection also warns you of obstacles to the side. These must be detected beforehand by the sensors in the front or rear bumper while you are driving past them. If you steer in the direction of a detected obstacle and there is a risk of a lateral collision, a warning is issued.

Passive side impact protection can be activated and deactivated via the multimedia system (→ page 255).

In order that front or rear obstacles to the side can be displayed, the vehicle must first travel a distance of at least half a vehicle length. Once the vehicle has traveled a distance of one vehicle length, obstacles on all sides can be shown.

Parking Assist PARKTRONIC serves solely as an aid. It is not a substitute for you having to pay attention to your surroundings. The responsibility for safe maneuvering, parking and exiting parking spaces remains with you. Ensure that no persons, animals, objects, etc. are in the maneuvering area

while maneuvering and parking in/exiting parking spaces.

Displays on the central display

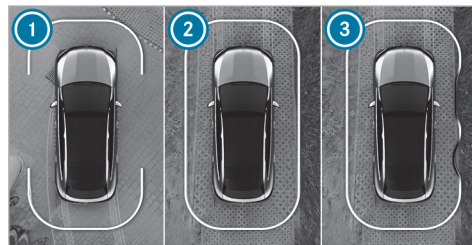

Example: vehicles with 360° camera

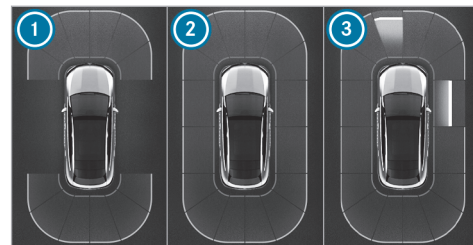

Example: vehicles with rear-view camera

- ① Ready for display at the front and rear
- ② Ready for display all around
- ③ Ready for display all around and obstacles detected

As soon as Parking Assist PARKTRONIC is ready for display, the respective areas ① to ③ of the display are shown in blue.

The color of the display changes depending on the distance to the detected obstacle:

- **Blue:** > 3.3 ft (1 m) (no obstacles detected)
- **Yellow:** approximately 3.3 ft (1 m) – 2.3 ft (0.7 m)

- **Orange:** approximately 2.3 ft (0.7 m) - 1.3 ft (0.4 m)
- **Red:** < 1.3 ft (0.4 m)

Vehicles with 360° camera: the boundary line shifts dynamically depending on the position and distance of the obstacles detected.

An intermittent warning tone also sounds depending on the distance to the obstacle detected. You can set the timing of the warnings in the multimedia system. In the **Warn Early** setting, the system warns you from a distance of 3.3 ft (1 m). In the standard setting, from a shorter distance of 1.3 ft (0.4 m).



Example: vehicles with 360° camera

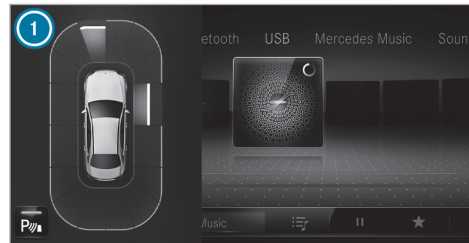

Example: vehicles with rear-view camera

If you are not in the **Camera & Parking** menu and an obstacle in the vehicle's path is detected, a pop-up window ❶ appears on the central display if the following requirements are met:

- **Vehicles without Active Parking Assist:** when you are driving no faster than 8 mph (12 km/h).
- **Vehicles with Active Parking Assist:** when you are driving no faster than 11 mph (18 km/h).

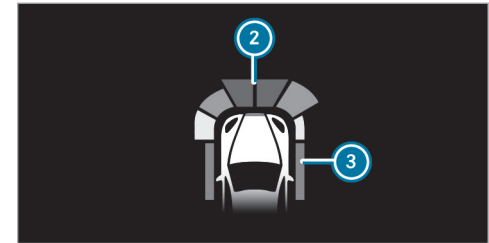

Head-up display (example)

Optionally, obstacles detected by Parking Assist PARKTRONIC from a distance of approximately 3.3 ft (1.0 m) in front ❷ and 2.3 ft (0.7 m) at the

sides ③ can also be displayed on the head-up display.

System limits

Parking Assist PARKTRONIC does not necessarily take into account the following obstacles:

- Obstacles below the detection range, e.g. persons, animals or objects
- Obstacles above the detection range, e.g. protruding loads, overhangs or loading ramps of trucks
- Pedestrians or animals approaching the vehicle from the side
- Objects placed next to the vehicle

Obstacles on the sides are not shown in the following situations, for example:

- You park the vehicle and switch it off.
- You open the doors.

After the vehicle is restarted, obstacles must be detected again by driving past them before a new warning can be issued.

Observe also the system limits of the following systems:

- Rear-view camera (→ page 242)
- 360° camera (→ page 245)

Observe the information on vehicle sensors and cameras; otherwise the system cannot function properly (→ page 191).

Vehicles with trailer hitch: If a transport device, e.g. trailer or bicycle rack is attached to the trailer hitch and the electrical connection is correctly established, Parking Assist PARKTRONIC is deactivated for the rear zone.

Problems with Parking Assist PARKTRONIC

If the Parking Assist PARKTRONIC display lights up red for approximately three seconds and then goes out, and the  symbol appears on the driver display, the system may have been deactivated due to signal interference. Start the vehicle again and check whether Parking Assist PARKTRONIC works in a different location.

If a warning tone also sounds, the causes may be as follows:

- **The sensors are dirty:** clean the sensors (→ page 343).
- **Parking Assist PARKTRONIC has been deactivated due to a malfunction:** restart the vehicle. If the problem persists, consult a qualified specialist workshop.

■ Activating/deactivating Parking Assist PARKTRONIC

 **NOTE** Vehicle damage during parking or maneuvering due to objects at close range

Parking Assist PARKTRONIC may not detect certain objects close to the vehicle.

 When parking or maneuvering, look out in particular for objects that are underneath or above the sensors, e.g. flower pots or drawbars. Otherwise, the vehicle or other objects could be damaged.

Requirements

- The camera menu is open.
 - Or: the Parking Assist PARKTRONIC pop-up window is displayed.
- ▶ Tap  on the central display.

If the indicator lamp is lit, Parking Assist PARKTRONIC is active. If the indicator lamp does not light up or the  symbol is displayed, Parking Assist PARKTRONIC is not active.

 Parking Assist PARKTRONIC will be activated automatically when the vehicle is started.

Alternatively, Parking Assist PARKTRONIC can be activated or deactivated on the quick-access menu.

▶ **Setting the warning tones of Parking Assist PARKTRONIC**

Multimedia system:

 ▶▶ Settings ▶▶ Assistance
▶▶ Parking ▶▶ PARKTRONIC

Setting warning tones

- ▶ Select **Set Warning Tones**.

- ▶ Set the desired level under **Volume** or **Tone Pitch**.

Activating/deactivating audio fadeout

- ▶ Select **Audio Fadeout** and activate or deactivate **Audio Fade for Warnings**.
The volume of the media source currently playing is reduced when a warning tone sounds in Parking Assist PARKTRONIC.

or

- ▶ Select **Audio Fadeout** and switch **Audio Fadeout When in R** on or off.
The volume of the media source currently playing is reduced when reverse gear is engaged.

Setting warning timing

- ▶ Select **Time of Warning**.
▶ Set the desired warning time for **Front** or **Rear**.
▶ Activate or deactivate **Side Warning**.

Active Parking Assist

■ **Function of Active Parking Assist**

Active Parking Assist is an electronic parking assistance system that uses ultrasound with the assistance of the rear-view camera or 360° camera. When you are driving forwards up to approximately 22 mph (35 km/h), the system automatically measures parking spaces on both sides of the vehicle.

Active Parking Assist serves solely as an aid. It is not a substitute for you having to pay attention to your surroundings. The responsibility for safe maneuvering, parking and exiting parking spaces remains with you. Ensure that no persons, animals, objects, etc. are in the vehicle's path.

Active Parking Assist offers the following functions:

Vehicles with rear-view camera



- Parking in parking spaces parallel to the roadway
- Backing up into parking spaces perpendicular to the roadway

The parking space is freely selectable. The parking procedure is executed with the vehicle backing up.

Vehicles with 360° camera

- Parking in parking spaces parallel to the roadway
- Parking in parking spaces perpendicular to the roadway (either forwards or backing up as desired)
- Parking in parking spaces that can be detected as such only from markings (forexample at the roadside)
- Exiting parking spaces if you have parked using Active Parking Assist



The parking space is freely selectable. The parking direction (forwards or backing up) can also be freely selected, depending on the orientation of the parking space.

If Active Parking Assist is available, the notification  appears on the driver display. When the system detects parking spaces, the notification  appears. The arrows show the side of the

roadway on which free parking spaces are located. These are then shown on the central display. When Active Parking Assist is activated, the turn signal indicators are activated based on the calculated path of your vehicle. The parking and unparking procedures are assisted by acceleration, braking, steering and gear changes.

To start the parking procedure, press the button  (→ page 257).

Active Parking Assist will be canceled in the following situations:

- You press the button  again.
- You begin steering.
- You select the park position .
- You engage the electric parking brake.
- ESP® intervenes.
- You open the driver's door.

System limits

If the exterior lighting is malfunctioning, Active Parking Assist is not available.

Objects above or below the detection range of Active Parking Assist, e.g. protruding loads, overhangs or loading ramps of trucks or parking space boundaries are not detected when measuring the parking space. These are also not subsequently taken into account when calculating the parking procedure. In some circumstances, Active Parking Assist may therefore prematurely guide you into the parking space or brake too late.

Certain environmental conditions, such as snowfall or heavy rain, may lead to a parking space being mismeasured. Parking spaces that are partially occupied by trailer drawbars might not be identified as such or may be measured incorrectly. Use Active Parking Assist only on level road surfaces with adequate grip.

⚠ WARNING Risk of accident due to objects located above or below the detection range of Active Parking Assist

If there are objects above or below the detection range, the following situations may arise:

- Active Parking Assist may steer too early.

- The vehicle may not stop in front of these objects.

There is a danger of collision!

- ▶ In these situations, do not use Active Parking Assist.

Active Parking Assist can also display unsuitable parking spaces, e.g. parking spaces in which parking is not permitted or on unsuitable surfaces.

Do not use Active Parking Assist in the following situations, for example:

- In extreme weather conditions, such as ice, packed snow or in heavy rain.
- When transporting a load that protrudes beyond the vehicle.
- If the parking space is on a steep downhill or uphill gradient.
- When snow chains are installed.
- When a trailer or bicycle rack is attached.
- Directly after a tire change or when spare tires are installed.

- If the tire pressure is too low or too high.
- On steep downhill gradients of more than approximately 15 %.
- If the vehicle level has been offset, e.g. mounting the curb on one side (vehicles with level control).

■ Parking with Active Parking Assist

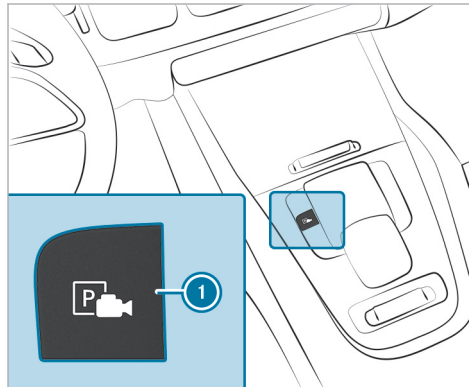

- ▶ Press button ①.



Parking Assist menu (example for left-hand side of the screen)

- ▶ Select the **Parking Assistance** menu ②.

Parking spaces ③ detected by the system will be shown on the central display.

At speeds greater than approximately 10 mph (16 km/h), the camera perspective on the right-hand side of the screen will switch off.

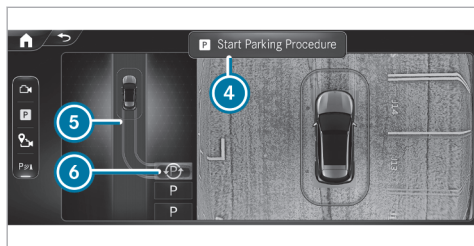

Parking Assist menu (example)

When the vehicle is at a standstill, indicated vehicle path ⑤ into currently selected parking space ⑥ will also appear.

- ▶ If a parking space is displayed: stop the vehicle.
- ▶ If necessary, select another parking space.
- ▶ **Vehicles with 360° camera:** to change the parking direction, tap the selected parking space again.
- ▶ **To start the parking procedure:** press button ① again.

or

- ▶ Depress the brake pedal and select **Start Parking Procedure** ④ (depending on the respective vehicle equipment).
- ▶ Take your hands off the steering wheel. The vehicle will drive into the selected parking space.

The duration of the parking procedure will be indicated by a progress bar.

The turn signal indicator will be switched on automatically when the parking procedure begins. You are responsible for engaging the turn signal indicator in accordance with the traffic conditions. If necessary, engage the turn signal indicator accordingly.

⚠ WARNING Risk of accident due to vehicle swinging out while parking or pulling out of a parking space

While parking or exiting a parking space, the vehicle swings out and can drive onto areas of the oncoming lane.

This could cause you to collide with objects or other road users.

- ▶ Pay attention to objects and other road users.
- ▶ Where necessary, stop the vehicle or cancel the parking procedure with Active Parking Assist.

Once the parking procedure is complete, a message reading **Active Parking Assist Finished** will appear.

- ▶ Secure the vehicle against rolling away. When necessitated by legal requirements or local conditions: turn the wheels towards the curb.
- ① You can stop the vehicle and change the transmission position during the parking procedure. The system will then calculate a new vehicle path. If no new vehicle path is available, the transmission position may be changed again, or the process may be canceled.

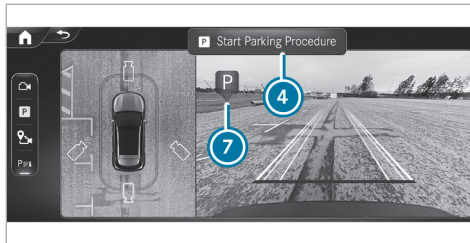

Immediate parking via the **Camera Views** menu

- ▶ Select the **Camera Views** menu.
- ▶ When the vehicle is stationary and in transmission position **R** and symbol **7** appears on the camera image: press button **1** again.

or

- ▶ Depress the brake pedal and select **Start Parking Procedure** **4** (depending on the respective vehicle equipment). The parking procedure will be initiated for the detected parking space.

- i** The parking space and parking direction cannot be changed in the case of immediate parking.

Exiting a parking space with Active Parking Assist

Requirements:

- The vehicle is equipped with a 360° camera.
- The vehicle has been parked with Active Parking Assist.

- ▶ Start the vehicle.

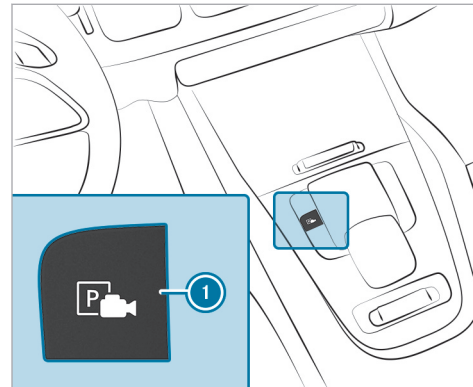

- ▶ Press button **1**.



Parking Assist menu (example for left-hand side of the screen)

- ▶ Select the **Parking Assistance** menu **2**.
- ▶ If necessary, change the direction of exit **4**.
- ▶ **To initiate the unparking procedure:** press button **1** again.

or

- ▶ Depress the brake pedal and select **Start Unparking Procedure** **3** (depending on the respective vehicle equipment).

- ▶ If necessary, change the transmission position. Observe any messages shown on the driver display and central display. The vehicle will move out of the parking space. The duration of the unparking procedure will be indicated by a progress bar.

The turn signal indicator will automatically be switched on when the unparking procedure is initiated, and automatically switched off again when it is completed. You are responsible for selecting the turn signal indicator in accordance with the traffic conditions. If necessary, select the turn signal indicator accordingly.

After the parking space has been exited, a warning tone and the  **Active Parking Assist Finished: Take Control of Vehicle** message will prompt you to take control of the vehicle. You will have to accelerate, brake, steer and change gear yourself again.

If you do not react to the prompt to take control of the vehicle, the system will apply the brakes to bring the vehicle to a standstill.

■ Pausing Active Parking Assist

You can interrupt the parking or unparking procedure of Active Parking Assist by performing one of the following actions, for example:

- ▶ Depress the brake pedal.
- ▶ Open the front passenger door, a rear door, the tailgate or the hood.
- ▶ Apply the electric parking brake or activate the HOLD function.
- ▶ **To resume the parking or unparking procedure:** gently depress the accelerator pedal.

- ⓘ If the electric parking brake was applied before Active Parking Assist was activated, depress the accelerator pedal gently to start the parking or unparking procedure.

Check the area around your vehicle again before resuming a paused parking procedure. Ensure that persons, animals or objects are no longer in the maneuvering range. Observe also the system limits of Active Parking Assist.

■ Automatic braking function of Active Parking Assist

Persons or objects detected in the vehicle's path may trigger a sudden braking action, which will in turn halt the parking or unparking procedure. The vehicle will then remain at a standstill. The parking or unparking procedure is resumed if you depress the accelerator pedal.

Check the area around your vehicle again before resuming the parking or unparking procedure. Ensure once again that no persons, animals or objects are in the vehicle's path. Observe also the system limits of Active Parking Assist.

Maneuvering assistance

■ Function of Drive Away Assist

Drive Away Assist can reduce the severity of an impact when you are pulling away. If the system detects an obstacle in the direction of travel, the vehicle's speed will briefly be restricted to approximately 1 mph (2 km/h). When a critical situation is detected, the  symbol will appear on the central display.

Drive Away Assist can be switched on or off on the **Maneuvering Assistance** menu.

- ❗ You can cancel intervention by Drive Away Assist at any time by deactivating Parking Assist PARKTRONIC.

⚠ WARNING Risk of accident caused by limited detection performance of Drive Away Assist

Drive Away Assist cannot always clearly identify objects and traffic situations.

- ▶ Always pay careful attention to the traffic situation; do not rely on Drive Away Assist alone.
- ▶ Be prepared to brake or swerve as necessary, provided the traffic situation permits and that it is safe to take evasive action.

Drive Away Assist serves solely as an aid. It is not a substitute for you having to pay attention to your surroundings. The responsibility for safe maneuvering, parking and exiting parking spaces

remains with you. Ensure that no persons, animals or objects etc. are in the vehicle's path.

A risk of collision may arise in the following situations, for example:

- If the driver mixes up the accelerator and brake pedals.
- If an incorrect transmission position is engaged.

The Drive Away Assist function will be active in the following circumstances:

- If Parking Assist PARKTRONIC is activated.
- If you shift the transmission position to **R** or **D** when the vehicle is at a standstill.
- If the detected obstacle is less than approximately 3.3 ft (1.0 m) away.
- Maneuvering assistant is activated (→ page 263).

System limits

Drive Away Assist is not available in the  drive program.

The performance of Drive Away Assist will be limited on uphill gradients.

If a transport device, e.g. trailer or bicycle rack, is attached to the trailer hitch and the electrical connection is correctly established, Drive Away Assist will not be available.

- ❗ Also observe the system limits of Parking Assist PARKTRONIC (→ page 251).

Function of Cross Traffic Alert

- ❗ The Cross Traffic Alert function is available only for vehicles with Blind Spot Assist or Active Blind Spot Assist.

The Cross Traffic Alert function can warn drivers of any crossing traffic when they are backing up and maneuvering out of a parking space. The radar sensors in the bumper also monitor the area adjacent to the vehicle. If a critical situation is detected, the symbol  appears on the central display, and the vehicle can be braked automatically.

If the radar sensors are obstructed by vehicles or other objects, detection is not possible.

The Cross Traffic Alert function is active under the following conditions:

- If the vehicle is backing up at walking pace.
 - Maneuvering assistant is activated (→ page 263).
- ① Observe also the instructions on Blind Spot Assist and Active Blind Spot Assist (→ page 227).

System limits

The Cross Traffic Alert function is not available in the drive program .

The Cross Traffic Alert function is not available on uphill gradients.

If a transport device, e.g. trailer or bicycle rack is attached to the trailer hitch, and the electrical connection is correctly established, the Cross Traffic Alert function is not available.

Function of close-range braking

Close-range braking can prevent collisions with pedestrians when the vehicle is backing up at slow speeds. If the rear-view camera detects a

person in the vehicle's path, the vehicle can be braked to a standstill.

Close-range braking can intervene under the following conditions:

- The vehicle is backing up at a speed slower than 6 mph (10 km/h).
- The camera image is shown on the central display (→ page 251).

Depending on the respective country, close-range braking can be deactivated or activated in the **Maneuvering Assistance** menu (→ page 263).

When close-range braking is triggered, the symbol  appears in red in the selected view in the **Camera & Parking** menu.

① If close-range braking is not available, the symbol  appears in gray.

Close-range braking serves solely as an aid. It is not a substitute for you having to pay attention to your surroundings. The responsibility for safe maneuvering, parking and exiting parking spaces remains with you. Ensure that no persons, animals, objects, etc. are in the vehicle's path.

⚠ WARNING Risk of accident caused by limited detection by the maneuvering brake function

The maneuvering brake function cannot always clearly detect people. Other obstacles are not detected by the function.

In these cases, the function may brake unnecessarily or not brake at all.

- ▶ Always pay careful attention to the traffic situation; do not rely on the maneuvering brake function alone.
- ▶ Be ready to brake.

System limits

Close-range braking is not available in the drive program .

Observe the system limits of the following functions:

- Active Parking Assist (→ page 255)
- 360° camera (→ page 245)
- Rear-view camera (→ page 242)

The close-range braking function is not available in the following situations:

- on uphill gradients
- If transport equipment, e.g. a trailer or bicycle rack, is attached to the trailer hitch and the electrical connection has been correctly established.

■ Activating/deactivating the maneuvering assistant

Multimedia system:

→  » Settings » Assistance
» Parking

- ① This function is an on-demand feature (→ page 25).
- ① The Activating/deactivating maneuvering assistant function is not available in all countries.
- ▶ Select **Maneuvering Assistance**.
- ▶ Activate or deactivate the desired maneuvering assistant.

Trailer Maneuvering Assist

■ Function of Trailer Maneuvering Assist

- ① This function is an on-demand feature (→ page 25).

⚠ WARNING Risk of accident due to unsuitable trailers

Trailers with a steered axle or a fifth wheel cannot be used with Trailer Maneuvering Assist.

Due to this, the trailer cannot be maneuvered in the desired direction and you can cause a collision or the trailer can rollover.

- ▶ Only use Trailer Maneuvering Assist with trailers with fixed drawbars and axles.

⚠ WARNING Risk of accidents due to unsuitable hitching devices

Trailer hitches without a ball head, such as a Hensley hitch or a pintle hitch, as well as any hitch adapters or multiple hitch ball mounts,

cannot be guided by Trailer Maneuvering Assist.

This will prevent the trailer from maneuvering in the desired direction and you may cause a collision or the trailer may roll over.

- ▶ Use Trailer Maneuvering Assist only with a trailer hitch with a ball head.
- ▶ Use Trailer Maneuvering Assist only with a trailer hitch without additional attachments, such as a weight distribution system or sway control.
- ▶ Use Trailer Maneuvering Assist only with a trailer with a drawbar that has no additional attachments or superstructures.
- ▶ Use Trailer Maneuvering Assist only with a hitch ball mount. The use of an additional hitch adapter or hitch ball mount is not permitted.

⚠ WARNING Danger of accident due to incorrect taught values for the ball head position

If after changing the trailer, ball neck or changing the ball head position the values for the ball head position are **not** reset and a calibration drive is carried out again, Trailer Maneuvering Assist will not function properly. This will prevent the trailer from maneuvering in the desired direction and you may cause a collision.

- ▶ After changing the trailer, the ball neck or the ball head position, do not use Trailer Maneuvering Assist without carrying out a calibration drive again.
- ▶ After changing the trailer, the ball neck or the ball head position, reset the taught-in values.
- ▶ Then, carry out a calibration drive to teach in the values of the new ball head position.

Information on resetting the taught-in values for the ball head position and for calibration drive (→ page 270).

! NOTE Damage due to overhanging loads in front or drawbar installations

The vehicle and the trailer may be damaged during maneuvering due to overhanging loads at the front of the trailer or drawbar installations.

- ▶ Pay attention to overhanging loads or drawbar installations while maneuvering.

Trailer Maneuvering Assist assists you when backing up with a trailer. The rear-view camera monitors the articulation angle between the vehicle and the trailer and adjusts it to a specified value. Trailer Maneuvering Assist also limits your speed.

For Trailer Maneuvering Assist to function correctly, a calibration drive must be carried out for the respective trailer and ball neck as well as following a change in ball head position. The current ball head position is taught-in during the calibration drive (→ page 270).

Trailer Maneuvering Assist serves solely as an aid. It is not a substitute for you having to pay attention to your surroundings. The responsibility for safe maneuvering, parking and exiting parking spaces remains with you. Ensure that no persons, animals, objects, etc. are located in the maneuvering area while maneuvering and parking in/exiting parking spaces.

You can enter the articulation angle value directly via the multimedia system, or use a straightening or 90° maneuver. When carrying out a straightening maneuver, the system calculates the articulation angle automatically and straightens the vehicle/trailer combination to the trailer's current direction.

Observe the notes regarding trailer operation (→ page 266).

System limits

Observe the system limits of the following functions:

- Active Parking Assist (→ page 255)
- 360° camera (→ page 245)
- Rear-view camera (→ page 242)

The system may be impaired or inoperative in the following situations:

- The uphill gradient is greater than approximately 15 %.
- The height of the ball head above even ground is less than 13.8 in (0.35 m) or greater than 21.6 in (0.55 m).

■ Using Trailer Maneuvering Assist

Requirements:

- The vehicle has been started and is stationary.
- A trailer is selected in the **Vehicle** menu (→ page 270).
- A trailer has been detected.
- A calibration drive was carried out using the trailer, ball neck and current ball head position (→ page 270).
- A straight travel maneuver was carried out to calibrate Trailer Maneuvering Assist, observing the instructions on the central display (→ page 270).
- The uphill gradient is less than approximately 15 %.

- The tailgate is closed.
 - The electric parking brake is not applied.
 - The driver's seat belt is fastened.
- ① To ensure that Trailer Maneuvering Assist functions correctly, reset the taught-in values for the ball head position after each change of trailer and ball neck as well as when changing the ball head position. Then perform a calibration drive again. Information on resetting and calibration drive (→ page 270).

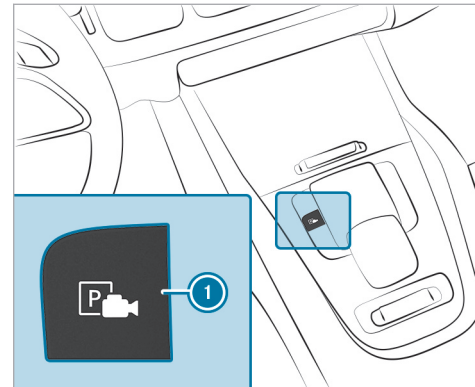

- ▶ Engage reverse gear **R**.
- ▶ Press the button **1**. The camera image is shown on the central display.
- ▶ Take your hands off the steering wheel.

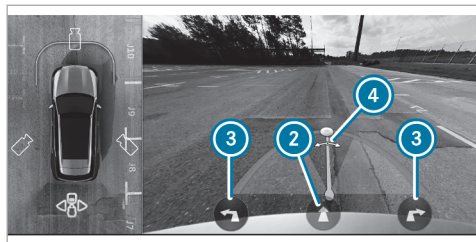

i This image is shown as an example and is without trailer.

You can select various maneuvers in the Trailer Maneuvering Assist menu. The maneuvers available depend on the trailer's current articulation angle and length.

▶ To adjust the articulation angle: select **4**. To change the articulation angle, swipe to the left or right on the central display in the entire area of the camera image.

or

▶ To activate the straightening maneuver: select **2**.

The system calculates the articulation angle in such a way that the direction of the trailer at the time of activation is maintained. There is a short countersteering movement of the trailer while the vehicle is backing up, which then guides it back to the desired line. This allows the vehicle to align with the trailer, while at the same time maintaining the trailer's direction.

or

▶ To activate the 90° maneuver:

- Align the vehicle in the same direction (line) as the trailer.
- Select **3** (left or right).

The system calculates the articulation angle so that a trailer can be maneuvered into a driveway at the most acute angle possible when it is perpendicular to its own vehicle. After the maneuver, the vehicle is aligned again in the trailer's direction.

▶ Accelerate and brake as required.

i The maximum articulation angle depends on the length of the trailer. The system calculates

this by driving the vehicle forwards, including cornering. Before the trailer length has been calculated, the maximum articulation angle is approximately 23°. The longer the trailer, the greater the maximum articulation angle (max. approximately 60°).

i Be aware of all surroundings and always remain ready to brake.

Trailer hitch

Notes on trailer operation

! **NOTE** Mercedes-AMG vehicles

▶ Observe the notes in the Supplement. You could otherwise fail to recognize dangers.

! **WARNING** Risk of accident due to unsuitable ball neck

If you install an unsuitable ball neck, the trailer hitch and the rear axle may be overloaded.

This can significantly impair the driving characteristics and the trailer may become loose. There is a risk of fatal injury.

- ▶ Only install a ball neck that complies with the permissible dimensions and is designed for the requirements of trailer operation.
- ▶ Do not modify the ball neck or the trailer hitch.

The values approved by the manufacturer can be found on the identification plates and in the "Technical data" section under "Trailer hitch" for the towing vehicle (→ page 417).

⚠ WARNING Risk of accident due to vehicle/trailer combination swerving

If you drive too fast in trailer operation, the vehicle/trailer combination may start to swerve.

This could cause you to lose control of the vehicle/trailer combination. The vehicle/trailer combination may even rollover.

- ▶ Under no circumstances should you try to straighten the vehicle/trailer combination by increasing your speed.
- ▶ Reduce the speed and do not counter-steer.
- ▶ Brake if necessary.

! NOTE Damage to the engine resulting from overheating

- ▶ If you subsequently have a trailer coupling retrofitted, depending on the vehicle type, changes to the engine cooling system may be required.

In the case of retrofitting a trailer coupling, please observe the attachment points on the vehicle frame.

Retrofitting a trailer hitch is permissible only if a trailer load is specified in your vehicle documents. If this is not the case, the vehicle is not approved for trailer operation.

Further information can be obtained at a qualified specialist workshop.

If the trailer coupling is detachable, it is essential to comply with the operating instructions of the trailer coupling manufacturer.

Couple and uncouple the trailer carefully. If you do not couple the trailer to the towing vehicle correctly, the trailer may become detached.

Observe the following notes on the tongue weight:

- do not use a tongue weight that exceeds or falls below the permissible tongue weight
- use a tongue weight as close as possible to the maximum tongue weight

Do not exceed the following values:

- Permissible trailer load
- Permissible rear axle load of the towing vehicle
- Permissible gross mass of the towing vehicle
- Permissible gross mass of the trailer
- Maximum permissible speed of the trailer

Ensure the following before starting a journey:

- the tire pressure on the rear axle of the towing vehicle is set for a maximum load

- the lighting of the connected trailer is operational

In the event of increased rear axle load, the car/trailer combination may not exceed a maximum speed of 62 mph (100 km/h) for reasons concerning the operating permit. This also applies in countries in which the permissible maximum speed for car/trailer combinations is above 62 mph (100 km/h).

Vehicles with AIRMATIC or E-ACTIVE BODY CONTROL: if the socket of the trailer hitch is occupied (e.g. by a trailer or rear bicycle rack), the vehicle will be set to the normal level at speeds greater than 19 mph (30 km/h). This is done regardless of which drive program has been selected.

Attaching the ball neck

⚠ WARNING Risk of accident and injury due to incorrectly installed ball neck

If the ball neck is not properly mounted and secured, it may come loose along with the trailer while the vehicle is in motion and

endanger other road users. There is a risk of fatal injuries.

- ▶ Mount and secure the ball neck as described in the installation instructions of the ball neck manufacturer.
- ▶ With the ball neck mounted, always make sure it is properly secured before commencing a journey.

Attaching the ball neck

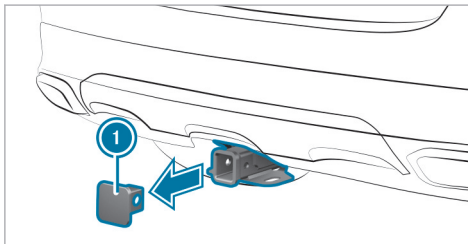

- ▶ Secure the vehicle against rolling away.
- ▶ Remove cover cap ① from the ball neck mount in the direction of the arrow.

- ▶ Store cover cap ① such that it cannot move around.
- ▶ Comply with the installation instructions of the ball neck manufacturer.

Observe the notes on loading the vehicle.

- ① For Trailer Maneuvering Assist to function properly, the taught-in values for the ball head position must be reset after each change of trailer and ball neck, and when the ball head position is changed. A calibration drive must then be performed again. Information on resetting and calibration drive (→ page 270).

Coupling up/uncoupling a trailer

⚠ WARNING Risk of injury due to a change in vehicle level

Vehicles with level control system: the vehicle level may be changed unintentionally, e.g. by other persons. If you couple or uncouple the trailer during this time, you may become trapped. In addition, other people could become

trapped if their limbs are between the vehicle body and the tires or underneath the vehicle.

Observe the following when coupling or uncoupling:

- ▶ Do not open or close any doors or the tailgate.
- ▶ Do not initiate the level control system and do not operate DYNAMIC SELECT.
- ▶ Do not lock or unlock the vehicle.

The trailer will be correctly detected by the vehicle only if the following conditions are met:

- the trailer is connected correctly
- the trailer lighting system is in working order

i Before Trailer Maneuvering Assist is used and each time the trailer is changed, a calibration drive must be performed with the ball neck used (→ page 270).

A correctly connected trailer influences, among other things, the functions of the following systems:

- ESP® trailer stabilization

- Trailer Maneuvering Assist
- Active Lane Keeping Assist
- Parking Assist PARKTRONIC
- Active Parking Assist
- Blind Spot Assist
- Active Blind Spot Assist
- Drive Away Assist
- Cross Traffic Alert
- Close-range braking
- Rear view camera
- 360° camera
- AIRMATIC
- E-ACTIVE BODY CONTROL

Vehicles without level control system: the ball head height will change depending on the vehicle's load. In this case, use a trailer with a height-adjustable drawbar.

Coupling up a trailer

! **NOTE** Damage to the starter battery due to full discharge

Charging the trailer battery using the power supply of the trailer can damage the starter battery.

- ▶ Do not use the vehicle's power supply to charge the trailer battery.

Information about a suitable ball neck for Mercedes-Benz vehicles can be obtained from a qualified specialist workshop, e.g. an authorized Mercedes-Benz Center.

- ▶ Secure the vehicle against rolling away.
- ▶ Remove the cover cap from the ball neck mount and store it in a safe place (→ page 268).
- ▶ Position the trailer on a level surface behind the vehicle and couple it up to the vehicle.
- ▶ Establish the electrical connection between the vehicle and the trailer.

- ⓘ Accessories can be connected to the permanent power supply up to 180 W and to the power supply that is switched on via the ignition lock.

Uncoupling a trailer

⚠ WARNING Risk of being crushed and becoming trapped when uncoupling a trailer

When uncoupling a trailer with an engaged inertia-activated brake, your hand may become trapped between the vehicle and the trailer drawbar.

- ▶ Do not uncouple trailers with an engaged overrun brake.

! NOTE Damage during uncoupling with an engaged overrun brake

The vehicle may be damaged if you uncouple with an engaged overrun brake.

- ▶ Do not uncouple trailers with an engaged overrun brake.

⚠ WARNING Risk of becoming trapped when disconnecting the trailer cable

Vehicles with level control system: the vehicle may lower when you disconnect the trailer cable.

This could result in other people becoming trapped if their limbs are between the vehicle body and the tires or underneath the vehicle.

- ▶ Make sure nobody is underneath the vehicle or in the immediate vicinity of the wheel arches when you disconnect the trailer cable.
- ▶ Secure the vehicle against rolling away.
- ▶ Disconnect the electrical connection between the vehicle and the trailer.
- ▶ Uncouple the trailer.
- ▶ Remove the ball neck, following the ball neck manufacturer's installation instructions.
- ▶ Place the cover cap on the ball neck mount.

Selecting a trailer type

Multimedia system:

→ →  → Settings → Vehicle → Driving → Trailer Type

Configuring settings for a trailer

The settings on this menu make it possible to calculate a route suitable for the selected trailer and optimize the calculated arrival time.

- ▶ Select the desired trailer type.
- ▶ Select the maximum permissible speed for the selected trailer.
- ▶ **To save changes:** select **Confirm**.

- ⓘ When contact with the trailer socket is established (trailer/rear bicycle rack), a menu will automatically appear on the display.

The following options are available:

- Bicycle rack
- Small trailer
- Large trailer

Calibrating a trailer coupling

- ▶ Select **Trailer coupling has been changed** to start calibration for the new ball head position.
- ▶ **To save changes:** select **Confirm**.
- ▶ Activate Trailer Maneuvering Assist and follow the corresponding instructions on the central display.
When the **Activated: Trailer Maneuvering Assist** message is displayed, calibration is complete and Trailer Maneuvering Assist can be used.

Vehicle towing instructions

The vehicle is not suitable for the use of tow bar systems that are used for flat towing or dinghy towing, for example. Attaching and using tow bar systems may result in damage to the vehicle. When you are towing a vehicle with tow bar systems, safe driving characteristics cannot be guaranteed for the towing vehicle or the towed vehicle. The vehicle-trailer combination may swerve from side to side.

! NOTE Mercedes-AMG Hybrid

- ▶ Observe the notes in the Supplement. You could otherwise fail to recognize dangers.

The Mercedes-AMG Hybrid model is not available in all countries.

Observe the following information:

- Permitted towing methods (→ page 361)
- The notes on towing the vehicle with both axles on the ground (→ page 362)

Notes on the driver display

⚠ WARNING Risk of accident if the driver display malfunctions

if the driver display is inoperative or its functions are restricted, you will not receive information about such issues as other function restrictions, speed, current drive range and the status of the electric parking brake.

This will impair operating safety.

- ▶ Stop the vehicle immediately in accordance with the traffic conditions and switch it off. Do not continue driving.
- ▶ Consult a qualified specialist workshop.
- ▶ Have the vehicle transported rather than towed.

! NOTE Mercedes-AMG vehicles

- ▶ Observe the notes in the Supplement. You could otherwise fail to recognize dangers.

If the operating safety of your vehicle is impaired, park the vehicle immediately and safely. Contact a qualified specialist workshop.

The driver display shows the following basic information:

- Speed and engine speed
- Fuel level and coolant temperature
- Indicator and warning lamps

Additional functions available include the following:

- Various menus, such as **Assistance** and **Navigation**
- Status displays for the driving systems
- Display messages
- Information on speed, **Consumption** and **Range**

Some menu content and settings can be changed.

Driver display malfunction

⚠ WARNING Risk of accident if the driver display malfunctions

if the driver display is inoperative or its functions are restricted, you will not receive information about such issues as other function restrictions, speed, current drive range and the status of the electric parking brake.

This will impair operating safety.

- ▶ Stop the vehicle immediately in accordance with the traffic conditions and switch it off. Do not continue driving.
- ▶ Consult a qualified specialist workshop.
- ▶ Have the vehicle transported rather than towed.

Identifying a driver display malfunction

A driver display malfunction can be identified by characteristics such as the following:

- When the vehicle is switched on, the driver display continues to show nothing but a black screen.

- The driver display restarts.
- The content freezes.
- The display stops showing data such as speed. Various indicator and warning lamps are also displayed.

What to do in the event of a driver display malfunction

If the driver display is inoperative or its functions are restricted, stop the vehicle immediately in accordance with the traffic conditions and switch it off. The following procedure is recommended in this eventuality:

- ▶ Stop the vehicle in accordance with the traffic conditions.
- ▶ While the vehicle is stationary, continue to hold the brake pedal down.
- ▶ Press the **P** button on the DIRECT SELECT lever.
- ▶ Apply the parking brake.
- ▶ Slowly release the brake pedal and make sure that the vehicle is secured against rolling away.

- ▶ Press and hold the start/stop button (→ page 182) once for roughly three seconds to switch off the drive system.
 - ▶ Contact a qualified specialist workshop immediately.
 - ▶ Have the vehicle transported rather than towed.
- i** In addition, note the additional information about switching off the vehicle (→ page 182) and the notes on transporting the vehicle (→ page 364).

Operating the driver display

⚠ WARNING Risk of distraction from information systems and communications equipment

If you operate information systems and communication devices integrated in the vehicle when driving, you could be distracted from the traffic situation. This could also cause you to lose control of the vehicle.

- ▶ Only operate this equipment when the traffic situation permits.
- ▶ If you cannot be sure of this, stop the vehicle whilst paying attention to road and traffic conditions and operate the equipment with the vehicle stationary.

Observe the legal requirements for the country in which you are currently driving when operating the driver display.

Scrolling on the menu bar

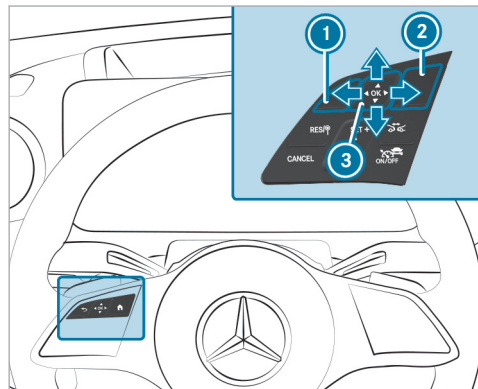

- ① Back button
- ② Main menu button
- ③ Touch Control

The controls on the left of the steering wheel manage the content of the driver display. Swipe with your finger on Touch Control ③ to navigate

vertically or horizontally through the content. Press the Touch Control to confirm your selection.

- ① To operate Touch Control ③ in the most effective way, use the tip of your thumb if possible. You can also set the sensitivity of the Touch Control on the central display.
- ▶ Briefly press main menu button ②.
- ▶ Select a menu by swiping to the left or right on Touch Control ③.
- ▶ **To confirm:** press Touch Control ③.

Driver display menus

Notes on menus on the driver display

⚠ WARNING Risk of distraction from information systems and communications equipment

If you operate information systems and communication devices integrated in the vehicle when driving, you could be distracted from the traffic situation. This could also cause you to lose control of the vehicle.

- ▶ Only operate this equipment when the traffic situation permits.
- ▶ If you cannot be sure of this, stop the vehicle whilst paying attention to road and traffic conditions and operate the equipment with the vehicle stationary.

Observe the legal requirements for the country in which you are currently driving when operating the driver display.

The following menus can be called up via the menu bar on the driver display:

- Understated
- Sport
- Classic
- Navigation
- Assistance
- Offroad (vehicles with 4MATIC)
- Service

On some of these menus, you can choose from a range of information for the center display content.

On most of the menus, you can use **Options** to configure further settings for the menu-specific display content.

You can find further information about the possible settings and selections on the menus in the Digital Operator's Manual.

Sport menu (Mercedes-AMG vehicles)

Driver display:

➔ **Sport**

The **Sport** menu displays information about the engine data, the setup and the temperature of the vehicle.

▶ **To call up the menu:** swipe to the left or right on the Touch Control.

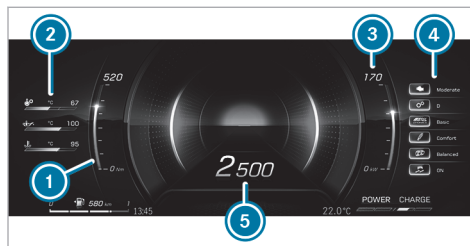

- ① Current torque
 - ② Temperature (transmission oil temperature, engine oil temperature, coolant temperature)
 - ③ Current power output
 - ④ Set-up (drive position, transmission position, AMG DYNAMICS, suspension tuning, exhaust system, ESP®)
 - ⑤ Engine speed
- ⓘ Depending on the equipment, AMG-specific content regarding temperature, setup and engine data will be displayed. You can set the setup display content using the buttons on the multifunction steering wheel or via the MBUX multimedia system . You can also acti-

vate or deactivate ESP® using the steering-wheel button or via the MBUX multimedia system.

Head-up Display

Function of the head-up display

The head-up display projects various content into the driver's field of vision, for example.

You can use the head-up display menu bar to select different contexts, e.g.:

- Minimal
- Sport
- Standard
- Offroad (vehicles with 4MATIC)
- ECO display (depending on model and equipment) (→ page 168)
- Settings
- Head-up display on/off

The following image shows an example of the head-up display. You can choose what content is displayed (→ page 276).

System limits

Visibility is influenced by the following conditions in particular:

- Seat position
- Image position setting
- Ambient light
- Wet road surfaces
- Objects on the display cover
- Polarization in sunglasses

Operating the head-up display

Selecting display content of the head-up display via the menu bar of the driver display

- ▶ Press the main menu button .
- ▶ **To select the menu bar of the head-up display:** swipe upwards on the Touch Control.



Switching between display content on the head-up display



- ▶ Swipe to the left or right on the Touch Control. A preview of the selected display content will appear on the head-up display.
- ▶ **To confirm:** press the  button.

Switching back to the driver display

- ▶ Press the  or  button.

Setting the position and brightness

- ▶ Swipe to the left or right on the Touch Control and select **Settings** on the menu bar of the head-up display.

- ▶ Press the Touch Control. The current position and brightness settings will be displayed as graphics on the head-up display as well as on the driver display.
- ▶ **To adjust the position:** swipe upwards or downwards on the Touch Control.
- ▶ **To adjust the brightness:** swipe to the left or right on the Touch Control. The settings configured for position and brightness will be saved automatically.
- ▶ Press the  or  button to exit the settings.

Switching the head-up display on/off

Driver display:



Switching on

- ▶ Swipe upwards on the Touch Control.
- ▶ Press Touch Control .

Switching off

- ▶ Swipe upwards on the Touch Control.

- ▶ Swipe on the Touch Control and select **Head-up Display**.
- ▶ Press Touch Control **OK**.

Setting the head-up display in the multimedia system

Multimedia system:



Switching the head-up display on/off

- ▶ Select **Head-up Display**.
The head-up display is activated or deactivated.

Vehicles with a 48 V on-board electrical system

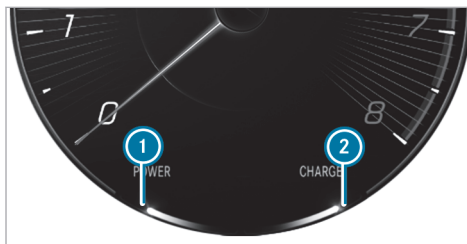

- ① Electric drive support
- ② Recuperation behavior of the electric motor
- ⓘ Due to various system limits, the values displayed may temporarily differ slightly from the actual value.





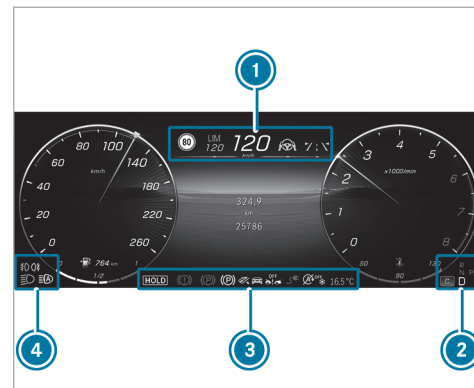









Overview of status indicators on the driver display



The status indicators for the driving and driving safety systems are shown in the ① and ④ areas.



- ④ Pedestrian detection (on assistant display only)
- ② Active Parking Assist is available (→ page 257)
- ③ Active Parking Assist has detected a parking space (→ page 257)
- ① Parking Assist PARKTRONIC deactivated (→ page 254)

278 Driver's display

-  Cruise control (→ page 200)
-  Active Distance Assist DISTRONIC (→ page 202)
-  Specified distance for Active Distance Assist DISTRONIC (→ page 202)
-  Active Brake Assist switched off (→ page 222)
-  Active Brake Assist impaired or not functioning (→ page 222)
-  Active Steering Assist (→ page 212)
-  Active Lane Change Assist (→ page 216)
-  Active Lane Keeping Assist (→ page 230)
-  Active Blind Spot Assist (on assistant display only) (→ page 229)
-  Blind Spot Assist (on assistant display only) (→ page 229)
-  Plug-in hybrid operation activated
-  Haptic accelerator pedal (→ page 169)
-  ECO start/stop function (→ page 166)
-  HOLD function (→ page 197)
-  Adaptive Highbeam Assist (→ page 136)

-  Active Stop-and-Go Assist (→ page 209)
-  Slippery road surface warning

Vehicles with Traffic Sign Assist: detected instructions and traffic signs (→ page 223)

Important information from other driving systems may briefly appear in front of the displayed traffic signs.

Overview and operation

Notes on the MBUX multimedia system

⚠ WARNING Risk of distraction from information systems and communications equipment

If you operate information systems and communication devices integrated in the vehicle when driving, you could be distracted from the traffic situation. This could also cause you to lose control of the vehicle.

- ▶ Only operate this equipment when the traffic situation permits.
- ▶ If you cannot be sure of this, stop the vehicle whilst paying attention to road and traffic conditions and operate the equipment with the vehicle stationary.

You must observe the legal requirements for the country in which you are currently driving when operating the multimedia system. Depending on the equipment, the scope of function and product designation of your MBUX multimedia system may differ from the description and

images in this Operator's Manual. For example, route guidance with augmented reality is not available in all equipment variants.

- ⓘ The functions of your MBUX multimedia system may differ and depend on the following factors:
- Market
 - National version
 - Technical conditions

Functions, services and service aspects provided by Mercedes-Benz and/or third-party providers may no longer be available when the contractual period expires or due to technical conditions. There is therefore no entitlement to the continuous provision of functions and services.

The described functions may be modified, optimized and adapted after the time of going to press.

Mercedes-Benz therefore reserves the right to introduce changes in the following areas:

- Features

- Services
- Service aspects

For these reasons, descriptions and depictions relating to the MBUX multimedia system may, in some cases, differ for your vehicle.

! NOTE Increased surface temperature due to direct sunlight on the central display



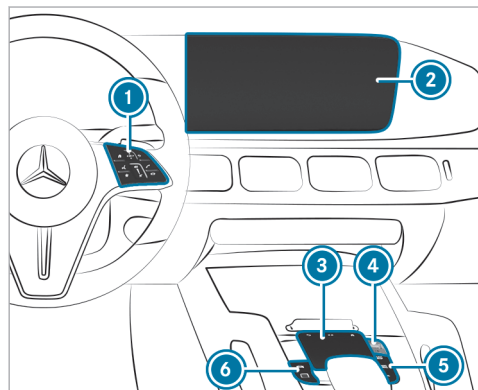

The surface of the central display is very dark. If the display is exposed to direct sunlight, the surface can become very hot.

- ▶ If the central display has been exposed to direct sunlight, allow it to cool down before touching it for a long time.

Overview of the MBUX multimedia system



- ① Touch Control and control panel for the MBUX multimedia system
MBUX stands for Mercedes-Benz User Experience.
 - Operating Touch Control
- ② Media display with touch functionality
 - Home screen overview

- Operating the touchscreen
- ③ Touchpad
Operating the touchpad
- ④ Controller
Turn: adjusts the volume
Press briefly: switches the mute function on/off
Press and hold: switches the MBUX multimedia system or media display on or off
- ⑤ Buttons for navigation , radio/media  and telephone 
- ⑥ Button for vehicle functions  and favorites button 

Further operating options:

- Conducting a dialog with the MBUX Voice Assistant.
- Operating functions contact-free with the MBUX Interior Assistant.
- ① You can find further information about operation as well as about applications and services in the Digital Operator's Manual.

Anti-theft protection

This device is equipped with technical provisions to protect it against theft. Further information on anti-theft protection can be obtained at an authorized Mercedes-Benz Center.

Home screen overview

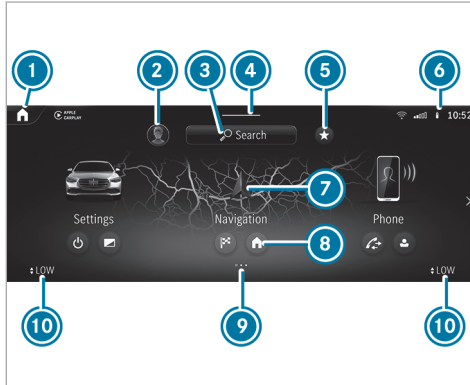

- 1 On the home screen: displays the first three applications
In other displays: calls up the home screen
- 2 Calls up user profile settings and switches user
- 3 Uses the global search
- 4 Calls up the Control Center: pull the bar down

- 5 Calls up favorites
- 6 Displays in the status line
- 7 Calls up applications
- 8 Quick-access to application
- 9 Index points for selected display area
- 10 Calls up the air conditioning menu

The following functions are called up in the Control Center:



- Notifications Center
- Favorites
- Vehicle quick-access

Operating the MBUX multimedia system

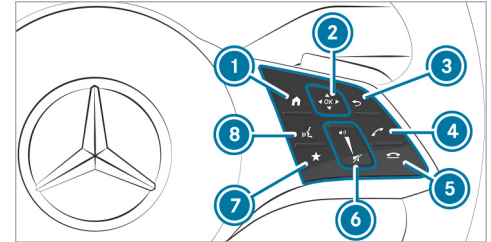
Using Touch Control



- 1 Shows the home screen
- 2 Touch Control
 swipe in the direction of the arrow (navigate)
 Press (confirm)
- 3 Returns to the previous display
- 4 Makes or accepts a call
- 5 Rejects or ends a call
- 6 To increase volume: swipe upwards
To reduce volume: swipe down

-  To switch off the sound: press
- 7**  Calls up favorites
- 8**  Starts the MBUX Voice Assistant
- i** To operate Touch Control **2** in the most effective way, use the tip of your thumb if possible.

You can navigate through menus and lists via the touch-sensitive surface of Touch Control **2** using a **single-finger swipe**, e.g.:

- ▶ **To enter a character:** select a character using the keyboard and press on Touch Control **2**.
- ▶ **To select a menu option:** scroll in a list and press Touch Control **2**.
- ▶ **To move the digital map:** swipe in any direction.

Using the touchscreen



- ▶ **To select a menu item or entry:** tap on a symbol or an entry.
- ▶ **To increase the map scale:** tap twice quickly with one finger.
- ▶ **To reduce the map scale:** tap with two fingers.

- ▶ **To enter characters with the keypad:** tap on a button.
- ▶ **To navigate in menus:** swipe up, down, left or right.
- ▶ **To use handwriting to enter characters:** write the character with one finger on the touchscreen.
- ▶ **To zoom in and out of the map:** move two fingers together or apart.
- ▶ **To enlarge or reduce the size of a section of a website:** move two fingers together or apart.
- ▶ **To turn the digital map:** turn counter-clockwise or clockwise using two fingers.
- ▶ **To move the digital map:** touch the touchscreen and move your finger in any direction.
- ▶ **To save the destination in the digital map:** touch the touchscreen and hold until a message is shown.
- ▶ **To set the volume on a scale:** touch the touchscreen and move your finger to the left or right.

- ▶ **To call up a global menu in the applications:** touch the touchscreen and hold until the **Options** menu appears.

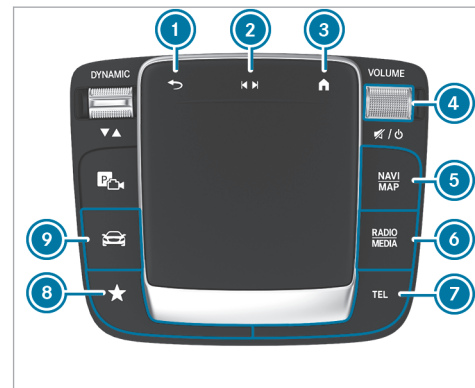
On the touchpad



- 1**  button
Returns to the previous display
- 2**  button

Press: calls up the control menu of the last active audio source

- ③  button

Press: shows the home screen and calls up applications

- ④ Turn: adjusts the volume

Press briefly: switches the mute function on/off

Press and hold: switches the MBUX multimedia system or media display on or off

- ⑤ Calls up navigation or the map

- ⑥ Calls up radio or media

- ⑦ Calls up the telephone

- ⑧ Calls up favorites

- ⑨ Calls up vehicle functions

▶ **To enter a character:** enter a character using the keyboard.

or

▶ Write a character on the touch-sensitive surface of the touchpad.

▶ **To select a menu item or entry:** swipe up, down, left or right and tap on the touchpad.

▶ **To move the digital map:** swipe in any direction.

▶ **To zoom in and out of the map:** move two fingers together or apart.

▶ **To enlarge or reduce the size of a section of a website:** move two fingers together or apart.

▶ **To call up the Notifications Center:** swipe down with two fingers.

▶ **To close the Notifications Center:** swipe up with two fingers.

▶ **To call up the control menu of the last active audio source:** swipe up with two fingers.

Function of the MBUX Voice Assistant

⚠ WARNING Risk of distraction from information systems and communications equipment

If you operate information systems and communication devices integrated in the vehicle when driving, you could be distracted from the traffic situation. This could also cause you to lose control of the vehicle.

▶ Only operate this equipment when the traffic situation permits.

▶ If you cannot be sure of this, stop the vehicle whilst paying attention to road and traffic conditions and operate the equipment with the vehicle stationary.

For your own safety, always observe the following points when operating mobile communications equipment and especially your voice control system:

- Observe the legal requirements for the country in which you are driving.
- If you use the voice control system in an emergency your voice can change and your telephone call, e.g. an emergency call, can thereby be delayed.
- Familiarize yourself with the voice control system functions before starting the journey. Using the MBUX Voice Assistant, vehicle functions and various areas of the MBUX multimedia system can be operated by voice input. The MBUX Voice Assistant is operational approximately half a minute after switching on the vehicle and can be

operated from all seats. Further information and examples of voice commands can be found in the Digital Operator's Manual.

You can use the MBUX Voice Assistant to operate the following functions depending on the vehicle equipment:

- Telephone
- Text messages and e-mails
- Navigation
- Radio and media
- Vehicle functions
- Online functions

Full functionality of the voice control system is only available for you with activation of online voice control.

Conducting a dialog

Starting a dialog

- ▶ Say "Hey Mercedes" to activate the MBUX Voice Assistant. Voice activation must be switched on in the multimedia system.

or

- ▶ Press the  button on the multifunction steering wheel.

A blue line appears in the MBUX multimedia system. The dialog can be started.

For the dialog with the MBUX Voice Assistant, you can use complete sentences of colloquial language as voice commands. Voice activation can also be directly combined with a voice command, e.g. "Hey Mercedes, how fast can I drive?"

Calling up help

- ▶ **For information about the MBUX Voice Assistant:** say "Hey Mercedes, what can you do?"
- ▶ **Digital Operator's Manual:** "Show me the Operator's Manual". The full extent of the Digital Operator's Manual is available when the vehicle is stationary.

Operating functions (examples)

- ▶ **To operate the navigation:** "Search for an Asian restaurant, but not Japanese, in South Manhattan."
- ▶ **To operate the phone:** "Call my father."

- ▶ **To change the system language to English (short command):** "Change language to English".
- ▶ **To operate the radio:** "Show me the list of radio stations."
- ▶ **To operate media:** "Switch on random playback."
- ▶ **To operate vehicle functions:** "Switch the seat heating to level 2."
- ▶ **To operate online functions:** "What's the time in Sydney?"
- ▶ **To ask a question about the vehicle:** "Do I have Blind Spot Assist?"

Overview of the MBUX Interior Assistant

⚠ WARNING Risk of injury from the camera's laser radiation

This product uses a classification 1 laser system. If the housing is opened or damaged, laser radiation may damage your retina.

- ▶ Do not open the housing.

▶ Always have maintenance work and repairs carried out by a qualified specialist workshop.

This product complies with the requirements of the FDA 21 CFR 1040.10 and 1040.11 with exception of the variations according to the FDA Laser Notice No. 50 from 24 June 2007.

The camera is located in the overhead control panel.

If the vehicle is equipped with the MBUX Interior Assistant, selected functions of the multimedia system can be operated contact-free. In addition, the reading light or search light can be switched on or off contact-free.

The MBUX Interior Assistant can differentiate between driver and front passenger interactions.

The MBUX Interior Assistant recognizes specific hand movements and a pose.

System limits, display messages and notes for rectification

The system may be impaired or may not function in the following situations:

- The camera in the overhead control panel may heat up due to operating conditions. As a result the camera may switch off temporarily, particularly during longer periods of operation and at high outside temperatures.
Do not touch or cover the camera and wait until the camera has cooled down and is available again.
- The camera is covered, dirty, fogged up or scratched.

Wait until the camera has cooled down before cleaning the camera lens.

Clean the outside of the camera lens with a dry or damp cotton cloth. Do not use micro-fiber cloths. Do **not** remove the cover when cleaning.

- Recognition can be impaired by reflective clothing, an adverse color of clothing or by accessories, for example.
- Clothing being worn (hat, shawl, scarf) may be limiting the detection range of the camera.
Keep the camera's field of vision clear.
- The camera is not operational.
Consult an authorized Mercedes-Benz Center.

The MBUX Interior Assistant supports the following interactions:

Interaction area	Interaction	Description
In front of the media display or above the touchpad	Proximity to the control element	The Interior Assistant recognizes the approach of your hand towards a control element. Depending on the active application, the display will be adjusted in the media display. Some functions differentiate between driver and front passenger. No specific hand position is required.
Above the center console	Defined pose	A favorite is called up with a defined pose.
Below the inside rearview mirror	Brief up and down movements	With brief up and down movements below the inside rearview mirror the reading light for the driver or the front passenger is switched on or off.
Above the front passenger seat	Stretching out a hand above the front passenger seat	By stretching out a hand above the front passenger seat the search light is switched on. If you withdraw a hand from this area, the search light is switched off again.

Switching the reading light and search light and on or off

Requirements

- **For the reading light:**
 - The function is available when it is dark.
- **For the search light:**
 - The hand movement takes place in the interaction area below the inside rearview mirror.
 - The hand movement takes place in the interaction area above the front passenger seat.
 - The seat belt on the front passenger seat must **not** be inserted in the seat belt buckle.
 - The function is available when it is dark.

Switching the reading light on and off



- ▶ Briefly move a hand up or down beneath the inside rearview mirror. The reading light is switched on or off for the driver or the front passenger.

Switching the search light on and off



- ▶ **To switch on:** reach across the front passenger seat with a hand. The search light is switched on for the driver.
- ▶ **To switch off:** take a hand back away from the front passenger seat. The search light is switched off again.

Information on users, suggestions and favorites

⚠ WARNING Risk of becoming trapped during adjustment of the driver's seat after calling up a driver profile

Selecting a user profile may trigger an adjustment of the driver's seat to the position saved under the user profile. You or other vehicle occupants could be injured in the process.

- ▶ Make sure that when the position of driver's seat is being adjusted using the multimedia system, no people or body parts are in the seat's range of movement.

If there is a risk of someone becoming trapped, immediately stop the adjustment process by:

- ▶ a) Pressing the warning message on the central display.

or

- ▶ b) Pressing a position button of the memory function or a seat adjustment switch in the driver's door. The adjustment process is stopped.

The driver's seat is equipped with an anti-entrapment feature.

If the driver's door is open, the driver's seat will **not** be set after calling up the driver's profile.

User profiles and user-specific content

Prerequisites for the vehicle owner:

- You have a Mercedes me user account.
 - You have a Mercedes me PIN.
 - You have agreed to the terms of use.
 - The vehicle is linked to a Mercedes me user account.
- i** If one of the pre-requisites listed is missing or if no user profile has been selected, the data described in the following section will be saved in the vehicle as the standard setting. Standard settings can be changed by all vehicle users.

User profiles save personal settings. If the vehicle is used by several people, a person can change their profile settings without changing the settings of other users.

You can individualize a user profile in the vehicle using the set-up assistant or using the settings in your user profile. Some settings, e.g. the Mercedes me PIN and a profile photo are made in the Mercedes me App or in the Mercedes me Portal.

User-specific content and applications with personal data are protected by different levels of security. To access protected content, the Mercedes me PIN and, depending on the vehicle equipment, biometric sensors can be used.

- i** The security level is set by the multimedia system and calculated from the combination of all sensor inputs. Some security levels cannot be turned off.
- i** When a user profile is activated, the following personalized comfort systems, for example, can be adjusted or their settings loaded:
- Seat
 - Ambient light
 - Outside mirrors
 - Roller sunblinds
 - Climate control settings

If the user profile is activated when driving, the driver's seat position will not be adjusted.

Depending on the vehicle equipment you can, as a user, save the following settings, for example:

- Driver's seat, steering wheel and mirror settings
- Climate control
- Ambient lighting
- Radio (including station list)
- Suggestions and favorites

Suggestions

The vehicle can learn the habits of the driver. It then makes suggestions regarding navigation destinations, phone numbers and music preferences. The requirements for that are the selection of a user, your consent to the recording of data and sufficient collected data.

Favorites

Favorites offer you quick access to frequently used applications. 100 favorites are available in total.

Configuring users, suggestions and favorites

Requirements:

- The vehicle is stationary.

Multimedia system:



Adding a user

- Select **+** **Add User** .
A QR code is loaded.
- Scan the displayed QR code with the Mercedes me App or any QR code scanner on a mobile device. If the Mercedes me App is not yet installed on your mobile device, you will be directed to the store of your mobile device.
- Follow the directions in the app.
The vehicle is connected with your Mercedes me user account. This automatically creates your user profile in the vehicle.
You will be informed when your user profile is available.

When the vehicle is stationary, the set-up assistant starts automatically after user selection.

Protecting user-specific content and applications

If you add a new user, access protection is already activated for the user profile. The Mercedes me PIN and, depending on the vehicle equipment, biometric sensors are available for access. Biometric sensors in the vehicle must be taught in. The authentication process then takes all taught-in and available sensors into account.

The following user-specific content and applications are protected, for example:

- User selection and user profile settings
- Biometric sensors
The teaching-in of biometric sensors is protected.
- Suggestions
The data and determination of the most probable navigation destinations, media sources, radio stations, contacts and messages are protected.
- ENERGIZING COACH

The recorded health data and their evaluation are protected.

- Mercedes me connect store
The purchase of services is protected.

- Switch **Protect Content** on or off.
- Switch **Access Protection** on or off.

- i** When access protection is switched off, your user profile can be viewed from any seat and changes can be made.
- i** Access protection is switched on or off on a vehicle-specific basis.

Setting up, editing and deleting biometric recognition

The biometric data models are saved in the sensors in the vehicle. If recognition has been taught-in, this sensor serves as a contributory factor for authentication on the multimedia system.

- Select **Protect Content**.
- Select **Voice Recognition**.
- i** If necessary, authenticate yourself on the multimedia system.

Setting up voice recognition

- ▶ Speak the sentence shown on the media display and follow the voice assistant's instructions. If voice recognition was successful, a message appears on the media display. You can unlock your user profile.
- ⓘ Avoid background or disturbing noises during voice recognition.

Deleting biometric data



- ▶ Tap on  behind **Voice Recognition**.
- ▶ Select **Yes**.

Selecting a user

- ⓘ When you call up your driver profile, the driver's seat and the steering wheel can be set. You can cancel the setting process with the following actions:
 - Tap on the **Tap Here to Cancel** message on the media display.
 - Press one of the seat operating buttons in the driver's door.

- ▶ Select **Select User**.
- ▶ Select a user.
- ▶ When requested to do so, authenticate with the Mercedes me PIN or a taught-in biometric characteristic. The user profile is loaded and activated.
- ⓘ If you select **Continue Without Selecting a User**, no specific settings for the user profile are loaded.





Configuring and deleting suggestions

- ▶ Select .
- ▶ Select **Settings**.
- ▶ Select **System**.
- ▶ Select **Suggestions**.
- ▶ Select .
- ▶ Switch the options on or off individually. If an option is switched on and sufficient data has been gathered, personalized suggestions based on your user behavior will be offered to you on the zero layer. These are, for example, navigation destinations visited, phone num-

bers dialed as well as suggestions based on your music preferences.

- ▶ **To delete collected suggestions:** select .
- ▶ Select **Yes**. The suggestions are reset.

Adding favorites from categories

- ▶ Select .
- ▶ Select .
- ▶ Select .
- ▶ Select  **Create New Favorite**.
- ▶ Select the category.
- ▶ Select a favorite.

System settings

Overview of the system settings menu

In the system settings menu, you can make settings in the following menus and control elements:

- Display
 - Display brightness

- Control elements
 - Keyboard language and handwriting recognition
 - Sensitivity of Touch Control
 - Haptic operation for the touchscreen
- MBUX Voice Assistant
- MBUX Interior Assistant
- Sound
 - Entertainment
 - Navigation and traffic announcements
 - Telephone
 - Voice amplification
- Data protection
- Connectivity
 - Wi-Fi, Bluetooth®, NFC
- Time & date
- Language
- Units for distance
- System PIN
- Suggestions

- Software update
- System reset

Overview of software updates

Important software updates may be necessary for the security of your multimedia system's data. Install these updates, or else the security of your multimedia system cannot be ensured.

The multimedia system displays a corresponding message when a software update is available.

If the **Automatic Online Update** option is active, software updates are downloaded automatically. If the option is deactivated, you will be informed of new software updates once. The software updates are available for downloading for a limited period of time.

Carrying out a software update:

- You can start software updates via the communication module.
- You can start software updates via a WLAN hotspot.

- You can start map updates from an external medium.

- ① Online software updates cannot be performed via external WLAN hotspots that are encrypted via TKIP.
- ① If the WLAN hotspot requires logging in via the browser, once the connection is successfully established the browser will open in order to start the update. To start the download follow the instructions in the browser.
- ① To complete software updates via the communication module, the vehicle must be connected with the Internet and a Mercedes me user account.
- ① To complete software updates via WLAN, the vehicle must be connected to an external WLAN hotspot.

A software update consists of three steps:

- Downloading or copying of the data required for installation
- Installation of the downloaded software update
- Activation of the downloaded software update

- ❗ It may be necessary to restart the MBUX multimedia system after completion of a software update.
- ❗ While some software updates are being downloaded, the multimedia system cannot be operated and the vehicle functions may be restricted.
- ❗ Some software updates require a safe vehicle status for the installation to be completed. They can only be carried out in a safely parked vehicle with the vehicle switched off.

For software updates requiring a safe vehicle status: when the last installation step is reached, a message appears on the media display after the vehicle is switched off. Follow the step-by-step instructions on the media display to complete the installation.

There are software updates that can only be installed when the vehicle is safely parked, there are no more people in the vehicle and the vehicle is locked.

Availability of the driver and media display

During the installation of software updates, it is not possible to use the vehicle, media display and

driver display. You may receive the following display message when an installation is running:

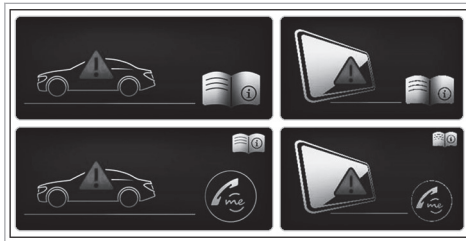

- ❗ The display message does not appear every time a software update is installed.

In rare cases, an error can occur during the installation. The multimedia system automatically attempts to restore the previous version.

If it is not possible to restore the previous version, the display message shown above appears every time the vehicle is started.

Failure of the driver display

If the driver display fails or there is a malfunction, you may not recognize limitations in the functions

of systems relevant to safety or the speed display, for example. This may impair the operating safety of the vehicle. Park the vehicle safely as soon as possible and notify a qualified specialist workshop. (→ page 429)

Further information about software updates can be found at <https://me.secure.mercedes-benz.com>

Failure of the media display

If the media display fails or the display message shown above is shown continuously, several systems such as the rear view camera, Parking Assist PARKTRONIC or climate control are no longer available. Drive on carefully and consult a specialist workshop as soon as possible.

Setting up a Wi-Fi hotspot

Requirements:

- The Wi-Fi function is activated on the multimedia system and the communication device to be connected.

- The communication device to be connected supports at least one of the types of connection described.

The connection types shown depend on the device to be connected. The function must be supported by the multimedia system and by the device to be connected. The type of connection must be selected on the multimedia system and on the device to be connected.

- ⓘ Some functions may first need to be activated on the communication device being connected. More detailed information can be found in the manufacturer's operating instructions.
- ⓘ The use of the vehicle data tariff by external devices is not available in all countries.

Multimedia system:

→  » Settings » System
» Internet and Bluetooth

- ⓘ The availability of the functions is country-dependent.
- ▶ Select **Wi-Fi**.
The controller is to the right: Wi-Fi is switched on.

When the Wi-Fi function is switched on, you can connect the multimedia system with external hotspots or make it available as a hotspot for external devices.

When the Wi-Fi function is switched off, it is not possible to establish a hotspot connection.

- ⓘ Depending on the vehicle equipment, you can obtain an Entertainment Package via the Mercedes me Store. In order to use the data package included, you must conclude your own contract with a mobile phone network provider via the Mercedes me App. This can be terminated at any time and incurs no costs. Without this contract it is not possible to use the services included in the previously acquired Entertainment Package. The availability of this option is dependent on the country. If the data package option is not available or can be upgraded, you can purchase data volume directly from the mobile phone network provider for a fee. The availability of this option is dependent on the country.
- ⓘ The use of the vehicle data tariff by external devices is not available in all countries.

Using the multimedia system as a Wi-Fi hotspot

- ▶ Select **MBUX Hotspot**.
- ▶ Select one of the following connection options.

Connecting using a QR code

Requirement: an app for scanning the QR code is installed on the device being connected.

Alternatively: the device being connected has an integrated QR code scanner (see the manufacturer's operating instructions).

- ▶ Scan the QR code shown.
The WLAN connection is established.

Connecting using NFC

- ▶ Activate NFC on the device to be connected.
- ▶ When the NFC symbol is displayed in the **MBUX Hotspot** menu, hold the device to be connected to the NFC interface.
- ▶ Follow the instructions on the device.
The WLAN connection is established.

Connecting using a security key

- ▶ Select the vehicle from the device to be connected. The vehicle is displayed with the **MBUX XXXXX** network name.
- ▶ Enter the security key shown on the device to be connected.
- ▶ Confirm the entry.

Generating a new security key

- ▶ Select the **Generate New Security Key** option in the **MBUX Hotspot** menu.
- ▶ Confirm the prompt with **Yes**.
A new security key is generated.

A connection will be established with the newly created security key.

- ⓘ When a new security key is generated, all existing Wi-Fi connections are then disconnected. If the WLAN connections are re-established, the new security key must be entered.

Using a mobile communication device as a Wi-Fi hotspot (tethering)

- ⓘ This function is country-dependent.
 - ▶ Select the **Manage Internet Access** option in the **Internet and Bluetooth** menu.
 - ⓘ The Wi-Fi function on the mobile phone and Internet access via Wi-Fi must be activated (see the manufacturer's operating instructions).
 - ▶ Select **Search for Access**.
 - ▶ Select the network.
 - ▶ Log in to the Wi-Fi network.
- or
- ▶ Select the mobile phone with the  Wi-Fi symbol.

- ⓘ With external Wi-Fi hotspots, which are encrypted via TKIP, online software updates cannot be carried out via the external Wi-Fi hotspot.

System language

Notes on the system language

This function allows you to determine the language for the menus and navigation announcements. The selected language affects the characters available for entry. The navigation announcements are not available in all languages. If a language is not available, the navigation announcements will be in English.

Setting the language

Multimedia system:

→  **Settings** **System**
 ▶ **Language**

Setting the system language

A list of the available system languages is shown.

- ▶ Select a language.
The system language is switched to the selected language.

Resetting the multimedia system (reset function)

⚠ WARNING Risk of accident due to failure of central display functions

While the multimedia system is reset, its functions, such as the rear view camera, are not available.

▶ Only reset the multimedia system when the vehicle is stationary.

Requirements:

- The vehicle is switched on.
- The vehicle is stationary.

Multimedia system:

→  >> Settings >> System >> Reset

When resetting the system, personal data and settings are deleted, for example:

- Connected devices
- Individual user profiles
- Biometric data

- ① The data used and saved in the multimedia system by the driver assistance systems is deleted.
 - ▶ Select **Reset**.
A query appears asking if the system should really be reset.
 - ▶ Select **Yes**.
The multimedia system is reset to the factory settings. The multimedia system is restarted after the system reset.
- ① Due to data protection, as well as the function of individual driving systems and driving safety systems, it is a requirement to carry out a complete system reset before selling the vehicle or transferring it to a third party, or after use as a hire car.

Off-road menu

Overview of the Offroad menu in the MBUX multimedia system

The **Offroad** menu provides an overview of the most important, relevant data for off-road driving, as well as functions to assist driving off-road and

the possibility to record tracks for subsequent re-use or for sharing with other drivers.

Cockpit

This tab provides an overview of the most important data. Content is displayed in different tiles that can be changed using directional arrows or swipes. In addition, this menu contains buttons for quick-access to certain vehicle functions relevant to off-road operation.

Displayed data are, for example:

- Artificial horizon
- Compass
- Altitude
- Steering angle of the front and rear wheels
- Torque and power
- Tire pressure and temperature
- Transparent hood

Further information on the Cockpit tab (→ page 296).

Assistant

This tab provides access to settings for the recovery mode and individual wheel control.

Further information on the Offroad Assistant tab (→ page 296)

Score

In the **Score** tab, a journey can be analyzed and evaluated with a numerical score in order to determine how good the off-road driving was carried out.



Further information on the **Score** tab (→ page 297).

Setting the off-road menu in the multimedia system

Multimedia system:

→  **Offroad** **Cockpit**

Setting displays in the central display

▶ Press ,  or on the display itself to jump to the next display.

Quick-access: activating or deactivating Parking Assist PARKTRONIC

▶ Press  to switch the function on or off.

 Further information on Parking Assist PARKTRONIC (→ page 251).

Quick-access: activating or deactivating ESP® (Electronic Stability Program)

▶ Press  to switch the function on or off.

 Further information on ESP (→ page 194).

Quick-access: activating or deactivating manual shifting

▶ Press  to switch the function on or off.

 Additional information on manual gearshifting (→ page 177).

Quick-access: activating or deactivating DSR (Downhill Speed Regulation)

▶ Press  to switch the function on or off.

 Further information on DSR (→ page 209).

Quick-access: setting the vehicle level

▶ Press  to raise or lower the vehicle.

 Additional information about vehicle level (→ page 233).

 The availability of individual functions depends on country and equipment.

Setting Off-road Assist**Requirements**

- the vehicle is stationary
- the off-road level is set
- off-road drive program  is selected
- the vehicle is switched on
- all doors and the hood are closed
- the transmission is not engaged in position **P**
- there is no trailer coupled
- the vehicle is outdoors
- the detected lateral inclination of the vehicle must not exceed approx. 15°
- the system is within its operating temperature

- the on-board voltage is sufficiently high

Multimedia system:

Offroad **Assistance**

Recovery mode

Recovery mode assists the driver when pulling away on rough terrain, such as sand or snow.

- ▶ Select **Recovery Mode**.
- ▶ Select **Start**.
Recovery mode is activated.
- ▶ Select **Stop** to stop recovery mode.

Recovery mode is automatically deactivated in the following situations:

- you are actually traveling faster than 9 mph (15 km/h)
- after a running time of 30 seconds
- it is detected that an object has hit the underbody of the vehicle hard
- not all conditions are met

Further information on recovery mode (→ page 240).

Individual wheel control

Individual wheel control enables the vehicle level to be set separately for each wheel.

- ▶ Select **Individual Wheel Ctrl.**
- ▶ Set the vehicle level for the desired wheel.

You can also use the touchscreen to set the level for two or more wheels at the same time.

- ▶ Select **Reset** to set all wheels to the default setting.

Individual wheel control is automatically deactivated in the following situations:

- you are traveling faster than 9 mph (15 km/h)
- it is detected that an object has hit the underbody of the vehicle hard
- not all conditions are met

Further information on individual wheel control (→ page 240).

Displaying the Offroad Score

Multimedia system:

Offroad **Score**

Use the Offroad Score only for off-road driving and not on public roads. When choosing the route, take into account the vehicle characteristics, the ground conditions and your driving skills. Do not let the system distract you from what is happening on the route.

- ▶ Select **Offroad Score**.
A menu appears. You can start a new trip.

Further functions are available in the lower menu bar:

- Display the current trip via the route symbol.
- Display a list of all notes for the current trip using the list icon.

In the list, a note is displayed with a time stamp, the number of points currently achieved and the note text.

- Display the ranking by clicking on the symbol for the winner's podium.

The ranking list shows the following information:

- Profile name and profile picture (if available)
- The number of points obtained
- Date and time of the completed trip
- The places for gold, silver and bronze

Starting or ending a new trip

The "Start new trip" function is available when the vehicle is stationary and the engine is running.

- ▶ Select **Start new trip**.

The display "Trip and tips" appears.

The following information is displayed:

- the vehicle inclination in longitudinal direction in percent (%)
- the lateral inclination of the vehicle in degrees (°)
- the currently achieved score for the ongoing trip
- a tip for the upcoming driving maneuver

- ▶ **To stop the display:** select **End trip**.

An evaluation of the trip is displayed. It shows the achieved score and a message, for example **Great job!**.

Navigation and traffic

Notes on navigation

Route guidance with augmented reality

- ⚠ **WARNING** Risk of accident and injury as a result of distraction, incorrect depiction or wrong interpretation of the display

The camera image of the augmented reality display is not suitable as a guide for driving.

- ▶ Always keep an eye on the actual traffic situation.
- ▶ Avoid extended observation of the camera image.

- ⚠ **WARNING** Risk of accident and injury due to imprecise positioning of additional information

The additional information from the augmented reality display may be inaccurate and is not a substitute for observing and assessing the actual driving situation.

- ▶ Always keep an eye on the actual traffic situation when carrying out all driving maneuvers.

Switching navigation on

Multimedia system:



- ▶ Alternatively, press the  button on the steering wheel on the right (→ page 281). The zero layer with the digital map is displayed.

Navigation overview

Digital map

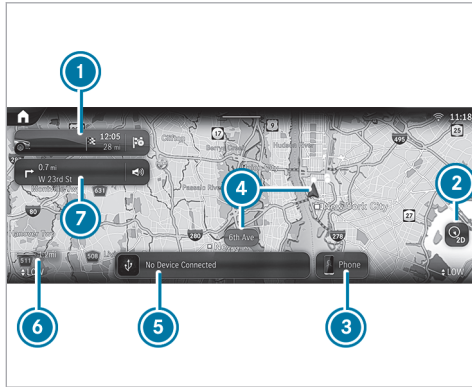

- ① Navigation module (reduced view)
Route guidance active:
The navigation module shows the information relevant to the route in the zoomed-out view, e.g. the destination or a traffic delay

⊗ Ends the current route guidance

Tapping opens the navigation module and displays the route overview

- ② Sets map orientation  and map type
- ③ Calls up the telephone menu
- ④ Current vehicle position (vehicle symbol or arrow)
- ⑤ Calls up entertainment applications
- ⑥ Elevation and map scale
- ⑦ Navigation window shows the next maneuver (zoomed out view) or the route monitor (zoomed in view)

Route guidance active: route monitor shows, e.g. route sections, upcoming driving maneuvers with lane recommendations, destination, traffic delays, 3D images at freeway exits, online content

Pressing ② several times changes the map orientation in this order:

- 2D and to the north
- 2D and in the direction of travel
- 3D and in the direction of travel

- Map with complete route
- ① If the map is moved, the map switches between 3D direction of travel and 2D north orientation.

The following map types ② are available:

- Daytime display
- Night-time display
- Satellite map
- ① If you notice a problem with the digital map you can report this under <https://mapfeedback.here.com/#/report>.

Navigation module (expanded view)

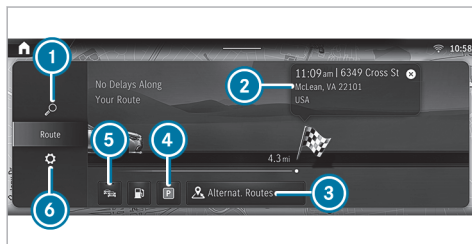

Example: route guidance is active

- ① Enters an address or POI
- ② Destination and time of arrival beneath that the current distance to the destination and the checkered flag
- ③ Alternative routes
- ④ Searches for parking
- ⑤ Switches traffic information display on or off
- ⑥ Makes settings for [View](#), [Messages & Acoustic Signals](#) and [Route](#)

Overview of the toll system

❗ The toll system is optional equipment and is not available in all vehicles.

Debiting of toll charges at freeway toll gates is facilitated with an electronic payment system.

The toll system uses RFID (Radio Frequency Identification) for data transfer between the control unit and the toll station.

The toll system is initially switched off at the factory.

The control unit is in the vehicle glove box.

In order to be able to use the toll system, it must have been registered by the customer and activated by the service provider:

- Activate the toll system in the settings of the MBUX multimedia system or on the control unit.
- There are two ways to register and activate:
 - In the Mercedes me App, register the unit identification number of the control unit and activate the toll system.

- Alternatively, you can register and activate via the [Toll Service](#) app.

Activation of the toll system can take up to 48 hours after registration.

When the toll system is activated, the automatic detection of the number of vehicle occupants is initially switched off at the factory. The number of vehicle occupants is preset with one person.

The following applies for roads on which toll charges are dependent on the number of vehicle occupants:

- If the automatic detection of the number of vehicle occupants is switched off, the number of vehicle occupants must be selected manually. This ensures correct toll accounting.
- The number of vehicle occupants can be transmitted automatically. In the process, the number of seat belts worn is determined.

If the number of detected persons does not correspond with the number of persons actually in the vehicle, the number of persons must be manually selected.

The standard setting of one person does not need to be changed for roads which require toll payment regardless of the number of vehicle occupants.

The toll system enables the payment of toll charges in many states of the USA.

i In Mexico, for example, the toll system can be registered and activated for journeys to the USA.

Notices

- You can only use the toll system once registration and activation are complete.
- Drive at the prescribed vehicle speed in the toll lane.
- Mercedes-Benz recommends operation using the MBUX multimedia system. Alternatively, this can also be done on the control unit in the glove box.
- For safety reasons, entries should be made while the vehicle stationary.
- For further information, please consult the Mercedes me App or an authorized Mercedes-Benz Center.

Or call 1-800-FOR-MERCEdes (in the USA) or 1-800-387-0100 (in Canada).

For information on how to register and activate the toll system, see the Digital Operator's Manual.

Entering a destination

Requirements:

- **For the online search:**
 - There is an Internet connection.
 - Mercedes me connect is available.
 - You have set up a user account in the Mercedes me Portal.
 - The vehicle is connected with the user account and you have accepted the terms of use.
 - Further information can be found at: <https://www.mercedes.me>
 - The service is available.
 - The service has been activated at an authorized Mercedes-Benz Center.

i If Online Search is not available, the search is performed using the data of the digital map.

Multimedia system:

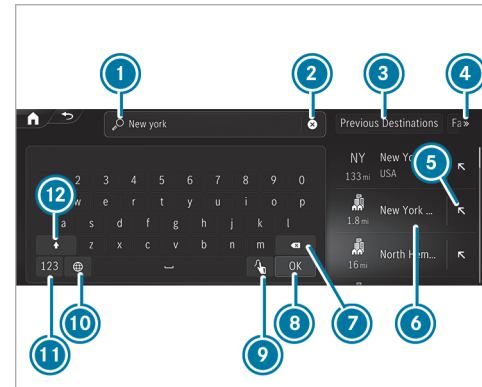

Example: entering a POI or address

- 1 Input line with current entry
- 2 Deletes an entry
- 3 Selects previous destinations

- ④ Displays and selects additional destination searches
- ⑤ Adopts the search result in the input line and continues the search
- ⑥ Search result
- ⑦ Deletes the last character entered
- ⑧ Hides the keypad
- ⑨ Switches to handwriting recognition
- ⑩ Sets the written language
- ⑪ Switches to digits and special characters
- ⑫ Switches to upper-case or lower-case letters

If available, selecting the  symbol starts the MBUX Voice Assistant.

- ▶ Enter the destination in ①. The entries can be made in any order. The search results are displayed in a list.
- ① Online search results for POIs may contain additional information, for example opening times and ratings. The information is provided by an online map service. This online function is not available in all countries.

- ① You can enter a destination as a three-word address from what3words. This option is not available in all countries.

▶ Hide the keyboard with .

▶ Select the destination in the list. The following menu shows the selected destination with the address information and a corresponding map section.

The menu enables the route to be calculated.

- ① Observe the notes on the MBUX multimedia system (→ page 279).

Calculating a route and using settings for route guidance



Example: detailed display

- ① Calls up alternative routes
- ② Calculates the route and starts route guidance
- ③ Selects a point of interest in the vicinity of the destination
- ④ Destination address

After selection of a destination the route is be calculated.

▶ Select one of the options.



Calling up alternative routes

- ▶ Select **Routes**.
- ▶ Select an alternative route.

Starting route guidance

- ▶ Select  **Let's Go!**.

Calling up the detailed display with destination address



- ▶ Pull the bar above  upwards. Depending on the destination selection and availability, online content, for example ratings and weather information, is shown. If the destination is in a different time zone, a message is displayed.
- ▶ **To share a destination:** select  **Share**. This option allows you to scan the displayed QR code.
- ▶ **To save a destination as a favorite:** select  **Favorite** and then an option.
- ▶ **To call up an Internet address:** if a web address is available, select **www**.

- ▶ **To call the destination:** if a telephone number is available, select **Call**.

Searching for POIs in the vicinity of the destination shown

- ▶ Select **In The Vicinity**.
- ▶ Search using categories, enter a search entry or search for a personal POI.

Selecting a route type

- ▶ In the navigation module (expanded view), select  (→ page 299).
- ▶ Select **Route**. The route is calculated as a fast route with a short journey time. Trailer mode is available if a trailer has been coupled with the vehicle. If available, you can select online routes. Traffic announcements for the route are taken into account via **Reroute Based on Traffic** .
- ▶  Trailer mode and online routes are not available in all countries and for all vehicles.

Calculating alternative routes

- ▶ In the navigation module (expanded view), select .
- ▶ Select **View**.
- ▶ Switch on **Route Overview after Start**. Alternative routes are calculated for every route.

Selecting alternative routes

- ▶  If **Route Overview after Start** has been switched on and a route has been calculated, the function is available.
- ▶ In the navigation module (expanded view), select **Alternative Routes**.
- ▶ When the alternative routes have been calculated, display the route in the navigation window by swiping to the right or left.
- ▶ Select **Start**.

Activating a commuter route

❶ A user profile has been created and **Allow Destination Suggestions** has been activated in the user options (→ page 289). Route guidance is not active.

▶ In the navigation module (expanded view), select .

▶ Select **Route**.

▶ Switch on **Commuter Route**.

The navigation system automatically detects that the vehicle is on a commuter route.

For the daily commuter route, traffic incidents on the route are also reported when driving without active route guidance.

▶ **To select or delete a commuter route:** select **Start** or .

Avoiding or using route sections, e.g. highways or ferries

▶ In the navigation module (expanded view), select .

▶ Select **Route**.

▶ Select **Avoid Options**.

▶ Activate or deactivate the avoid option.

Activating route guidance with augmented reality

▶ In the navigation module (expanded view), select .

▶ Select **View**.

▶ Select **Augmented Reality Video**.

▶ Activate or deactivate **Augmented Reality Video**.

The camera's video image is shown on the media display before a turning maneuver. The video image includes additional information.

Showing property information for route guidance with augmented reality

Route guidance with augmented reality is activated.

▶ In the navigation module (expanded view), select .

▶ Select **View**.

▶ Select **Augmented Reality Video**.

▶ Activate **Street Names** and **House Numbers**. During route guidance, the activated options are shown as additional information in the camera image.

Using map functions

Multimedia system:



Increasing map scale

▶ When the map is shown, tap twice quickly with one finger on the media display.

or

▶ Move two fingers apart on the media display.

Decreasing map scale

▶ Tap with two fingers on the media display.

or

▶ Move two fingers together on the media display.

Moving the map

- ▶ When the map is displayed, swipe in any direction with one finger on the media display.
- ▶ **To reset the map to the current vehicle position:** select  **Center**.

Selecting map orientation

- ▶ Tap repeatedly on the  compass symbol on the map.
- The map orientations changes in this order:
- The 2D map view is displayed so that north is always at the top.
 - The 2D map view is aligned to the direction of travel.
 - The 3D map view is aligned to the direction of travel.
 - The map shows the complete route.

Using services

Requirements:

- There is an Internet connection.
- Mercedes me connect is available.

- You have set up a user account in the Mercedes me Portal.
- The vehicle is connected to a user account and you have accepted the conditions of use for the service.
Further information can be found at: <https://www.mercedes.me>
- The service is available.
- The service has been activated at an authorized Mercedes-Benz Center.

Multimedia system:



Showing traffic information

Route guidance uses traffic reports via Live Traffic Information.

- ▶ In the navigation module (expanded view), select  (→ page 299).
- ▶ Select **View**.
- ▶ Activate **Traffic**.

- ▶ Activate **Traffic Incidents** and **Free Flowing Traffic**.

Traffic incidents, for example roadworks, local area reports (e.g. fog) and warning messages, are shown on the route.

The traffic delay is displayed for the current route. The smallest value for the display for traffic delays is a minute.

- ▶ **i** For more information on Live Traffic Information, please refer to the Digital Operator's Manual.

Displaying hazard warnings

If hazard warnings are available these can be shown as symbols on the map. The display depends on the settings for the **Traffic Incidents** option.

- ▶ In the navigation module (expanded view), select  (→ page 299).
- ▶ Activate or deactivate **Traffic Incidents**. If the option is activated, all of the symbols are shown.
- ▶ If the option is deactivated, the symbols are only shown when there is a hazard warning.

The following hazards may be shown on the map:

- Accidents and breakdowns
- Slippery roads, fog, crosswinds and heavy rain
- Hazards reported manually
- Vehicle with active hazard warning light
- Roadworks
- Additional hazards (if available)

Displaying online map contents

- ▶ In the navigation module (expanded view), select .
- ▶ Select **View**.
- ▶ Switch on an online service, e.g. **Weather**. Current weather information is displayed on the navigation map, e.g. temperature or cloud cover.
The service information is not shown in all map scales, e.g. weather symbols.

Parking service

! **NOTE** Vehicle damage due to failure to observe the maximum permissible clearance height

If the vehicle height exceeds the maximum permissible clearance height, the roof and other vehicle parts may be damaged.

- ▶ Please observe the maximum clearance height indicated.
- ▶ If the vehicle exceeds the permissible clearance height, do not drive in.
- ▶ Take the modified vehicle height into account in the case of roof superstructures or other carrier systems.

! **NOTE** Vehicle damage due to failure to observe local information and parking conditions

The data is based on the information provided by the respective service providers.

Mercedes-Benz does not guarantee the accuracy of the information provided in relation to the car park or parking area.

- ▶ Always observe the local information and conditions.

i This service is not available in all countries.

- ▶ In the navigation module (expanded view), select  and switch on **Parking**.

- ▶ Tap on **P** the map.

or

- ▶ In the route overview, select **P** **Parking Spaces**.
- ▶ Select the search position and search filter, e.g. **Near Destination** and **Parking Garages**. The map shows car parks suited to the selected settings.
- ▶ Select a parking option. The map shows the parking options in the vicinity.

The following information is displayed (if available):

- Destination address, distance from current vehicle position and arrival time
 - Information on the parking garage/car park
For example, opening times, parking charges, current occupancy, maximum parking time, **maximum access height**.
The maximum access height shown by the parking service does not replace the need for observation of the actual circumstances.
 - Available payment options (Mercedes pay, coins, bank notes, cards)
 - Details on parking tariffs
 - Number of available parking spaces
 - Payment method (e.g. at parking meters)
 - Services/facilities at the parking option
 - Telephone number
- ▶ Calculate the route (→ page 302).

Notes on the dashcam

! **NOTE** Risk of legal consequences due to violation of legal regulations and data protection provisions

You are legally responsible for operation and use of the dashcam functions.

The legal requirements relating to operation and use of the dashcam can vary depending on the country in which the dashcam is operated.

This function is not permitted in all countries.

- ▶ Before using the dashcam, read up on the content of the legal regulations, in particular the data protection requirements in the respective country of use.
- ▶ Observe the legal regulations, in particular the data protection requirements.

- ① Observe the following instructions for safe operation:
 - Only use FAT32 or exFAT formatted USB storage devices.

- Use USB-IF certified USB storage devices.
USB-IF is a non-profit corporation and stands for USB Implementers Forum. Based on the USB specification, USB-IF certifies, for example, USB versions, corresponding cables and plugs as well as energy supply processes via the USB interface.
- USB storage devices may be damaged if often or permanently overwritten at high speed. Mercedes-Benz recommends a high-quality external SSD drive.
The abbreviation SSD stands for Solid State Drive.
- ① The file size and therefore the duration of single recording is limited by the limitations of the USB flash drive format. So FAT32 formatted USB flash drives do not allow files larger than 4 GB, for example.
When the file size is reached, the recording stops and you receive a notification.
- ① The following functions are available in the Gallery app:
 - Switching write protection on or off

- Deleting video files

Selecting a USB device for a video recording with the dashcam

Requirements:

- At least one USB device is connected with the multimedia system .

Multimedia system:

→  » Apps » Dashcam

- ▶ Select the USB symbol.
- ▶ Select the USB device.

- ⓘ When USB devices contain multiple partitions, recorded video files are not always displayed in the recording list.
Mercedes-Benz recommends that you use USB devices with one partition.

Starting or stopping a loop recording with the dashcam

Requirements:

- For recording and saving a video file: a USB device is connected with the multimedia system.
- The vehicle is switched on.

Multimedia system:

→  » Apps » Dashcam

- ▶ If several USB devices are connected with the multimedia system, select a USB device (→ page 308).
If no USB device is selected, a selection is made automatically when recording starts.
- ▶ **To select recording mode:** select **Loop Recording**.
Loop Recording continuously records short video files. When the memory is full, recording is continued automatically. In doing so, the oldest video file is written over.

- ▶ **To start:** select **Start Recording**.
The length of the recording is shown. The **Do not remove the storage medium during recording. Before removing the storage medium, eject it first.** message appears. The video file is stored on the USB device.

- ▶ **To end:** select **End Recording**.

- ⓘ In some countries, geo-coordinates (longitude and latitude) are shown in the video image. For technical reasons, the geo-coordinates may show greater inaccuracies.

A message may appear in the following cases:

- The camera is not functional, the **Camera Unavailable** message appears.
Have the camera checked in an authorized Mercedes-Benz Center.
- If the country border indication has been switched on.
- If an outdoor recording is started with the camera app during a dashcam recording, the dashcam recording pauses and resumes automatically after the camera recording is finished. A notification to this effect is displayed.

Starting or stopping individual recordings with the dashcam

Requirements:

- For recording and saving a video file: a USB device is connected with the multimedia system.
- The vehicle is switched on.

Multimedia system:

→  » Apps » Dashcam

- ▶ If several USB devices are connected with the multimedia system, select a USB device (→ page 308).
If no USB device is selected, a selection is made automatically when recording starts.
- ▶ **To select recording mode:** select **Individual Recording**.
Individual Recording stops recording when the memory limit is reached. An individual recording is automatically protected against being overwritten.

▶ **To start:** select **Start Recording**.
The length of the recording is shown. The **Do not remove the storage medium during recording. Before removing the storage medium, eject it first.** message appears. The video file is stored on the USB device.

▶ **To end:** select **End Recording**.

- ⓘ In some countries, geo-coordinates (longitude and latitude) are shown in the video image. For technical reasons, the geo-coordinates may show greater inaccuracies.

A message may appear in the following cases:

- **Individual Recording:** the memory is full or there are only a few minutes recording time available. The video recording stops or will be stopped imminently.
Change the USB device or delete a video file.
- The camera is not functional, the **Camera Unavailable** message appears.
Have the camera checked in an authorized Mercedes-Benz Center.
- If the country border indication has been switched on.

- If an outdoor recording is started with the camera app during a dashcam recording, the dashcam recording pauses and resumes automatically after the camera recording is finished. A notification to this effect is displayed.

Telephone

Telephony

Notes on telephony

⚠ WARNING Risk of distraction from operating integrated communication equipment while the vehicle is in motion

If you operate communication equipment integrated in the vehicle when driving, you could be distracted from the traffic situation. This could also cause you to lose control of the vehicle.

- ▶ Only operate this equipment when the traffic situation permits.
- ▶ If you cannot be sure of this, stop the vehicle whilst paying attention to road

and traffic conditions and operate the equipment with the vehicle stationary.

⚠ WARNING Risk of accident from operating mobile communication equipment while the vehicle is in motion

Mobile communication devices distract the driver from the traffic situation. This can also cause the driver to lose control of the vehicle.

- ▶ As a driver, only operate mobile communication devices when the vehicle is stationary.
- ▶ As a vehicle occupant, use mobile communication devices only in the designated area, e.g. in the rear passenger compartment.

You must observe the legal requirements for the country in which you are currently driving when operating the multimedia system and mobile communication equipment in the vehicle.

⚠ WARNING Risk of injury due to objects being stowed incorrectly

If objects in the vehicle interior are stowed incorrectly, they can slide or be thrown around and hit vehicle occupants. In addition, cup holders, open stowage spaces and mobile phone receptacles cannot always retain all objects within.

There is a risk of injury, particularly in the event of sudden braking or a sudden change in direction.

- ▶ Always stow objects so that they cannot be thrown around in such situations.
- ▶ Always make sure that objects do not protrude from stowage spaces, parcel nets or stowage nets.
- ▶ Close the lockable stowage spaces before starting a journey.
- ▶ Always stow and secure heavy, hard, pointed, sharp-edged, fragile or bulky objects in the trunk/cargo compartment.

Observe the additional information on stowing mobile communications devices correctly:

- Loading the vehicle (→ page 113)

Bluetooth® connection:

The menu view and the available functions in the telephone menu are in part dependent on the Bluetooth® profile of the connected mobile phone. If the mobile phone supports all the following Bluetooth® profiles, the full range of features is available:

- PBAP (Phone Book Access Profile)
 - The contacts on the mobile phone are shown automatically on the multimedia system.
- MAP (Message Access Profile)
 - The mobile phone message functions can be used on the multimedia system.
- HFP (hands-free profile)
 - Wireless telephony is available on the multimedia system.
- SAP (SIM Access Profile)

- The car telephone has access to the SIM card data and dials into the mobile phone network via the exterior antenna.

Irrespective of this, Bluetooth® audio functionality can be used with any mobile radio unit.

For information on the range of functions of the mobile radio unit to be connected, see the manufacturer's operating instructions.

Network connection:

The following cases can lead to the call being disconnected while the vehicle is in motion:

- You switch into a transmission/reception station, in which no communication channel is free.
- The SIM card used is not compatible with the network available
- A mobile phone with "Twincard" is logged into the network with the second SIM card at the same time

The multimedia system supports calls in HD Voice® for improved speech quality. A requirement for this is that the mobile phone and the

mobile phone network provider of the person you are calling support HD Voice®.

Depending on the quality of the connection, the voice quality may fluctuate.

Further information can be obtained from an authorized Mercedes-Benz Center or at: <https://www.mercedes-benz.com/connect>.

Telephone menu overview

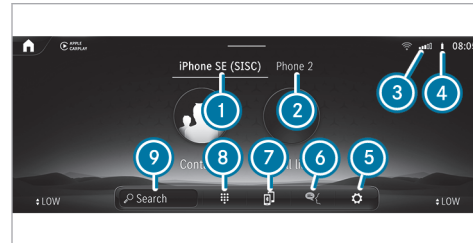

- 1 Bluetooth® device name of the currently connected mobile phone/of the mobile phone
- 2 Bluetooth® device name of the currently connected mobile phone/of the mobile phone (two phone mode)

- 3 Signal strength of the mobile phone network
- 4 Battery status of the connected mobile phone
- 5 Options
- 6 Messages
- 7 Calls up devices
- 8 Numerical pad
- 9 Starts contact search

Telephony operating modes overview

Depending on your equipment, the following telephony operating modes are available:

- A mobile phone is connected to the multimedia system via Bluetooth®.
- Two mobile phones are connected with the multimedia system via Bluetooth® (two phone mode).
 - You can use all the functions of the multimedia system with both mobile phones.

Connecting a mobile phone

Requirements

- Bluetooth® is activated on the mobile phone (see the manufacturer's Operator's Manual).

- Bluetooth® is activated on the multimedia system.

Multimedia system:

→ Home → Phone → Settings → Devices
→ Devices

Searching for a mobile phone

- ▶ Select **Connect New Device**.

Connecting a mobile phone

- ▶ Select a mobile phone.
A code is displayed in the multimedia system and on the mobile phone.
- ▶ If both codes match, confirm the code on the mobile phone.

Functions in the telephony menu

In the telephony menu you have the following functions, for example:

- Making calls, e.g.:
 -  Accepting a call
 -  **End Call**
 - Answering a call with a message
-  **Conference**
 - Accepting or rejecting a waiting call
- Managing contacts, e.g.:
 - Downloading mobile phone contacts
 - Managing the format of a contact's name
 - Deleting favorites
- Receiving and sending messages, e.g.:
 - Using the read-aloud function
 - Dictating a new message

Mercedes me Apps

Mercedes me calls

Making a call via the overhead control panel

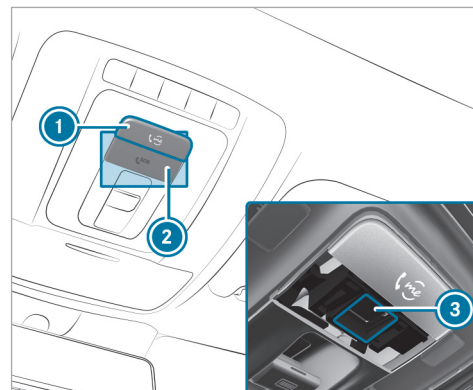

- ① me button for service or information calls
- ② SOS button cover
- ③ SOS button (emergency call system)

Making a Mercedes me call

- ▶ Press me button ①.

Making an emergency call

- ▶ To open the cover of SOS button ②, press it briefly.
- ▶ Press and hold SOS button ③ for at least one second.

If a Mercedes me call is active, an emergency call can still be triggered. This has priority over all other active calls.

Information about the Mercedes me call using the me button

A call to the Mercedes-Benz Customer Center has been initiated via the me button in the overhead control panel or the multimedia system (→ page 312).

Using the voice dialog system you access the desired service:

- Accident and Breakdown Management
- Mercedes-Benz Customer Center for general information about the vehicle

You can find information on the following topics:

- Activation of Mercedes me connect
- Operating the vehicle
- Nearest authorized Mercedes-Benz Center
- Other products and services from Mercedes-Benz

Data is transferred during the connection to the Mercedes-Benz Customer Center (→ page 315).

Calling the Mercedes-Benz Customer Center using the multimedia system

Requirements

- Access to a GSM network is available.
- The contract partner's GSM network coverage is available in the respective region.
- The vehicle must be switched on so that vehicle data can be transferred automatically.

Multimedia system:



- ▶ Call **Mercedes me connect**.

After confirmation, the multimedia system sends the required vehicle data. The data transfer is shown in the display.

Then you can select a service and be connected to a specialist at the Mercedes-Benz Customer Center.

Calling the Mercedes-Benz Customer Center after automatic accident or breakdown detection

Requirements:

- The vehicle has detected an accident or breakdown situation (→ page 188).
- The vehicle is stationary.
- The hazard warning lights are switched on.

ⓘ This function is not available in all countries.

The vehicle can detect accident or breakdown situations under certain circumstances.

Requirements for collision detection in the context of accident recovery:

- The vehicle is equipped with an anti-theft alarm system (ATA) (code 551).
- The vehicle is equipped with the interior protection (code 882).
- The vehicle is equipped with the Anti-Theft Protection Package (code P54).
- The collision detection service with theft notification has been activated on Mercedes me connect.

If a collision is detected when the tow-away alarm is primed on a locked vehicle, you will receive a notification in the multimedia system when you switch the vehicle on.

The message informs you about the potentially affected area of the vehicle and the strength of the collision.

In the event an accident or breakdown is detected, the emergency guide shows safety notes in the multimedia system display. This may take a few seconds.

- ❗ The availability of collision detection depends on the vehicle.

After quitting the emergency guide display on the multimedia system, a prompt appears asking whether you would like to get support from the Mercedes-Benz Customer Center.

▶ Select **Call**.

- After your agreement, or if the Mercedes me connect service "Accident and Breakdown Management" is active, the vehicle data is transferred automatically (→ page 316).
- The Mercedes-Benz Customer Center takes your call and organizes the breakdown and accident assistance.

You may be charged for these services.

- ❗ Depending on the severity of the accident, an automatic emergency call can be initiated. This has priority over all other active calls (→ page 320).
- ❗ In addition, if the Mercedes me connect service "Telediagnosics" is active, a similar prompt can appear after a delay in the event

of a breakdown. If you are already in contact with the Mercedes-Benz Customer Center or have already received support, this prompt can be ignored or declined.

- ❗ If you answer the prompt for support from the Mercedes-Benz Customer Center with **Call Later**, the message will be hidden and appear again later. The prompt triggered by the Mercedes me connect service "Telediagnosics", can either be confirmed or declined. After being declined, this will not be shown again.

■ Arranging a service appointment via a Mercedes me call

If you have activated the maintenance management service, relevant vehicle data is transferred automatically to the Mercedes-Benz Customer Center. You will then receive individual recommendations regarding the maintenance of your vehicle.

Regardless of whether you have consented to the maintenance management service, the multimedia system reminds you after a certain amount of

time that a service is due. A prompt appears asking if you would like to make an appointment.

▶ **To arrange a service appointment:** select **Call**. After your consent, the vehicle data is transferred and the Mercedes-Benz Customer Center takes your preferred appointment date. The information is then sent to your desired service outlet.

This will contact you to confirm the appointment and if necessary consult about the details.

ⓘ If you select **Call Later** after the service message appears, the message is hidden and reappears at a later time.

■ Data transferred during a Mercedes me call

If you initiate a service call using Mercedes me, data is transferred to enable targeted advice and an efficient service.

The following requirements must be fulfilled for the transfer of the data:

- The vehicle is switched on.
- The required data transfer technology is supported by the mobile phone network provider.

- The quality of the mobile connection is sufficient.

Multi-stage transfer depends on the following factors:

- Reason for the initiation of the call
- The available mobile phone transmission technology
- The activated Mercedes me connect services
- The service selected in the voice control system

ⓘ The scope of the data transmitted depends on the vehicle model and vehicle equipment. For technical reasons, not all data is available at all times.

■ Data transfer if Mercedes me connect services are not activated

If no Mercedes me connect services are activated, the following data is transferred:

- Vehicle identification number
- Time of the call
- Reason for the initiation of the call

- Confirmation of the data protection prompt
- Country indicator of the vehicle
- Set language for the multimedia system
- Telephone number of the communication platform installed in the vehicle

If a call is made for a service appointment via the service reminder, the following data is also transmitted:

- Current mileage and maintenance data

If a call is made after automatic accident or breakdown detection using the multimedia system, the following data is also transmitted:

- Current mileage and maintenance data
- Current vehicle location

If Accident and Breakdown Management is called via the voice control system, the following data can also be called up from the vehicle by the Mercedes-Benz Customer Center:

- Current vehicle location

Data processing

The data transmitted within the scope of the call is deleted from the processing system after the call is finished, in so far as this data is not being used for other activated Mercedes me connect services.

The incident-specific data is processed and stored in the Mercedes-Benz Customer Center and, if required to process the incident, forwarded to the service partner authorized by the Mercedes-Benz Customer Center. Take note of the data protection information on the Mercedes me Internet page <https://www.mercedes.me> or in the recorded message immediately after calling the Mercedes-Benz Customer Center.

- ❗ The recorded message is not available in every country.

Mercedes me connect

Information on Mercedes me connect

Mercedes me connect consists of multiple services.

You can use the following services via the multimedia system and the overhead control panel, for example:

- Accident and Breakdown Management (me button or situation-dependent display in the multimedia system)
- Mercedes-Benz Emergency Call System (automatic emergency call and SOS button)

The Mercedes me connect Accident and Breakdown Management and the Mercedes-Benz emergency call center are available to you around the clock.

The me button and the SOS button can be found on the vehicle's overhead control panel (→ page 312).

You can also call the Mercedes-Benz Customer Center using the multimedia system (→ page 313).

Please note that Mercedes me connect is a Mercedes-Benz service. In emergencies, first call the national emergency services using the standard national emergency service telephone numbers. In emergencies, you can also use the

Mercedes-Benz emergency call system (→ page 320).

Please note the Mercedes me connect terms of use and the data protection information for Mercedes me connect. You can find these in your Mercedes me user account.

Further information about Mercedes me connect services can be obtained in the Mercedes me Portal: <https://me.secure.mercedes-benz.com>

Information on Mercedes me connect Accident and Breakdown Management

- ❗ Accident and Breakdown Management is not available in every country. Contact an authorized Mercedes-Benz Center to find out whether this function is available in your country.

The Accident and Breakdown Management can include the following functions:

- Supplement to the Mercedes-Benz emergency call system (→ page 320)

If necessary, the contact person at the Mercedes-Benz emergency call center forwards the call to Mercedes me connect Acci-

dent and Breakdown Management. Forwarding the call is however not possible in all countries.

- Breakdown assistance by a technician on location and/or the towing away of the vehicle to the nearest authorized Mercedes-Benz Center

You may be charged for these services.

- Addition to the emergency guide after automatic accident or breakdown detection (→ page 313)

In the event of a breakdown or accident, further vehicle data is sent which enables optimal support by the Mercedes-Benz Customer Center and the authorized service partner or breakdown assistance.

- Addition to the Mercedes me connect service Telediagnosics

With the Telediagnosics function, specific wear and failure reports are recorded by the service provider, in so far as these can be clearly interpreted and are available through the monitoring of components that are subject to diagnostics.

If your vehicle detects a breakdown or threat of a breakdown, you may be prompted via the multimedia system to contact the Mercedes-Benz Customer Center for further help. This prompt in the multimedia system only appears when the vehicle is stationary.

- ⓘ These services are subject to technical restrictions such as the mobile phone coverage, mobile network quality and the ability of the processing systems to interpret the transferred data. In some circumstances, this can result in delays or the failure of the information to appear in the multimedia system.

Please note that the service and breakdown call is a Mercedes-Benz service. In emergencies, be sure to contact the usual national emergency number first or use the Mercedes-Benz emergency call system (→ page 319).

More information about Mercedes me connect services can be obtained in the Mercedes me Portal: <https://me.secure.mercedes-benz.com>

■ Data transferred during Mercedes me connect call services

The data transferred during a Mercedes me connect call depends on:

- The reason for initiation of the call
- The service that is selected in the voice control system
- The activated Mercedes me connect services

You can find out which data is transferred when using the services in the currently valid Mercedes me connect terms of use and the data protection information for Mercedes me connect. You can find these in your Mercedes me user account.

Overview of the Mercedes me & Apps menu

When you log in with a user account to the Mercedes me Portal, then services and offers from Mercedes-Benz will be available to you.

For more information consult an authorized Mercedes-Benz Center or visit the Mercedes me Portal: <https://me.secure.mercedes-benz.com>

- ① Make sure you always keep the Mercedes me Apps updated.

You can call up the menu using **Apps** in the multimedia system.

In the **Apps** menu, the following options can be available:

- Connecting the vehicle with the **Mercedes me** user account
- Deleting a connection between a user account **Mercedes me** and the vehicle
- Calling up the Mercedes me services
- Calling up apps such as In-Car Office or the web browser depending on availability

Web browser overview



- ① Previous website
- ② Next website
- ③ Update
- ④ URL
- ⑤ Adds/removes bookmarks
- ⑥ Options
- ⑦ Settings

- ① Under **[...]** you have the following options:

- **Tabs**
- **Bookmarks & History**
- **Reading Mode**

- **Share Link**
- **Share Content**
- **Request Mobile Website**

- ① Websites cannot be shown while the vehicle is in motion.

Overview of Smartphone Integration

With Smartphone Integration, you can use certain functions on your mobile phone via the multimedia system display.

Only one mobile phone at a time can be connected via Smartphone Integration to the multimedia system. Also for use with two phone mode with Smartphone Integration, only one additional mobile phone can be connected using Bluetooth® with the multimedia system.

The full range of functions for Smartphone Integration is only possible with an internet connection. The appropriate application must be downloaded on the mobile phone to use Smartphone Integration. The mobile phone must be switched on and connected to the multimedia system via the USB port using a suitable cable.

Apps for Smartphone Integration:

- Apple CarPlay® (wireless connection via Bluetooth® also possible)
- Android Auto (wireless connection via Bluetooth® also possible)

i For safety reasons, the first activation of Apple CarPlay® or Android Auto on the multimedia system must be carried out when the vehicle is stationary with the parking brake.

You can start Smartphone Integration using the **Devices** menu.

You can end Smartphone Integration via the **Devices** or by disconnecting the connecting cable between the mobile phone and multimedia system.

i Mercedes-Benz recommends disconnecting the connection via the device manager or the connecting cable only when the vehicle is stationary.

Overview of transferred vehicle data

When using Smartphone Integration, certain vehicle data is transferred to the mobile phone. This

enables you to get the best out of selected mobile phone services. Vehicle data is not directly accessible.

The following system information is transmitted:

- Software release of the multimedia system
- System ID (anonymized)

The transfer of this data is used to optimize communication between the vehicle and the mobile phone.

To do this, and to assign several vehicles to the mobile phone, a vehicle identifier is randomly generated.

This has no connection to the vehicle identification number (VIN) and is deleted when the multimedia system is reset (→ page 295).

The following driving status data is transmitted:

- Transmission position engaged
- Distinction between parked, standstill, rolling and driving
- Day/night mode of the driver's display
- Drive type

The transfer of this data is used to alter how content is displayed to correspond to the driving situation.

The following position data is transmitted:

- Coordinates
- speed
- Compass direction
- Acceleration direction

The mobile phone uses this data to improve the accuracy of navigation, for example, when driving through a tunnel.

Mercedes-Benz emergency call system

Information on the Mercedes-Benz emergency call system

Your vehicle is equipped with the Mercedes-Benz emergency call system ("eCall"). This feature can help save lives in the event of an accident. eCall in no way replaces assistance provided from dialing 911.

Mercedes-Benz eCall only functions in areas where mobile phone coverage is available from the wireless service providers. Insufficient network coverage from the wireless service providers may result in an emergency call not being transmitted.

eCall is a standard feature in your Mercedes-Benz vehicle. In order to function as intended, the system relies on the transmission of data detailed in the Transmitted Data section that follows.

To disable eCall, a customer must visit an authorized Mercedes-Benz Service department to deactivate the vehicle's communication module.

Deactivation of this module prevents the activation of any and all Mercedes me connect services. After the deactivation of eCall, automatic emergency call and manual emergency call will not be available.

The vehicle must be switched on before an automatic emergency call can be made.

- ① eCall is activated at the factory.
- ① eCall can be deactivated by an authorized Mercedes-Benz dealer. Please note that in the event ownership of the vehicle is transferred

to another owner in its deactivated state, eCall will remain deactivated unless the new owner visits an authorized Mercedes-Benz dealership to reactivate the system.

Overview of the Mercedes-Benz emergency call system

eCall can help to reduce the time between an accident and the arrival of emergency services at the site of the accident. It helps locate an accident site in places that are difficult to access. However, even if a vehicle is equipped with eCall, this does not mean the system is ON. As such, eCall does not replace dialing 911 in the event of an accident.

An emergency call can be made automatically or manually.

Only make emergency calls if you or others are in need of rescue. Do not make an emergency call in the event of a breakdown or a similar situation.

Information on the display:

SOS NOT READY: the vehicle is not on or eCall not available.

During an active emergency call, <schar> appears in the display.

You can find more information on the regional availability of eCall at: <https://www.mercedes-benz-mobile.com/extra/ecall/>

- ① If there is a malfunction of the emergency call system, the loudspeakers, microphone, air bag or the SOS button, for example, are faulty.

You can recognize a malfunction in the emergency call system by the following displays:

- A corresponding message appears on the driver display.
- The SOS button lights up red continuously.

Triggering an automatic Mercedes-Benz emergency call

Requirements:

- The vehicle is switched on.
- The starter battery is sufficiently charged.

The Mercedes-Benz emergency call system triggers an emergency call automatically in the following cases:

- After activation of the restraint systems such as air bags or Emergency Tensioning Devices after an accident
- After an automatically initiated emergency stop by Active Emergency Stop Assist

The emergency call has been made:

- A voice connection is made to the Mercedes-Benz emergency call center.
- A message with accident data is transmitted to the Mercedes-Benz emergency call center.

The Mercedes-Benz emergency call center can transmit the vehicle position data to one of the emergency call centers.

The SOS button in the overhead control panel flashes until the emergency call is finished.

It is not possible to immediately end an automatic emergency call.

If no connection can be made to the emergency services either, a corresponding message appears in the media display.

▶ Dial the local emergency number on your mobile phone.

If an emergency call has been initiated:

- Remain in the vehicle if the road and traffic conditions permit you to do so until a voice connection is established with the emergency call center operator.
- Based on the call, the operator decides whether it is necessary to call rescue teams and/or the police to the accident site.
- If no vehicle occupant answers, an ambulance is sent to the vehicle immediately.

Triggering a manual Mercedes-Benz emergency call

▶ **To use the SOS button in the overhead control panel:** press the SOS button at least one second long (→ page 312).

or

▶ **To use voice control:** use the voice commands of the MBUX Voice Assistant.

The emergency call has been made:

- A voice connection is made to the Mercedes-Benz emergency call center.
- A message with accident data is transmitted to the Mercedes-Benz emergency call center. The Mercedes-Benz emergency call center can transmit the vehicle position data to one of the emergency call centers.
- Remain in the vehicle if the road and traffic conditions permit you to do so until a voice connection is established with the emergency call center operator.
- Based on the call, the operator decides whether it is necessary to call rescue teams and/or the police to the accident site.

If no connection can be made to the emergency services, a corresponding message appears in the central display.

▶ Dial the local emergency number on your mobile phone.

Ending an unintentionally triggered manual Mercedes-Benz emergency call

▶ Select  on the multifunction steering wheel. Depress button for several seconds.

Data transfer of the Mercedes-Benz emergency call system

In the event of an automatic or manual emergency call the following data is transmitted, for example:

- Vehicle's GPS position data
- GPS position data on the route (a few hundred meters before the incident)
- Direction of travel
- Vehicle identification number
- Vehicle drive type
- Number of people detected in the vehicle
- Whether Mercedes me connect is available or not
- Whether the emergency call was initiated manually or automatically
- Time of the accident

- Language setting on the multimedia system

Data transmitted is vehicle information. For any questions about the collection, use and sharing of the eCall system data, please contact MBUSA's Customer Assistance Center at 800-FOR-MERC.

For Canada, please contact MBC's Customer Assistance Center at 1-800-387-0100.









Customer requests for covered information should be submitted via the same channels.





For accident clarification purposes, the following measures can be taken up to an hour after the emergency call has been initiated:

- The current vehicle position can be determined.
- A voice connection to the vehicle occupants can be established.

Radio & media

Overview of the symbols and functions in the media menu







Symbol	Designation	Function
	Play	Select to start or continue playback.
	Rest	Select to pause the playback.
	Repeat a track	Select to repeat the current track or the active playlist. <ul style="list-style-type: none"> • Select once: the active playlist is repeated. • Select twice: the current track is repeated. • Select three times: the function is deactivated.
	Random playback	Select to play back the tracks in random order.
	Skip forwards/back	Select to skip to the next or to the previous track.
	Additional options	Select to show additional options.
	Categories	Select to show or search through available categories such as playback lists, albums or artists.
	Search	Select to search in the active menu. You can search for artists, genres or moods, for example.

Symbol	Designation	Function
	Settings	Select to make settings.
	Home	Select to return to the home screen.
	Messaging	Select to call up messaging.
	Full screen	Select to switch to full screen mode.

The following functions and settings are available in the **Media** menu:





- Connecting external data storage media with the multimedia system (e.g. using USB or Bluetooth®)
- Playing back audio or video files

Overview of the symbols and functions in the radio menu

Symbol	Designation	Function
	Home	Select to return to the home screen.
	Messaging	Select to call up messaging.
	Skip forwards/back	Select to skip to the next or to the previous station.
	Settings	Select to have further options shown. The setting options are country-dependent.
HD	HD radio™	Select to switch the HD Radio™ function on or off. This function is not available in all countries.
	Station list	Select to have the station list shown.
	Search	Select to search in the active menu. You can search for artists, genres or moods, for example.

Additional functions of TuneIn Radio

-  A relatively large volume of data can be transmitted when using TuneIn Radio.

Symbol	Designation	Function
	Settings	The following additional settings are available in the TuneIn Radio menu: <ul style="list-style-type: none"> • Selecting stream • Logging on to or out of the TuneIn account
	Favorites	Select during playback to save the station currently set as a favorite.
	Play/Pause	Select to start, stop or continue playback.
	Browse	Select to choose a category and then a radio station.



Additional functions of the satellite radio

SIRIUS XM® satellite radio offers more than 175 digital-quality radio channels providing commercial-free music, sports, news and entertainment, for example. SIRIUS XM® satellite radio employs a fleet of high-performance satellites to broadcast

around the clock throughout the USA and Canada. The satellite radio program is available for a monthly fee. Information about this can be obtained from a Sirius XM® Service Center and at <https://www.siriusxm.com> (USA).

 Sirius, XM and all related marks and logos are trademarks of Sirius XM Radio Inc. and its subsidiaries. All other marks, channel names

and logos are the property of their respective owners. All rights reserved.

Symbol	Designation	Function
	Settings	The following additional settings are available in the satellite radio menu: <ul style="list-style-type: none"> • Activate child safety lock to lock channels with adult content • Set alarm program for music and sport alerts • Create TuneMix lists to listen to music seamlessly
	Play	Select to start or continue playback.
	Rest	Select to pause the playback.

Depending on the frequency band selected, different functions are available to you.

Select the desired frequency band in the radio menu head runner.

Calling up Tuneln Radio

Requirements:

- There is a user account at <https://www.mercedes.me>.
- The vehicle is linked to the Mercedes me user account.
- The Tuneln Radio service is activated in the Mercedes me portal.

- The data volume is available.
Depending on the country, data volume may need to be purchased.
 - A fast Internet connection for data transmission free of interference.
-  New data volume can be purchased **directly from a mobile phone network provider** via the Mercedes me Portal.

- ⓘ The functions and services are country-dependent. For more information, consult an authorized Mercedes-Benz Center.

Multimedia system:

→  » **Radio**

- ▶ Select **TuneIn Radio**.
The TuneIn menu appears. The last station set starts playing.
- ⓘ The connection quality depends on the local mobile phone reception.

Setting up satellite radio

Requirements:

- Satellite radio equipment is available.
- Registration with a satellite radio provider has been completed.
- If registration is not included when purchasing the system, your credit card details will be required to activate your account.

Multimedia system:

→  »  **Radio** » **SiriusXM**
» 

- ▶ Select **Service Information**.
The service information screen appears showing the radio ID and the current subscription status.
- ▶ Establish a telephone connection.
- ▶ Follow the service staff's instructions.
The activation process may take up to ten minutes.
- ⓘ You can also have the satellite service activated online. To do so, please visit <https://www.siriusxm.com> (USA) or <https://www.siriusxm.ca> (Canada).

Music and sport alerts

Multimedia system:

→  »  **Radio** » **SiriusXM**
»  » **Alerts**

Setting music and sport alerts

This function enables you to program an alert for your favorite artists, tracks or sporting events. Music alerts can be saved whilst a track is being played and sport alerts can be saved during a live game. You can also specify sport alerts via the menu option. The system then continuously searches through all the channels.

- ▶ Set a music or sports alert, to be informed of matches in the Live program.

Activating messages for a category

- ▶ Select a category and activate .

Adding messages for a category

- ▶ Select a category and add a message .

- ▶ Select **Artist Alerts** or **Track Alerts** in the dialog window.
The message is set for the activated track and artist. If a match is found, a prompt appears asking whether you wish to change to the station.

Deleting messages in a category

- ▶ Select a category, mark the desired messages and delete .

or

- ▶ Do not mark any messages and delete all entries .

Standard sound system

The following functions are available:

- Equalizer
 - Treble, mid-range and bass
- Balance and fader
- Volume
 - Automatic adjustment

Sound settings

Overview of functions in the sound menu

The setting options and functions available depend on the sound system installed. You can find out which sound system is installed in your vehicle in the Digital Operator's Manual.

ASSYST PLUS service interval display

Function of the ASSYST PLUS service interval display

The ASSYST PLUS service interval display on the driver's display provides information on the remaining time or distance before the next service due date.

You can hide this service display using the back button  on the steering wheel.

Depending on how the vehicle is used, the ASSYST PLUS service interval display may shorten the service interval, e.g. in the following cases:

- Mainly short-distance driving
- When the engine is often left idling for long periods
- In the event of frequent cold start phases

Mercedes-Benz recommends avoiding such operating conditions.

You can obtain information concerning the servicing of your vehicle from a qualified specialist workshop, e.g. an authorized Mercedes-Benz Center.

Displaying the service due date

Driver's display:



The next service due date is displayed.

▶ **To exit the display:** press the  back button on the steering wheel.

Bear in mind the following related topic:

- Operating the driver's display (→ page 273).

Information on regular maintenance work

! **NOTE** Premature wear through failure to observe service due dates

Maintenance work which is not carried out at the right time or incompletely can lead to increased wear and damage to the vehicle.

- ▶ Adhere to the prescribed service intervals.
- ▶ Always have the prescribed maintenance work carried out at a qualified specialist workshop.

Notes on special service requirements

The prescribed service interval is based on normal operation of the vehicle. Have the maintenance work carried out more often than prescribed if operating conditions are difficult or the vehicle is subject to increased stress.

The ASSYST PLUS service interval display is only an aid. It is the responsibility of the driver of the vehicle to have maintenance work carried out more often than prescribed due to actual operating conditions and/or stresses.

Examples of arduous operating conditions:

- Regular city driving with frequent intermediate stops
- Mainly short-distance driving
- Frequent operation in mountainous terrain or on poor road surfaces
- When the engine is often left idling for long periods
- Operation in particularly dusty conditions and/or if air-recirculation mode is frequently used

In these or similar operating conditions, have the interior air filter, air filter, engine oil and oil filter, for example, changed more frequently. If subject to increased stress, check the tires more. Further information can be obtained at a qualified specialist workshop.

Battery disconnection periods

The ASSYST PLUS service interval display can calculate the service due date only when the battery is connected.

- ▶ Display and note down the service due date on the driver display before disconnecting the battery (→ page 330).

Maintenance Management

Notes about Maintenance Management

If the Maintenance Management service is activated, relevant data is automatically transferred to the Mercedes-Benz customer center.

The customer center transmits the data to the service partner that you have entered on the

Mercedes me website at: <http://www.mercedes.me>. You will then receive individual recommendations regarding the maintenance of your vehicle.

- ① The calculation of the optimal transmission time of the maintenance request to the service partner is subject to technical limitations that may cause the maintenance recommendation to be perceived as too early or too late or not to be made at all. In this case, you can conveniently arrange a maintenance appointment with the customer center via the maintenance reminder in the multimedia system.
- ① Maintenance Management and the maintenance reminder in the multimedia system are not available in every country. Contact an authorized Mercedes-Benz Center to find out whether this function is available in your country.

Data transferred when using Maintenance Management

When the service is activated, relevant data is automatically transferred to determine the required scope of maintenance as well as malfunction detection and malfunction rectification.

Details on data transfer can be found in the data protection information for the Mercedes me connect services. These can be found at: <https://www.mercedes.me> under "My Account", "Data Protection & Legal Notice".

- ① Maintenance Management and the maintenance reminder in the multimedia system are not available in every country.



Telediagnosis

Notes about Telediagnosis

- ① This service is not available in all countries. The vehicle can detect if certain wear parts need to be replaced or if malfunctions have occurred in vehicle systems. If the Telediagnosis service is activated, relevant data is automatically transmit-

ted to the manufacturer. If fault conditions are detected by the vehicle system self-diagnosis, the system transmits recommendations for action to the Mercedes-Benz customer center depending on the fault detected. The customer center transmits the data to the service partner that you have entered on the Mercedes me website at: <http://www.mercedes.me>.

For selected faults, the notification that a malfunction has been detected may appear in the multimedia system with a request to contact the Mercedes-Benz customer center. From this message, a call can be made directly to the customer center for assistance.

-  The transmission of a notification to the multimedia system depends on the country, vehicle model and equipment and requires a fast data connection, over which the service provider has no influence.
-  Reliable fault detection is subject to technical limitations. Therefore, only a limited selection of faults can be detected and recommendations for action transmitted to the customer center and the service partners. Mercedes-Benz AG is continuously working on the

expansion of this service. The fault detection depends on the country, vehicle model and equipment.

Data transferred when using Telediagnosics

When the service is activated, relevant data is automatically transferred to determine the required scope of maintenance as well as malfunction detection and malfunction rectification.

Details on data transfer can be found in the data protection information for the Mercedes me connect services. These can be found at: <https://www.mercedes.me> under "My Account", "Data Protection & Legal Notice".



-  The scope of the transmitted data depends on the vehicle model and its equipment. For technical reasons, not all data is available at all times.

Engine compartment

Opening and closing the hood

 **WARNING** Risk of accident due to driving with the hood unlocked

The hood may open and block your view.

-  Never release the hood when driving.
-  Before every trip, ensure that the hood is locked.

 **WARNING** Risk of accident and injury when opening and closing the hood

The hood may suddenly drop into the end position.

There is a risk of injury for anyone in the hood's range of movement.

-  Do not open or close the hood if there is a person in the hood's range of movement.

⚠ WARNING Risk of burns when opening the hood

If you open the hood in the event of an overheated engine or fire in the engine compartment, the following situations may occur:

- You may come into contact with hot gases.
 - You may come into contact with other escaping hot operating fluids.
- ▶ Before opening the hood, allow the engine to cool down.
 - ▶ In the event of a fire in the engine compartment, keep the hood closed and call the fire service.

⚠ WARNING Risk of injury due to moving parts

Components in the engine compartment may continue to run or start unexpectedly even when the drive system is switched off.

Observe the following if you must open the hood:

- ▶ Switch off the vehicle.
- ▶ Never touch the danger zones surrounding moving components, e.g. the rotation area of the fan.
- ▶ Remove jewellery and watches.
- ▶ Keep items of clothing and hair away from moving parts.

⚠ WARNING Risk of injury from touching live components

The ignition system and the fuel injection system operate with a high voltage. You could receive an electric shock.

- ▶ Never touch components of the ignition system or fuel injection system when the vehicle is switched on.

The live components include the following, for example:

- Ignition coils
- Fuel injectors

- Electric lines to the ignition coils and the fuel injectors

⚠ WARNING Risk of burns from hot component parts in the engine compartment

Certain component parts in the engine compartment can be very hot, e.g. the engine, the cooler and parts of the exhaust system.

- ▶ Allow the engine to cool down and only touch component parts described in the following.

⚠ WARNING Risk of injury from using the windshield wipers when the hood is open

If the windshield wipers start moving when the hood is open, you could be trapped by the wiper linkage.

- ▶ Always switch off the windshield wipers and the vehicle first if you need to open the hood.

Opening the hood

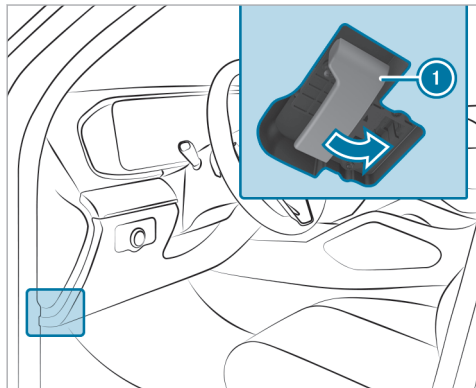

- ▶ To release the hood, pull on handle ①.

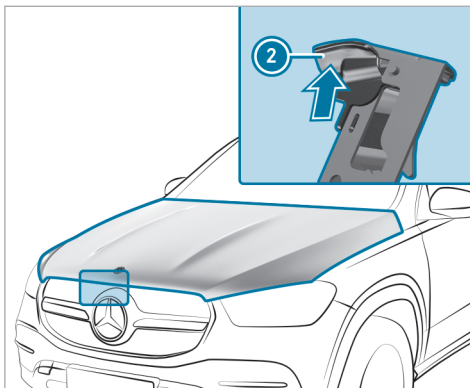

- ▶ Push handle ② of the hood catch upwards and lift the hood until it opens automatically.

Closing the hood

! **NOTE** Damage to the hood due to pressing the hood closed with your hand

If the hood is closed manually, there is a risk of dents.

- ▶ Do not close the hood manually.

- ▶ Lower the hood to a height of around 8 in (20 cm) and then allow it to fall, applying a little force as you let it go.
- ▶ If the hood can still be lifted slightly, open the hood again and close it with a little more force until it engages correctly.

Engine oil

Checking the engine oil level using the driver's display

Requirements

- The engine has been warmed up.
- The vehicle is parked on a level surface.
- The engine is running at idle speed.
- The hood is closed.

Determining the engine oil level can take up to 30 minutes with a normal driving style and even longer with an active driving style.

Driver display:



The engine oil level is shown.

One of the following messages will appear on the driver's display:

- **Engine Oil Level Measuring Now....**: the engine oil level cannot be determined yet.
- ▶ Repeat the request after a maximum of 30 minutes' driving.
- **Engine Oil Level OK** and the bar display for indicating the engine oil level on the driver's display is green and is between "min" and "max": the engine oil level is correct.
- **Engine Oil Level Refill 1,0 liq.gal.** and the bar display for indicating the engine oil level on the driver's display is yellow and is below "min":
- ▶ Add 1.1 US qt (1 l) of engine oil.
- **Engine Oil Level Reduce** and the bar display for indicating the engine oil level on the driver's display is yellow and is above "max":

▶ Drain off any excess engine oil that has been added. To do so, consult a qualified specialist workshop.

- **For Engine Oil Level Switch on Vehicle**

▶ Switch on the vehicle to check the engine oil level.

- **Engine Oil Level System Inoperative**: The oil level sensor is defective or not connected.

▶ Consult a qualified specialist workshop.

- **Engine Oil Level System Currently Unavailable**

▶ Close the hood.

Refilling engine oil

⚠ WARNING Risk of burns from hot component parts in the engine compartment

Certain component parts in the engine compartment can be very hot, e.g. the engine, the cooler and parts of the exhaust system.

▶ Allow the engine to cool down and only touch component parts described in the following.

⚠ WARNING Risk of fire and injury from engine oil

If engine oil comes into contact with hot component parts in the engine compartment, it may ignite.

- ▶ Make sure that no engine oil is spilled next to the filler opening.
- ▶ Allow the engine to cool off and thoroughly clean the engine oil from component parts before starting the vehicle.

! NOTE Engine damage caused by an incorrect oil filter, incorrect oil or additives

- ▶ Do not use engine oils or oil filters which do not correspond to the specifications explicitly prescribed for the service intervals.
- ▶ Follow the instructions on the service interval display for changing the engine

oil and observe the prescribed change intervals.

- ▶ Do not use additives.

! **NOTE** Damage caused by adding too much engine oil

Excessive engine oil can damage the engine or the catalytic converter.

- ▶ Have excess engine oil removed in a qualified specialist workshop.

- i** Depending on driving style, the vehicle consumes up to 0.9 US qt (0.8 liters) of oil per 600 miles (1,000 km). The oil consumption may also be higher than this when the vehicle is new or if you frequently drive at high engine speeds.
- i** Depending on the engine, the cap may be located in different positions in the engine compartment.

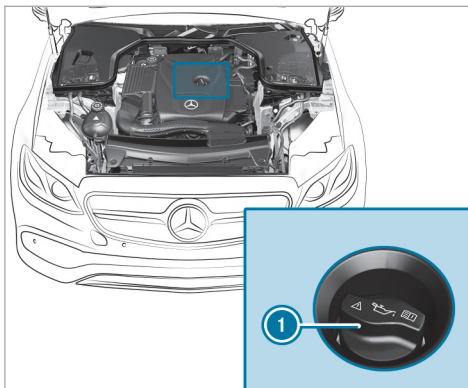

- ▶ Turn cap **1** counter-clockwise and remove it.
- ▶ Refill engine oil.
- ▶ Replace cap **1** and turn it clockwise until it engages.
- ▶ Check the oil level again (→ page 334).

Checking the coolant level

! **WARNING** Risk of burns from hot component parts in the engine compartment

Certain component parts in the engine compartment can be very hot, e.g. the engine, the cooler and parts of the exhaust system.

- ▶ Allow the engine to cool down and only touch component parts described in the following.

! **WARNING** Risk of scalding from hot coolant

If you open the cap, you could be scalded.

- ▶ Let the motor cool down before opening the cap.
- ▶ When opening the cap, wear protective gloves and safety glasses.
- ▶ Open the cap slowly to release pressure.

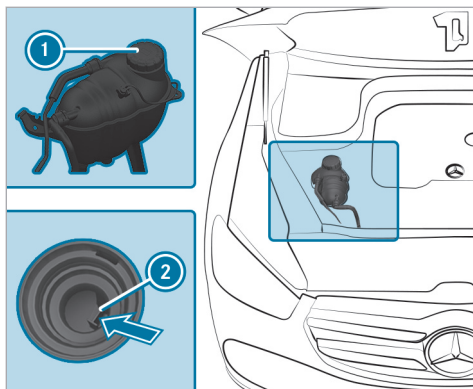

- ▶ Park the vehicle on a level surface.
- ▶ Check the coolant temperature display on the driver's display.
The coolant temperature must be in the bottom quarter of the temperature indicator.
- ▶ Slowly turn cap ① counter-clockwise to release overpressure.

- ▶ Continue turning cap ① counter-clockwise and remove it.

The coolant level is correct in the following cases:

- If the engine is cold, the coolant is up to marker bar ②.
 - If the engine is warm, the coolant is up to 0.6 in (1.5 cm) over the marker bar ②.
- ▶ If necessary, refill with coolant that has been approved for Mercedes-Benz.

① Further information on coolant (→ page 411).

Refilling the windshield washer system

- ⚠ **WARNING** Risk of burns from hot component parts in the engine compartment

Certain component parts in the engine compartment can be very hot, e.g. the engine, the cooler and parts of the exhaust system.

- ▶ Allow the engine to cool down and only touch component parts described in the following.

- ⚠ **WARNING** - Risk of fire and injury from windshield washer concentrate

Windshield washer concentrate is highly flammable. It could ignite if it comes into contact with hot engine component parts or the exhaust system.

- ▶ Make sure that no windshield washer concentrate spills out next to the filler opening.

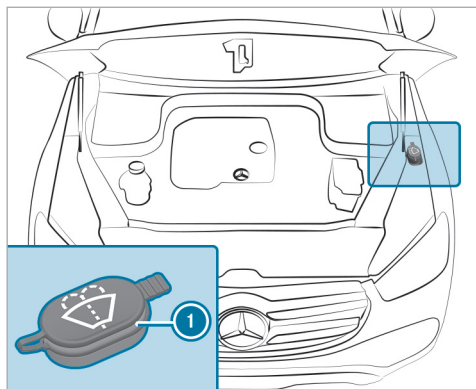

- ▶ Remove cap ❶ by the tab.
- ▶ Add washer fluid.
- ❶ Further information about the windshield washer fluid (→ page 412).

Keeping the air/water duct free

- ▶ Keep the area between the hood and the windshield free of deposits, e.g. ice, snow or leaves.

Cleaning and care

Information on washing the vehicle in a car wash

⚠ WARNING Risk of accident due to reduced braking effect after washing the vehicle

The braking effect is reduced after washing the vehicle.

- ▶ After the vehicle has been washed, brake carefully while paying attention to the traffic conditions until the braking effect has been fully restored.

! NOTE Damage from automatic braking

If one of the following functions is activated, the vehicle will brake automatically in certain situations:

- Active Brake Assist
- Active Distance Assist DISTRONIC
- HOLD function
- Active Parking Assist

To avoid damage to the vehicle, switch off these systems, e.g. when towing or using a car wash.

! NOTE Damage due to unsuitable car wash

- ▶ Before driving into a car wash make sure that the car wash is suitable for the vehicle dimensions.
- ▶ Ensure there is sufficient ground clearance between the underbody and the guide rails of the car wash.

▶ Ensure that the clearance width of the car wash, in particular the width of the guide rails, is sufficient.

To avoid damage to your vehicle when using a car wash, ensure the following beforehand:

- Active Distance Assist DISTRONIC is deactivated.
- The HOLD function is switched off.
- The 360° camera or the reversing camera is switched off.
- The side windows and sliding sunroof are completely closed.
- The exterior mirrors are folded in.
- The blower for the ventilation and heating is switched off.
- The windshield wiper switch is in position **0**.
- The key is at a minimum distance of 10 ft (3 m) away from the vehicle. Otherwise the tailgate could open unintentionally.
- For car washes with conveyor systems:
 - neutral **N** is engaged.
 - If you would like to leave the vehicle while it is being washed, make sure the key is located in the vehicle. The park position **P** is otherwise automatically engaged.

- ⓘ To prevent damage to the tires and rims, drive straight and in to the center of the guide rails of the car wash.
- ⓘ Removing the wax from the windshield and the wiper blades after washing the vehicle will help avoid smearing and reduce wiper noise.

Car wash mode

In car wash mode, the vehicle is configured in readiness for entering an automatic car wash. Car wash mode can be activated up to a speed of 12 mph (20 km/h) (→ page 340).

The following settings will be adjusted when car wash mode is activated:

- The outside mirrors will be folded in.
- To prevent the windshield washer system from starting up automatically, the rain sensor will be deactivated.
- Air-recirculation mode will be activated.
- Parking Assist PARKTRONIC will be deactivated.
- **Vehicles with 360° camera:** the front image will be activated after approximately eight seconds.
- **Vehicles with HANDS-FREE ACCESS:** kick detection will be deactivated.
- **Vehicles with AIRMATIC:** the vehicle will be raised to the maximum possible vehicle level (→ page 233).
If raising takes longer than 25 seconds, the following message will appear on the driver display:
Preparation for Automatic Car Wash Incomplete See Central Display. After some time, the vehicle will automatically continue rising.
- **Vehicles with E-ACTIVE BODY CONTROL:** the vehicle will be raised to the maximum possible vehicle level (→ page 241).
If raising takes longer than 25 seconds, the following message will appear on the driver display:

Preparation for Automatic Car Wash Incomplete See **Central Display**. After some time, the vehicle will automatically continue rising.

If one of the settings cannot be selected, this will be indicated by a  after the respective setting.

Car wash mode will automatically be deactivated above a speed of 12 mph (20 km/h).

The following settings will be reset when car wash mode is deactivated:

- The outside mirrors will be folded out.
- The rain sensor will be activated.
- Air-recirculation mode will be deactivated.
- Parking Assist PARKTRONIC will be reset to the previously selected setting.
- **Vehicles with 360° camera:** the front image will be deactivated at speeds above 11 mph (18 km/h).
- **Vehicles with AIRMATIC:** the vehicle will be lowered to the previously set vehicle level.

- **Vehicles with E-ACTIVE BODY CONTROL:** the vehicle will be lowered to the previously set vehicle level.

Switching car wash mode on/off

Requirements:

- The vehicle is stationary.
- The vehicle is switched on.

Multimedia system:



Activating car wash mode

- ▶ Select **Automatic Car Wash Mode**.
- ▶ Select **Activate**.

If one of the settings cannot be selected, this will be shown by a  next to the respective setting.

- ⓘ For an overview of the settings configured when you activate car wash mode (→ page 339).

Deactivating car wash mode

- ▶ Select **Switch Off**.
The settings of car wash mode will be reset.
- ⓘ Car wash mode will be automatically deactivated as soon as your speed exceeds 12 mph (20 km/h).

Information on using a power washer

 **WARNING** Risk of an accident when using power washers with round-spray nozzles

The water jet can cause externally invisible damage.

Components damaged in this way may unexpectedly fail.

- ▶ Do not use a power washer with round-spray nozzles.
- ▶ Have damaged tires or chassis parts replaced immediately.

To avoid damage to your vehicle, observe the following when using a power washer:

- The key is at a minimum distance of 10 ft (3 m) away from the vehicle. Otherwise the tailgate could open unintentionally.
- Maintain a distance of at least 11.8 in (30 cm) to the vehicle.
- **Vehicles with decorative films:** Parts of your vehicle are covered with a decorative film. Maintain a distance of at least 27.6 in (70 cm) between the film-covered parts of the vehicle and the nozzle of the power washer. Move the nozzle of the power washer around while cleaning. The water temperature of the power washer must not exceed 140°F (60°C).
- Observe the information on the correct distance in the equipment manufacturer's operating instructions.
- Do not point the nozzle of the power washer directly at sensitive parts, e.g. tires, gaps, electrical components, batteries, illuminants or ventilation louvers.

Washing the vehicle by hand

! **NOTE** Engine damage due to water ingress

- ▶ Take care not to point the water jet directly towards the air inlet grille below the hood.

Observe the relevant legal requirements (e.g. in some countries, washing by hand is permitted only in specially designated wash bays).

- ▶ Use a mild cleaning agent, e.g. car shampoo.
 - ▶ Do not use acidic cleaning agents.
 - ▶ Wash the vehicle with lukewarm water using a soft car sponge. When doing so, do not expose the vehicle to direct sunlight.
 - ▶ Carefully hose the vehicle off with water and dry using a chamois.
- i** Observe the notes on the care of vehicle parts (→ page 343).

Notes on paintwork/matte finish paintwork care

To avoid damaging the paintwork and interfering with the driving assistance systems, please observe the following notes:

Paint

- Insect remains: soak with insect remover and rinse off the treated areas afterwards.
- Bird droppings: soak with water and rinse off afterwards.
- Tree resin, oils, fuels and greases: remove by rubbing gently with a cloth soaked in petroleum ether or lighter fluid.
- Coolant and brake fluid: remove with a damp cloth and clean water.
- Tar stains: use tar remover.
- Wax: use silicone remover.
- Do not attach stickers, films or similar materials. Only have film attached to the bumper at a qualified specialist workshop.
- Remove dirt immediately, where possible. Do not use acidic solutions and acidic cleaning agents.

Matte finish

- Only use care products approved for Mercedes-Benz.
- Do not attach stickers, films or similar materials. Only have film attached to the bumper at a qualified specialist workshop.
- Do not polish the vehicle or the light-alloy wheels.
- Only use car washes that correspond to the latest engineering standards.
- Do not use a car wash program with a final hot wax treatment.
- Do not use paint cleaners, buffing or polishing products, gloss preservers, e.g. wax.

In the event of paintwork damage:

- Always have paintwork repairs carried out at a qualified specialist workshop.
- Make sure the radar sensors function (→ page 191).

Notes on cleaning decorative car films

Please observe the "Notes on paintwork / matt paintwork care" (→ page 341). These notes also apply for matt decorative car films.

To avoid damage, please observe the notes on cleaning decorative car films.

Cleaning

- When cleaning with a power washer, maintain a minimum distance of 27.6 in (70 cm) between the film-covered parts of the vehicle and the nozzle of the power washer.
- To clean, use lots of water and a mild cleaning agent without additional or abrasive products, e.g. a car shampoo approved for Mercedes-Benz.
- Do not use any acidic cleaning agents.
- Remove dirt immediately, if possible. Avoid hard rubbing to avoid damaging the decorative car film irreparably.
- In case of dirt embedded in the surface or a dull decorative car film: use the 'Paint Cleaner' cleaning agent recommended and approved for Mercedes-Benz.

- Insect remains: Soak with insect remover and rinse off the treated areas afterwards.
- Bird droppings: Soak with water and rinse off afterwards.
- Dry vehicles covered with car film after every wash using a soft, absorbent cloth to prevent water stains.

Preventing damage to the decorative car film

- The durability and color of decorative car films are affected by:
 - Solar radiation
 - Temperature, e.g. heat gun
 - Weather
 - Stone chips and dirt
 - Chemical cleaning products
 - Products containing grease
- Do not use polishes on matt decorative car films. Polishing results in the film-covered surface developing a shine.
- Do not use wax on matt or structured decorative car films. This may result in permanent stains.

Scratches, corrosive deposits, etched areas and damage caused by inadequate care cannot always be completely repaired. In such cases, please contact a qualified specialist workshop.

For more information about special care and cleaning products, please contact the manufacturer.

Laminated surfaces may exhibit optical differences to surfaces which were not protected by a decorative film when the decorative film is removed.

i Have work or repairs on decorative car film carried out at a qualified specialist workshop, e.g. a Mercedes-Benz Service Center.

Information on window films

! **NOTE** Damage to electronic components due to excess fluids

When window films have been retrofitted, fluids such as cleaning agents or water may run down and get behind trim parts of the vehicle

interior and cause damage to electronic components.

- ▶ Use cleaning agents as sparingly as possible.
- ▶ Immediately absorb any excess fluids.

Notes on car parts cleaning and care

! **WARNING** Risk of entrapment if the windshield wipers are switched on while the windshield is being cleaned

If the windshield wipers are set in motion while you are cleaning the windshield or wiper blades, you can be trapped by the wiper arm.

- ▶ Always switch off the windshield wipers and the vehicle before cleaning the windshield or wiper blades.

! **NOTE** Damage caused by acidic cleaning agents

- ▶ Do not use acidic cleaning agents. Otherwise, the surfaces could be damaged.

To avoid damage to the vehicle, observe the notes on cleaning and care of the following car parts:

Windows

! **NOTE** Damage to electronic components due to excess fluids

When cleaning the windows from the inside, fluids such as cleaning agents or water may run down and get behind trim parts of the vehicle interior and cause damage to electronic components.

- ▶ Use cleaning agents as sparingly as possible.
- ▶ Immediately absorb any excess fluids.

- Clean the windows inside and outside with a damp cloth and with a cleaning agent recommended for Mercedes-Benz.
- Do not use dry cloths or abrasive or solvent-based cleaning agents to clean the insides of windows.

- ⓘ After changing the wiper blades or treating the vehicle with wax, clean the windshield thoroughly with cleaning agents recommended for Mercedes-Benz. Failure to observe the application instructions may result in damage, smear marks or glare spots.
- ⓘ Remove external misting or dirt on the windshield in front of the multifunction camera. Otherwise, driving systems and driving safety systems may be impaired or unavailable (→ page 191).

Wheels and rims

- Use water and acid-free alloy wheel cleaners.
- Do not use acidic alloy wheel cleaners to remove brake dust. This could damage wheel bolts and brake components.
- To avoid corrosion of the brake discs and pads, drive the vehicle for a few minutes after cleaning before parking it. The brake discs and brake linings will warm up and dry out.

Wiper blades

- Move the wiper arms into the replacement position (→ page 140).

- With the wiper arms folded out, clean the wiper blades with a damp cloth.
- ⓘ Note that the wiper blades are coated. The coating may leave residue on a cloth. Do not rub the wiper blades excessively or clean them too often.

Exterior lighting

- Clean the lenses with a wet sponge and mild cleaning agent (e.g. car shampoo).
- Use only cleaning agents or cleaning cloths that are suitable for plastic lenses.

Sensors

- Clean the sensors in the front and rear part of the vehicle with car shampoo, plenty of water and a soft cloth (→ page 191).
- When using a power washer, maintain a minimum distance of 11.8 in (30 cm).

Running boards

- Use water and acid-free cleaning agents.
- Do not clean the aluminum trim inserts of the running board with alkaline or acidic cleaning agents such as wheel cleaners. Do not use

acidic alloy wheel cleaners to remove brake dust. The aluminum trim inserts could otherwise be damaged.

Cameras

- Open the camera cover with the multimedia system (→ page 251).
- Use clean water and a soft cloth to clean the camera lenses.
- Do not use a power washer.
- ⓘ Remove external misting or dirt on the windshield in front of the multifunction camera. Otherwise, driving systems and driving safety systems may be impaired or unavailable (→ page 191).

Trailer hitch

- Observe the notes on care in the trailer hitch manufacturer's Operator's Manual.
- Do not clean the ball neck with a power washer or solvent.
- Remove traces of rust on the ball (e.g. with a wire brush).
- Remove dirt with a lint-free cloth.

- After cleaning, lightly oil or grease the ball head.
- ① Before using trailers with anti-swerve coupling, note the manufacturer's Operator's Manual.

Notes on care of the interior

⚠ WARNING Risk of injury from plastic parts breaking off after the use of solvent-based care products

Care and cleaning products containing solvents can cause surfaces in the cockpit to become porous. When the airbags are deployed, plastic parts may break away.

- ▶ Do not use any care or cleaning products containing solvents to clean the cockpit.

⚠ WARNING Risk of injury or fatal injuries from bleached seat belts

Bleaching or dyeing seat belts can severely weaken them.

This can, for example, cause seat belts to tear or fail in an accident.

- ▶ Never bleach or dye seat belts.

! NOTE Property damage due to disinfectants

The interior includes a number of sensitive surfaces such as displays, plastics and leather.

Disinfectants can contain alcohol and other substances that penetrate and damage surfaces. Technology behind buttons and displays can also be damaged.

- ▶ Do not use disinfectant on interior surfaces.

To avoid damage to the vehicle, observe the following notes on cleaning and care:

Seat belts

- Clean with lukewarm and soapy water.
- Do not use chemical cleaning agents.

- Do not dry by heating them to over 176°F (80°C) or exposing them to direct sunlight.

Display

- Switch off the display and let it cool down.
- Clean the surface carefully with a microfiber cloth and a suitable display care product (TFT-LCD).
- Do not use any other agents.

Head-up display

- Clean with a soft, non-static, lint-free cloth.
- Do not use cleaning agents.

Plastic trim

- Clean with a damp microfiber cloth.
- For heavy soiling: Use a cleaning agent recommended for Mercedes-Benz.
- Do not attach stickers, films or similar materials.
- Do not allow cosmetics, insect repellent or sun cream to come in contact with the plastic trim.

Real wood and trim elements

- Clean with a microfiber cloth.
- Black piano-lacquer look: clean with a damp cloth and soapy water.
- For heavy soiling: Use a cleaning agent recommended for Mercedes-Benz.
- Do not use solvent-based cleaning agents, polishes or waxes.

Headliner

- Clean with a brush or dry shampoo.

Carpet

- Use a carpet and textile cleaning agent recommended for Mercedes-Benz.

Imitation leather steering wheel

- Clean the entire steering wheel with a damp cotton cloth and a 1% soap solution. Do not spot clean.
- Use cleaning and care products recommended for Mercedes-Benz.
- Do not use a microfiber cloth.
- Do not use oil-based cleaning and care products.

Steering wheel made of genuine leather or DINA-MICA**! NOTE** Damage caused by wrong cleaners

▶ Do not use solvent-based cleaning agents such as tar remover or wheel cleaner; neither should you use polishes or waxes. Otherwise you may damage the finish.

- Clean with a damp cloth and a 1% soap solution and then wipe with a dry cloth.
- For heavy soiling: Use a cleaning agent recommended for Mercedes-Benz.
- Leather care: Use a leather care agent that has been recommended for Mercedes-Benz.
- Do not allow the leather to become too damp.
- Do not use a microfiber cloth.

i Leather is a natural product. It has natural surface characteristics, such as differences in structure, marks caused by growth and injury or subtle color differences. These surface characteristics are particular to leather, and

are not material defects. Leather is also subject to a natural aging process, which changes the surface characteristics.

Genuine leather seat covers

- Vacuum up dirt such as crumbs or dust and then clean the seat covers with a damp cotton cloth and wipe down with a dry cloth. Regularly clean the seat covers.
- For heavy soiling: use a leather care agent recommended for Mercedes-Benz aftercare.
- Leather care: Use a leather care agent that has been recommended for Mercedes-Benz.
- Do not use a microfiber cloth.
- Do not allow the leather to become too damp.
- Do not use oil-based cleaning and care products.

i Leather is a natural product. It has natural surface characteristics, such as differences in structure, marks caused by growth and injury or subtle color differences. These surface characteristics are particular to leather, and are not material defects. Leather is also subject to a natural aging process, which changes the surface characteristics. Waves or wrinkling in the seat cover may occur due to the stress on the seat; this is caused by the natural leather material. Regular cleaning and care of the leather reduces soiling, wear marks and aging damage and thus significantly extends its life span. Clothing that can leave stains (e.g. jeans) may discolour the leather.

DINAMICA seat covers

- Vacuum up dirt such as crumbs or dust and then use a damp cloth to clean.
- Do not use a microfiber cloth.

Imitation leather seat covers

- Vacuum up dirt such as crumbs or dust and then use a damp cotton cloth and a 1% soap

solution to clean the entire seat cover. Do not spot clean.

- Use cleaning and care products recommended for Mercedes-Benz.
- Do not use a microfiber cloth.
- Do not use oil-based cleaning and care products.

Cloth seat covers

- Vacuum up dirt such as crumbs or dust and then use a damp microfiber cloth and a 1% soap solution to clean the entire seat cover. Do not spot clean.
- Use cleaning and care products recommended for Mercedes-Benz.
- Do not use oil-based cleaning and care products.

Emergency

Removing the safety vest

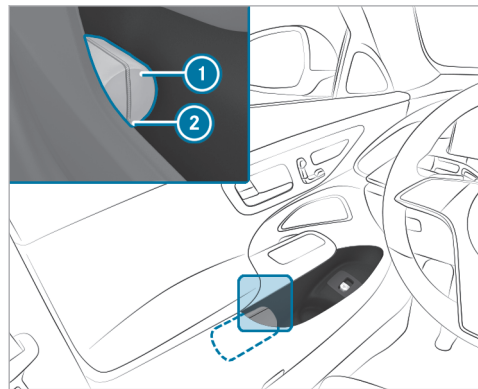

There is a safety vest stowage recess in the door stowage compartments of all doors for storing the safety vests.

- ▶ To remove: pull out the safety vest bag ① using the loop ②.

- ▶ Open the safety vest bag ① and take out the safety vest.
- ▶ To replace: fold the safety vest, roll it up and insert it into the safety vest bag ①.
- ▶ Slide the safety vest bag ① along the underside of the armrest into the safety vest stowage recess. Ensure that the loop ② remains hanging out so that it is easy to grasp.

- ① Remove the packaging film from a new safety vest before sliding it into the safety vest stowage recess. Otherwise, it may slide out unintentionally or the packaging may hinder its removal. Observe the legal requirements for the individual countries.

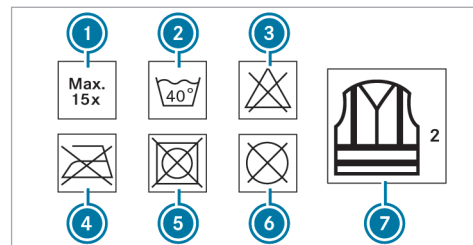

- ① Maximum number of washes
- ② Maximum wash temperature
- ③ Do not bleach
- ④ Do not iron
- ⑤ Do not tumble dry
- ⑥ Do not dry clean
- ⑦ Class 2 safety vest

The requirements defined by the legal standard are only fulfilled if the safety vest is the correct size and is fully closed.

Exchange the safety vest in the following cases:

- The reflective strips are damaged or dirty.

- The maximum permissible number of washes is exceeded.
- The fluorescence property decreases, e.g. due to permanent exposure to sunlight.

Dispose of the safety vest in an environmentally friendly way:

- Please contact your local waste disposal company.

Warning triangle

Removing the warning triangle (not plug-in hybrid)

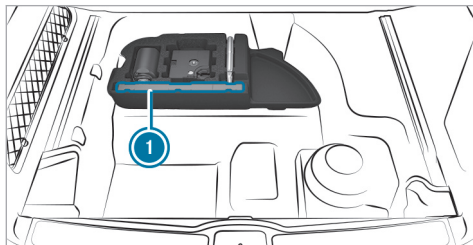

▶ Remove warning triangle ①.

Setting up the warning triangle

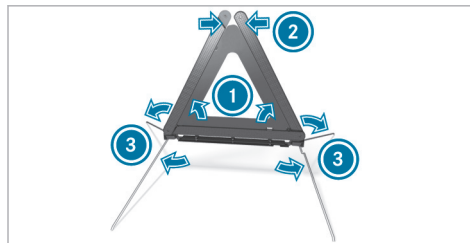

▶ Fold the side reflectors ① upwards to form a triangle and attach using the upper snap fastener ②.

▶ Fold the legs ③ down and out to the side.

First-aid kit (soft sided) overview

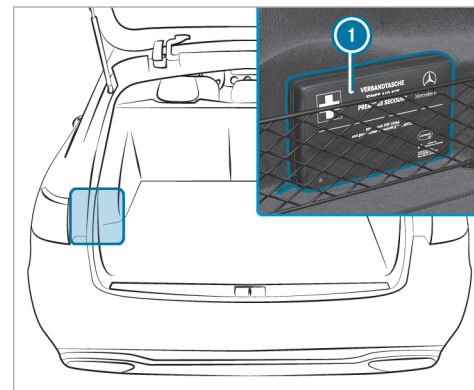

Depending on the vehicle equipment, the first-aid kit (soft sided) may be located in the following places in the vehicle:

- The first-aid kit (soft sided) ① is in the storage net on the left or right side of the cargo compartment.

Flat tire

Notes on flat tires

⚠ WARNING Risk of accident due to a flat tire

A flat tire severely affects the driving characteristics as well as steering and braking.

Tires without run-flat characteristics:

- ▶ Do not drive on with a flat tire.
- ▶ Change the flat tire immediately with an emergency spare wheel or spare wheel. Alternatively, consult a qualified specialist workshop.

Tires with run-flat characteristics:

- ▶ Observe the information and warning notes on MOExtended tires (run-flat tires).

In the event of a flat tire, you have the following options depending on your vehicle's equipment:

- **Vehicles with a TIREFIT kit:** you can seal the tire so that it is possible to continue your jour-

ney for a short period of time. To do this, use the TIREFIT kit (→ page 351).

- **Vehicles with Mercedes me connect:** you can make a call for breakdown assistance via the overhead control panel in the case of a breakdown (→ page 312).
 - **All vehicles:** change the wheel (→ page 393).
- i** The emergency spare wheel is available only in certain countries (→ page 398). Vehicles equipped with MOExtended tires are not equipped with a TIREFIT kit at the factory. It is therefore recommended that you additionally equip your vehicle with a TIREFIT kit if you mount tires on your vehicle that do not feature run-flat characteristics, e.g. winter tires. A TIREFIT kit may be obtained from a qualified specialist workshop.

Vehicles with a Mercedes-Benz emergency call system that are not equipped with a TIREFIT kit: in the event of a flat tire, contact the Customer Assistance Center for the Mercedes-Benz emergency call system .

Storage location of the TIREFIT kit (not plug-in hybrid)

The TIREFIT kit is located under the cargo floor.

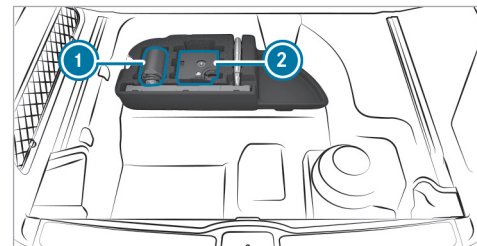

- ① Tire sealant bottle
- ② Tire inflation compressor

Depending on the vehicle version, the TIREFIT kit may also be located in other places under the cargo floor.

Using the TIREFIT kit

Requirements

- Tire sealant bottle and tire inflation compressor are ready for use (→ page 350).
- TIREFIT sticker is displayed.
- Gloves are present.

You can use TIREFIT tire sealant to seal perforation damage of up to 0.16 in (4 mm), particularly in the tire tread. You can use TIREFIT in outside temperatures down to -4°F (-20°C).

⚠ WARNING Risk of accident when using tire sealant

The tire sealant may be unable to seal the tire properly, especially in the following cases:

- There are large cuts or punctures in the tire (larger than damage previously mentioned)
- The wheel rims have been damaged
- After journeys with very low tire pressure or with flat tires

- ▶ Do not continue driving.
- ▶ Consult a qualified specialist workshop.

⚠ WARNING Risk of injury and poisoning from tire sealant

The tire sealant is harmful and causes irritation. Do not allow it to come into contact with the skin, eyes or clothing, and do not swallow it. Do not inhale tire sealant fumes. Keep the tire sealant away from children.

If you come into contact with the tire sealant, observe the following:

- ▶ Rinse off the tire sealant from your skin immediately using water.
- ▶ If tire sealant gets into your eyes, thoroughly rinse out the eyes using clean water.
- ▶ If tire sealant has been swallowed, immediately rinse out the mouth thoroughly and drink plenty of water. Do not induce vomiting and seek medical attention immediately.

- ▶ Change out of any clothes contaminated with tire sealant immediately.
- ▶ If allergic reactions occur, seek medical attention immediately.

! NOTE Overheating due to the tire inflation compressor running too long

- ▶ Do not run the tire inflation compressor for longer than ten minutes without interruption.

Observe the manufacturer's safety notes on the sticker on the tire inflation compressor.

Have the tire sealant bottle replaced at a qualified specialist workshop every five years.

- ▶ Do not remove any foreign objects that have pierced the tire.

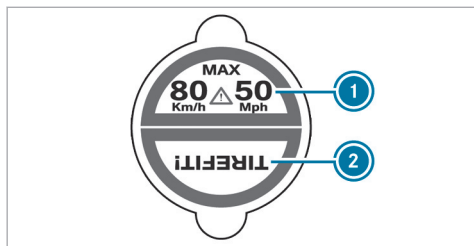

- ▶ Affix part ① of the TIREFIT sticker to the instrument cluster within the driver's field of vision.
- ▶ Affix part ② of the TIREFIT sticker near the valve on the wheel with the defective tire.

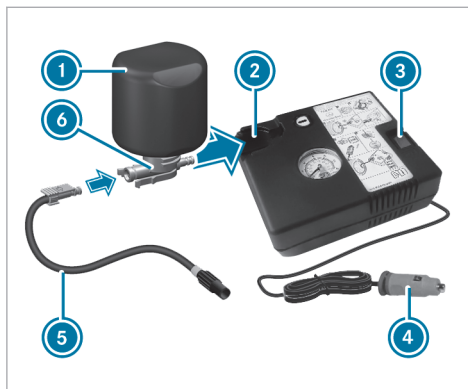

- ▶ Pull plug ④ with the cable and hose ⑤ out of the tire inflation compressor housing.
- ▶ Push the plug of hose ⑤ into flange ⑥ of tire sealant bottle ① until the plug engages.
- ▶ Place tire sealant bottle ① head downwards into recess ② of the tire inflation compressor.

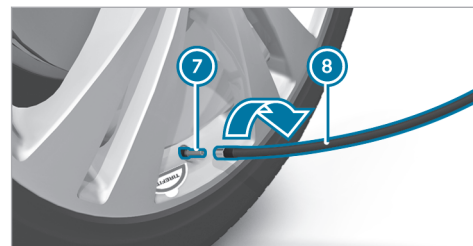

- ▶ Remove the valve cap from valve ⑦ on the defective tire.
 - ▶ Screw filling hose ⑧ onto valve ⑦.
 - ▶ Insert plug ④ into a 12 V socket in your vehicle.
 - ▶ Switch on the vehicle.
 - ▶ Switch on the tire inflation compressor using On/Off switch ③.
- The tire will be inflated. First, tire sealant will be pumped into the tire. The pressure may briefly rise to approximately 500 kPa (5.0 bar/ 73 psi).

Do not switch off the tire inflation compressor during this phase!

- ▶ Allow the tire inflation compressor to run for a maximum of ten minutes.
The tire should then have attained a tire pressure of at least 200 kPa (2.0 bar/29 psi).

If tire sealant leaks out, make sure you clean the affected area as quickly as possible. It is preferable to use clean water.

If you get tire sealant on your clothing, have it cleaned as soon as possible with perchloroethylene.

If, after ten minutes, a tire pressure of 200 kPa (2.0 bar/29 psi) has not been attained:

- ▶ Switch off the tire inflation compressor.
- ▶ Unscrew the filling hose from the valve of the defective tire.

Please note that tire sealant may leak out when you unscrew the filling hose.

- ▶ Drive the vehicle forwards or in reverse very slowly for approximately 33 ft (10 m).

- ▶ Pump up the tire again.
After a maximum of ten minutes, the tire pressure must be at least 200 kPa (2.0 bar/29 psi).

⚠ WARNING Risk of accident due to the specified tire pressure not being achieved

If the specified tire pressure is not achieved after the specified time, the tire is too badly damaged. The tire sealant cannot repair the tire in this instance.

The braking characteristics as well as the driving characteristics may be greatly impaired.

- ▶ Do not continue driving.
- ▶ Consult a qualified specialist workshop.

If, after ten minutes, a tire pressure of 200 kPa (2.0 bar/29 psi) has been attained:

- ▶ Switch off the tire inflation compressor.
- ▶ Unscrew the filling hose from the valve of the defective tire.

⚠ WARNING Risk of accident from driving with sealed tires

A tire temporarily sealed with tire sealant impairs the handling characteristics and is not suitable for higher speeds.

- ▶ Adapt your driving style accordingly and drive carefully.
- ▶ Do not exceed the maximum speed limit with a tire that has been repaired using tire sealant.

- ▶ Observe the maximum permissible speed of 50 mph (80 km/h) for a tire sealed with tire sealant.

! NOTE Staining caused by leaking tire sealant

After use, excess tire sealant may leak out from the filling hose.

- ▶ Therefore, place the filling hose in the plastic bag that contained the TIREFIT kit.

ENVIRONMENTAL NOTE Environmental pollution caused by environmentally irresponsible disposal

Tire sealant contains pollutants.

- ▶ Have the tire sealant bottle disposed of professionally, e.g. at an authorized Mercedes-Benz Center.

- ▶ Stow the tire sealant bottle and the tire inflation compressor.
- ▶ Pull away immediately.
- ▶ Stop driving after approximately ten minutes and check the tire pressure using the tire inflation compressor.
The tire pressure must now be at least 130 kPa (1.3 bar/19 psi).

WARNING Risk of accident due to the specified tire pressure not being attained

If the specified tire pressure is not reached, the tire is too badly damaged. The tire sealant cannot repair the tire in this instance.

The braking and driving characteristics may be greatly impaired.

- ▶ Do not continue driving.
- ▶ Consult a qualified specialist workshop.

In cases such as the one mentioned above, contact an authorized Mercedes-Benz Center. Alternatively, call 1-800-FOR-MERCEDES (in the USA) or 1-800-387-0100 (in Canada).

- ▶ **To increase the tire pressure:** switch on the tire inflation compressor.

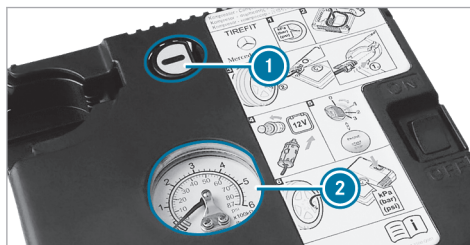

- ▶ **To reduce the tire pressure:** press pressure release button ① next to manometer ②.

- ▶ When the tire pressure is correct, unscrew the filling hose from the valve of the sealed tire.
- ▶ Screw the valve cap onto the valve of the sealed tire.
- ▶ Pull the tire sealant bottle out of the tire inflation compressor.
The filling hose should remain on the tire sealant bottle.
- ▶ Drive to the nearest qualified specialist workshop and have the tire, tire sealant bottle and filling hose replaced.

Battery (vehicle)

Notes on the 12-V-battery

WARNING Risk of an accident due to work carried out incorrectly on the battery

Work carried out incorrectly on the battery can, for example, lead to a short circuit. This can restrict functions relevant for safety systems and impair the operating safety of your vehicle.

You could lose control of the vehicle in the following situations in particular:

- When braking
 - In the event of abrupt steering maneuvers and/or when the vehicle's speed is not adapted to the road conditions
- ▶ In the event of a short circuit or a similar incident, contact a qualified specialist workshop immediately.
- ▶ Do not drive on.
- ▶ Always have work on the battery carried out at a qualified specialist workshop.

- Further information on ABS (→ page 193)
- Further information on ESP® (→ page 194)

For safety reasons, Mercedes-Benz recommends that you only use batteries which have been approved for your vehicle by Mercedes-Benz.

All vehicles except vehicles with a lithium-ion battery

⚠ WARNING Risk of explosion due to electrostatic charge

Electrostatic charge can ignite the highly explosive gas mixture in the battery.

- ▶ To discharge any electrostatic charge that may have built up, touch the metal vehicle body before handling the battery.

The highly flammable gas mixture is created while the battery is charging and during starting assistance.

⚠ WARNING Danger of chemical burns from the battery acid

Battery acid is caustic.

- ▶ Avoid contact with the skin, eyes or clothing.
- ▶ Do not lean over the battery.
- ▶ Do not inhale battery gases.

- ▶ Keep children away from the battery.
- ▶ Immediately rinse battery acid off thoroughly with plenty of clean water and seek medical attention immediately.

All vehicles

🔥 ENVIRONMENTAL NOTE Environmental damage due to improper disposal of batteries



Batteries contain pollutants. It is illegal to dispose of them with the household rubbish.



▶ Dispose of batteries in an environmentally responsible manner. Take discharged batteries to a qualified specialist workshop or to a collection point for used batteries.

If you have to disconnect the 12-V-battery, contact a qualified specialist workshop.

Comply with safety notes and take protective measures when handling batteries.



Risk of explosion if the 12-V-battery is used improperly.



Fire, open flame and smoking are prohibited when handling the battery. Avoid creating sparks.



Electrolyte or battery acid is corrosive. Avoid contact with the skin, eyes or clothing. Wear suitable protective clothing, in particular gloves, apron and face mask. Immediately rinse electrolyte or acid splashes off with clean water. Consult a doctor.



Do not place heavy objects on the surface of the battery or use the battery to support a person in any way.



Wear safety goggles.



Keep children away.



Observe this Operator's Manual.

If you do not intend to use the vehicle over an extended period of time, observe the following:

- **If available:** activate standby mode (→ page 190).
- Alternatively: connect the battery to a battery charger approved by Mercedes-Benz or consult a qualified specialist workshop to disconnect the battery.

Notes on the 48-V-battery



WARNING Risk of an accident due to work carried out incorrectly on the battery

Work carried out incorrectly on the battery can, for example, lead to a short circuit. This can restrict functions relevant for safety sys-

tems and impair the operating safety of your vehicle.

You could lose control of the vehicle in the following situations in particular:

- When braking
- In the event of abrupt steering maneuvers and/or when the vehicle's speed is not adapted to the road conditions
- ▶ In the event of a short circuit or a similar incident, contact a qualified specialist workshop immediately.
- ▶ Do not drive on.
- ▶ Always have work on the battery carried out at a qualified specialist workshop.

- Further information on ABS (→ page 193)
- Further information on ESP® (→ page 194)



ENVIRONMENTAL NOTE Environmental damage due to improper disposal of batteries



Batteries contain pollutants. It is illegal to dispose of them with the household trash.



Li-ion Dispose of batteries in an environmentally responsible manner. Take discharged batteries to a qualified specialist workshop or to a collection point for used batteries.

Only have work on the 48-V-battery carried out at a qualified specialist workshop.

Comply with safety notes and take protective measures when handling batteries.



Risk of explosion if the 48-V-battery is used improperly.



The surface of the 48-V-battery may be hot.



Fire, open flame and smoking are prohibited when handling the battery. Avoid creating sparks.



Electrolyte or battery acid is corrosive. Avoid contact with the skin, eyes or clothing. Wear suitable protective clothing, in particular gloves, apron and face mask. Immediately rinse off splashes of electrolyte or acid with plenty of clean water. Consult a doctor.



Do not place heavy objects on the surface of the battery or use the battery to support a person in any way.



Do not perform any work on the battery. Always have any work on the battery carried out at a qualified specialist workshop. Do not disconnect the battery yourself. Do not remove the battery yourself. Do not attempt to open the battery.



Keep children away.



Wear safety goggles.



Observe this Operator's Manual.

If you do not intend to use the vehicle over an extended period of time, observe the following:

- **If available:** activate standby mode (→ page 190).

Notes on starting assistance and charging the 12-V-battery

All vehicles

Always use the jump-start connection point in the engine compartment for charging the battery and jump starting.



NOTE Damage to the battery due to over-voltage

When charging using a battery charger without a maximum charging voltage, the battery or the on-board electronics may be damaged.



Only use battery chargers with a maximum charging voltage of 14.8 V.

⚠ WARNING Risk of explosion due to igniting hydrogen gas

If you cause a short circuit or sparks occur, the hydrogen gas may ignite when a battery is charging.

- ▶ Ensure that the positive terminal of a connected battery does not come into contact with vehicle parts.
- ▶ Never place metal objects or tools on a battery.
- ▶ When connecting and disconnecting the battery, always observe the sequence of battery terminals described.
- ▶ When jump starting, take care to connect only battery terminals of identical polarity.
- ▶ When jump starting, always observe the sequence described for connecting and disconnecting the jumper cables.
- ▶ Do not connect or disconnect the battery terminals when the engine is running.

⚠ WARNING Risk of explosion due to a mixture of explosive gases

A mixture of explosive gases can escape from the battery during charging and jump starting.

- ▶ Fire, open flames, smoking and creating sparks must be avoided.
- ▶ Make sure that there is sufficient ventilation.
- ▶ Do not stand over the battery.

⚠ WARNING Risk of explosion from a frozen battery

A discharged battery may freeze at temperatures slightly above or below freezing point. During starting assistance or battery charging, battery gas can be released.

- ▶ Always allow a battery to thaw before charging it or performing starting assistance.

If the indicator/warning lamps in the instrument cluster do not light up at low temperatures, it is

very likely that the discharged battery has frozen. In this case you must neither charge the battery nor give the vehicle starting assistance.

The service life of a defrosted battery may be drastically shortened. The starting behaviour may deteriorate, in particular at low temperatures.

Having a defrosted battery checked at a qualified specialist workshop is recommended.

All vehicles**! NOTE** Damage caused by numerous or extended attempts to start the engine

Numerous or extended attempts to start the engine may damage the catalytic converter due to non-combusted fuel.

- ▶ Avoid numerous and extended attempts to start the engine.

Observe the following points during starting assistance and when charging the battery:

- Only use undamaged jumper cables/charging cables with a sufficient cross-section and insulated terminal clamps.

- Uninsulated parts of the terminal clamps must not come into contact with other metal parts while the jumper cables/charging cables are connected to the battery/jump-start connection point.
- The jumper cables/charging cables must not touch any parts which may move when the engine is running.
- Make sure that neither you nor the battery are electrostatically charged.
- Avoid fire and naked lights.
- Do not bend over a battery.

When charging the battery also observe the following points:

- Only use chargers tested and approved for Mercedes-Benz.
- Read the charger's Owner's Manual before you charge the battery.

Also observe the following points during starting assistance:

- Starting assistance may only be provided using vehicles, batteries or other jump start devices with a nominal voltage of 12-V-.
- The vehicles must not touch each other.
- **Vehicles with a gasoline engine:** jump-start the vehicle only when the engine and exhaust system are cold.

Starting assistance and charging the 12-V-battery

Prepare starting assistance/charging process

- ▶ Use the electric parking brake to secure the vehicle.
- ▶ Shift the transmission to position **P**.
- ▶ Switch off the vehicle and all electrical consumers.
- ▶ Open the engine hood.

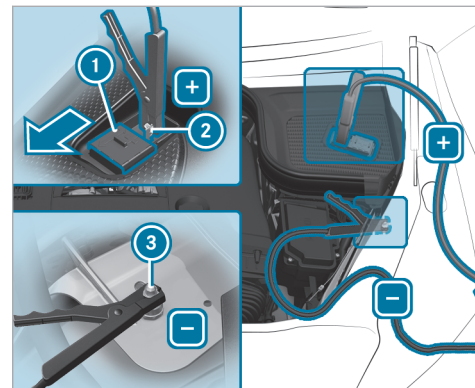

- ▶ Slide protective cover **1** of positive contact **2** on jump-start connection point in the direction of the arrow.

Starting assistance

- ▶ Connect the positive contact of your own vehicle to the jumper cable.
- ▶ Connect the positive terminal of the donor battery to the jumper cable.

- ▶ On the assisting vehicle, let the engine run at idling speed.
- ▶ Connect the negative terminal of the donor battery to the jumper cable.
- ▶ Connect the jumper cable to your vehicle's ground point ③.
- ▶ Start the engine of your own vehicle.
- ▶ Let the engines run for several minutes.
- ▶ Before disconnecting the jumper cable, switch on an electrical consumer in your own vehicle, e.g. the rear window heater or the lighting.

When starting assistance has finished:

- ▶ Disconnect the jumper cable from your vehicle's ground point ③.
- ▶ Release the jumper cable from the negative terminal of the donor battery.
- ▶ Release the jumper cable from the positive contact of your vehicle.
- ▶ Release the jumper cable from the positive terminal of the donor battery.

- ▶ Close the protective cover ① over the positive contact ②.

Further information can be obtained at a qualified specialist workshop.

Charging the 12 V battery

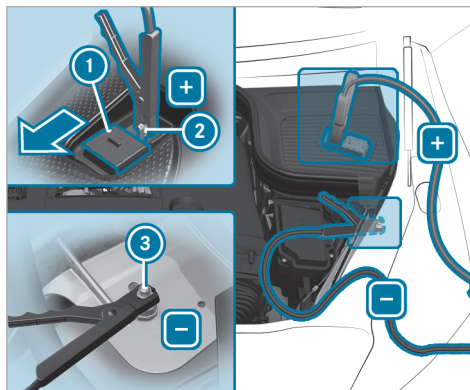

- ▶ Connect the positive contact ② of your own vehicle to the charging cable.

- ▶ Connect the positive terminal of the charger to the charging cable.
- ▶ Connect the negative terminal of the charger to the charging cable.
- ▶ Connect the charging cable to your vehicle's ground point ③.
- ▶ Start the charging process.

When the charging process is complete:

- ▶ Disconnect the charging cable from your vehicle's ground point ③.
- ▶ Release the charging cable from the negative terminal of the charger.
- ▶ Release the charging cable from the positive contact of your own vehicle.
- ▶ Release the charging cable from the positive terminal of the charger.
- ▶ Close the protective cover ① over the positive contact ②.

Replacing the 12 V battery

- ▶ Observe the notes on the 12 V battery (→ page 354).

Mercedes-Benz recommends that you have the 12 V battery replaced at a qualified specialist workshop, e.g. at a Mercedes-Benz Service Center.

If you want to replace the battery yourself, observe the following notes:

- Replace a faulty battery with a battery which meets the specific vehicle requirements.

The vehicle is equipped with a battery with AGM -technology (Absorbent Glass Mat) or a lithium-ion battery. Full vehicle functionality is only guaranteed with an AGM battery or lithium-ion battery. For safety reasons, Mercedes-Benz recommends that you only use batteries which have been tested and approved for your vehicle by Mercedes-Benz.

- Use the detachable parts such as vent hoses, elbow fittings or terminal covers from the battery which is to be replaced.

- Make sure that the vent hose is always connected to the original opening on the side of the battery.

Install any existing or supplied cell caps.

Otherwise, gases or battery acid could escape.

- Make sure that detachable parts are reconnected in the same way.

Tow starting or towing away

Overview of the permitted towing methods (not plug-in hybrid)

! NOTE Damage from automatic braking

If one of the following functions is activated, the vehicle will brake automatically in certain situations:

- Active Brake Assist
- Active Distance Assist DISTRONIC

- HOLD function
- Active Parking Assist

To avoid damage to the vehicle, switch off these systems, e.g. when towing or using a car wash.



Mercedes-Benz recommends transporting your vehicle in the case of a breakdown, rather than towing it away.

For towing with both axles on the ground, use a tow rope or tow rod. Do not use tow bar systems.

! NOTE Damage to the vehicle due to towing away incorrectly

- ▶ Observe the instructions and notes on towing away.

Permitted towing methods

Vehicle equipment/towing method	 Both axles on the ground	 Front axle raised	 Rear axle raised
4MATIC vehicles	Yes, for a maximum of 31 miles (50 km) at 31 mph (50 km/h)	No	No
Vehicles with rear-wheel drive	Yes, for a maximum of 31 miles (50 km) at 31 mph (50 km/h)	No	Yes, if the steering wheel is fixed in the center position with a steering wheel lock

Towing with a raised axle: towing should be performed by a towing company.

Towing away the vehicle with both axles on the ground

- ▶ Observe the notes on the permitted towing methods (→ page 361).
- ▶ Make sure that the battery is connected and charged.

A discharged battery has the following effects:

- The vehicle cannot be switched on
 - The electric parking brake cannot be released or applied
 - The transmission cannot be shifted to position **N** or **P**
- i** If the transmission cannot be shifted to position **N**, or the multifunction display in the instrument cluster does not show anything,

the vehicle must be transported away (→ page 364). A tow truck with lifting equipment is required for vehicle transport.

! **NOTE** Damage due to towing away at excessively high speeds or over long distances

The drivetrain could be damaged when towing at excessively high speeds or over long distances.

- ▶ A towing speed of 30 mph (50 km/h) must not be exceeded.
- ▶ A towing distance of 30 miles (50 km) must not be exceeded.

⚠ WARNING Risk of accident when towing a vehicle which is too heavy

If the vehicle to be tow-started or towed away is heavier than the permissible gross mass of your vehicle, the following situations can occur:

- The towing eye may become detached.
 - The vehicle/trailer combination may swerve or rollover.
- ▶ Before tow-starting or towing away, check if the vehicle to be tow-started or towed away exceeds the permissible gross mass.

- ▶ Information on the permissible gross mass of the vehicle can be found on the vehicle identification plate (→ page 405).

- ▶ Do not open the driver's door or front passenger door as the transmission may otherwise shift to position **P** automatically.
- ▶ Install the towing eye (→ page 365).
- ▶ Fasten the towing device.

! NOTE Damage due to incorrect connection of the tow bar

- ▶ Only connect the tow rope or tow bar to the towing eyes.

- ① You can also attach the towing device to the trailer hitch.
- ▶ Deactivate the automatic locking mechanism (→ page 79).
- ▶ Do not activate the HOLD function.
- ▶ Deactivate the tow-away alarm (→ page 96).
- ▶ Deactivate Active Brake Assist (→ page 222).
- ▶ Shift the transmission to position **N** (→ page 175).
- ▶ Release the electric parking brake.

⚠ WARNING Risk of accidents due to restricted safety-related functions during towing

Safety-relevant functions will be restricted or no longer available in the following situations:

- The vehicle is switched off.
- The brake system or the power steering is malfunctioning.
- The power supply or the on-board electrical system is defective.

If your vehicle is being towed, considerably more force may be required for steering and braking.

In addition, important vehicle display messages will not be visible if the driver display is faulty.

- ▶ Use a tow bar.
- ▶ Before towing, ensure that the driver's display is operational and the steering can move freely.

! **NOTE** Damage due to excessive tractive power

If you pull away sharply, the tractive power may be too high and the vehicles could be damaged.

- ▶ Pull away slowly and smoothly.

Loading up the vehicle for transport

- ▶ Observe the notes on towing (→ page 362).
- ▶ Connect the towing device to the towing eye in order to load up the vehicle.
- ⓘ You can also attach the towing device to the trailer hitch.
- ▶ Shift the automatic transmission to position **N**.
- ⓘ The automatic transmission may be locked in position **P** in the event of damage to the electrics. To shift to **N**, provide the on-board electrical system with power (→ page 359).
- ▶ Load the vehicle correctly onto the transporter.

- Ensure that all wheels are on the transportation surface.
- Ensure that the vehicle is parallel to the direction of travel.
- ▶ Put the selector lever into position **P**.
- ▶ Use the electric parking brake to secure the vehicle against rolling away.
- ▶ Stop the vehicle and switch off the power supply.
- ▶ Only secure the vehicle by the wheels.

Vehicles with ADS PLUS (Adaptive Damping System PLUS)

! **WARNING** Risk of an accident when transporting vehicles with Adaptive Damping System PLUS

When transporting vehicles with Adaptive Damping System PLUS, the vehicle/trailer combination may begin to rock and start to skid.

- ▶ Load the vehicle correctly onto the transporter.

- ▶ Secure the vehicle on all four wheels with suitable tensioning straps.
- ▶ Do not exceed the maximum permissible speed of 35 mph (60 km/h) when transporting.

! **NOTE** Damage to the vehicle from securing it incorrectly

- ▶ Secure the vehicle at all four wheels after loading. Otherwise, the vehicle could be damaged.
- ▶ Keep a minimum distance of 8 in (20 cm) above and 4 in (10 cm) below the transport platform.

- ▶ Load the vehicle correctly onto the transporter.
 - Ensure that all wheels are on the transportation surface.
 - Ensure that the vehicle is parallel to the direction of travel.
- ▶ Put the selector lever into position **P**.

- ▶ Use the electric parking brake to secure the vehicle against rolling away.
- ▶ Stop the vehicle and switch off the power supply.
- ▶ Secure the vehicle at all four wheels.

4MATIC vehicles/vehicles with automatic transmission

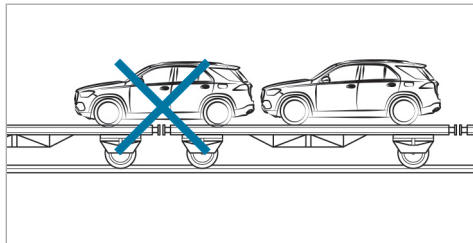

- ▶ Make sure that the front and rear axles come to rest on the same transport vehicle.

! **NOTE** Damage to the drive train due to incorrect positioning of the vehicle

- ▶ Do not position the vehicle above the connection point of the transport vehicle.

Towing eye storage location

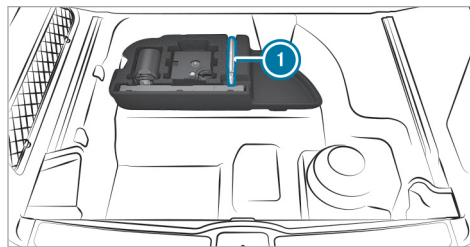

Towing eye ① is located under the cargo floor by the tire-change tool kit.

Installing and removing the towing eye

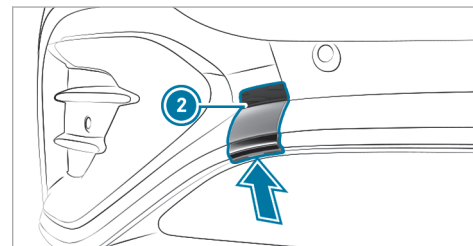

AMG Line

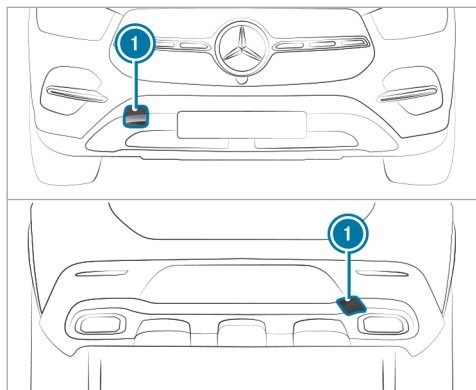

All other vehicles

- ▶ **AMG Line:** Press cover ① on the rear bumper inwards at the marking and remove. Lever off cover ② on the front bumper from below using a suitable implement, e.g. a screwdriver. Remove the cover from the opening without detaching.

- ▶ **All other vehicles:** press cover ① inwards at the marking and remove.
- ▶ Screw in the towing eye clockwise as far as it will go.

Vehicles with a trailer hitch: vehicles with a trailer hitch do not have a bracket at the back for the towing eye. Connect the tow bar to the trailer hitch.

- ▶ After removing the towing eye, engage cover ① in the bumper.

! **NOTE** Damage to the vehicle due to incorrect use of the towing eye or trailer hitch

When a towing eye or trailer hitch is used to recover a vehicle, the vehicle may be damaged in the process.

- ▶ Only use the towing eye or trailer hitch to tow away or tow start the vehicle.
- ▶ Do not use the towing eye or trailer hitch to tow the vehicle during recovery.

Tow-starting the vehicle

Vehicles with automatic transmission

- ▶ Observe the following note on material damage:

! **NOTE** Damage to the automatic transmission due to tow starting

The automatic transmission may be damaged in the process of tow starting vehicles with automatic transmission.

- ▶ Vehicles with automatic transmission must not be tow started.

Electrical fuses

Notes on electrical fuses

! **WARNING** Risk of accident and injury due to overloaded lines

If you manipulate or bridge a faulty fuse or if you replace it with a fuse with a higher amperage, the electric line could be overloaded.

This could result in a fire.

- ▶ Always replace faulty fuses with specified new fuses containing the correct amperage.

! NOTE Damage due to incorrect fuses

Using incorrect fuses can result in damage to electrical components or systems or their functions being considerably restricted.

- ▶ Use only fuses approved for Mercedes-Benz with the respective specified fuse rating.

Replace blown fuses with equivalent fuses, identifiable by their color and label. The fuse ratings and further information to be observed can be found in the fuse assignment diagram.

Fuse assignment diagram: on the fuse box in the load compartment (→ page 369).

! NOTE Damage or malfunctions caused by moisture

Moisture may cause damage to the electrical system or cause it to malfunction.

- ▶ When the fuse box is open, make sure that no moisture can enter the fuse box.
- ▶ When closing the fuse box, make sure that the seal of the lid is positioned correctly on the fuse box.

If the newly-inserted fuse also blows, have the cause determined and rectified at a qualified specialist workshop.

Ensure the following before replacing a fuse:

- The vehicle must be secured against rolling away.
- All electrical consumers must be switched off.
- The vehicle must be switched off.

The electrical fuses are located in various fuse boxes:

- Fuse box in the engine compartment on the left-hand side of the vehicle, when viewed in the direction of travel (→ page 367)
- Fuse box on the driver's side of the cockpit (→ page 368)
- Fuse box in the front passenger footwell (→ page 368)
- Fuse box in the load compartment on the right-hand side of the vehicle, when viewed in the direction of travel (→ page 369)

Opening and closing the fuse box in the engine compartment

Requirement:

- A dry cloth and a screwdriver are available.

Observe the notes on electrical fuses (→ page 366).

Opening

⚠ WARNING Risk of injury from using the windshield wipers when the hood is open

If the windshield wipers start moving when the hood is open, you could be trapped by the wiper linkage.

- ▶ Always switch off the windshield wipers and vehicle before opening the hood.

- ▶ Open the hood.

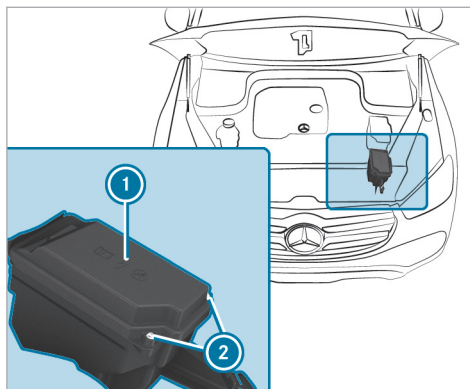

- ▶ Remove any existing moisture from the fuse box using a dry cloth.
- ▶ Loosen screws ② and remove fuse box lid ① from the top.

Closing

- ▶ Check whether the seal is positioned correctly in the lid.

- ▶ Insert the lid into the bracket at the rear of the fuse box.
- ▶ Fold down lid of the fuse box and tighten screws ②.
- ▶ Close the hood.

Opening and closing the fuse box in the cockpit

Requirements:

- Observe the notes on electrical fuses (→ page 366).

The fuse box is on the driver's side on the side of the cockpit under a cover.

- ▶ Contact a authorized Mercedes-Benz Center for further information.

Opening and closing the fuse box in the front passenger footwell

- ▶ Contact a Mercedes-Benz service center for further information.

Opening and closing the fuse box in the cargo compartment

Requirements

Observe the notes on electrical fuses
(→ page 366).

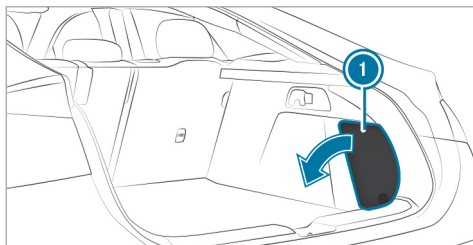

- ▶ **To open:** open cover ❶ in the direction of the arrow and remove it.
- ▶ **To close:** reinsert cover ❶.

The fuse assignment diagram is on the side of the fuse box.

Notes on noise or unusual handling characteristics

Make sure there are no vibrations, noises or unusual handling characteristics when the vehicle is in motion. This may indicate that the wheels or tires are damaged. Hidden tire damage could also be causing the unusual handling characteristics.

If you suspect that a tire is defective, reduce your speed immediately and have the tires and wheels checked at a qualified specialist workshop.

Notes on regularly inspecting wheels and tires

⚠ WARNING Risk of injury through damaged tires

Damaged tires can cause tire pressure loss.

- ▶ Check the tires regularly for signs of damage and replace any damaged tires immediately.

⚠ WARNING Risk of hydroplaning due to insufficient tire tread

Insufficient tire tread will result in reduced tire grip. There is a risk of an accident.

On a wet road surface the risk of hydroplaning is increased, in particular where speed is not adapted to suit the conditions.

- ▶ Check the tread depth and the condition of the tire contact surface across the entire width of all tires on a regular basis.

Minimum tread depth for

- summer tires: $\frac{1}{8}$ in (3 mm)
- M+S tires: $\frac{1}{6}$ in (4 mm)

- ▶ For safety reasons, replace the tires before the legally-prescribed limit for the minimum tread depth is reached.
- ▶ Replace the tires immediately if the legally-prescribed limit for the minimum tread depth is reached.

Carry out the following checks on all wheels regularly, at least once a month or as required, for example, prior to a long journey or driving off-road:

- Check the tire pressure (→ page 371).
- Visually inspect wheels and tires for damage.
- Check the valve caps.
- Visual check of the tire tread depth and the tire contact surface across the entire width.

The minimum tread depth for summer tires is $\frac{1}{8}$ in (3 mm) and for winter tires $\frac{1}{6}$ in (4 mm).

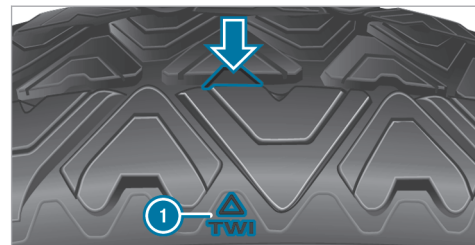

Six marks ① show where the bar indicators (arrow) are integrated into the tire tread. They are

visible once a tire tread depth of approximately $\frac{1}{16}$ in (1.6 mm) has been reached.

Notes on snow chains

⚠ WARNING Risk of accident due to incorrectly installed snow chains

If you have installed snow chains on the front wheels, they may drag against the vehicle body or chassis components.

- ▶ Never install snow chains on the front wheels.
- ▶ Only install snow chains on the rear wheels in pairs.

! NOTE Damage to components of the vehicle body or chassis due to mounted snow chains

If you mount snow chains to the front wheels of 4MATIC vehicles, you may damage components of the vehicle body or chassis.

- ▶ Only mount snow chains to the rear wheels of 4MATIC vehicles.

- Snow chains are only permissible for certain wheel/tire combinations. You can obtain information about this from a Mercedes-Benz service center.
 - For safety reasons, only use snow chains that have been specifically approved for your vehicle by Mercedes-Benz, or snow chains of the same quality standard.
 - Comply with the installation instructions of the snow chain manufacturer.
 - If snow chains are mounted, the maximum permissible speed is 30 mph (50 km/h).
 - **Vehicles with Active Parking Assist:** do not use Active Parking Assist when snow chains are mounted.
- i** You can deactivate ESP® to start off (→ page 195). This allows the wheels to spin, achieving increased tractive power.

Tire pressure

Notes on tire pressure

⚠ WARNING Risk of an accident owing to insufficient or excessive tire pressure

Tires with an insufficient or excessive pressure pose the following dangers:

- The tires can burst.
 - The tires can wear excessively and/or unevenly.
 - The driving characteristics as well as the steering- and braking may be greatly impaired.
- ▶ Observe the recommended tire pressure and check the tire pressure of all tires including the spare wheel:
- monthly
 - when the load changes
 - before embarking on a longer journey

- when the operating conditions change, e.g. off-road driving
- when driving at over 250 km/h
- ▶ Adjust the tire pressure if necessary.

Too high or too low tire pressure can:

- Shorten the service life of the tires.
- Lead to tire damage.
- Adversely affect driving characteristics and thus driving safety, e.g. due to aquaplaning.

▲ WARNING Risk of accident due to too low a tire pressure

Tires with pressure that is too low can overheat and burst as a consequence.

In addition, they also suffer from irregular wear, which can significantly impair the braking properties and the handling characteristics.

- ▶ Avoid excessively low tire pressure.

Too low tire pressure can cause:

- Tire defects as a result of overheating
- Impaired handling characteristics
- Irregular wear
- Increased fuel consumption

▲ WARNING Risk of accident due to too high a tire pressure

Tires with excessively high pressure can burst. In addition, they also suffer from irregular wear, which can significantly impair the braking properties and the handling characteristics.

- ▶ Avoid excessively high tire pressures.

Too high tire pressure can cause:

- Increased braking distance
- Impaired handling characteristics
- Irregular wear
- Impaired driving comfort
- Susceptibility to damage

▲ WARNING Risk of accident due to repeated pressure drop in the tires

The wheels, valves or tires could be damaged. Too low a tire pressure can lead to the tires bursting.

- ▶ Examine the tires for foreign objects.
- ▶ Check whether the tire has a puncture or the valve has a leak.
- ▶ If you are unable to rectify the damage, contact a qualified specialist workshop.

You can find information on tire pressure for the vehicle's factory-installed tires on the following labels:

- Tire and Loading Information placard on the B-pillar of your vehicle (→ page 377).
- Tire pressure table on the inside of the fuel filler flap (→ page 373).

Also observe the maximum tire pressure (→ page 384).

Use a suitable pressure gauge to check the tire pressure. The outer appearance of a tire does not give any reliable indication of the tire pressure.

Only correct the tire pressure when the tires are cold. Conditions for cold tires:

- The vehicle has been parked with the tires out of direct sunlight for at least three hours.
- The vehicle has travelled less than 1 mile (1.6 km).

The vehicle's tires heat up when driving. As the temperature of a tire increases, so does the tire pressure.

Vehicles with a tire pressure monitoring system: you can have the tire pressure shown in the driver display (→ page 375).

The tire pressure recommended for increased load/speed in the tire pressure table can affect the ride comfort.

⚠ WARNING Risk of accident due to unsuitable accessories on tire valves

If you mount unsuitable accessories onto tire valves, the tire valves may be overloaded and malfunction, which can cause tire pressure loss.

- ▶ Only screw standard valve caps or valve caps specifically approved by Mercedes-Benz for your vehicle onto the tire valve.

Notes on trailer operation

Only the tire pressure for increased loads recommended in the tire pressure table applies to the rear tires.

Tire pressure table

The tire pressure table is on the inside of the fuel filler flap.

- ⓘ The data shown in the images is example data.

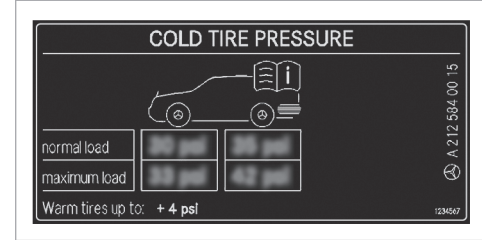

The tire pressure table shows the recommended tire pressure for all tires approved for this vehicle. The recommended tire pressures apply for cold tires under various operating conditions, i.e. vehicle load and/or speed.

If one or more tire sizes precede a tire pressure, the following tire pressure information is only valid for those tire sizes and their respective load condition.

The load conditions "partially laden" and "fully laden" are defined in the table for different numbers of passengers and amounts of luggage. The actual number of seats may differ from this.

		kPa	psi	kPa	psi
R18	[Tread icon]	[Grid]	[Grid]	[Grid]	[Grid]
R19	[Tread icon]	[Grid]	[Grid]	[Grid]	[Grid]
M+S	[Tread icon]	[Grid]	[Grid]	[Grid]	[Grid]

Some tire pressure tables only show the rim diameter instead of the complete tire size, e.g. **R18**. The rim diameter is part of the tire size. The rim diameter can be found on the sidewall of the tire (→ page 384).

- Tire and loading information plate (→ page 377)
- Maximum tire pressure (→ page 384)

Checking the tire pressure manually

- ▶ Read the tire pressure recommended for the current operating conditions from the tire and loading information placard or the tire pressure table. Observe the notes on tire pressure.
- ▶ Remove the valve cap of the tire to be checked.
- ▶ Press the tire pressure gauge securely onto the valve.
- ▶ Read the tire pressure.
- ▶ If the tire pressure is lower than the recommended value, increase the tire pressure to the recommended value.
- ▶ If the tire pressure is higher than the recommended value, release air. To do so, press down the metal pin in the valve, e.g. using the tip of a pen. Then check the tire pressure again using the tire pressure gauge.
- ▶ Screw the valve cap onto the valve.

Further related subjects:

- Notes on tire pressure (→ page 371)
- Tire pressure table (→ page 373)

- Tire and loading information placard (→ page 377)

Tire pressure monitoring system

Function of the tire pressure monitoring system

⚠ DANGER Risk of accident due to incorrect tire pressure

Each tire, including the spare (if provided), should be checked monthly when cold and inflated to the inflation pressure recommended by the vehicle manufacturer on the vehicle placard or tire inflation pressure label. (If your vehicle has tires of a different size than the size indicated on the vehicle placard or tire inflation pressure label, you should determine the proper tire inflation pressure for those tires.)

As an added safety feature, your vehicle has been equipped with a tire pressure monitoring system (TPMS) that illuminates a low tire pressure telltale when one or more of your tires is significantly under-inflated. Accordingly, when

the low tire pressure telltale illuminates, you should stop and check your tires as soon as possible, and inflate them to the proper pressure. Driving on a significantly under-inflated tire causes the tire to overheat and can lead to tire failure. Under-inflation also reduces fuel efficiency and tire tread life, and may affect the vehicle's handling and stopping ability. Please note that the TPMS is not a substitute for proper tire maintenance, and it is the driver's responsibility to maintain correct tire pressure, even if under-inflation has not reached the level to trigger illumination of the TPMS low tire pressure telltale.

Your vehicle has also been equipped with a TPMS malfunction indicator to indicate when the system is not operating properly. The TPMS malfunction indicator is combined with the low tire pressure telltale. When the system detects a malfunction, the telltale will flash for approximately one minute and then remain continuously illuminated. This sequence will continue upon subsequent vehicle start-ups as long as the malfunction exists.

When the malfunction indicator is illuminated, the system may not be able to detect or signal low tire pressure as intended. TPMS malfunctions may occur for a variety of reasons, including the installation of replacement or alternate tires or wheels on the vehicle that prevent the TPMS from functioning properly.

The system checks the tire pressure and the temperature of the tires installed on the vehicle by means of a tire pressure sensor.

The tire pressure and the tire temperature are displayed on the driver display.

In the event of significant pressure loss or excessive temperature of the tires, you will be warned by display messages (→ page 470) or the warning light  on the driver display (→ page 493).

The tire pressure monitoring system serves solely as an aid. It is the driver's responsibility to set the tire pressure to the recommended cold tire pressure suitable for the operating situation.

In most cases, the tire pressure monitoring system will automatically update the new reference

values after you have changed the tire pressure. You can, however, also update the reference values by restarting the tire pressure monitoring system manually (→ page 376).

System limits

The system may be impaired or inoperative in the following situations in particular:

- Incorrect reference values were taught in.
- Sudden pressure loss caused, e.g. by a foreign object penetrating the tire.
- There is a malfunction caused by another radio signal source.

■ Checking the tire pressure with the tire pressure monitoring system

Requirements:

- The vehicle is switched on.

Driver display:

  Service

 Press  to confirm.

One of the following messages will appear:

- Current tire pressure at each wheel:



- **Tire pressure displayed after driving for a few minutes.:** Current values are not yet known to the system. The pressure/temperature values for each tire will be displayed as soon as they are known to the system.
 - **Tire Pressure Monitor Active:** The teach-in process of the system is not yet complete. The tire pressures are already being monitored.
- ▶ Compare the current tire pressure with the recommended tire pressure for the current

operating status (→ page 373). Additionally, observe the notes on cold tires (→ page 371).

- ⓘ The values displayed on the driver display may deviate from those of the tire pressure gauge as they relate to sea level. At high elevations, the tire pressure values indicated by a pressure gauge will be higher than those shown on the driver display.

Bear in mind the following related topic:

- Notes on tire pressure (→ page 371)

Restarting the tire pressure monitoring system

Requirements

- The recommended tire pressure is correctly set for the respective operating condition at each of the four wheels (→ page 371).

Restart the tire pressure monitoring system in the following situations:

- The tire pressure has changed.
- The wheels or tires have been changed or newly installed.

Driver display:

→ ▶▶ Service

- ▶ Show tire pressure: press .
- ▶ Show options: press again.
- ▶ Select **Tire Pressure** and confirm with . The **Use current pressures as new reference values?** message will appear on the driver display.
- ▶ Select **Yes** and confirm the restart with . The **Tire Pressure Monitor Restarted** message will appear on the driver display.

Current warning messages will be deleted and the yellow warning lamp will go out.

After you have driven for a few minutes, the system will check whether the current tire pressures are within the specified range. The current tire pressures will then be accepted as reference values and monitored.

If the tire pressure levels are not within the specified range, the **Please Correct Tire Pressure** message will appear.

Bear in mind the following related topic:

- Notes on tire pressure (→ page 371)

Loading the vehicle

Notes on the Tire and Loading Information placard

⚠ WARNING Risk of accident from overloaded tires

Overloaded tires may overheat and burst as a consequence. Overloaded tires can also impair the steering and handling characteristics and lead to brake failure.

- ▶ Observe the load rating of the tires.
- ▶ The load rating must be at least half the permissible axle load of the vehicle.
- ▶ Never overload the tires by exceeding the maximum load.

The Tire and Loading Information placard is on the B-pillar on the driver's side of the vehicle.

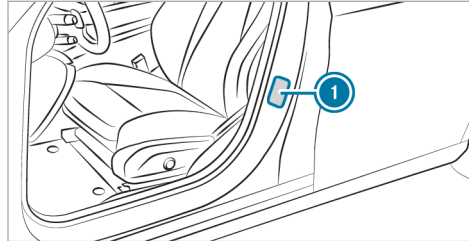

① Tire and Loading Information placard

TIRE AVANT RENSEIGNEMENTS		TOTAL		FRONT AVANT		MOLE EU		REAR ARRIÈRE	
SEATING CAPACITY NOMBRE DE PLACES	7	7	2	2	3	2			
The combin des occupants et du chargement ne doit jamais dépasser		weight of occupants and cargo should never exceed kg or xxx		kg ou xxx		lbs. ou xxx		lbs. ou xxx	
TIRE PNEU	SIZE DIMENSIONS	COLD TIRE PRESSURE PRESSION DES PNEUS À FROID		SEE OWNER'S MANUAL FOR ADDITIONAL INFORMATION					
FRONT AVANT	285/40 ZR18 90Y XL	200 KPA, 29 PSI		VOIR LE MANUEL DE L'USAGER POUR PLUS DE RENSEIGNEMENTS					
REAR ARRIÈRE	285/35 ZR18 101Y XL	200 KPA, 29 PSI							
SPARE DE SECOURS	175/55-18 95P	420 KPA, 60 PSI							

① The data shown in the illustration are sample data.

The Tire and Loading Information placard shows the following information:

- Maximum number of seats ② according to the maximum number of people permitted to travel in the vehicle.

378 Wheels and tires

- Maximum permissible load ③ comprises the gross weight of all vehicle occupants, luggage and additional load.
- Recommended tire pressure ① for cold tires. The recommended tire pressures are valid for the maximum permissible load and up to the maximum permissible vehicle speed.

Please also note:

- Information on permissible weights and loads on the vehicle identification plate (→ page 405).
- Information on the tire pressure in the tire pressure table (→ page 373).

Further related subjects:

- Determining the maximum permissible load (→ page 378).
- Notes on the tire pressure (→ page 371).

Steps for determining the correct load limit

The following steps were developed according to the regulations of Title 49, Code of U.S. Federal

Regulations, Part 575, which are binding on all manufacturers, and the National Traffic and Motor Vehicle Safety Act of 1966.

- ▶ (1): Locate the statement "The combined weight of occupants and cargo should never exceed XXX kg or XXX lbs." on your vehicle's placard.
- ▶ (2): Determine the combined weight of the driver and passengers that will be riding in your vehicle.
- ▶ (3): Subtract the combined weight of the driver and passengers from XXX kg or XXX lbs.
- ▶ (4): The resulting figure equals the available amount of cargo and luggage load capacity. For example, if the "XXX" amount equals 1400 lbs. and there will be five 150 lb passengers in your vehicle, the amount of available cargo and luggage load capacity is 650 lbs. (1400 - 750 (5 x 150) = 650 lbs.)
- ▶ (5): Determine the combined weight of luggage and cargo being loaded on the vehicle. That weight may not safely exceed the available cargo and luggage load capacity calculated in Step 4.

- ▶ (6): If your vehicle will be towing a trailer, load from your trailer will be transferred to your vehicle. Consult this manual to determine how this reduces the available cargo and luggage load capacity of your vehicle.

- ① Not all vehicles are permitted to tow a trailer. Towing a trailer is only permitted if a trailer-hitch is installed. Please consult an authorized Mercedes-Benz dealer if you have any questions about towing a trailer with your vehicle.

Even if you have calculated the total load carefully, you should still make sure that the maximum permissible gross weight and the maximum gross axle weight rating of your vehicle are not exceeded. Details can be found on the vehicle identification plate.

- ▶ Have your loaded vehicle – including driver, occupants and load – weighed on a vehicle weighbridge. The measured values may not exceed the maximum permissible values stated on the vehicle identification plate.

Further related subjects:

- Calculation example for determining the maximum load (→ page 379)
- Tire and loading information placard (→ page 377)
- Tire pressure table(→ page 373)
- Vehicle identification plate (→ page 405)

Calculation example for determining the maximum payload

The following table shows examples of how to calculate total load capacities and payloads with varying seating configurations and different occupant numbers and weights. The following examples use a maximum payload of 1500 lbs

(680 kg). **This is for illustration purposes only.** Make sure you are using the actual maximum payload for your vehicle as stated in the Tire and Loading Information table of your vehicle (→ page 377).

The higher the weight of all the occupants, the lower the maximum luggage load.

Step 1

	Example 1	Example 2
Combined maximum weight of occupants and payload (data from the Tire and Loading Information table)	1500 lbs (680 kg)	1500 lbs (680 kg)

Step 2

	Example 1	Example 2
Number of persons in the vehicle (driver and passengers)	5	1
Distribution of vehicle occupants	Front: 2 Rear: 3	Front: 1
Weight of vehicle occupants	Occupant 1: 150 lbs (68 kg) Occupant 2: 180 lbs (82 kg) Occupant 3: 160 lbs (73 kg) Occupant 4: 140 lbs (63 kg) Occupant 5: 120 lbs (54 kg)	Occupant 1: 200 lbs (91 kg)
Total weight of all vehicle occupants	750 lbs (340 kg)	200 lbs (91 kg)

Step 3

	Example 1	Example 2
Permissible payload (maximum permissible gross vehicle weight from the Tire and Loading Information table minus the total weight of all occupants)	1500 lbs (680 kg) - 750 lbs (340 kg) = 750 lbs (340 kg)	1500 lbs (680 kg) - 200 lbs (91 kg) = 1300 lbs (589 kg)

Tire labeling

Overview of tire labeling

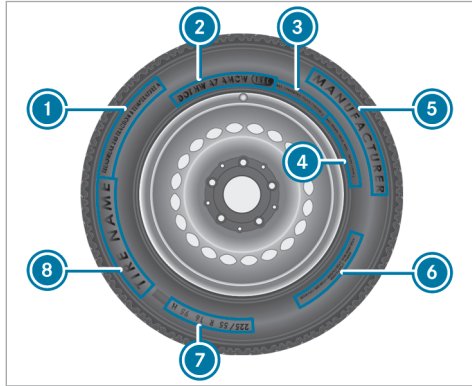

- ① Uniform Tire Quality Grading Standards
- ② DOT (Department of Transportation), (TIN) Tire Identification Number
- ③ Maximum tire load (→ page 383)
- ④ Maximum tire pressure (→ page 384)

- ⑤ Manufacturer
- ⑥ Tire characteristics (→ page 384)
- ⑦ Tire size designation, load-bearing capacity, speed rating and load index (→ page 384)
- ⑧ Tire name
- ⑨ The data shown in the illustration is example data.

Tire quality grading

In accordance with the US Department of Transportation's "Uniform Tire Quality Grading Standards," tire manufacturers are required to grade their tires on the basis of the following three performance factors:

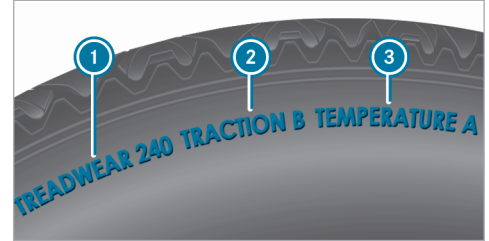

- ① Tread wear grade
- ② Traction grade
- ③ Temperature grade
- ④ The data shown in the illustration is example data.
- ⑤ The classification is not legally stipulated for Canada, but it is generally stated.

Tread wear grade

The treadwear grade is a comparative rating based on the wear rate of the tire when tested under controlled conditions on a specified government test course. For example, a tire graded 150 would wear one and one-half (1\1/2\) times as

well on the government course as a tire graded 100.

The relative performance of tires depends upon the actual conditions of their use, however, and may depart significantly from the norm due to variations in driving habits, service practices and differences in road characteristics and climate.

Traction grade

⚠ DANGER Risk of accident due to inadequate traction

The traction grade assigned to this tire is based on straight-ahead braking traction tests.

- ▶ Always adapt your driving style and drive at a speed to suit the prevailing traffic and weather conditions.

! NOTE Damage to the drivetrain from wheelspin

- ▶ Avoid wheelspin.

The traction grades, from highest to lowest, are AA, A, B, and C. Those grades represent the tire's ability to stop on wet pavement as measured under controlled conditions on specified government test surfaces of asphalt and concrete. A tire marked C may have poor traction performance.

Temperature grade

⚠ WARNING Risk of accident from tire overheating and tire failure

Excessive speed, underinflation, or excessive loading, either separately or in combination, can cause excessive heat build-up and possible tire failure.

- ▶ Observe the recommended tire pressure.
- ▶ Regularly check the pressure of all the tires.
- ▶ Adjust the tire pressure, if necessary.

The temperature grades are A (the highest), B, and C, representing the tire's resistance to the generation of heat and its ability to dissipate heat when tested under controlled conditions on a specified indoor laboratory test wheel. Sustained

high temperature can cause the material of the tire to degenerate and reduce tire life, and excessive temperature can lead to sudden tire failure. The grade C corresponds to a level of performance which all passenger car tires must meet under the Federal Motor Safety Standard No. 109. Grades B and A represent higher levels of performance on the laboratory test wheel than the minimum required by law.

DOT, Tire Identification Number (TIN)

US tire regulations stipulate that every tire manufacturer or retreader must imprint a TIN in or on the side wall of each tire produced.

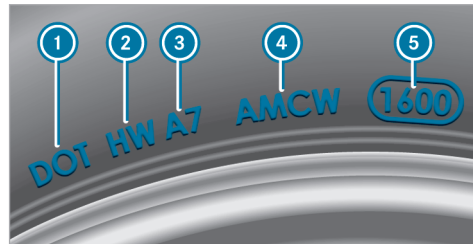

① The data in the illustration is shown as an example.

The TIN is a unique identification number to identify tires, and comprises the following:

- **DOT (Department of Transportation):** tire marking ① indicating that the tire complies with the requirements of the US Department of Transportation.
- **Manufacturer identification code:** the manufacturer identification code ② contains details of the tire manufacturer. New tires have a code with two symbols. Retreaded tires have a code with four symbols. Further information on retreaded tires (→ page 389).
- **Tire size:** the marking ③ states the tire size.
- **Tire type code:** the tire type code ④ can be used by the manufacturer as a code to describe specific characteristics of the tire.
- **Manufacturing date:** the manufacturing date ⑤ provides information about the age of a tire. The 1st and 2nd digits represent the calendar week and the 3rd and 4th digits state

the year of manufacture (e.g. "3208" represents the 32nd week of 2008).

Information on the maximum tire load

⚠ WARNING Risk of accident from overloaded tires

Overloaded tires may overheat and burst as a consequence. Overloaded tires can also impair the steering and handling characteristics and lead to brake failure.

- ▶ Observe the load rating of the tires.
- ▶ The load rating must be at least half the permissible axle load of the vehicle.
- ▶ Never overload the tires by exceeding the maximum load.



① The data in the illustration is shown as an example.

Maximum tire load ① is the maximum permissible weight for which the tire is approved.

Do not overload the tires by exceeding the maximum permissible load limit. The maximum permissible load can be found on the vehicle's Tire and Loading Information table on the B-pillar on the driver's side (→ page 377).

Information on maximum tire pressure

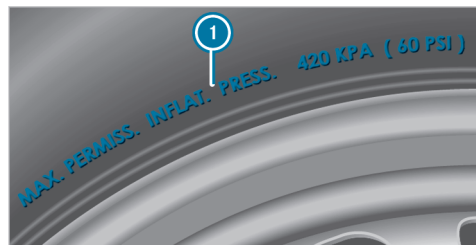

i The data in the illustration is shown as an example.

Do not exceed the maximum tire pressure **1** permitted for the tire. Always observe the recommended tire pressure for your vehicle when adjusting the tire pressure (→ page 373).

Information on tire composition



i The data in the illustration is shown as an example.

It describes the type of tire cord and the number of layers in the side wall **1** and under the tire tread **2**.

Tire size, load-bearing capacity, speed rating and load index

⚠ WARNING Risk of injury through exceeding the specified tire load-bearing capacity or the permissible speed rating

Exceeding the specified tire load rating or the permissible speed rating may lead to tire damage and to the tires bursting.

- ▶ Therefore, only use tire types and sizes approved for your vehicle model.
- ▶ Observe the tire load rating and speed rating required for your vehicle.

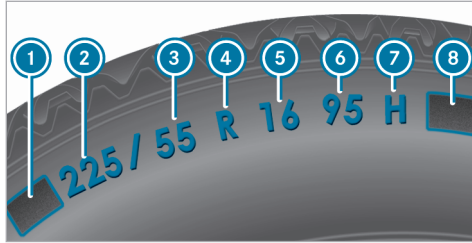

- ① Preceding letter
- ② Nominal tire width in millimeters
- ③ Aspect ratio in %
- ④ Tire code
- ⑤ Rim diameter
- ⑥ Load-bearing index
- ⑦ Speed rating
- ⑧ Load index

i The data in the illustration is shown as an example.

Information about interpreting tire data can be obtained from any qualified specialist workshop.

Preceding letter ①:

- None: passenger car tires according to European manufacturing standards.
- "P": passenger car tires according to US manufacturing standards.
- "LT": light truck tires according to US manufacturing standards.
- "T": compact emergency spare wheels with high tire pressure that are only designed for temporary use in an emergency.

Aspect ratio ③:

Ratio between tire height and tire width in percent (tire height divided by tire width).

Tire code ④ (tire type):

- "R" radial tire
- "D": bias ply tire
- "B": bias radial tire
- "ZR": radial tire with a maximum permissible speed above 149 mph (240 km/h) (optional)

Rim diameter ⑤:

The diameter of the bead seat (not the diameter of the rim flange). The rim diameter is specified in inches (in).

Load-bearing index ⑥:

Numerical code that specifies the maximum load-bearing capacity of a tire (e.g. "91" corresponds to 1356 lbs (615 kg)).

The load-bearing capacity of the tire must be at least half the gross axle weight rating of your vehicle. Do not overload the tires by exceeding the maximum permissible payload.

See also:

- Maximum permissible payload in the Tire and Loading Information table (→ page 377)
- Maximum tire load (→ page 383)
- Load index

Speed rating ⑦:

Specifies the maximum permissible speed of the tire.

- i** An electronic speed limiter prevents your vehicle from exceeding a speed of 130 mph (210 km/h).

Make sure that your tires have the required speed rating. You can obtain information on the required speed rating from a Mercedes-Benz service center.

Summer tires

Index	Speed rating
Q	up to 100 mph (160 km/h)
R	up to 106 mph (170 km/h)
S	up to 112 mph (180 km/h)
T	up to 118 mph (190 km/h)
H	up to 130 mph (210 km/h)
V	up to 149 mph (240 km/h)
W	up to 168 mph (270 km/h)

¹ "ZR" stated in the tire code.

² Or "M+S"  for winter tires.

Index	Speed rating
Y	up to 186 mph (300 km/h)
ZR...Y ¹	up to 186 mph (300 km/h)
ZR... (..Y) ¹	over 186 mph (300 km/h)
ZR ¹	over 149 mph (240 km/h)

- Specifying the speed rating as the "ZR" index in the tire code **4** is optional for tires up to 186 mph (300 km/h).
- If your tire code **4** includes "ZR" and there is no speed rating **7**, find out the maximum permissible speed from the tire manufacturer.
- If the load-bearing index **6** and speed rating **7** are in brackets, the maximum permissible speed of your tire is above 186 mph (300 km/h). To find out the maximum permissible speed, ask the tire manufacturer.

All-weather tires and winter tires

Index	Speed rating
Q M+S ²	up to 100 mph (160 km/h)
T M+S ²	up to 118 mph (190 km/h)
H M+S ²	up to 130 mph (210 km/h)
V M+S ²	up to 149 mph (240 km/h)

Winter tires bear the snowflake symbol  and fulfill the requirements of the Rubber Manufacturers Association (RMA) and the Rubber Association of Canada (RAC) regarding the tire traction on snow.

Load index **8**:

- No specification given: standard load (SL) tire
- "XL" or "Extra Load": extra load tire or reinforced tire
- "Light Load": light load tire

- "C", "D", "E": a load range that depends on the maximum load the tire can carry at a certain pressure.

Definition of terms for tires and loading

Tire structure and characteristics: describes the number of layers or the number of rubber-coated belts in the tire contact surface and the tire wall. These are made of steel, nylon, polyester and other materials.

Bar: metric unit for tire pressure. 14.5038 pounds per square inch (psi) and 100 kilopascal (kPa) is the equivalent of one bar.

DOT (Department of Transportation): DOT-marked tires fulfill the requirements of the US Department of Transportation.

Average weight of the vehicle occupants: the number of vehicle occupants for which the vehicle is designed, multiplied by 150 lb (68 kg).

Uniform tire quality grading standards: a uniform standard to grade the quality of tires with regard to tread quality, tire traction and temperature characteristics. The quality grading assessment is

made by the manufacturer following specifications from the U.S. government. The quality grade of a tire is imprinted on the side wall of the tire.

Recommended tire pressure: the recommended tire pressure is the tire pressure specified for the tires fitted to the vehicle at the factory.

The tire and load information table contains the recommended tire pressure for cold tires, the maximum permissible load and the maximum permissible vehicle speed.

The tire pressure table contains the recommended tire pressure for cold tires under various operating conditions, i.e. loading and/or speed of the vehicle.

Increased vehicle weight due to optional equipment: the combined weight of all standard and optional equipment available for the vehicle, regardless of whether it is actually installed on the vehicle or not.

Rim: the part of the wheel on which the tire is mounted.

GAWR (Gross Axle Weight Rating): the GAWR is the maximum gross axle weight rating. The actual load on an axle must never exceed the gross axle

weight rating. The gross axle weight rating can be found on the vehicle identification plate on the B-pillar on the driver's side.

Speed rating: the speed rating is part of the tire identification. It specifies the speed range for which a tire is approved.

GVW (Gross Vehicle Weight): the gross vehicle weight comprises the weight of the vehicle including fuel, tools, spare wheel, fitted accessories, occupants, luggage and the trailer tongue weight, if applicable. The gross vehicle weight must not exceed the gross vehicle weight rating GVWR as specified on the vehicle identification plate on the B-pillar on the driver's side.

GVWR (Gross Vehicle Weight Rating): the GVWR is the maximum permitted gross weight of the fully laden vehicle (weight of the vehicle including all accessories, occupants, fuel, luggage and the trailer tongue weight if applicable). The gross vehicle weight rating is specified on the vehicle identification plate on the B-pillar on the driver's side.

Maximum weight of the laden vehicle: the maximum weight is the sum of the unladen weight of the vehicle, the weight of the accessories, the

maximum load and the weight of optional equipment installed at the factory.

Kilopascal (kPa): metric unit for tire pressure. 6.9 kPa corresponds to 1 psi. Another unit for tire pressure is bar. 100 kilopascal (kPa) equals 1 bar.

Load index: in addition to the load-bearing index, the load index may also be imprinted on the side wall of the tire. This specifies the load-bearing capacity of the tire more precisely.

Unladen weight: the weight of a vehicle with standard equipment including the maximum capacity of fuel, service fluids and coolant. It also includes the air conditioning system and optional equipment if these are installed in the vehicle, but does not include passengers or luggage.

Maximum tire load: the maximum tire load is the maximum permissible weight in kilograms or lbs for which a tire is approved.

Maximum permissible tire pressure: maximum permissible tire pressure for one tire.

Maximum load on one tire: maximum load per tire. This is calculated by dividing the maximum axle load of one axle by two.

PSI (pounds per square inch): standard unit of measurement for tire pressure.

Aspect ratio: ratio between tire height and tire width in percent.

Tire pressure: pressure inside the tire applying an outward force to every square inch of the tire. The tire pressure is specified in pounds per square inch (psi), in kilopascals (kPa) or in bar. The tire pressure should only be corrected when the tires are cold.

Cold tire pressure: the tires are cold when the vehicle has been parked for at least 3 hours without direct sunlight on the tires, or the vehicle has been driven for less than 1 mile (1.6 km).

Tire contact surface: the part of the tire that comes into contact with the road.

Tire bead: the purpose of the tire bead is to ensure that the tire sits securely on the wheel rim. There are several wire cores in the tire bead to prevent the tire from changing length on the wheel rim.

Side wall: the part of the tire between the tread and the tire bead.

Weight of optional equipment: the combined weight of the optional equipment weighing more than the replaced standard parts and more than 5 lbs (2.3 kg). This optional equipment, such as high-performance brakes, level control system, a roof luggage rack or high-performance batteries, is not included in the unladen weight and the weight of the accessories.

TIN (Tire Identification Number): a unique identification number which can be used by a tire manufacturer to identify tires, for example in a product recall, and thus identify the purchasers. The TIN is made up of the manufacturer's identity code, tire size, tire type code and the manufacturing date.

Load-bearing index: the load-bearing index is a code that contains the maximum load-bearing capacity of a tire.

Traction: traction is the grip resulting from friction between the tire and the road surface.

Wear indicator: narrow bars (tread wear bars) that are distributed over the tire contact surface. If the tire tread is level with the bars, the wear limit of 1/16 in (1.6 mm) has been reached.

Distribution of vehicle occupants: distribution of vehicle occupants over designated seat positions in a vehicle.

Maximum permissible payload weight: nominal load and luggage load plus 150 lb (68 kg) multiplied by the number of seats in the vehicle.

Changing a wheel

Notes on selecting, installing and replacing tires

! **NOTE** Mercedes-AMG vehicles

▶ Observe the notes in the Supplement. You could otherwise fail to recognize dangers.

⚠ **WARNING** Risk of accident due to incorrect wheel and tire dimensions

If wheels and tires of the wrong size are installed, the service brakes or components in the brake system and in the wheel suspension may be damaged.

▶ Always replace wheels and tires with ones that fulfill the specifications of the original part.

For wheels, pay attention to the following:

- Designation
- Type

For tires, pay attention to the following:

- Designation
- Manufacturer
- Type

⚠ **WARNING** Risk of injury through exceeding the specified tire load-bearing capacity or the permissible speed rating

Exceeding the specified tire load rating or the permissible speed rating may lead to tire damage and to the tires bursting.

- ▶ Therefore, only use tire types and sizes approved for your vehicle model.
- ▶ Observe the tire load rating and speed rating required for your vehicle.

! **NOTE** Vehicle and tire damage caused by non-approved tire types and sizes

For safety reasons, only use tires, wheels and accessories which have been specially approved by Mercedes-Benz for your vehicle.

These tires are specially adapted to the active safety systems, such as ABS, ESP[®] and 4MATIC, and marked as follows:

- MO = Mercedes-Benz Original
- MOE = Mercedes-Benz Original Extended (tires with run-flat characteristics for certain wheels only)
- MO1 = Mercedes-Benz Original (only certain AMG tires)

Otherwise, certain properties, such as driving characteristics, vehicle noise emissions, consumption, etc. could be adversely affected. Furthermore, other tire sizes could result in the tires rubbing against the body and axle components when loaded. This could result in damage to the tire or the vehicle.

Only use tires, wheels and accessories that have been checked and recommended by Mercedes-Benz.

! **NOTE** Risk to driving safety from retreaded tires

Retreaded tires are neither tested nor recommended by Mercedes-Benz, since previous damage cannot always be detected on retreaded tires.

For this reason driving safety cannot be guaranteed.

- ▶ Do not use used tires if you have no information about their previous usage.

! **NOTE** Possible wheel and tire damage when driving over obstacles

Large wheels have a smaller section width. As the section width decreases, the risk of wheels and tires being damaged when driving over obstacles increases.

- ▶ Avoid obstacles or drive especially carefully.
- ▶ Reduce your speed when driving over curbs, speed bumps, manhole covers and potholes.
- ▶ Avoid particularly high curbs.

! **NOTE** Possible wheel and tire damage when parking on curbs or in potholes

Parking on curbs or in potholes can damage the wheels and tires.

- ▶ Only park on as level a surface as possible.
- ▶ Avoid curbs and potholes when parking.

! **NOTE** Damage to electronic components due to the use of mounting tools

Vehicles with a tire pressure monitoring system: there are electronic components in the wheel.

Using mounting tools in the area of the valve may damage the electronic components.

- ▶ Tire mounting tools should not be used in the area of the valve.
- ▶ Always have tires changed at a qualified specialist workshop.

! **NOTE** Damage to summer tires at low ambient temperatures

At low ambient temperatures, tears could form when driving with summer tires, causing permanent damage to the tires.

- ▶ At temperatures below 45 °F (7 °C) use  M+S tires.

Accessory parts which are not approved for your vehicle by Mercedes-Benz, or which are not used correctly, can impair the operating safety.

Before purchasing and using non-approved accessories, visit a qualified specialist workshop and inquire about:

- Suitability
- Legal stipulations
- Factory recommendations

⚠ WARNING Risk of accidents with sports tires

The special tire tread in combination with the optimized tire compound means that the risk of skidding or hydroplaning on wet roads is increased.

In addition, the tire grip is greatly reduced at a low outside temperature and tire running temperature.

- ▶ Switch on ESP® and adapt your driving style accordingly.
- ▶ Use  M+S tires at outside temperatures of less than 45°F (7°C).
- ▶ Only use tires suitable for the intended use.

Observe the following when selecting, installing and replacing tires:

- The use of certain tire types in certain regions and areas of operation can be advisable.
- Only use tires and wheels of the same type (summer tires, winter tires, MOExtended tires) and the same make.

- Only install wheels of the same size on one axle (left and right).
Only deviate from this in the event of a flat tire, to enable you to drive to a specialist workshop.
- **Vehicles with a tire pressure monitoring system:** all installed wheels must be equipped with functioning sensors for the tire pressure monitoring system.
- At temperatures below 45 °F (7 °C), use winter tires or all-season tire marked  M+S for all wheels.
Winter tires provide the best possible grip in wintry road conditions.
- When fitting M+S tires, only use tires with the same tread.
- Observe the maximum permissible speed for the M+S tires installed.
If the tire's maximum speed is below that of the vehicle, this must be indicated by an appropriate label in the driver's field of vision.
- Run-in new tires at moderate speeds for the first 60 miles (100 km).

- Replace the tires after six years at the latest, regardless of wear.
- **When replacing with tires that do not feature run-flat characteristics:** vehicles with MOExtended tires are not equipped with a TIREFIT kit at the factory. Equip the vehicle with a TIREFIT kit after fitting tires that do not feature run-flat characteristics, e.g. winter tires.

For more information on wheels and tires, contact a qualified specialist workshop.

Be sure to also observe the following further related topics:

- Notes on tire pressure (→ page 371)
- Tire and Loading Information table (→ page 377)
- Tire size, load-bearing capacity, speed rating and load index (→ page 384)
- Tire pressure table (→ page 373)
- Notes on the emergency spare wheel (→ page 398)

Notes on rotating wheels

⚠ WARNING Risk of injury through different wheel sizes

Rotating the front and rear wheels can severely impair the driving characteristics.

The wheel brakes or suspension components may also be damaged.

- ▶ Rotate front and rear wheels only if the wheels and tires are of the same dimensions.

Observe the instructions and safety notes on "Changing a wheel" (→ page 389).

The front and rear wheels are subject to different wear:

- Front wheels wear more on the tire shoulder
- Rear wheels wear more in the center of the tire

Do not drive with tires that have too little tread depth. This significantly reduces traction on wet roads (hydroplaning).

On vehicles that have the same size front and rear wheels, rotate the wheels according to the intervals in the tire manufacturer's warranty booklet in your vehicle documents. If this is not available, rotate the tires every 3,000 to 6,000 miles (5,000 to 10,000 km), depending on wear. Do not change the direction of wheel rotation.

Notes on storing wheels

When storing wheels, observe the following notes:

- After removing wheels, store them in a cool, dry and preferably dark place.
- Protect the tires from contact with oil, grease or fuel.

Overview of the tire-change tool kit

With the exception of some country-specific variants, vehicles are not equipped with a tire-change tool kit. For more information on which tire-changing tools are required and approved for performing a wheel change on your vehicle, consult a qualified specialist workshop.

Required tire-change tool kit may include, foreexample:

- Jack
- Chock
- Lug wrench

The tire-change tool kit **①** is located under the cargo floor.

i Depending on the model, the tire-change tool kit may be located in other positions under the cargo floor.

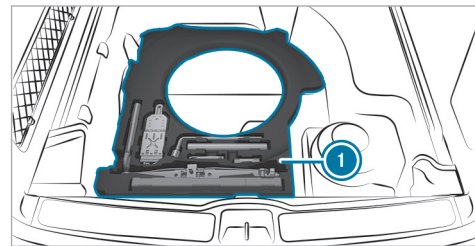

The tire-change tool kit includes the following:

- Jack

- Lug wrench
- Wheel studs
- Where applicable, extension piece for wheel studs (depending on vehicle version)
- Folding chock
- Ratchet wrench

Preparing the vehicle for a wheel change

Requirements:

- The vehicle is not on a slope.
 - The vehicle is on solid, non-slippery and level ground.
 - The required tire-change tool kit is available.
- i** If your vehicle is not equipped with the tire-change tool kit, consult a qualified specialist workshop to find out about suitable tools.
- ▶ Apply the electric parking brake manually.
 - ▶ Move the front wheels to the straight-ahead position.
 - ▶ Shift the transmission to position **P**.

- ▶ **Vehicles with level control:** set the normal vehicle level (→ page 234).
- ▶ Switch off the vehicle.
- ▶ Make sure that the vehicle cannot be started.
- ▶ Place chocks or other suitable items under the front and rear of the wheel that is diagonally opposite the wheel you wish to change.
- ▶ Raise the vehicle (→ page 394).

Removing and installing wheel trim/hub caps

Requirements

- The vehicle is prepared for a wheel change (→ page 393).

Plastic hub cap

Removing:

- ▶ Turn the center cover of the hub cap counter-clockwise and remove the hub cap.

Installing:

- ▶ Make sure that the center cover of the hub cap has been turned counter-clockwise.

- ▶ Position the hub cap and turn the center cover clockwise until the hub cap is felt and heard to engage.

Aluminum hub cap

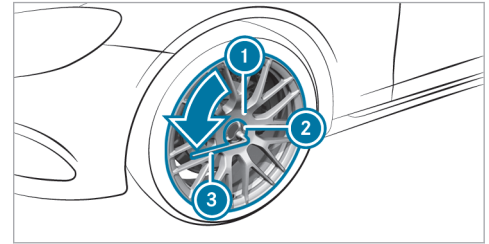

Removing:

- ▶ Position socket **2** from the tire-change tool kit on hub cap **1**.
- ▶ Position wheel wrench **3** on socket **2**.
- ▶ Using wheel wrench **3** to turn the hub cap **1** counter-clockwise and remove it.

Installing:

- ▶ Follow the instructions above in reverse order.

i Specified tightening torque: 18 lb-ft (25 Nm).

Raising the vehicle when changing a wheel

Requirements:

- There are no persons in the vehicle.
- The vehicle has been prepared for a wheel change (→ page 393).

Important notes on using the jack:

- Use only a vehicle-specific jack that has been approved by Mercedes-Benz to raise the vehicle.
- The jack is only designed for raising and holding the vehicle for a short time while a wheel is being changed and not for maintenance work under the vehicle.
- The jack must be placed on a firm, level and non-slip surface. If necessary, use a large, flat, load-bearing, non-slip underlay.
- The foot of the jack must be positioned vertically under the jack support point.

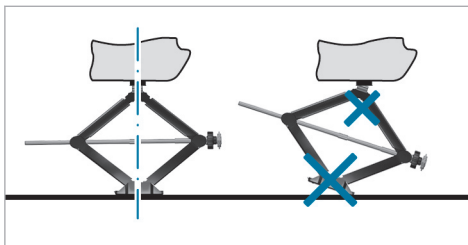

Rules of conduct when the vehicle is raised:

- Do not put your hands or feet under the vehicle.
- Do not lie under the vehicle.
- Do not start the vehicle and do not release the electric parking brake.
- Do not open or close any doors or the tailgate.

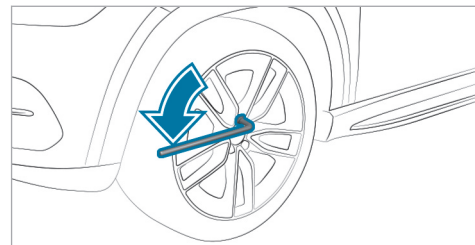

▶ Using the wheel wrench, loosen the wheel bolts on the wheel you wish to change by about one full turn. Do not unscrew the bolts completely.

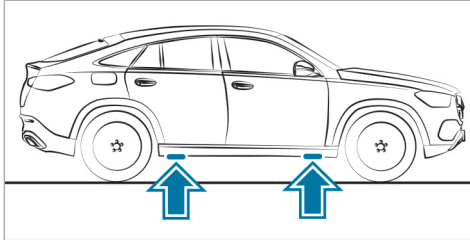

Position of the jack support points

⚠ WARNING Risk of injury from incorrect positioning of the jack

If you do not position the jack correctly at the appropriate jacking point of the vehicle, the jack could tip with the vehicle raised.

- ▶ Only position the jack at the appropriate jacking point of the vehicle. The base of the jack must be positioned vertically under the jacking point of the vehicle.

! NOTE Damage to the vehicle due to the jack

If you do not position the jack at the jack support points provided for this purpose, you could damage your vehicle.

- ▶ Only position the jack at the jack support points provided for this purpose.

- ▶ Take the ratchet wrench out of the tire-change tool kit and place it on the hexagon nut of the jack so that the letters "AUF" are visible.

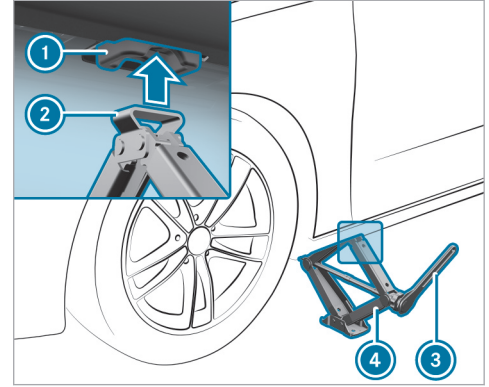

- ▶ Position support **2** of jack **4** on jack support point **1**.
- ▶ Turn ratchet wrench **3** clockwise until jack support **2** sits completely on jack support point **1** and the base of the jack lies evenly on the ground.

- ▶ Continue to turn ratchet wrench  until the tire is raised a maximum of 1.2 in (3 cm) off the ground.
- ▶ Loosen and remove the wheel (→ page 396).

Removing a wheel

Requirements:

- The vehicle is raised (→ page 394).

NOTE Mercedes-AMG vehicles

- ▶ Observe the notes in the Supplement. You could otherwise fail to recognize dangers.

When changing a wheel, avoid applying any force to the brake discs, since this could impair the level of comfort when braking.

NOTE Damage to threading from dirt on wheel bolts

- ▶ Do not place wheel bolts in sand or on a dirty surface.

- ▶ Completely unscrew the wheel bolts.
- ▶ Remove the wheel.

Fitting a new wheel

Requirements

- The wheel that is to be replaced is removed (→ page 396).

NOTE Mercedes-AMG vehicles

- ▶ Observe the notes in the Supplement. You could otherwise fail to recognize dangers.

WARNING Risk of accident from losing a wheel

Oiled, greased or damaged wheel bolt/wheel nut threads or wheel hub/wheel mounting bolt threads can cause the wheel bolts/wheel nuts to come loose.

- ▶ Never oil or grease the threads.

- ▶ In the event of damage to the threads, contact a qualified specialist workshop immediately.
- ▶ Have the damaged wheel bolts or damaged hub threads replaced.
- ▶ Do not continue driving.

- ▶ Observe the information on the choice of tires (→ page 389).

For tires with a specified direction of rotation, an arrow on the side wall of the tire indicates the correct direction of rotation. Observe the direction of rotation when installing.

- ▶ Place the wheel to be installed on the wheel hub and push it on.

WARNING Risk of injury from tightening wheel bolts and nuts

If you tighten the wheel bolts or wheel nuts when the vehicle is raised, the jack could tip.

- ▶ Only tighten wheel bolts or wheel nuts when the vehicle is on the ground.

- ▶ Observe the instructions and safety notes on "Changing a wheel" (→ page 389).
- ▶ For safety reasons, only use wheel bolts which have been approved by Mercedes-Benz and for the wheel in question.

! **NOTE** Paint damage to the rim when inserting the first wheel bolt

If the wheel has too much free play when inserting the first wheel bolt, there is a risk of damaging the paintwork on the rim.

- ▶ When inserting the first wheel bolt, be sure to apply sufficient pressure to the wheel hub.

- ▶ Tighten the wheel bolts evenly in a diagonal pattern in the order indicated until they are finger-tight.
- ▶ If the collapsible spare wheel has been installed, inflate the collapsible spare wheel (→ page 401).
- ▶ Lower the vehicle (→ page 397).

Lowering the vehicle after a wheel change

Requirements

- The new wheel has been installed (→ page 396).

Observe the information on tire pressure (→ page 371).

- ▶ Place the ratchet wrench onto the hexagon nut of the jack so that the lettering "AB" is visible.
- ▶ **To lower the vehicle:** turn the ratchet wrench of the jack counter-clockwise.

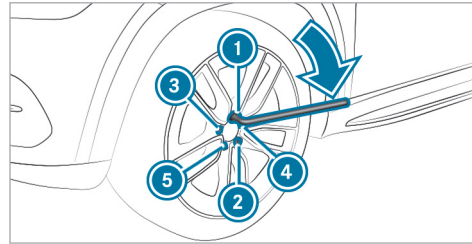

- ▶ Tighten the wheel bolts evenly in a diagonal pattern in the order indicated ① to ⑤ with a maximum of 59 lb-ft (80 Nm).
- ▶ Then tighten the wheel bolts evenly in a diagonal pattern in the order indicated ① to ⑤ the specified tightening torque of 111 lb-ft (150 Nm).

! **WARNING** Risk of accident due to incorrect tightening torque

The wheels could come loose if the wheel bolts or wheel nuts are not tightened to the prescribed torque.

- ▶ Ensure that the wheel bolts or wheel nuts are tightened to the prescribed tightening torque.
- ▶ If you are not sure, do not move the vehicle. Contact a qualified specialist workshop and have the tightening torque checked immediately.

- ▶ Check the tire pressure of the newly mounted wheel and adjust accordingly.

i The following does not apply if the new wheel is an emergency spare wheel.

▶ Vehicles with a tire pressure monitoring system: restart the tire pressure monitoring system (→ page 376).

Emergency spare wheel

Notes on the emergency spare wheel

⚠ WARNING Risk of accident caused by incorrect wheel and tire dimensions

The wheel or tire sizes and the tire type of the emergency spare wheel or spare wheel and the wheel to be replaced may differ. The emergency spare wheel or spare wheel can significantly impair driving characteristics of the vehicle.

To prevent hazardous situations:

- ▶ Drive carefully.
- ▶ Never install more than one emergency spare wheel or spare wheel that differs in size.

- ▶ Only use an emergency spare wheel or spare wheel briefly.
- ▶ Do not deactivate ESP®.
- ▶ Have the emergency spare wheel or spare wheel of a different size replaced at the nearest qualified specialist workshop. The new wheel must have the correct dimensions.

i The emergency spare wheel is secured in the load compartment under the load compartment floor.

Observe the following notes on installing an emergency spare wheel:

- The maximum permissible speed with an emergency spare wheel installed is 50 mph (80 km/h).
- Do not install the emergency spare wheel with snow chains.
- Replace the emergency spare wheel after six years at the latest, regardless of wear.
- Use the included wheel bolts for the emergency spare wheel.

- Check the tire pressure of the emergency spare wheel when installed. Correct the pressure as necessary.

i The specified tire pressure is stated on the label of the emergency spare wheel.

i **Vehicles with tire pressure monitoring system:** if an emergency spare wheel is installed, the tire pressure monitoring system cannot function reliably. For a few minutes after an emergency spare wheel is installed, the system may still display the tire pressure of the removed wheel. Only restart the system when the emergency spare wheel has been replaced with a new wheel.

Be sure to observe the following further related topics:

- Notes on tire pressure (→ page 371)
- Tire and load information placard (→ page 377)
- Tire pressure table (→ page 373)
- Notes on installing tires (→ page 389)
- Installing an emergency spare wheel (→ page 393)

Inflating the emergency spare wheel

NOTE Overheating due to the tire inflation compressor running too long

Do not run the tire inflation compressor for longer than ten minutes without interruption.

Requirements

- The emergency spare wheel has been installed correctly. (→ page 393)
- Comply with the manufacturer's safety notes on the sticker of the emergency spare wheel and on the tire inflation compressor.
- Remove the sticker with the label 50 mph (80 km/h) from the tire inflation compressor housing and affix it to the instrument cluster within the driver's field of vision.
- Remove the tire inflation compressor from the stowage space under the load compartment floor. (→ page 350)

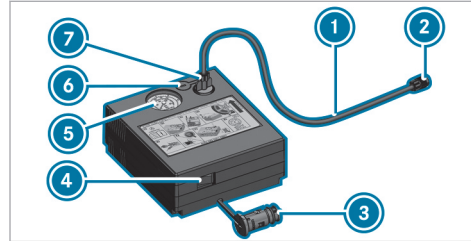

- Pull the filling hose ① and plug ③ out of the tire inflation compressor housing.
- Insert plug ⑦ of filling hose ① in the socket on the tire inflation compressor and then turn it until plug ⑦ engages.
- Unscrew the cap from the valve on the emergency spare wheel.
- Screw union nut ② of filling hose ① onto the valve.
- Make sure the on and off switch ④ of the tire inflation compressor is set to **0**.
- Insert the plug ③ into a socket in your vehicle.

- Cigarette lighter socket
- 12 -V- socket: (→ page 128)
- Observe the notes on the cigarette lighter in the Digital Owner's Manual
- Observe the notes on sockets: (→ page 128)
- Press the start/stop button once to switch on the power supply (→ page 155).
- Press the on and off switch ④ on the tire inflation compressor to **I**. The tire inflation compressor is switched on. The tire is inflated. The tire pressure appears on manometer ⑤.
- Inflate the tire to the specified tire pressure.
- The specified tire pressure is stated on the label of the emergency spare wheel.
- When the specified tire pressure has been reached, press on and off switch ④ on the tire inflation compressor to **0**. The tire inflation compressor is switched off.
- Press the start/stop button to switch off the power supply.

- ▶ If the tire pressure is higher than the specified pressure, press the pressure release valve button ⑥ until the correct tire pressure has been reached.
- ▶ Unscrew union nut ② of filling hose ① from the valve.
- ▶ Screw the valve cap of the emergency spare wheel onto the valve again.
- ▶ Stow the filling hose ① and plug ③ in the lower section of the tire inflation compressor housing.
- ▶ Stow the tire inflation compressor in the vehicle.

Collapsible spare wheel

Notes on the collapsible spare wheel

⚠ WARNING Risk of accident caused by incorrect wheel and tire dimensions

The wheel or tire sizes and the tire type of the emergency spare wheel or spare wheel and the wheel to be replaced may differ. The emer-

gency spare wheel or spare wheel can significantly impair driving characteristics of the vehicle.

To prevent hazardous situations:

- ▶ Drive carefully.
- ▶ Never install more than one emergency spare wheel or spare wheel that differs in size.
- ▶ Only use an emergency spare wheel or spare wheel briefly.
- ▶ Do not deactivate ESP®.
- ▶ Have the emergency spare wheel or spare wheel of a different size replaced at the nearest qualified specialist workshop. The new wheel must have the correct dimensions.

The collapsible spare wheel is an emergency spare wheel that is only suitable for temporary use under restricted conditions following a flat tire (e.g. to the nearest workshop).

The tire sidewalls are folded when uninflated. Before using the collapsible spare wheel, inflate it with the compressor supplied.

Check the tire pressure of the collapsible spare wheel once installed. Correct the pressure as necessary.

The maximum permissible speed with an installed collapsible spare wheel is 50 mph (80 km/h).

Do not mount snow chains on the collapsible spare wheel.

Replace the collapsible spare wheel after six years at the latest, regardless of wear.

i Vehicles with a tire pressure monitoring system: if a collapsible spare wheel is installed, the tire pressure monitoring system cannot function reliably. The system may still display the tire pressure of the removed wheel for a few minutes. Only restart the system when the collapsible spare wheel has been replaced with a new wheel.

Be sure to also observe the following further related topics:

- Notes on tire pressure (→ page 371)

- Tire pressure table (→ page 373)

Removing the collapsible spare wheel

The collapsible spare wheel is located under the load compartment floor.

- ▶ Observe the information on mounting tires (→ page 389).
- ▶ Open the tailgate.
- ▶ Open the load compartment floor.
- ▶ Remove the collapsible spare wheel.

Inflating the collapsible spare wheel

Requirements:

- Install the collapsible spare wheel as described .
- Remove the tire inflation compressor from the stowage space under the cargo floor (→ page 350).

! **NOTE** Damage to the collapsible spare wheel when lowering the vehicle

Lowering the vehicle without previously inflating the collapsible spare wheel can damage its rim.

- ▶ Inflate the collapsible spare wheel using the tire inflation compressor before lowering the vehicle.

! **NOTE** Overheating due to the tire inflation compressor running too long

- ▶ Do not run the tire inflation compressor for longer than ten minutes without interruption.

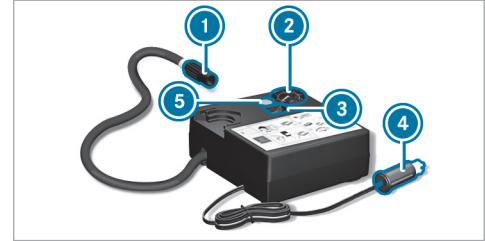

- ▶ Pull connector ④ and the hose out of the housing.
- ▶ Unscrew the cap from the valve on the collapsible spare wheel.
- ▶ Screw union nut ① of the hose onto the valve.
- ▶ Make sure the on/off switch ③ of the tire inflation compressor is set to 0.
- ▶ Insert the plug ④ into the cigarette lighter socket or into a 12-V-socket (→ page 128) in your vehicle.
- ▶ Switch on the power supply (→ page 155).

402 Wheels and tires

- ▶ Press on/off switch ③ on the tire inflation compressor to **I**.
The tire inflation compressor is switched on.
The tire is inflated. The tire pressure is shown on the manometer ②.
- ▶ Inflate the tire to the specified tire pressure.
- ① The specified tire pressure is printed in yellow on the collapsible spare wheel.
- ▶ When the specified tire pressure has been reached, press on/off switch ③ on the tire inflation compressor to **0**.
- ▶ If the tire pressure is higher than the specified pressure, press pressure release valve button ⑤ until the correct tire pressure has been reached.

Notes on technical data

! NOTE Mercedes-AMG vehicles

- ▶ Observe the notes in the Supplement. You could otherwise fail to recognize dangers.

The data stated only applies to vehicles with standard equipment. You can obtain further information from an authorized Mercedes-Benz Center.

Vehicle electronics

Two-way radios

| Notes on installing two-way radios

! WARNING Risk of accident due to improper work on two-way radios

If two-way radios are manipulated or retrofitted incorrectly, the electromagnetic radiation from the two-way radios can interfere with the

vehicle electronics and jeopardize the operating safety of the vehicle.

- ▶ You should have all work on electrical and electronic components carried out at a qualified specialist workshop.

! WARNING Risk of accident due to improper operation of two-way radios

If you use two-way radios in the vehicle improperly, their electromagnetic radiation can disrupt the vehicle's electronics. This is the case in the following situations, in particular:

- The two-way radio is not connected to an exterior antenna.
- The exterior antenna is installed incorrectly or is not a low-reflection antenna.

This could jeopardize the operating safety of the vehicle.

- ▶ Have the low-reflection exterior antenna installed at a qualified specialist workshop.

- ▶ When operating two-way radios in the vehicle, always connect them to the low-reflection exterior antenna.

! NOTE Invalidation of the operating permit due to failure to comply with the instructions for installation and use

The operating permit may be invalidated if the instructions for installation and use of two-way radios are not observed.

- ▶ Only use approved frequency bands.
- ▶ Observe the maximum permissible output power in these frequency bands.
- ▶ Only use approved antenna positions.

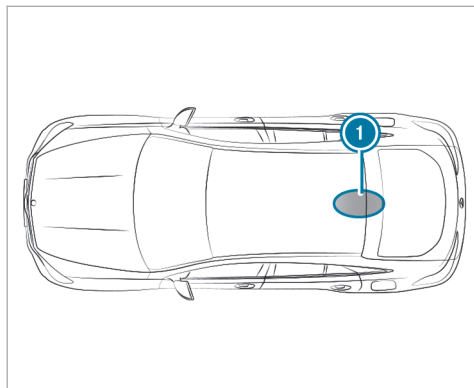

① Rear roof area

Installing a roof antenna on a vehicle with a panorama roof with power tilt/sliding panel is not permitted.

Use Technical Specification ISO/TS 21609 (Road Vehicles - "EMCs for installation of aftermarket radio frequency transmitting equipment") when

retrofitting two-way radios. Comply with the legal requirements for detachable parts.

If your vehicle is equipped with the pre-installation for a two-way radio, use the power supply and antenna connectors provided in the pre-installation. Observe the manufacturer's supplements when installing.

■ Mobile phone transmission output

The maximum transmission output (PEAK) at the base of the antenna must not exceed the values in the following table.

Frequency band and maximum transmission output

Frequency band	Maximum transmission output
2-m- frequency band 144 - 174 MHz	50 W
Terrestrial Trunked Radio (TETRA) 380 - 460 MHz	10 W

Frequency band	Maximum transmission output
Mobile phone 2G	2 W
Mobile phone 3G/4G/5G	0.5 W

The following can be used in the vehicle without restrictions:

- two-way radios with a maximum transmission output of up to 100 mW
- two-way radios with transmitter frequencies in the 380 -410 MHz frequency band and a maximum transmission output of up to 2 W (TETRA)
- mobile phones (2G/3G/4G/5G)

There are no restrictions regarding the positioning of the antenna on the outside of the vehicle for the following frequency bands:

- Terrestrial Trunked Radio (TETRA)
- 2G/3G/4G/5G

Radio regulations

Regulatory radio identifiers and specific notes

Manufacturer information about radio-based vehicle components can be found using the key phrase "Regulatory radio information" in the Digital Operator's Manual in the vehicle, on the internet and in the app.

Further information and updates are available at the following web address:

[https://
regulatoryradioinformation.corpinter.net/us](https://regulatoryradioinformation.corpinter.net/us)



information" in the vehicle's Digital Operator's Manual, on the Internet and in the app.

Further information and updates are available at the following web address:

[https://
regulatoryradioinformation.corpinter.net/us](https://regulatoryradioinformation.corpinter.net/us)



Vehicle identification plate, VIN and engine number overview

Vehicle identification plate

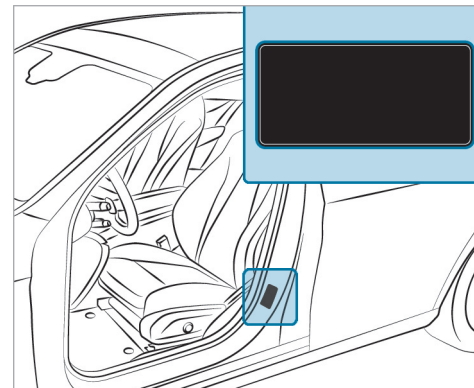

Information about the specific absorption rate (SAR)

Information on the specific absorption rate (SAR) can be found under the key word "Regulatory

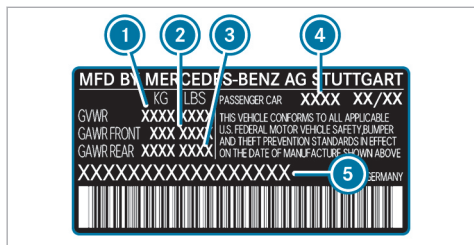

Vehicle identification plate (USA only)

- ① Permissible gross mass
- ② Maximum permissible front axle load
- ③ Maximum permissible rear axle load
- ④ Paint code
- ⑤ VIN (vehicle identification number)

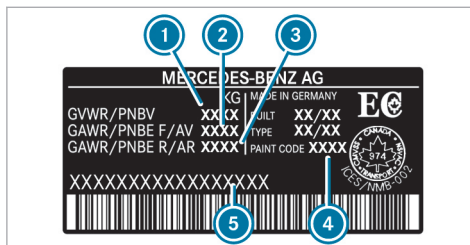

Vehicle identification plate (Canada only)

- ① Permissible gross mass
- ② Maximum permissible front axle load
- ③ Maximum permissible rear axle load
- ④ Paint code
- ⑤ VIN (vehicle identification number)

The permissible gross mass comprises the vehicle weight, all vehicle occupants, the fuel and the load. The maximum gross axle weight rating is the maximum weight that can be carried on one axle (front- or rear axle).

Never exceed the permissible gross mass or the maximum gross axle weight rating for the front- or rear axle.

VIN in front of the front seat

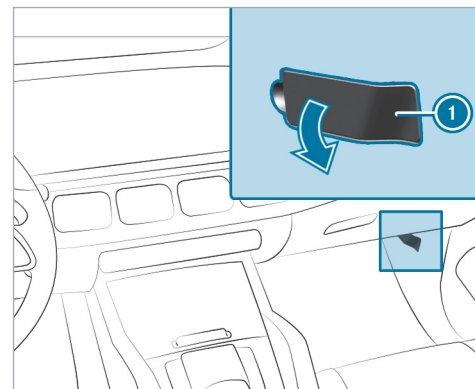

- ① VIN (vehicle identification number)

Additional plates

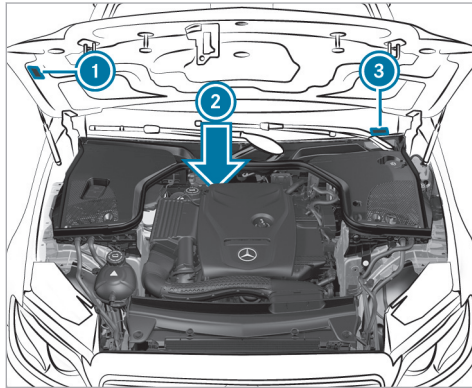

- ① Plate with information regarding emissions testing, including confirmation of emissions guidelines at the U.S. federal level and for California
- ② Engine number stamped into the crankcase
- ③ VIN (vehicle identification number) as a label at the lower edge of the windshield

Operating fluids

Notes on operating fluids

! NOTE Mercedes-AMG vehicles

- ▶ Observe the notes in the Supplement. You could otherwise fail to recognize dangers.

⚠ WARNING Risk of injury due to harmful operating fluids

Operating fluids can be toxic.

- ▶ When using, storing and disposing of operating fluids, observe the imprints on the respective original containers.
- ▶ Always keep operating fluids in the sealed original container.
- ▶ Always keep children away from operating fluids.

🔥 ENVIRONMENTAL NOTE Pollution of the environment due to irresponsible disposal of operating fluids

Incorrect disposal of operating fluids can cause considerable damage to the environment.

- ▶ Dispose of operating fluids in an environmentally responsible manner.

Operating fluids include the following:

- Fuels
- Lubricants
- Coolant
- Brake fluid
- Windshield washer fluid
- Climate control system refrigerant

Only use products approved by Mercedes-Benz. Damage caused by the use of products that have not been approved is not covered by the Mercedes-Benz warranty or goodwill gestures.

The operating fluids approved by Mercedes-Benz can be identified by the following inscriptions on the container:

- MB-Freigabe (e.g. MB-Freigabe 229.51)
- MB-Approval (e.g. MB-Approval 229.51)

Further information on approved operating fluids:

- in the Mercedes-Benz Specifications for Operating Fluids by entering the designation
 - At <https://operatingfluids.mercedes-benz.com>
- At a qualified specialist workshop

▲ WARNING Risk of fire or explosion from fuel

Fuels are highly flammable.

- ▶ Fire, open flames, smoking and creating sparks must be avoided.
- ▶ Before and during refueling, switch off the vehicle and, if installed, the stationary heater.

▲ WARNING Risk of injury from fuels

Fuels are poisonous and hazardous to your health.

- ▶ Do not swallow fuel or let it come into contact with skin, eyes or clothing.
- ▶ Do not inhale fuel vapor.
- ▶ Keep children away from fuel.
- ▶ Keep doors and windows closed during the refueling process.

If you or other people come into contact with fuel, observe the following:

- ▶ Immediately rinse fuel off your skin with soap and water.
- ▶ If fuel comes into contact with your eyes, immediately rinse them thoroughly with clean water. Seek medical attention immediately.
- ▶ If you swallow fuel, seek medical attention immediately. Do not induce vomiting.

- ▶ Change immediately out of clothing that has come into contact with fuel.

Flexible-fuel vehicles can be refueled with the following fuel types:

- premium-grade unleaded gasoline
- E85 fuel
- a mixture of E85 fuel and premium-grade unleaded gasoline

Flexible-fuel vehicles can be identified by the **Ethanol up to E85** sticker on the inside of the fuel filler flap.

Depending on the country, the fuels you can use in your vehicle may differ from the information in the Operator's Manual. The fuels that have been approved for your vehicle can be found on the instruction label on the inside of the fuel filler flap.

Fuel

Information on fuel quality for vehicles with gasoline engine

Observe the notes on operating fluids (→ page 407).

! NOTE Damage caused by the wrong fuel

Even small amounts of the wrong fuel could result in damage to the fuel system, the engine and the emission control system.

- ▶ Refuel only with low-sulfur spark-ignition engine fuel.

This fuel may contain up to 10% ethanol by volume. Your vehicle is suitable for use with E10 fuel.

Never refuel with any of the following fuels:

- Diesel
- gasoline with more than 10% Ethanol, z.B. E15, E85, E100

- gasoline with more than 3% methanol by volume, e.g. M15, M30, M85, M100
- gasoline with metallic additives

If you have accidentally refueled with the wrong fuel:

- ▶ Do not switch on the vehicle.
- ▶ Consult a qualified specialist workshop.

If the available fuel is not sufficiently low in sulfur, it may produce unpleasant odors.

Only fill up with fuel that has at least the octane rating specified on the information label on the fuel filler flap (→ page 179).

For maximum engine output: Only fill up with premium-grade unleaded gasoline with an octane rating of at least 91 AKI/95 RON.

If the recommended fuel is not available, you may also temporarily use regular unleaded gasoline with an octane rating of at least 87 AKI/91 RON. This may reduce engine output and increase fuel consumption.

i **Vehicle with M 256M gasoline engine:** when you use 91 AKI/95 RON, there may be slight

limitations in performance that have no further consequences.

Never fill up with gasoline with an even lower RON.

! NOTE Premature engine wear through unleaded regular gasoline

Impairment of the longevity and performance of the engine.

If unleaded premium grade gasoline is unavailable and you have to refuel using unleaded regular gasoline:

- ▶ Only fill the fuel tank to half full with unleaded regular gasoline and refill as soon as possible with unleaded premium grade gasoline.
- ▶ Do not drive at the maximum design speed.
- ▶ Avoid sudden acceleration and engine speeds over 3000 rpm.

Further information on fuel is available in the following locations:

- At a gas station
- At a qualified specialist workshop
- **USA only:** on the <https://www.mbusa.com>

Information on additives in gasoline (vehicles with gasoline engine)

Observe the notes on operating fluids (→ page 407).

! **NOTE** Damage from use of unsuitable additives

Even small amounts of the wrong additive may lead to malfunctions occurring.

- ▶ Only add cleaning additives recommended by Mercedes-Benz to the fuel.

Mercedes-Benz recommends that you use brand-name fuels with additives.

In some countries, the fuel available may not have sufficient additives. Deposits could build up in the fuel injection system as a result. In this case, in consultation with a qualified specialist workshop

(e.g. an authorized Mercedes-Benz Service Center), mix the fuel with the cleaning additive recommended by Mercedes-Benz. Observe the notes and mixing ratios indicated on the tank.

Tank content and fuel reserve

Total fuel tank capacity

Model	
GLE 450 4MATIC	22.5 gal (85.0 liters)

Fuel tank reserve

Model	
GLE 450 4MATIC	2.4 gal (9.0 liters)

Engine oil

Notes on engine oil

Observe the notes on operating fluids (→ page 407).



! **NOTE** Engine damage caused by an incorrect oil filter, incorrect oil or additives

- ▶ Do not use engine oils or oil filters other than those which meet the specifications necessary for the prescribed service intervals.
- ▶ Do not alter the engine oil or oil filter in order to achieve longer change intervals than prescribed.
- ▶ Do not use additives.
- ▶ Have the engine oil changed after the prescribed intervals.

Mercedes-Benz recommends having the oil changed at a qualified specialist workshop.

Only use engine oils approved for your vehicle by Mercedes-Benz.

■ Engine oil quality and filling quantity

Missing values were not available by the editorial deadline.

Engine oil specifications (gasoline engines)

Model	MB-Freigabe or MB-Approval
GLE 450 4MATIC	

* Recommended for the lowest possible fuel consumption (lowest SAE viscosity class in each case; observe possible restrictions of the approved SAE viscosity classes)

To achieve the lowest possible fuel consumption, it is recommended to use the engine oil specifications marked in the table with the lowest SAE viscosity class in each case. Possible restrictions of the approved SAE viscosity classes must be observed.

The following values refer to an oil change, including the oil filter.

Engine oil filling quantity

Model	Quantity
GLE 450 4MATIC	

Notes on brake fluid

Please observe the notes on operating fluids (→ page 407).

⚠ WARNING Risk of an accident due to vapor pockets forming in the brake system

The brake fluid constantly absorbs moisture from the air. This lowers the boiling point of the brake fluid. If the boiling point is too low, vapor pockets may form in the brake system when the brakes are applied hard.

This causes the braking effect to be impaired.

- ▶ Have the brake fluid renewed at the specified intervals.

Have the brake fluid regularly replaced at a qualified specialist workshop.

Only use a brake fluid according to MB-Freigabe or MB-Approval 331.0 approved by Mercedes-Benz.

Coolant

■ Notes on coolant

Observe the notes on operating fluids (→ page 407).

⚠ WARNING - Risk of fire and injury from antifreeze

If antifreeze comes into contact with hot component parts in the engine compartment, it may ignite.

- ▶ Allow the engine to cool down before adding antifreeze.
- ▶ Make sure that no antifreeze spills out next to the filler opening.
- ▶ Thoroughly clean off any antifreeze from component parts before starting the vehicle.

! **NOTE** Damage caused by incorrect coolant

▶ Only use coolant that has been premixed with the required antifreeze protection.

Information on coolant is available at the following locations:

- In the Mercedes-Benz Specification for Operating Fluids 320.1
 - At <https://operatingfluids.mercedes-benz.com>
- At a qualified specialist workshop

! **NOTE** Overheating at high outside temperatures

If an inappropriate coolant is used, the cooling system is not sufficiently protected against overheating and corrosion at high outside temperatures.

▶ Only use coolant approved for Mercedes-Benz.

▶ Observe the instructions in the Mercedes-Benz Specifications for Operating Fluids 320.1.

Have the coolant regularly replaced at a qualified specialist workshop.

Proportion of antifreeze concentrate in the cooling system:

- A minimum of 50% (antifreeze protection down to about -35°F (-37°C))
- A maximum of 55% (antifreeze protection down to -49°F (-45°C))

■ Coolant filling capacity

Missing values were not available at the time of going to press.

Coolant (engine)

Model	Capacity
GLE 450 4MATIC	

Notes on windshield washer fluid

Observe the notes on operating fluids (→ page 407).

! **WARNING** - Risk of fire and injury from windshield washer concentrate

Windshield washer concentrate is highly flammable. It could ignite if it comes into contact with hot engine component parts or the exhaust system.

▶ Make sure that no windshield washer concentrate spills out next to the filler opening.

! **NOTE** Damage to the exterior lighting due to unsuitable windshield washer fluid

Unsuitable windshield washer fluid may damage the plastic surface of the exterior lighting.

▶ Only use windshield washer fluid which is also suitable for use on plastic surfaces, e.g. MB SummerFit or MB WinterFit.

! **NOTE** Blocked spray nozzles caused by mixing windshield washer fluids

▶ Do not mix MB SummerFit and MB WinterFit with other windshield washer fluids.

Do not use distilled or de-ionised water. Otherwise, the fill level sensor may be triggered erroneously.

Recommended windshield washer fluid:

- Above freezing point: e.g. MB SummerFit
- Below freezing point: e.g. MB WinterFit

For the correct mixing ratio, refer to the information on the antifreeze container.

Mix washing water with windshield washer fluid all year round.

Refrigerant

Notes on refrigerant

Observe the notes on operating fluids (→ page 407).

i Your vehicle's climate control system may be filled with R-134a or R-1234yf refrigerant. R-1234yf refrigerant should be used only for certain vehicle models.

! **NOTE** Damage due to incorrect refrigerant

If a non-approved refrigerant is used, the climate control system may be damaged.

▶ Use only the refrigerant approved for your vehicle.

! **NOTE** Damage to the climate control system due to incorrect refrigerant compressor oil

▶ Only use refrigerant compressor oil that has been approved by Mercedes-Benz.

▶ Do not mix the approved refrigerant compressor oil with a different refrigerant compressor oil.

The refrigerant type for your vehicle can be found on the information label of the climate control system. The information label is located on the inside of the hood.

Work on the climate control system may be carried out only at a qualified specialist workshop. All applicable regulations as well as SAE standard J639 must be adhered to.

Have all work on the climate control system carried out at a qualified specialist workshop.

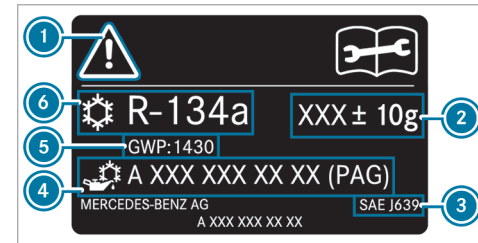

Refrigerant information label (example: R-134a)

- 1 Hazard and service warning symbols
- 2 Refrigerant filling capacity
- 3 Applicable standards
- 4 PAG oil part number

- ⑤ Global warming potential of refrigerant used
- ⑥ Refrigerant type

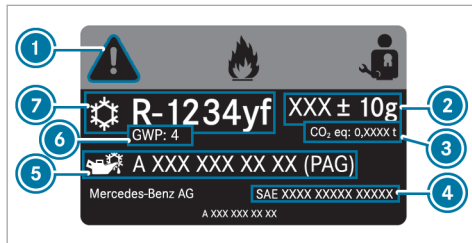

Refrigerant information label (example: R-1234yf)

- ① Hazard and service warning symbols
- ② Refrigerant filling capacity
- ③ CO₂ equivalent of the refrigerant used
- ④ Applicable standards
- ⑤ PAG oil part number
- ⑥ GWP (global warming potential) of the refrigerant used
- ⑦ Refrigerant type

Symbols ① indicate the following:

- Possible dangers
- Maintenance work to be carried out at a qualified specialist workshop

■ Filling capacity for refrigerant and PAG oil

Missing values were not available at the time of going to press.

Refrigerant filling capacity

Model	Capacity
GLE 450 4MATIC	

Filling capacity for PAG oil

Model	Capacity
GLE 450 4MATIC	

Vehicle data

Vehicle dimensions

The heights specified may vary as a result of the:

- Tires
- Load
- Condition of the suspension
- Special equipment

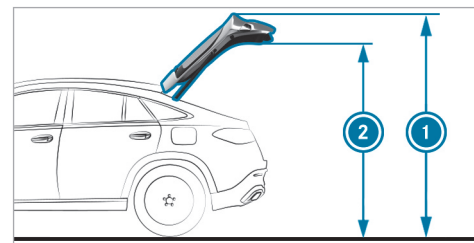

Height when open and headroom

	① Height when open*	② Headroom*
Vehicles with steel suspension	90.8 in (2307 mm)	77.6 in (1971 mm)
Vehicles with AIR-MATIC	89.2 in (2266 mm) - 92.1 in (2341 mm)	76.0 in (1931 mm) - 78.9 in (2006 mm)

*When rear-end lowering is activated, the values will be lower accordingly.

Vehicle dimensions

GLE 450 4MATIC	
Vehicle length	194.5 in (4941 mm)
Vehicle width including exterior mirrors	84.9 in (2157 mm)

GLE 450 4MATIC

Vehicle height (steel suspension)	68.1 in (1730 mm)
Maximum vehicle height (AIR-MATIC)	69.5 in (1766 mm)
Wheelbase	115.5 in (2935 mm)
Maximum ground clearance (steel suspension)	8.1 in (205 mm)
Maximum ground clearance (AIRMATIC)	9.8 in (250 mm)
Minimum ground clearance (AIRMATIC)	6.9 in (175 mm)
Turning radius	38.9 ft (11.87 m)

Weights and loads

Please observe the following notes for the specified vehicle data:

- Items of special equipment increase the curb weight and reduce the payload.
- You will find vehicle-specific weight information on the vehicle identification plate (→ page 405).

Roof load

Model	Maximum roof load
GLE 450 4MATIC	165 lb (75 kg)

Off-road driving

Fording depth

NOTE Damage caused by water when fording

Water can enter the engine compartment and vehicle interior in the following cases:

- The maximum permissible fording depth is exceeded when traveling through standing water.
 - A bow wave forms during fording.
 - Water accumulates when fording.
- ▶ Do not exceed the maximum permissible fording depth.
- ▶ Drive slowly through water.
- ▶ When driving through flowing water, be aware that the permissible fording depth is lower due to the accumulation of water.

The specified value indicates the maximum permissible fording depth for vehicles that are ready

to drive and for slow driving through standing water.

Observe the notes on off-road driving and fording (→ page 163).

Missing values were not available by the editorial deadline.

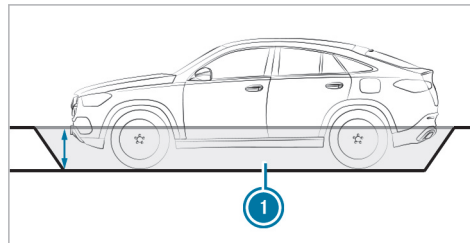

Fording depth

Model	1 Fording depth
Vehicles with steel suspension	19.7 in (50 cm)
Vehicles with AIRMATIC	
Raised level	19.7 in (50 cm)

Angle of approach/departure

The specified values are maximum values for vehicles that are in ready-to-drive condition.

Observe the notes on driving in mountainous terrain (→ page 163).

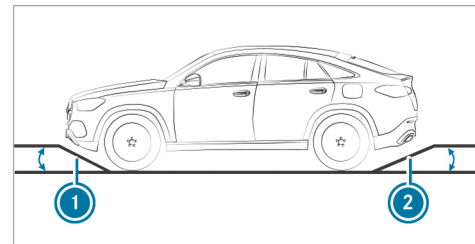

Angle of approach/departure

Model	① front	② rear
Vehicles with steel suspension*	21°	22°
Vehicles with AIR-MATIC*		
Normal level	21°	21°
Raised level	24°	24°

*Depending on the tire size

Maximum gradeability

The vehicle's gradeability depends on the weight distribution in the vehicle, the terrain conditions and the road surface conditions.

The specified value applies in the following cases:

- the vehicle is ready to drive
- the road surface conditions and thus traction are good

A gradeability of 100% corresponds to an incline of 45°.

Observe the notes on driving in mountainous terrain (→ page 163).

Gradeability

Model	Maximum gradeability
GLE 450 4MATIC	

Trailer hitch

General notes on the trailer hitch

Modifications to the cooling system may be necessary, depending on the vehicle model. Retrofitting a trailer hitch is permissible only if a trailer load is specified in your vehicle documents.

Further information can be obtained at a qualified specialist workshop.

Observe the information and notes on the trailer hitch (→ page 266).

Towing capacity

The tongue weight is not included in the towing capacity.

Towing capacity, braked

Model	Towing capacity, braked
GLE 450 4MATIC	7716 lbs (3500 kg)

Maximum tongue weight and load capacity

! **NOTE** Damage caused by the trailer coming loose

If the tongue weight used is too low, the trailer may come loose.

- ▶ The tongue weight must not be below 110.2 lbs (50 kg).
- ▶ Use a tongue weight that is as close as possible to the maximum permissible tongue weight.

! **NOTE** Damage caused by the bicycle rack coming loose

When using a bicycle rack, both the maximal tongue weight and the maximal load capacity should be observed.

▶ Do not exceed the permissible load capacity.

Tongue weight

Model	Maximum tongue weight
GLE 450 4MATIC	617 lbs (280 kg)

Load capacity

GLE 450 4MATIC	Maximum load capacity
When the bicycle rack is attached to the ball head	165.3 lbs (75 kg)
When the bicycle rack is attached to the ball head and additionally to the guide pins	220.5 lbs (100 kg)

Display messages

Introduction



Information about display messages



Display messages appear on the driver display.

Display messages with graphical symbols are simplified in the Operator's Manual and may differ from the symbols on the driver display. The driver display shows high-priority display messages in red. Certain display messages will be accompanied by a warning tone.

Please act in accordance with the display messages and follow the additional notes in the Operator's Manual.

For some display messages, symbols will also be shown:

-  Further information
-  Hide display message

You can select the respective symbol by swiping left or right on the left-hand Touch Control. Press  to display further information on the central display. Press  to hide the display message.

You can hide display messages to be acknowledged by pressing the back button  or with the left-hand Touch Control. The display messages will then be stored in the message memory.

Rectify the cause of a display message as quickly as possible.

High-priority display messages cannot be hidden. The driver display will show these display messages continuously until the cause of the display message has been rectified.



Calling up saved display messages

Driver display:



 **Service**

The **Message Memory: XX**message appears on the driver display.

 Scroll through the display messages by swiping upwards or downwards on the left-hand Touch Control.

 **To exit the display:** press the  back button.

Occupant safety



Display messages	Possible causes/consequences and ► Solutions
 <p data-bbox="144 384 413 436">Restraint System Malfunction Service Required</p>	<p data-bbox="476 294 1005 319">* The restraint system is malfunctioning (→ page 44).</p> <div data-bbox="500 335 1646 453" style="border: 1px solid gray; padding: 5px;"> <p data-bbox="506 342 1212 370">⚠ WARNING Risk of injury due to malfunctions in the restraint system</p> <p data-bbox="513 384 1578 408">Components in the restraint system may be activated unintentionally or not deploy as planned in an accident.</p> <p data-bbox="513 418 1474 443">► Have the restraint system checked and repaired immediately at a qualified specialist workshop.</p> </div>
 <p data-bbox="144 560 413 612">Front Left Malfunction Service Required (example)</p>	<p data-bbox="476 470 1005 495">* The restraint system is malfunctioning (→ page 44).</p> <div data-bbox="500 511 1646 629" style="border: 1px solid gray; padding: 5px;"> <p data-bbox="506 519 1212 547">⚠ WARNING Risk of injury due to malfunctions in the restraint system</p> <p data-bbox="513 560 1578 584">Components in the restraint system may be activated unintentionally or not deploy as planned in an accident.</p> <p data-bbox="513 594 1474 619">► Have the restraint system checked and repaired immediately at a qualified specialist workshop.</p> </div>
 <p data-bbox="144 736 395 816">Left Window Airbag Malfunction Service Required (example)</p>	<p data-bbox="476 646 1005 671">* The restraint system is malfunctioning (→ page 44).</p> <div data-bbox="500 687 1646 806" style="border: 1px solid gray; padding: 5px;"> <p data-bbox="506 695 1411 723">⚠ WARNING Risk of injury or fatal injury due to a malfunction in the window curtain airbag</p> <p data-bbox="513 736 1578 785">The window curtain airbag might be triggered unintentionally or might not be triggered at all in the event of an accident.</p> <p data-bbox="513 795 1530 820">► Have the window curtain airbag checked and repaired immediately at a qualified specialist workshop.</p> </div>



Display messages	Possible causes/consequences and ► Solutions
<p>Front Passenger Airbag Disabled See Operator's Manual</p>	<p>* The front passenger air bag has been disabled even though an adult or a person of adult build is on the front passenger seat. If additional forces are applied to the seat, the weight the system detects may be too low.</p> <div data-bbox="545 315 1690 523" style="border: 1px solid gray; padding: 5px;"> <p>▲ WARNING Risk of injury or fatal injury due to a disabled front passenger airbag</p> <p>If the front passenger airbag is disabled, the front passenger airbag will not be deployed in the event of an accident and cannot perform its intended protective function.</p> <p>A person in the front passenger seat could then, for example, come into contact with the vehicle's interior, especially if the person is sitting too close to the cockpit.</p> <p>► Make sure, both before and during the journey, that the status of the front passenger airbag is correct.</p> </div> <p>► Stop the vehicle immediately in accordance with the traffic conditions.</p> <p>► Make sure that no objects are trapped under the front passenger seat.</p> <p>► Check the status of automatic front passenger air bag shutoff (→ page 46).</p> <p>► If necessary, consult a qualified specialist workshop immediately.</p>
<p>Front Passenger Airbag Enabled See Operator's Manual</p>	<p>* The front passenger air bag will be enabled while the vehicle is in motion in the following situations:</p> <ul style="list-style-type: none"> • Even when a child, a small adult or an object weighing less than the system weight threshold is located on the front passenger seat • Even when the front passenger seat is not occupied <p>The system may detect objects or forces that are adding to the weight applied to the seat.</p>



Display messages	Possible causes/consequences and ► Solutions
	<p>▲ WARNING Risk of injury or death when using a child restraint system while the front passenger airbag is enabled</p> <p>If you secure a child in a child restraint system on the front passenger seat and the front passenger airbag is enabled, the front passenger airbag can deploy in the event of an accident.</p> <p>The child could be struck by the airbag.</p> <p>► Ensure, both before and during the journey, that the status of the front passenger airbag is correct.</p> <p>NEVER use a rearward facing child restraint on a seat protected by an ACTIVE AIRBAG in front of it, DEATH or SERIOUS INJURY to the CHILD can occur.</p> <ul style="list-style-type: none"> ► Stop the vehicle immediately in accordance with the traffic conditions. ► Make sure that no objects are trapped under the front passenger seat. ► Check the status of automatic front passenger air bag shutoff (→ page 46). ► If necessary, consult a qualified specialist workshop immediately.
<p>Occupant Presence Reminder Inoperative</p>	<p>* The occupant presence reminder is malfunctioning</p> <ul style="list-style-type: none"> ► Consult a qualified specialist workshop.

Display messages	Possible causes/consequences and ► Solutions
 <p data-bbox="195 342 436 391">Do Not Leave People or Animals in the Vehicle</p>	<ul style="list-style-type: none"> * The occupant presence reminder suspects that there are persons or animals in the rear of the vehicle. <ul style="list-style-type: none"> ► Do not leave any persons or animals behind when leaving the vehicle.



SmartKey





Display messages	Possible causes/consequences and ► Solutions
 <p data-bbox="195 638 399 664">Replace Key Battery</p>	<ul style="list-style-type: none"> * The key battery is discharged. <ul style="list-style-type: none"> ► Replace the battery (→ page 75).
 <p data-bbox="195 781 436 829">Key Not Detected (white display message)</p>	<ul style="list-style-type: none"> * The key is currently undetected. <ul style="list-style-type: none"> ► Change the location of the key in the vehicle. ► Try to start the vehicle. ► If the key is still not detected, place it in the slot for starting with the key (→ page 157). ► Start the vehicle.

Display messages	Possible causes/consequences and ► Solutions
 <p data-bbox="144 342 413 394">Key Not Detected (red display message)</p>	<p data-bbox="469 249 1350 275">* The key can no longer be detected during a journey and may no longer be in the vehicle.</p> <p data-bbox="493 285 1138 311">If the key is no longer in the vehicle and you switch off the vehicle:</p> <ul data-bbox="500 322 892 379" style="list-style-type: none"> <li data-bbox="500 322 874 348">• You can no longer start the vehicle. <li data-bbox="500 358 892 379">• You cannot centrally lock the vehicle. <p data-bbox="493 394 879 420">► Ensure that the key is in the vehicle.</p> <p data-bbox="493 446 981 472">If the key is in the vehicle and is still not detected:</p> <ul data-bbox="493 482 1258 544" style="list-style-type: none"> <li data-bbox="493 482 1215 508">► Stop the vehicle immediately in accordance with the traffic conditions. <li data-bbox="493 519 1258 544">► Place the key in the slot for starting the engine with the key (→ page 157). <p data-bbox="493 570 870 596">The key battery is weak or discharged.</p> <ul data-bbox="493 607 1082 664" style="list-style-type: none"> <li data-bbox="493 607 1082 632">► Check the battery using the indicator lamp (→ page 73). <li data-bbox="493 643 1027 664">► Replace the key battery, if necessary (→ page 75).
 <p data-bbox="144 772 413 798">Initializing Key Please Wait</p>	<p data-bbox="469 679 1055 705">* The vehicle is processing in order to teach in the new key.</p> <ul data-bbox="493 715 861 741" style="list-style-type: none"> <li data-bbox="493 715 861 741">► Wait until processing is complete.

Display messages	Possible causes/consequences and ► Solutions
 <p data-bbox="194 341 425 367">Don't Forget Your Key</p>	<p data-bbox="517 248 1598 274">* A warning tone also sounds. This message reminds you to take your key with you when you leave the vehicle.</p>
<p data-bbox="194 388 462 466">Place the Key in the Marked Space See Operator's Manual</p>	<p data-bbox="517 388 859 414">* Key detection is malfunctioning.</p> <ul data-bbox="545 419 1312 481" style="list-style-type: none"><li data-bbox="545 419 1016 445">► Change the location of the key in the vehicle.<li data-bbox="545 450 1312 481">► Place the key in the slot for starting the engine with the key (→ page 157).
 <p data-bbox="194 590 378 616">Obtain a New Key</p>	<p data-bbox="517 502 766 528">* Have the key replaced.</p> <ul data-bbox="545 533 970 559" style="list-style-type: none"><li data-bbox="545 533 970 559">► Consult a qualified specialist workshop.

Lights

Display messages	Possible causes/consequences and ► Solutions
 <p data-bbox="144 384 384 433">Malfunction See Operator's Manual</p>	<ul style="list-style-type: none"> <li data-bbox="469 293 864 319">* The exterior lighting is malfunctioning. <ul style="list-style-type: none"> <li data-bbox="495 324 912 350">► Consult a qualified specialist workshop. <li data-bbox="469 360 994 386">* Vehicles with a trailer hitch: a fuse may have blown. <ul style="list-style-type: none"> <li data-bbox="495 391 1092 417">► Stop the vehicle in accordance with the traffic conditions. <li data-bbox="495 422 1138 448">► Check the fuses and replace them if necessary (→ page 366).
 <p data-bbox="144 563 393 612">Automatic Driving Lights Inoperative</p>	<ul style="list-style-type: none"> <li data-bbox="469 472 1092 498">* The light sensor for automatic driving lights is malfunctioning. <ul style="list-style-type: none"> <li data-bbox="495 503 912 529">► Consult a qualified specialist workshop.
 <p data-bbox="144 732 417 781">Active Headlamps Inoperative</p>	<ul style="list-style-type: none"> <li data-bbox="469 641 898 667">* The active headlamps are malfunctioning. <ul style="list-style-type: none"> <li data-bbox="495 672 912 698">► Consult a qualified specialist workshop.

Display messages	Possible causes/consequences and ► Solutions
 <p data-bbox="199 342 413 366">Switch On Headlights</p>	<ul style="list-style-type: none"> <li data-bbox="519 252 1073 311">* You are driving without low-beam headlamps. <ul style="list-style-type: none"> <li data-bbox="543 283 1073 311">► Turn the light switch to the  or AUTO position.
 <p data-bbox="199 484 371 508">Switch Off Lights</p>	<ul style="list-style-type: none"> <li data-bbox="519 394 1147 453">* You are leaving the vehicle and the lights are still switched on. <ul style="list-style-type: none"> <li data-bbox="543 425 986 453">► Turn the light switch to the AUTO position.
<p data-bbox="199 536 473 581">MULTIBEAM LED Functions Limited</p>	<ul style="list-style-type: none"> <li data-bbox="519 536 1689 619">* The MULTIBEAM LED system is malfunctioning. The lighting system will continue to work, but without the functions of the MULTIBEAM LED system. <ul style="list-style-type: none"> <li data-bbox="543 591 962 619">► Consult a qualified specialist workshop.
 <p data-bbox="199 728 473 772">Dynamic Low Beam Inoperative</p>	<ul style="list-style-type: none"> <li data-bbox="519 638 1677 721">* The dynamic low beam is malfunctioning. The lighting system continues to function properly without the functions of the Dynamic Light System. <ul style="list-style-type: none"> <li data-bbox="543 693 962 721">► Consult a qualified specialist workshop.

Display messages	Possible causes/consequences and ► Solutions
 <p data-bbox="144 342 304 394">Check Left Low Beam (example)</p>	<ul style="list-style-type: none"> <li data-bbox="476 249 920 273">* The corresponding light source is defective. <ul style="list-style-type: none"> <li data-bbox="495 283 704 307">► Drive on carefully. <li data-bbox="495 318 1036 341">► Consult a qualified specialist workshop immediately. <li data-bbox="495 352 1637 401">① LED light sources: the display message for the corresponding light appears only when all the light-emitting diodes in the light are faulty.
<p data-bbox="144 422 408 495">Adaptive Highbeam Assist Currently Unavailable See Operator's Manual</p>	<ul style="list-style-type: none"> <li data-bbox="476 422 1581 539">* Adaptive Highbeam Assist is temporarily unavailable. The system limits have been reached (→ page 136). Once the cause of the problem is no longer present, the system will be available again. The Adaptive Highbeam Assist Now Available display message will appear. <ul style="list-style-type: none"> <li data-bbox="495 550 611 573">► Drive on <li data-bbox="495 584 1337 608">► Operate the high beam manually until Adaptive High Beam Assist is available again.
<p data-bbox="144 629 408 679">Adaptive Highbeam Assist Inoperative</p>	<ul style="list-style-type: none"> <li data-bbox="476 629 1332 816">* Adaptive Highbeam Assist is malfunctioning. <ul style="list-style-type: none"> <li data-bbox="495 660 611 684">► Drive on <li data-bbox="495 695 519 718">or <li data-bbox="495 729 1319 753">► Stop the vehicle in accordance with the traffic conditions and restart the vehicle. <li data-bbox="495 763 1332 787">► If the display message does not disappear: consult a qualified specialist workshop. <li data-bbox="495 797 957 821">► Until then, operate the high beam manually.

Display messages	Possible causes/consequences and ► Solutions
Hazard Warning Light Malfunction	<ul style="list-style-type: none"> * The hazard warning lamp switch is malfunctioning. <ul style="list-style-type: none"> ► Consult a qualified specialist workshop.

Drive system

Display messages	Possible causes/consequences and ► Solutions
Reduced Drive System Performance See Operator's Manual	<ul style="list-style-type: none"> * The drive system switches to emergency operation mode due to a malfunction. <ul style="list-style-type: none"> ► Drive on carefully. ► Consult a qualified specialist workshop.

Vehicle



Display messages	Possible causes/consequences and ► Solutions
	<ul style="list-style-type: none"> * The driver display is inoperative due to a failed software update. The display message will be shown every time the engine is started. <p>⚠ WARNING Risk of accident if the driver's display fails</p> <p>If the driver's display fails or malfunctions, you may not be aware of any functional limitations to safety-critical systems. This may affect the operating safety of the vehicle.</p>



Display messages	Possible causes/consequences and ► Solutions
	<p>► Park the vehicle safely as soon as possible and notify a qualified specialist workshop.</p> <p>If the operating safety of your vehicle is impaired, park the vehicle immediately and safely. Contact a qualified specialist workshop.</p> <p>If the driver display fails, you may not recognize e.g. function restrictions affecting systems relevant to safety or the speed display. The operating safety of the vehicle may be impaired (→ page 291).</p> <p>► Have the vehicle checked by a qualified specialist workshop immediately.</p>
<p>Cannot Start Vehicle See Operator's Manual</p>	<p>* The vehicle cannot be started.</p> <p>► Switch the vehicle off and then back on</p> <p>► If the display message still appears, consult a qualified specialist workshop.</p> <p>* Vehicles with 48 V on-board electrical system: the state of charge of the 48 V battery is too low. You can no longer start the vehicle.</p> <p>► Switch off electrical consumers that are not required.</p> <p>► Connect a suitable charger approved for Mercedes-Benz with sufficient charge output to the jump-start connection point of the 12 V battery (→ page 359). The 48 V battery is charged via the voltage converter in the vehicle.</p>
<p>Vehicle Ready to Drive Shutdown Occurs When Locked or Automatically in XX Mins</p>	<p>* You are about to leave the vehicle and the engine is running.</p> <p>The vehicle will switch off automatically in 20 minutes.</p> <p>► To prevent the vehicle from switching off automatically, acknowledge the message on the central display of the multimedia system.</p>

Display messages	Possible causes/consequences and ► Solutions
	<p>* You are in the vehicle. Park position P is engaged and the engine is running.</p> <p>After a certain holding time, this display message will appear on the driver display. The vehicle will then switch off automatically after a total of 20 minutes of holding time.</p> <p>► To prevent the vehicle from switching off automatically, acknowledge the message on the central display of the multimedia system.</p>
<p>Vehicle Ready to Drive Shutdown Occurs When Locked or After a Few Minutes</p>	<p>* You are leaving the vehicle in a ready-to-drive state.</p> <p>► Get out of the vehicle, secure it against rolling away and take the key with you.</p> <p>► If you do not leave the vehicle, switch off the electrical consumers, e.g. the seat heating. Otherwise, the 12 V battery may discharge and starting the engine may be possible only with the help of a second battery (jump start).</p>
 <p>Add Washer Fluid</p>	<p>* The washer fluid level in the washer fluid reservoir has dropped below the minimum.</p> <p>► Add washer fluid (→ page 337).</p>
<p>Windshield Wiper Malfunction</p>	<p>* The windshield wiper is malfunctioning.</p> <p>► Restart the vehicle.</p> <p>If the display message still appears:</p> <p>► Consult a qualified specialist workshop.</p>

432 Display messages and warning/indicator lamps

Display messages	Possible causes/consequences and ► Solutions
<p>Head-up Display Currently Unavailable See Operator's Manual</p>	<p>* The head-up display is temporarily unavailable. Possible causes:</p> <ul style="list-style-type: none">• Malfunctions in the power supply• Signal interference <p>► Stop in accordance with the traffic conditions and switch the vehicle off and on again.</p> <p>► If the display message still appears, consult a qualified specialist workshop.</p>
<p>Head-up Display Inoperative</p>	<p>* The head-up display has an internal error.</p> <p>► Consult a qualified specialist workshop.</p>
<p> Steering Malfunction Stop Immediately See Operator's Manual</p>	<p>* The steering is malfunctioning. Steering capability is significantly impaired.</p> <p>▲ WARNING Risk of accident if steering capability is impaired</p> <p>If the steering does not function as intended, the vehicle's operating safety is jeopardized.</p> <ul style="list-style-type: none">► Pull over and stop the vehicle safely as soon as possible, paying attention to road and traffic conditions. Do not continue driving under any circumstances.► Consult a qualified specialist workshop.

Display messages	Possible causes/consequences and ► Solutions
 <p data-bbox="195 342 449 418">Steering Malfunction Increased Physical Effort See Operator's Manual</p>	<p data-bbox="524 249 1018 275">* The power steering assistance is malfunctioning.</p> <div data-bbox="550 291 1698 443" style="border: 1px solid black; padding: 5px;"> <p data-bbox="559 301 1273 327">▲ WARNING Risk of an accident due to altered steering characteristics</p> <p data-bbox="559 337 1604 363">If the power assistance of the steering fails partially or completely, you will need to use more force to steer.</p> <ul style="list-style-type: none"> <li data-bbox="559 373 1036 399">▶ If safe steering is possible, drive on carefully. <li data-bbox="559 410 1175 436">▶ Visit or consult a qualified specialist workshop immediately. </div>
	<p data-bbox="524 459 722 485">* The hood is open.</p> <div data-bbox="550 501 1698 653" style="border: 1px solid black; padding: 5px;"> <p data-bbox="559 511 1240 537">▲ WARNING Risk of accident due to driving with the hood unlocked</p> <p data-bbox="559 548 962 573">The hood may open and block your view.</p> <ul style="list-style-type: none"> <li data-bbox="559 584 962 610">▶ Never release the hood when driving. <li data-bbox="559 620 1073 646">▶ Before every trip, ensure that the hood is locked. </div> <ul style="list-style-type: none"> <li data-bbox="543 672 1267 698">▶ Stop the vehicle immediately in accordance with the traffic conditions. <li data-bbox="543 708 735 734">▶ Close the hood.
	<p data-bbox="524 746 796 772">* At least one door is open.</p> <ul style="list-style-type: none"> <li data-bbox="543 783 735 809">▶ Close all doors.



Display messages	Possible causes/consequences and ► Solutions
	<p>* The tailgate is open.</p> <div style="border: 1px solid gray; padding: 5px; margin: 10px 0;"> <p>▲ DANGER Risk of exhaust gas poisoning</p> <p>Combustion engines emit poisonous exhaust gases such as carbon monoxide. Exhaust gases can enter the vehicle interior if the tailgate is open when the engine is running, especially if the vehicle is in motion.</p> <ul style="list-style-type: none"> ▶ Always switch off the engine before opening the tailgate. ▶ Never drive with the tailgate open. </div> <p>► Close the tailgate.</p>
 <p>2nd Seat Row, Center Not Locked</p>	<p>* The seat backrest of the corresponding seat is not engaged.</p> <p>► Fold the seat backrest back until it engages.</p>
 <p>Cannot Fold Forward 2nd Seat Row, Left Adjust Front Seat</p>	<p>* The left seat backrests on the second row of seats cannot be folded forward.</p> <p>► Adjust the corresponding front seat.</p>

Display messages	Possible causes/consequences and ► Solutions
 <p data-bbox="194 341 462 419">Cannot Fold Forward 2nd Seat Row, Right Adjust Front Seat</p>	<ul style="list-style-type: none"> <li data-bbox="517 248 1312 274">* The right seat backrests on the second row of seats cannot be folded forward. <ul style="list-style-type: none"> <li data-bbox="545 279 933 305">► Adjust the corresponding front seat.

Engine

Display messages	Possible causes/consequences and ► Solutions
<p data-bbox="194 572 471 678">To Switch Off Vehicle Press and Hold Start/Stop Button for at Least 3 Seconds or Press 3 Times</p>	<ul style="list-style-type: none"> <li data-bbox="517 572 1367 631">* You have pressed the start/stop button while the vehicle is in motion. <ul style="list-style-type: none"> <li data-bbox="545 606 1367 631">► Information about switching off the vehicle while it is being driven (→ page 156).
 <p data-bbox="194 792 462 844">Check Coolant Level See Operator's Manual</p>	<ul style="list-style-type: none"> <li data-bbox="517 699 813 725">* The coolant level is too low. <div data-bbox="545 740 1690 828" style="border: 1px solid gray; padding: 5px; margin-top: 5px;"> <p data-bbox="554 751 1081 777">! NOTE Engine damage due to insufficient coolant</p> <ul style="list-style-type: none"> <li data-bbox="563 792 1034 818">► Avoid long journeys with insufficient coolant. </div> <ul style="list-style-type: none"> <li data-bbox="545 844 850 870">► Add coolant (→ page 336).

Display messages	Possible causes/consequences and ► Solutions
 <p data-bbox="144 381 389 430">Coolant Stop Switch Off Vehicle</p>	<ul style="list-style-type: none"><li data-bbox="495 249 1258 275">► Have the engine cooling system checked at a qualified specialist workshop. <p data-bbox="476 291 713 317">* The coolant is too hot.</p> <ul style="list-style-type: none"><li data-bbox="495 322 1356 348">► Stop immediately in accordance with the traffic conditions and switch off the vehicle. <div data-bbox="500 373 1648 635" style="border: 1px solid gray; padding: 5px;"><p data-bbox="506 384 1021 410">▲ WARNING Risk of burns when opening the hood</p><p data-bbox="513 425 1604 477">If you open the hood in the event of an overheated engine or fire in the engine compartment, the following situations may occur:</p><ul style="list-style-type: none"><li data-bbox="519 487 962 513">• You may come into contact with hot gases.<li data-bbox="519 524 1208 550">• You may come into contact with other escaping hot operating fluids.<ul style="list-style-type: none"><li data-bbox="513 565 1097 591">► Before opening the hood, allow the engine to cool down.<li data-bbox="513 601 1474 627">► In the event of a fire in the engine compartment, keep the hood closed and call the fire service.</div> <ul style="list-style-type: none"><li data-bbox="495 653 907 679">► Wait until the engine has cooled down.<li data-bbox="495 689 1134 715">► Make sure that the air supply to the radiator is not obstructed.<li data-bbox="495 726 1622 772">► Avoiding high loads on the engine, drive to the nearest qualified specialist workshop. In doing so, ensure that the coolant temperature display remains below the red marking.

Display messages	Possible causes/consequences and ► Solutions
 <p>Fuel Reserve</p>	<ul style="list-style-type: none"> * The fuel supply has dropped into the reserve range. <ul style="list-style-type: none"> ► Refuel.
 <p>Fuel Filler Cap Open</p>	<ul style="list-style-type: none"> * The fuel filler cap is not closed correctly or the fuel system is leaking. <ul style="list-style-type: none"> ► Close the fuel filler cap. ► If the fuel filler cap was already properly closed: consult a qualified specialist workshop.

Transmission

Display messages	Possible causes/consequences and ► Solutions
Shift to P Only When Vehicle Is Stationary	<ul style="list-style-type: none"> * It is possible to select the park position P only if the vehicle is stationary. <ul style="list-style-type: none"> ► Depress the brake pedal to stop. ► Shift the transmission to park position P when the vehicle is stationary.
Depress Brake to Shift from P	<ul style="list-style-type: none"> * You have attempted to shift the transmission out of park position P and into another transmission position. <ul style="list-style-type: none"> ► Depress the brake pedal. ► Select transmission position D, R or neutral N.





Display messages	Possible causes/consequences and ► Solutions
<p>To Deselect P or N Depress Brake and Start Vehicle</p>	<p>* You have attempted to shift the transmission out of park position P or neutral N and into another transmission position.</p> <ul style="list-style-type: none"> ► Depress the brake pedal. ► Start the vehicle. ► Change the transmission position.
<p>Depress Brake to Shift to D or R</p>	<p>* You have attempted to select transmission position D or R.</p> <ul style="list-style-type: none"> ► Depress the brake pedal. ► Select transmission position D or R.
<p>Depress Brake to Shift to R</p>	<p>* You have attempted to select transmission position R.</p> <ul style="list-style-type: none"> ► Depress the brake pedal. ► Select transmission position R.
<p>Service Required Apply Parking Brake to Park</p>	<p>* A malfunction has occurred in the emergency power supply to park position P.</p> <ul style="list-style-type: none"> ► Consult a qualified specialist workshop. ► Until then, always select park position P manually before you switch off the vehicle. ► Before leaving the vehicle, apply the electric parking brake.
<p>Risk of Vehicle Rolling Away Driver's Door Open Position P Not Selected</p>	<p>* The driver's door is not fully closed and transmission position D, R or neutral N is selected. The vehicle may roll away.</p> <ul style="list-style-type: none"> ► Select park position P when switching off the vehicle.









Display messages	Possible causes/consequences and ► Solutions
Risk of Vehicle Rolling Away Apply Parking Brake When Parking	<ul style="list-style-type: none"> * The transmission is malfunctioning. Park position P cannot be selected. <ul style="list-style-type: none"> ► Park the vehicle safely. ► Use the electric parking brake to secure the vehicle against rolling away. ► On gradients, turn the front wheels so that the vehicle will roll towards the curb if it starts moving.
N Permanently Active Risk of Rolling Away	<ul style="list-style-type: none"> * Neutral N has been engaged while the vehicle is moving or while you are driving. <ul style="list-style-type: none"> ► Depress the brake pedal to stop. ► Shift the transmission to park position P when the vehicle is stationary. ► To continue driving, select transmission position D or R.
Reversing Not Possible Service Required	<ul style="list-style-type: none"> * The transmission is malfunctioning. It is not possible to select transmission position R. <ul style="list-style-type: none"> ► Consult a qualified specialist workshop.
Transmission Malfunction Stop	<ul style="list-style-type: none"> * The transmission is malfunctioning. The transmission shifts to neutral N automatically. <ul style="list-style-type: none"> ► Stop the vehicle immediately in accordance with the traffic conditions. ► Depress the brake pedal. ► Engage park position P. ► Consult a qualified specialist workshop.
Service Required Do Not Change Transmission Position	<ul style="list-style-type: none"> * The transmission is malfunctioning. It is no longer possible to change the transmission position.

440 Display messages and warning/indicator lamps

Display messages	Possible causes/consequences and ► Solutions
	<ul style="list-style-type: none">► If transmission position [D] is selected, consult a qualified specialist workshop and do not change the transmission position.► For all other transmission positions, park the vehicle safely.► Consult a qualified specialist workshop or breakdown service.
Stop Vehicle Leave Engine Running Wait Transmission Cooling	<p>* The transmission is overheating. Pulling away may be temporarily impaired or not possible.</p> <ul style="list-style-type: none">► Stop the vehicle immediately in accordance with the traffic conditions. Do not continue driving.► Leave the engine running.► Wait until the display message disappears before pulling away.
Auxiliary Battery Malfunction (white display message)	<p>* There is a malfunction in the auxiliary battery.</p> <ul style="list-style-type: none">► Consult a qualified specialist workshop.► Until then, always select park position [P] manually before you switch off the vehicle.► Before leaving the vehicle, apply the electric parking brake.
Auxiliary Battery Malfunction (red display message)	<p>* There is a malfunction in the auxiliary battery.</p> <ul style="list-style-type: none">► Consult a qualified specialist workshop.► Until then, always select park position [P] manually before you switch off the vehicle.► Before leaving the vehicle, apply the electric parking brake.



Brakes

Display messages	Possible causes/consequences and ► Solutions
<div data-bbox="203 295 360 378" data-label="Image"> </div> <div data-bbox="194 383 304 409" data-label="Text"> <p>(USA only)</p> </div> <div data-bbox="203 419 360 502" data-label="Image"> </div> <div data-bbox="194 507 341 533" data-label="Text"> <p>(Canada only)</p> </div> <div data-bbox="194 543 452 595" data-label="Text"> <p>Parking Brake See Operator's Manual</p> </div>	<ul style="list-style-type: none"> * The yellow  indicator lamp is lit. The electric parking brake is malfunctioning. <ul style="list-style-type: none"> ► To apply: <ul style="list-style-type: none"> ► Switch the vehicle off and then back on ► Apply the electric parking brake manually (→ page 188). If it is not possible to apply the electric parking brake: <ul style="list-style-type: none"> ► Consult a qualified specialist workshop. ► Where necessary, also secure the parked vehicle against rolling away. * The yellow  indicator lamp and the red  (USA only) or  (Canada only) indicator lamp are lit. The electric parking brake is malfunctioning. <ul style="list-style-type: none"> ► To release: <ul style="list-style-type: none"> ► Switch the vehicle off and then back on ► Release the electric parking brake manually (→ page 188). or <ul style="list-style-type: none"> ► Release the electric parking brake automatically (→ page 187). If it is still not possible to release the electric parking brake: <ul style="list-style-type: none"> ► Do not continue driving. Consult a qualified specialist workshop.

Display messages	Possible causes/consequences and ► Solutions
	<p>* The yellow  indicator lamp is lit and the red  (USA only) or  (Canada only) indicator lamp is flashing. The electric parking brake is malfunctioning.</p> <p>The electric parking brake could not be applied or released.</p> <ul style="list-style-type: none">► Switch the vehicle off and then back on <p>To apply:</p> <ul style="list-style-type: none">► Release and then apply the electric parking brake manually (→ page 188). <p>To release:</p> <ul style="list-style-type: none">► Apply and then release the electric parking brake manually. <p>If the electric parking brake cannot be applied or the red  (USA only) or  (Canada only) indicator lamp continues to flash:</p> <ul style="list-style-type: none">► Do not continue driving. Consult a qualified specialist workshop.► Where necessary, also secure the parked vehicle against rolling away. <p>* The yellow  indicator lamp is lit and the red  indicator lamp (USA only) or  indicator lamp (Canada only) flashes for approximately ten seconds after the electric parking brake has been applied or released. It then remains lit or goes out. The electric parking brake is malfunctioning.</p> <p>If the state of charge is too low:</p> <ul style="list-style-type: none">► Charge the 12 V battery (→ page 359).



Display messages	Possible causes/consequences and ► Solutions
	<p>To apply:</p> <ul style="list-style-type: none">► Switch off the vehicle. The electric parking brake will be applied automatically. <p>If you do not want the electric parking brake to be applied, e.g. at an automatic car wash or when the vehicle is being towed, leave the vehicle switched on. This does not include having the vehicle towed with the rear axle raised.</p> <p>If the electric parking brake is not applied automatically:</p> <ul style="list-style-type: none">► Switch the vehicle off and then back on► Release and then apply the electric parking brake manually (→ page 188). <p>If it is still not possible to apply the electric parking brake:</p> <ul style="list-style-type: none">► Consult a qualified specialist workshop.► Where necessary, also secure the parked vehicle against rolling away. <p>To release:</p> <ul style="list-style-type: none">► If the conditions for automatic release are fulfilled and the electric parking brake is not released automatically, release the electric parking brake manually (→ page 188). <p>If it is still not possible to release the electric parking brake:</p> <ul style="list-style-type: none">► Do not continue driving. Consult a qualified specialist workshop.

Display messages	Possible causes/consequences and ► Solutions
<div data-bbox="155 252 310 332" data-label="Image"> </div> <p data-bbox="155 342 255 366">(USA only)</p> <div data-bbox="155 379 310 458" data-label="Image"> </div> <p data-bbox="155 469 284 493">(Canada only)</p> <p data-bbox="149 503 371 527">Release Parking Brake</p>	<p data-bbox="473 249 1356 273">* The red PARK indicator lamp (USA only) or (P) indicator lamp (Canada only) is flashing.</p> <p data-bbox="495 283 1055 307">The electric parking brake is applied while you are driving:</p> <ul data-bbox="500 318 1493 380" style="list-style-type: none"> • A condition for automatic release of the electric parking brake has not been fulfilled (→ page 187). • You are performing emergency braking using the electric parking brake (→ page 188). <ul data-bbox="495 394 1234 456" style="list-style-type: none"> ► Check the conditions for automatic release of the electric parking brake. ► Release the electric parking brake manually.
<div data-bbox="155 553 310 632" data-label="Image"> </div> <p data-bbox="155 643 255 667">(USA only)</p> <div data-bbox="155 679 310 759" data-label="Image"> </div> <p data-bbox="155 769 284 793">(Canada only)</p> <p data-bbox="149 803 408 855">Switch on Vehicle to Release the Parking Brake</p>	<p data-bbox="473 556 1156 580">* The red PARK (USA only) or (P) (Canada only) indicator lamp is lit.</p> <p data-bbox="495 590 1332 614">You have attempted to release the electric parking brake with the vehicle switched off.</p> <ul data-bbox="495 624 741 648" style="list-style-type: none"> ► Switch on the vehicle.

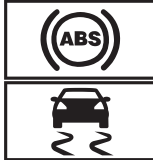

Display messages	Possible causes/consequences and ► Solutions
 <p>(USA only)</p>  <p>(Canada only)</p> <p>Check Brake Fluid Level</p>	<p>* There is insufficient brake fluid in the brake fluid reservoir.</p> <div style="border: 1px solid gray; padding: 5px; margin: 5px 0;"> <p>▲ WARNING Risk of an accident due to low brake fluid level</p> <p>If the brake fluid level is too low, the braking effect and the braking characteristics may be impaired.</p> <ul style="list-style-type: none"> ▶ Pull over and stop the vehicle safely as soon as possible, paying attention to road and traffic conditions. Do not continue driving under any circumstances. ▶ Consult a qualified specialist workshop. ▶ Do not add brake fluid. </div>
<p>Check Brake Pads See Operator's Manual</p>	<p>* The brakepads have reached the wear limit.</p> <ul style="list-style-type: none"> ▶ Consult a qualified specialist workshop.

Driving and driving safety systems

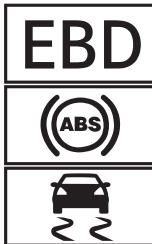

Display messages	Possible causes/consequences and ► Solutions
 <p data-bbox="144 469 408 519">Currently Unavailable See Operator's Manual</p>	<p data-bbox="476 294 912 319">* ABS and ESP® are temporarily unavailable.</p> <p data-bbox="495 329 1430 354">Other driving systems and driving safety systems (e.g. BAS) may also be temporarily unavailable.</p> <p data-bbox="495 364 1637 389">The brake system will continue to operate normally. Braking distance may increase in an emergency braking situation.</p> <div data-bbox="495 407 1644 676"><p data-bbox="506 415 1166 440">▲ WARNING Risk of skidding if ABS and ESP® are malfunctioning</p><p data-bbox="506 459 1378 484">The wheels may lock during braking and ESP® does not perform any vehicle stabilization.</p><p data-bbox="506 495 1600 544">The steerability and braking characteristics are heavily impaired and the braking distance may increase. In addition, other driving safety systems are switched off.</p><ul data-bbox="506 555 1581 667" style="list-style-type: none"><li data-bbox="506 555 1581 605">► Drive carefully on a suitable stretch of road, making slight steering movements at a speed above 19 mph (30 km/h).<li data-bbox="506 615 1581 667">► If the display message does not disappear, consult a qualified specialist workshop immediately. Drive carefully.</div>

Display messages	Possible causes/consequences and ► Solutions
 <p data-bbox="194 429 471 476">Inoperative See Operator's Manual</p>	<p data-bbox="526 253 1690 347">* ABS and ESP[®] are malfunctioning. Other driving systems and driving safety systems (e.g. BAS) may also be malfunctioning. The brake system will continue to operate normally. Braking distance may increase in an emergency braking situation.</p> <div data-bbox="554 362 1690 409" style="background-color: #f0f0f0; padding: 5px;"> <p data-bbox="563 372 1219 398">▲ WARNING Risk of skidding if ABS and ESP[®] are malfunctioning</p> </div> <p data-bbox="563 414 1690 502">The wheels may block during braking and ESP[®] does not perform any vehicle stabilization. The steerability and braking characteristics are heavily impaired and the braking distance may increase. In addition, other driving safety systems are switched off.</p> <ul data-bbox="563 507 1339 574" style="list-style-type: none"> <li data-bbox="563 512 776 538">► Drive on carefully. <li data-bbox="563 543 1339 574">► Have ABS and ESP[®] checked immediately at a qualified specialist workshop.
 <p data-bbox="194 694 462 740">Currently Unavailable See Operator's Manual</p>	<p data-bbox="526 600 1690 663">* ESP[®] is temporarily unavailable. Other driving systems and driving safety systems (e.g. BAS) may also be malfunctioning.</p> <div data-bbox="554 678 1690 720" style="background-color: #f0f0f0; padding: 5px;"> <p data-bbox="563 688 1118 714">▲ WARNING Risk of skidding if ESP is malfunctioning[®]</p> </div> <p data-bbox="563 730 1690 782">If ESP[®] is malfunctioning, ESP[®] cannot carry out vehicle stabilization. In addition, other driving safety systems are switched off.</p> <ul data-bbox="563 787 1617 844" style="list-style-type: none"> <li data-bbox="563 792 1617 844">► Drive carefully on a suitable stretch of road, making slight steering movements at a speed above 19 mph (30 km/h).

Display messages	Possible causes/consequences and ► Solutions
	<p>► If the display message does not disappear, consult a qualified specialist workshop immediately. Drive carefully.</p>
 <p>Inoperative See Operator's Manual</p>	<p>* ESP® is malfunctioning. Other driving systems and driving safety systems (e.g. BAS) may also be malfunctioning. The brake system will continue to operate normally. Braking distance may increase in an emergency braking situation.</p> <p>⚠ WARNING Risk of skidding if ESP® is malfunctioning</p> <p>If ESP® is malfunctioning, ESP® cannot carry out vehicle stabilization. In addition, other driving safety systems are switched off.</p> <p>► Drive on carefully. ► Have ESP® checked at a qualified specialist workshop.</p>



Display messages	Possible causes/consequences and ► Solutions
 <p data-bbox="194 512 471 564">Inoperative See Operator's Manual</p>	<p data-bbox="526 248 1404 310">* EBD, ABS and ESP® are malfunctioning. Other driving systems and driving safety systems (e.g. BAS) may also be malfunctioning.</p> <div data-bbox="545 326 1690 543" style="border: 1px solid gray; padding: 5px;"> <p data-bbox="554 336 1275 367">▲ WARNING Risk of skidding if EBD, ABS and ESP® are malfunctioning</p> <p data-bbox="563 378 1441 409">The wheels may block during braking and ESP® does not perform any vehicle stabilization.</p> <p data-bbox="563 414 1653 466">The steerability and braking characteristics are heavily impaired and the braking distance may increase. In addition, other driving safety systems are switched off.</p> <ul data-bbox="563 471 1367 533" style="list-style-type: none"> <li data-bbox="563 471 776 502">► Drive on carefully. <li data-bbox="563 507 1367 533">► Have the brake system checked immediately at a qualified specialist workshop. </div>
 <p data-bbox="194 673 231 704">Off</p>	<p data-bbox="526 585 1635 647">* The HOLD function is deactivated because the vehicle is slipping or a condition for activation is not fulfilled. ► Reactivate the HOLD function later or check the activation conditions for the HOLD function (→ page 197).</p>
 <p data-bbox="194 818 471 870">ATTENTION ASSIST: Take a Break!</p>	<p data-bbox="526 725 1552 782">* ATTENTION ASSIST has detected fatigue or an increasing lack of concentration on the part of the driver (→ page 198).</p> <ul data-bbox="545 787 840 813" style="list-style-type: none"> <li data-bbox="545 787 840 813">► If necessary, take a break.

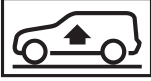
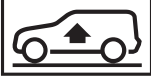

Display messages	Possible causes/consequences and ► Solutions
 <p>--- mph</p>	<ul style="list-style-type: none"> * Cruise control cannot be activated because not all activation conditions are fulfilled. <ul style="list-style-type: none"> ► Observe the activation conditions for cruise control (→ page 200).
<p>Cruise Control Inoperative</p>	<ul style="list-style-type: none"> * Cruise control is malfunctioning. <ul style="list-style-type: none"> ► Consult a qualified specialist workshop.
<p>Cruise Control Off</p>	<ul style="list-style-type: none"> * Cruise control has been deactivated. <p>If there is an additional warning tone, cruise control has been deactivated automatically (→ page 200).</p>
<p>Traffic Sign Assist Currently Unavailable See Operator's Manual</p>	<ul style="list-style-type: none"> * Traffic Sign Assist is temporarily unavailable. <p>Once the cause of the problem is no longer present, the system will be available again.</p> <ul style="list-style-type: none"> ► Continue driving in compliance with the traffic regulations.
<p>Traffic Sign Assist Inoperative</p>	<ul style="list-style-type: none"> * Traffic Sign Assist is malfunctioning. <ul style="list-style-type: none"> ► Continue driving in compliance with the traffic regulations. or ► Stop the vehicle in accordance with the traffic conditions and restart the vehicle. ► If the display message does not disappear: consult a qualified specialist workshop.

Display messages	Possible causes/consequences and ► Solutions
 <p data-bbox="195 342 473 391">Malfunction Do Not Exceed 50 mph</p>	<p data-bbox="524 249 1554 273">* AIRMATIC is functioning only to a limited extent. The vehicle's handling characteristics may be affected.</p> <div data-bbox="550 291 1696 438" style="border: 1px solid black; padding: 5px;"> <p data-bbox="561 301 1533 325">! NOTE The tires on the front axle or the fenders could be damaged by large steering movements</p> <ul style="list-style-type: none"> <li data-bbox="561 339 1341 363">► Avoid large steering movements while driving and listen for scraping sounds. <li data-bbox="561 373 1665 425">► If you hear scraping sounds, pull over and stop the vehicle in accordance with the traffic conditions, and set a higher vehicle level if possible. </div> <ul style="list-style-type: none"> <li data-bbox="543 453 1452 477">► Drive in a manner appropriate for the current level, but do not exceed 50 mph (80 km/h). <li data-bbox="543 487 966 511">► Consult a qualified specialist workshop.
 <p data-bbox="195 625 288 649">Lowering</p>	<p data-bbox="524 529 1055 553">* The vehicle level will lower for the following reasons:</p> <ul style="list-style-type: none"> <li data-bbox="550 567 1009 591">• You have selected a different drive program. <li data-bbox="550 601 925 625">• You have exceeded the speed limit. <li data-bbox="550 636 1147 659">• You have changed the vehicle level by pressing the button. <li data-bbox="550 670 1665 722">• Operation with a trailer or bicycle rack: if an electrical connection has been correctly made, you have exceeded the speed limit.
 <p data-bbox="195 832 260 856">Rising</p>	<p data-bbox="524 736 1079 760">* Your vehicle is adjusting to the level you have selected.</p>

Display messages	Possible causes/consequences and ► Solutions
 <p>Vehicle Rising Please Wait</p>	<ul style="list-style-type: none"> * The vehicle level is too low. The vehicle will be raised to the selected vehicle level. <ul style="list-style-type: none"> ► Wait until the display message disappears before pulling away.
 <p>Slow Down</p>	<ul style="list-style-type: none"> * You are driving too fast for the selected vehicle level. <ul style="list-style-type: none"> ► Drive more slowly and then select the desired vehicle level again. <p>You are driving too quickly with a trailer or the trailer hitch socket is being used, e.g. for a rear bicycle rack.</p> <ul style="list-style-type: none"> ► Observe the notes on trailer operation (→ page 266).
 <p>Compressor Is Cooling</p>	<ul style="list-style-type: none"> * Due to frequent level changes within a short space of time, the compressor first needs to cool down in order to set the selected vehicle level. <ul style="list-style-type: none"> ► Drive on in a manner appropriate for the current level. Make sure that there is sufficient ground clearance. When the compressor has cooled down, the vehicle will continue rising to the selected vehicle level.
<p>E-ACTIVE BODY CONTROL Function Limited See Operator's Manual</p>	<ul style="list-style-type: none"> * At least one main function of the E-ACTIVE BODY CONTROL system is malfunctioning. The system is outside the operating temperature range or the on-board electrical system voltage is too low. Once the cause of the problem is no longer present, the system will be available again.



Display messages	Possible causes/consequences and ► Solutions
	<p data-bbox="554 253 1690 315">! NOTE The vehicle's suspension and damping behavior is restricted. The vehicle body may tilt heavily to the side during cornering.</p> <ul style="list-style-type: none"> <li data-bbox="554 321 1690 352">► Drive on carefully. <li data-bbox="554 357 1690 388">► Reduce speed considerably before taking a bend. <li data-bbox="554 393 1690 424">► Avoid sudden steering movements. <ul style="list-style-type: none"> <li data-bbox="545 440 1690 471">► Drive on carefully. <li data-bbox="545 476 1690 507">► Reduce speed considerably before taking a bend. <li data-bbox="545 512 1690 543">► Avoid sudden steering movements.
Selected Level Not Available When Rear Fog Light On	<ul style="list-style-type: none"> <li data-bbox="517 559 1690 590">* You cannot select off-road level +3. <li data-bbox="545 595 1690 621">► Switch off the rear fog lamp.
 <p data-bbox="194 725 471 777">Malfunction Do Not Exceed 50 mph</p>	<ul style="list-style-type: none"> <li data-bbox="517 637 1690 694">* At least one main function of the E-ACTIVE BODY CONTROL system is malfunctioning. The system is deactivated. <p data-bbox="554 714 1690 777">! NOTE The vehicle's suspension and damping behavior has changed significantly, the vehicle body may tilt heavily to the side during cornering.</p> <ul style="list-style-type: none"> <li data-bbox="554 782 1690 813">► Reduce vehicle speed. Drive on carefully. <li data-bbox="554 818 1690 849">► Reduce the vehicle speed considerably before taking a curve.

Display messages	Possible causes/consequences and ► Solutions
	<p>► Avoid sudden steering movements.</p> <ul style="list-style-type: none"> ► Continue driving carefully and do not exceed 50 mph (80 km/h). ► If possible, stop in accordance with the traffic conditions and switch the vehicle off and on again. ► If the display message still appears, consult a qualified specialist workshop.
 <p>Malfunction Stop</p>	<p>* There is a serious malfunction affecting the hydraulics of the E-ACTIVE BODY CONTROL system. The system is deactivated.</p> <p>! NOTE The vehicle's driving characteristics have changed significantly.</p> <p>► Pull over and stop the vehicle safely as soon as possible in accordance with the traffic conditions. Do not continue driving under any circumstances.</p> <ul style="list-style-type: none"> ► Stop the vehicle immediately in accordance with the traffic conditions. Do not continue driving. ► Consult a qualified specialist workshop.
 <p>Inoperative</p>	<p>* DSR is malfunctioning.</p> <ul style="list-style-type: none"> ► Consult a qualified specialist workshop.

Display messages	Possible causes/consequences and ► Solutions
 <p data-bbox="194 336 434 367">Do Not Exceed 25 mph</p>	<ul style="list-style-type: none"> * The maximum speed of 25 mph (40 kmh) for DSR has been exceeded. <ul style="list-style-type: none"> ► Drive more slowly.
 <p data-bbox="194 476 434 507">Not in Curr. Drive Prog.</p>	<ul style="list-style-type: none"> * DSR is not available in the drive program currently selected. <ul style="list-style-type: none"> ► Change the drive program.



Driver assistance systems

Display messages	Possible causes/consequences and ► Solutions
 <p data-bbox="194 745 286 777">--- mph</p>	<ul style="list-style-type: none"> * Active Distance Assist DISTRONIC cannot be activated because not all activation conditions are fulfilled. <ul style="list-style-type: none"> ► Comply with the activation conditions of Active Distance Assist DISTRONIC (→ page 204).

Display messages	Possible causes/consequences and ► Solutions
 <p data-bbox="144 342 260 365">Suspended</p>	<p data-bbox="476 249 1646 301">* If you depress the accelerator pedal beyond the setting of Active Distance Assist DISTRONIC, the system will switch to passive mode (→ page 202).</p>
 <p data-bbox="144 484 181 507">Off</p>	<p data-bbox="476 391 1633 443">* Active Distance Assist DISTRONIC was deactivated. If a warning tone also sounds, Active Distance Assist DISTRONIC has deactivated automatically (→ page 204).</p>
<p data-bbox="144 533 421 609">Active Distance Assist Currently Unavailable See Operator's Manual</p>	<p data-bbox="476 533 1498 626">* Active Distance Assist DISTRONIC is temporarily unavailable. The ambient conditions are outside the system limits (→ page 202). As soon as the ambient conditions are within the system limits, the system will become available again.</p> <p data-bbox="495 637 704 659">► Drive on carefully.</p> <p data-bbox="495 674 519 697">or</p> <p data-bbox="495 707 1618 759">► If the display message does not disappear, stop the vehicle in accordance with the traffic conditions and restart the vehicle.</p>
<p data-bbox="144 774 426 826">Active Distance Assist Inoperative</p>	<p data-bbox="476 774 1360 831">* Active Distance Assist DISTRONIC and Active Emergency Stop Assist are malfunctioning. Other driving systems and driving safety systems may also be malfunctioning.</p> <p data-bbox="495 842 704 865">► Drive on carefully.</p>

Display messages	Possible causes/consequences and ► Solutions
	<p>or</p> <ul style="list-style-type: none"> ► Stop the vehicle in accordance with the traffic conditions and restart the vehicle. ► If the display message does not disappear: consult a qualified specialist workshop.
Active Distance Assist Now Available	<ul style="list-style-type: none"> * Active Distance Assist DISTRONIC is operational again. ► Switch on Active Distance Assist DISTRONIC (→ page 204).
Active Brake Assist Functions Currently Limited See Operator's Manual	<ul style="list-style-type: none"> * For vehicles with the Driving Assistance Package, the following functions may be temporarily unavailable or only partially available: <ul style="list-style-type: none"> • Active Brake Assist • Evasive Steering Assist (country-dependent) • Active Evasive Steering Assist (country-dependent) <p>The ambient conditions are outside the system limits (→ page 218).</p> <p>Vehicles without the Driving Assistance Package: Active Brake Assist is temporarily unavailable.</p> <ul style="list-style-type: none"> ► Drive on carefully. As soon as the ambient conditions are within the system limits, the system will become available again. <p>or</p> <ul style="list-style-type: none"> ► If the display message does not disappear, stop the vehicle in accordance with the traffic conditions and restart the vehicle.

Display messages	Possible causes/consequences and ► Solutions
<p>Active Brake Assist Functions Limited See Operator's Manual</p>	<p>* For vehicles with the Driving Assistance Package, the following functions may be temporarily unavailable or only partially available:</p> <ul style="list-style-type: none"> • Active Brake Assist • Evasive Steering Assist (country-dependent) • Active Evasive Steering Assist (country-dependent) <p>Vehicles without the Driving Assistance Package: Active Brake Assist is temporarily unavailable or only partially available.</p> <p>► Drive on carefully.</p> <p>or</p> <p>► Stop the vehicle in accordance with the traffic conditions and restart the vehicle.</p> <p>► If the display message does not disappear: consult a qualified specialist workshop.</p>
<p>Active Steering Assist Currently Unavailable See Operator's Manual</p>	<p>* Active Steering Assist is temporarily unavailable.</p> <p>The ambient conditions are outside the system limits (→ page 212).</p> <p>As soon as the ambient conditions are within the system limits, the system will become available again.</p> <p>► Drive on</p> <p>► Check the tire pressure if necessary.</p>
<p>Active Steering Assist Inoperative</p>	<p>* Active Steering Assist and Active Emergency Stop Assist are malfunctioning. Active Distance Assist DISTRONIC remains available.</p>

Display messages	Possible causes/consequences and ► Solutions
	<ul style="list-style-type: none"> ► Drive on or ► Stop the vehicle in accordance with the traffic conditions and restart the vehicle. ► If the display message does not disappear: consult a qualified specialist workshop.
	<ul style="list-style-type: none"> * Active Steering Assist has reached the system limits (→ page 212). You have not steered independently for a considerable period of time. ► Take over the steering and drive on in accordance with the traffic conditions.
<p>Active Steering Assist Currently Unavailable Due to Multiple Emergency Stops</p>	<ul style="list-style-type: none"> * Active Steering Assist is temporarily unavailable due to multiple emergency stops. ► Take over the steering and stop in accordance with the traffic conditions. ► Switch the vehicle off and then back on Active Steering Assist is available once more.
 <p>Initiating Emergency Stop</p>	<ul style="list-style-type: none"> * Your hands are not on the steering wheel. An emergency stop will be initiated (→ page 212). ► Make a deliberate steering movement. ► Accelerate or brake. <p>Information on canceling an emergency stop (→ page 214).</p>



Display messages	Possible causes/consequences and ► Solutions
<p>Active Stop & Go Assist Currently Unavailable See Operator's Manual</p>	<p>* Active Stop-and-Go Assist is temporarily unavailable. Active Distance Assist DISTRONIC and Active Steering Assist are still available. The ambient conditions are outside the system limits (→ page 209). As soon as the ambient conditions are within the system limits, the system will become available again.</p> <p>► Drive on</p>
<p>Active Stop & Go Assist Inoperative See Operator's Manual</p>	<p>* Active Stop-and-Go Assist is malfunctioning. Active Stop-and-Go Assist has been deactivated. Active Distance Assist DISTRONIC and Active Steering Assist are still available.</p> <p>► Drive on or</p> <p>► Stop the vehicle in accordance with the traffic conditions and restart the vehicle. ► If the display message does not disappear: consult a qualified specialist workshop.</p>
<p>Blind Spot Assist Currently Unavailable See Operator's Manual</p>	<p>* Blind Spot Assist is temporarily unavailable. The system limits have been reached (→ page 227). Once the cause of the problem is no longer present, the system will be available again.</p> <p>► Drive on or</p> <p>► If the display message does not disappear, stop the vehicle in accordance with the traffic conditions and restart the vehicle.</p>

Display messages	Possible causes/consequences and ► Solutions
Blind Spot Assist Inoperative	<ul style="list-style-type: none"> * Blind Spot Assist or the exit warning is malfunctioning. <ul style="list-style-type: none"> ► Drive on or ► Stop the vehicle in accordance with the traffic conditions and restart the vehicle. ► If the display message does not disappear: consult a qualified specialist workshop.
Blind Spot Assist Not Available When Towing Trailer See Operator's Manual	<ul style="list-style-type: none"> * When you establish the electrical connection to the trailer, Blind Spot Assist will be unavailable. <ul style="list-style-type: none"> ► Press the left-hand Touch Control and acknowledge the display message.
Active Blind Spot Assist Currently Unavailable See Operator's Manual	<ul style="list-style-type: none"> * Active Blind Spot Assist is temporarily unavailable. The system limits have been reached (→ page 227). Once the cause of the problem is no longer present, the system will be available again. <ul style="list-style-type: none"> ► Drive on or ► If the display message does not disappear, stop the vehicle in accordance with the traffic conditions and restart the vehicle.
Active Blind Spot Assist Inoperative	<ul style="list-style-type: none"> * Active Blind Spot Assist or the exit warning is malfunctioning. <ul style="list-style-type: none"> ► Drive on or

462 Display messages and warning/indicator lamps

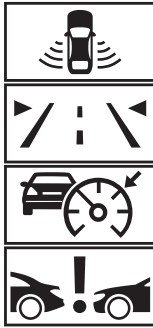
Display messages	Possible causes/consequences and ► Solutions
	<ul style="list-style-type: none"> ► Stop the vehicle in accordance with the traffic conditions and restart the vehicle. ► If the display message does not disappear: consult a qualified specialist workshop.
<p>Active Blind Spot Assist Not Available When Towing Trailer See Operator's Manual</p>	<p>* When you establish the electrical connection to the trailer, Active Blind Spot Assist will be unavailable.</p> <ul style="list-style-type: none"> ► Press the left-hand Touch Control and acknowledge the display message.
<p>Active Lane Keeping Assist Currently Unavailable See Operator's Manual</p>	<p>* Active Lane Keeping Assist is temporarily unavailable. The ambient conditions are outside the system limits (→ page 230). As soon as the ambient conditions are within the system limits, the system will become available again.</p> <ul style="list-style-type: none"> ► Drive on
<p>Active Lane Keeping Assist Inoperative</p>	<p>* Active Lane Keeping Assist is malfunctioning. The Active Emergency Stop Assist is also malfunctioning (country-dependent).</p> <ul style="list-style-type: none"> ► Drive on <p>or</p> <ul style="list-style-type: none"> ► Stop the vehicle in accordance with the traffic conditions and restart the vehicle. ► If the display message does not disappear: consult a qualified specialist workshop.
<p>Active Lane Keeping Assist Limited Range of Functions See Operator's Manual</p>	<p>* Active Lane Keeping Assist is available but restricted.</p> <ul style="list-style-type: none"> ► Drive on <p>or</p>

Display messages	Possible causes/consequences and ► Solutions
 <p data-bbox="194 663 443 714">Temporarily Unavailable Sensors Dirty</p>	<ul style="list-style-type: none"> ► Stop the vehicle in accordance with the traffic conditions and restart the vehicle. ► If the display message does not disappear: consult a qualified specialist workshop. <p data-bbox="526 315 1413 341">* Front and corner radar sensors (hereafter "sensors") are malfunctioning. Possible causes:</p> <ul style="list-style-type: none"> • The sensors are dirty • Heavy rain or snow • Extended country driving without other traffic, e.g. in the desert <p data-bbox="545 461 1690 512">Driving systems and driving safety systems may be malfunctioning or temporarily unavailable. The brake system, steering and drive system will continue to function normally.</p> <ul style="list-style-type: none"> ► Drive on carefully. <p data-bbox="545 574 1690 626">Once the causes of the problem are no longer present, the driving systems and driving safety systems will be available again and the corresponding symbols will be switched off.</p> <p data-bbox="545 637 960 663">If the display message does not disappear:</p> <ul style="list-style-type: none"> ► Stop the vehicle in accordance with the traffic conditions. ► Clean all sensor covers from the outside (→ page 191). ► Restart the vehicle.

Display messages	Possible causes/consequences and ► Solutions
 <p data-bbox="144 767 421 816">Camera View Reduced See Operator's Manual</p>	<p data-bbox="476 249 1151 272">* The view of the multifunction camera is restricted. Possible causes:</p> <ul data-bbox="500 285 1626 407" style="list-style-type: none"> <li data-bbox="500 285 1215 308">• Dirt on the windshield in the field of vision of the multifunction camera <li data-bbox="500 319 759 341">• Heavy rain, snow or fog <li data-bbox="500 352 1626 407">• Mist on the inside or outside of the windshield: in certain weather conditions, mist can form on the inside or outside of the windshield during cold times of year in particular. <p data-bbox="495 420 1631 475">  This mist on the windshield will be removed automatically within a short time with the aid of a heater. The restriction is temporary. </p> <p data-bbox="495 482 1644 537">Driving systems and driving safety systems may be malfunctioning or temporarily unavailable. The brake system, steering and drive system will continue to function normally.</p> <ul data-bbox="495 544 1143 643" style="list-style-type: none"> <li data-bbox="495 544 704 567">► Drive on carefully. <li data-bbox="495 578 1110 600">► To remove mist from the outside, wipe once (→ page 139). <li data-bbox="495 611 1143 643">► To remove the mist from the inside, press  (→ page 150). <p data-bbox="495 666 1644 721">Once the causes of the problem are no longer present, the driving systems and driving safety systems will be available again and the corresponding symbols will be switched off.</p> <p data-bbox="495 728 1354 751">If the display message does not disappear even after a driving time of about 15 minutes:</p> <ul data-bbox="495 758 1411 856" style="list-style-type: none"> <li data-bbox="495 758 1092 781">► Stop the vehicle in accordance with the traffic conditions. <li data-bbox="495 791 1411 824">► Clean the windshield, especially in the position of the multifunction camera (→ page 191). <li data-bbox="495 831 718 854">► Restart the vehicle.

Display messages	Possible causes/consequences and ► Solutions
 <p data-bbox="194 512 443 564">Functions Limited When Towing Trailer</p>	<ul style="list-style-type: none"> * When the trailer socket is occupied, some driving systems will be available only to a limited extent. <ul style="list-style-type: none"> ► Drive carefully if you are towing a trailer or have the bicycle rack mounted.
<p data-bbox="194 585 462 637">PRE-SAFE Inoperative See Operator's Manual</p>	<ul style="list-style-type: none"> * The PRE-SAFE® functions are malfunctioning. <ul style="list-style-type: none"> ► Consult a qualified specialist workshop.
<p data-bbox="194 663 462 740">PRE-SAFE Pulse Side Inoperative See Operator's Manual</p>	<ul style="list-style-type: none"> * The PRE-SAFE® Impulse Side system is malfunctioning or inoperative after having already been triggered. <ul style="list-style-type: none"> ► Consult a qualified specialist workshop.



Parking assistance systems



Display messages	Possible causes/consequences and ► Solutions
<p>PARKTRONIC Inoperative See Operator's Manual</p>	<p>* Parking Assist PARKTRONIC is malfunctioning. Once the cause of the problem is no longer present, the system will be available again.</p> <ul style="list-style-type: none"> ► Continue driving while paying attention to the vehicle's surroundings. <p>or</p> <ul style="list-style-type: none"> ► Stop the vehicle in accordance with the traffic conditions and restart the vehicle. ► If the display message still appears, consult a qualified specialist workshop.
<p>Active Parking Assist and PARKTRONIC Inoperative See Operator's Manual</p>	<p>* Active Parking Assist and Parking Assist PARKTRONIC are malfunctioning. Once the cause of the problem is no longer present, the system will be available again.</p> <ul style="list-style-type: none"> ► Continue driving while paying attention to the vehicle's surroundings. <p>or</p> <ul style="list-style-type: none"> ► Stop the vehicle in accordance with the traffic conditions and restart the vehicle. ► If the display message still appears, consult a qualified specialist workshop.



Mercedes-Benz emergency call system

Display messages	Possible causes/consequences and ► Solutions
 <p data-bbox="194 383 314 409">Inoperative</p>	<ul style="list-style-type: none"> <li data-bbox="526 295 1681 347">* The Mercedes-Benz emergency call system is malfunctioning. The Mercedes me connect system is also malfunctioning. <ul style="list-style-type: none"> <li data-bbox="545 352 970 378">► Consult a qualified specialist workshop.

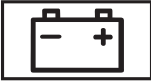
Battery

Display messages	Possible causes/consequences and ► Solutions
 <p data-bbox="194 652 452 709">12 V On-board Electrical System Service Required</p>	<ul style="list-style-type: none"> <li data-bbox="526 564 1090 621">* The 12 V on-board electrical system is malfunctioning. <ul style="list-style-type: none"> <li data-bbox="545 595 1090 621">► Consult a qualified specialist workshop immediately.
 <p data-bbox="194 823 443 875">Stop Vehicle See Operator's Manual</p>	<ul style="list-style-type: none"> <li data-bbox="526 730 1312 756">* The 12 V battery is no longer being charged and the state of charge is too low. <div data-bbox="545 771 1690 859" style="border: 1px solid gray; padding: 5px; margin-top: 5px;"> <p data-bbox="554 782 1127 808">! NOTE Possible engine damage if you continue driving</p> <ul style="list-style-type: none"> <li data-bbox="563 823 1090 849">► Do not continue driving under any circumstances. </div>

Display messages	Possible causes/consequences and ► Solutions
	<p>► Consult a qualified specialist workshop.</p> <ul style="list-style-type: none"> ► Stop the vehicle immediately in accordance with the traffic conditions. Do not continue driving. ► Switch off the vehicle. ► Consult a qualified specialist workshop.
 <p>Switch on vehicle to charge the 12 V battery</p>	<p>* The vehicle is off and the state of charge of the 12 V battery is too low.</p> <ul style="list-style-type: none"> ► Switch off electrical consumers that are not required. ► Drive for 30–60 mins. <p>or</p> <ul style="list-style-type: none"> ► Charge the 12 V battery when stationary (→ page 359).
 <p>Stop Vehicle To Charge the 12 V Battery Do Not Switch Off Vehicle</p>	<p>* The state of charge of the 12 V battery is too low.</p> <ul style="list-style-type: none"> ► Stop the vehicle immediately in accordance with the traffic conditions. Do not continue driving. ► Leave the vehicle running ► If the display message disappears: drive on. ► If the display message does not disappear: consult a qualified specialist workshop.



Display messages	Possible causes/consequences and ► Solutions
 <p data-bbox="194 341 452 419">Battery Overheated Stop! Everyone Get Out! Out- doors if Possible</p>	<ul style="list-style-type: none"> * The 48 V battery is overheating. There is a risk of fire. <ul style="list-style-type: none"> ► Stop the vehicle immediately in accordance with the traffic conditions. ► If possible, stop the vehicle in the open air and ensure that all vehicle occupants get out. ⓘ Supporting vehicle functions may activate automatically, e.g. air-recirculation mode as part of climate control. ► Do not continue driving. ► If smoke is present, leave the danger zone and call the fire service immediately. ► Consult a qualified specialist workshop even if there are no external signs of a fire.
 <p data-bbox="194 595 443 647">48 V Battery See Opera- tor's Manual</p>	<ul style="list-style-type: none"> * The 48 V on-board electrical system has function restrictions. Comfort functions, such as the air conditioning system, may be available only to a limited extent. It is possible to drive on. <ul style="list-style-type: none"> ► If the display message remains active permanently, consult a qualified specialist workshop immediately.
 <p data-bbox="194 761 462 813">Please Wait Charging 48 V Battery...</p>	<ul style="list-style-type: none"> * The 48 V battery is discharged. You have switched on the vehicle while the 12 V battery was being charged with a suitable charger or while another vehicle was providing starting assistance. The discharged 48 V battery is charged automatically via the voltage converter. After a few minutes, the Starting Possible Again display message will be shown on the driver's display. <ul style="list-style-type: none"> ► Start the vehicle.



470 Display messages and warning/indicator lamps



Display messages	Possible causes/consequences and ► Solutions
	<ul style="list-style-type: none">► Drive the vehicle for a while to charge the 12 V battery and the 48 V battery after disconnecting the charger from the vehicle. <p>If the Starting Possible Again display message does not appear after a few minutes:</p> <ul style="list-style-type: none">► Try to start the vehicle.► If the vehicle does not start, consult a qualified specialist workshop.
Starting Possible Again	<ul style="list-style-type: none">* The 48 V battery has been charged automatically via the voltage converter.► Start the vehicle and drive for a while to charge the 12 V battery and the 48 V battery.

Tire pressure monitor

Display messages	Possible causes/consequences and ► Solutions
Tire Pressure Monitor Currently Unavailable	<ul style="list-style-type: none">* There is interference from a powerful radio signal source. As a result, no signals from the tire pressure sensors are being received. The tire pressure monitoring system is temporarily unavailable. The tire pressure monitoring system will restart automatically as soon as the cause has been rectified.► Drive on
Tire Pressure Monitor Inoperative	<ul style="list-style-type: none">* The tire pressure monitoring system is malfunctioning.

Display messages	Possible causes/consequences and ► Solutions
	<p>▲ WARNING There is a risk of an accident if the tire pressure monitoring system is malfunctioning</p> <p>The tire pressure monitoring system cannot issue a warning if there is pressure loss in one or more of the tires. Tires with insufficient tire pressure may impair the driving characteristics as well as steering and braking.</p> <p>► Have the tire pressure monitoring system checked at a qualified specialist workshop.</p>
<p>Tire Pressure Monitor Inoperative Tire Pressure Sensors Missing</p>	<p>* The wheels installed do not have suitable tire pressure sensors. The tire pressure monitoring system is deactivated.</p> <p>► Install wheels with suitable tire pressure sensors.</p>
 <p>Wheel Sensor(s) Missing</p>	<p>* There is no signal from the tire pressure sensor in at least one wheel. No pressure value is displayed for the affected tire.</p> <p>► Have the faulty tire pressure sensor replaced at a qualified specialist workshop.</p>
 <p>Check Tires</p>	<p>* The tire pressure in one or more tires has dropped significantly. The wheel position is displayed. A warning tone also sounds.</p> <p>▲ WARNING Risk of an accident due to insufficient tire pressure</p> <ul style="list-style-type: none"> • The tires can burst. • The tires can wear excessively and/or unevenly.



Display messages	Possible causes/consequences and ► Solutions
	<ul style="list-style-type: none"> • The driving characteristics as well as the steering and braking may be greatly impaired. You could then lose control of the vehicle. ► Observe the recommended tire pressures. ► Adjust the tire pressure if necessary. <p>► Stop the vehicle in accordance with the traffic conditions.</p> <p>► Check the tire pressure (→ page 371) and the tires.</p>
 <p>Please Correct Tire Pressure</p>	<p>* The tire pressure is too low in at least one of the tires, or the difference in tire pressure between the individual wheels is too great.</p> <ul style="list-style-type: none"> ► Check the tire pressure and add air, if necessary. ► When the tire pressure is correct, restart the tire pressure monitor (→ page 376).
 <p>Warning Tire Malfunction</p>	<p>* The pressure in one or more tires has dropped suddenly. The wheel position is displayed.</p> <p>⚠ WARNING Risk of an accident from driving with a flat tire</p> <ul style="list-style-type: none"> • The tires can overheat and be damaged. • The driving characteristics as well as the steering and braking characteristics may be greatly impaired. <p>You could then lose control of the vehicle.</p>



Display messages	Possible causes/consequences and ► Solutions
	<ul style="list-style-type: none"> ► Do not drive with a flat tire. ► Do not exceed the maximum permissible driving distance in emergency mode and the maximum permissible speed with a flat MOExtended tire. ► Observe the notes on flat tires. <p>Notes on flat tire (→ page 350).</p> <ul style="list-style-type: none"> ► Stop the vehicle in accordance with the traffic conditions. ► Check the tires.
 <p data-bbox="194 606 369 626">Tires Overheated</p>	<p data-bbox="526 512 1672 564">* At least one tire is overheating. The affected tires are displayed in red. At temperatures close to the limit value, the tires are displayed in yellow.</p> <div data-bbox="545 585 1690 621" style="background-color: #cccccc; padding: 5px;"> <p data-bbox="554 590 1228 616">▲ WARNING Risk of an accident from driving with overheated tires</p> </div> <p data-bbox="554 626 831 652">Overheated tires can burst.</p> <ul style="list-style-type: none"> ► Reduce speed so that the tires cool down.
 <p data-bbox="194 808 351 828">Reduce Speed</p>	<p data-bbox="526 714 1672 766">* At least one tire is overheating. The affected tires are displayed in red. At temperatures close to the limit value, the tires are displayed in yellow.</p> <div data-bbox="545 787 1690 823" style="background-color: #cccccc; padding: 5px;"> <p data-bbox="554 792 1228 818">▲ WARNING Risk of an accident from driving with overheated tires</p> </div> <p data-bbox="554 828 831 854">Overheated tires can burst.</p>

474 Display messages and warning/indicator lamps

Display messages	Possible causes/consequences and ► Solutions
	<p>► Reduce speed so that the tires cool down.</p>

Engine oil

Display messages	Possible causes/consequences and ► Solutions
 <p data-bbox="144 529 408 605">Check Engine Oil Level At Next Refueling (Add 1 Quart)</p>	<p data-bbox="476 439 1023 459">* The engine oil level has dropped to the minimum level.</p> <div data-bbox="500 477 1646 563"><p data-bbox="506 487 1203 511">! NOTE Engine damage caused by driving with insufficient engine oil</p><p data-bbox="506 529 1005 553">► Avoid long journeys with insufficient engine oil.</p></div> <p data-bbox="495 581 1190 605">► When next refueling, add 1.1 US qt (1 l) of engine oil (→ page 335).</p> <p data-bbox="495 625 833 646">Notes on engine oil (→ page 410).</p>
 <p data-bbox="144 760 421 801">Engine Oil Level Reduce Oil Level</p>	<p data-bbox="476 670 796 691">* The engine oil level is too high.</p> <div data-bbox="500 708 1646 794"><p data-bbox="506 718 1160 742">! NOTE Engine damage caused by driving with excess engine oil</p><p data-bbox="506 760 962 784">► Avoid long journeys with excess engine oil.</p></div> <p data-bbox="495 812 1406 836">► Consult a qualified specialist workshop immediately and have the engine oil level reduced.</p>

Display messages	Possible causes/consequences and ► Solutions
 <p data-bbox="194 341 415 393">Engine Oil Level Stop Switch Off Vehicle</p>	<p data-bbox="526 248 840 274">* The engine oil level is too low.</p> <div data-bbox="545 295 1690 378" style="border: 1px solid gray; padding: 5px;"> <p data-bbox="554 300 1256 326">! NOTE Engine damage caused by driving with insufficient engine oil</p> <p data-bbox="554 336 1062 367">► Avoid long journeys with insufficient engine oil.</p> </div> <ul data-bbox="545 388 1506 523" style="list-style-type: none"> <li data-bbox="545 388 1506 419">► Stop the vehicle immediately in accordance with the traffic conditions. Do not continue driving. <li data-bbox="545 424 803 450">► Switch off the vehicle. <li data-bbox="545 455 1044 486">► Add 1.1 US qt (1 l) of engine oil (→ page 335). <li data-bbox="545 492 840 523">► Check the engine oil level. <p data-bbox="545 538 887 564">Notes on engine oil (→ page 410).</p>
 <p data-bbox="194 673 452 725">Engine Oil Pressure Stop Switch Off Vehicle</p>	<p data-bbox="526 580 803 606">* The oil pressure is too low.</p> <div data-bbox="545 626 1690 709" style="border: 1px solid gray; padding: 5px;"> <p data-bbox="554 631 1275 657">! NOTE Engine damage caused by driving with insufficient oil pressure</p> <p data-bbox="554 668 1007 699">► Avoid driving with insufficient oil pressure.</p> </div> <ul data-bbox="545 720 1506 818" style="list-style-type: none"> <li data-bbox="545 720 1506 751">► Stop the vehicle immediately in accordance with the traffic conditions. Do not continue driving. <li data-bbox="545 756 803 782">► Switch off the vehicle. <li data-bbox="545 787 970 818">► Consult a qualified specialist workshop.

Display messages	Possible causes/consequences and ► Solutions
 <p>Engine Oil Level Cannot Be Measured</p>	<p>* The electrical connection to the oil level sensor has been interrupted or the oil level sensor is faulty.</p> <p>► Consult a qualified specialist workshop.</p>

Warning and indicator lamps

Overview of indicator and warning lamps

Some systems will perform a self-test when the vehicle is switched on. Some indicator and warning lamps may briefly light up or flash. This behavior is non-critical. These indicator and warning lamps indicate a malfunction only if they light up or flash after the vehicle has been started or during a journey.

The indicator and warning lamps are located in the highlighted display sections.

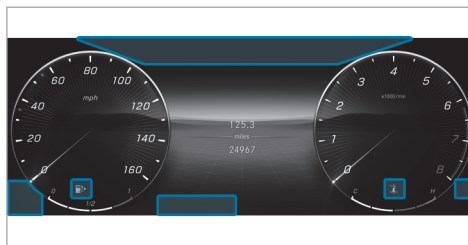

Driver display



Indicator and warning lamps

Occupant safety



 Restraint system (→ page 478)

-  Seat belt (→ page 478)
-  Occupant presence reminder (white) (→ page 478)
-  Occupant presence reminder (yellow) (→ page 478)

Drive system





 Reduced power (→ page 480)

Vehicle







-  Power steering (yellow) (→ page 480)
-  Power steering (red) (→ page 480)

Engine

 Coolant temperature (→ page 481)









-  Engine diagnostics (→ page 481)
-  Vehicles with gasoline engine: engine operating temperature (→ page 481)
-  Electrical malfunction (→ page 481)
-  Reserve fuel with fuel filler flap location indicator (→ page 481)

Brakes

-  Electric parking brake (yellow) (→ page 485)
-  USA: electric parking brake (red) (→ page 485)
-  Canada: electric parking brake (red) (→ page 485)
-  USA: Recuperative Brake System (→ page 485)
-  Canada: brakes (yellow) (→ page 485)
-  USA: brakes (red) (→ page 485)
-  Canada: brakes (red) (→ page 485)

Driving and driving safety systems

-  ABS (→ page 488)

-  ESP® (→ page 488)
-  ESP® OFF (→ page 488)
-  ATTENTION ASSIST (→ page 488)
-  Traffic Sign Assist (→ page 488)
-  Distance warning (→ page 488)
-  Active Brake Assist (→ page 488)
-  Active Brake Assist (→ page 488)
-  AIRMATIC (→ page 488)
-  E-ACTIVE BODY CONTROL (→ page 488)



Mercedes-Benz emergency call system



-  Mercedes-Benz emergency call system (→ page 493)

Tire pressure monitor



-  Tire pressure monitor (→ page 493)

Exterior lighting



-  Parking lamps (→ page 133)
-  Low beam (→ page 133)
-  High beam (→ page 134)



-  Turn signal lights (→ page 134)
-  Rear fog light (→ page 133)

Symbols on the central display

-  Drive Away Assist (→ page 260)
-  Cross Traffic Alert (→ page 261)
-  Close-range braking (→ page 262)

Occupant safety



Warning/indicator lamp	Possible causes/consequences and ► Solutions
 <p data-bbox="144 384 395 433">Restraint system warning lamp</p>	<p data-bbox="462 294 1123 342">* The restraint system red warning lamp is lit while the vehicle is on. The restraint system is malfunctioning (→ page 44).</p> <div data-bbox="482 363 1644 477" style="border: 1px solid gray; padding: 5px;"> <p data-bbox="491 368 1193 396">▲ WARNING Risk of injury due to malfunctions in the restraint system</p> <p data-bbox="491 410 1559 436">Components in the restraint system may be activated unintentionally or not deploy as planned in an accident.</p> <p data-bbox="491 443 1456 469">► Have the restraint system checked and repaired immediately at a qualified specialist workshop.</p> </div> <ul data-bbox="476 495 1020 588" style="list-style-type: none"> <li data-bbox="476 495 687 521">► Drive on carefully. <li data-bbox="476 529 907 555">► Note the messages on the driver display. <li data-bbox="476 563 1020 588">► Consult a qualified specialist workshop immediately.
 <p data-bbox="144 700 371 749">Seat belt warning lamp flashes</p>	<p data-bbox="462 610 1389 658">* The red seat belt warning lamp flashes and an intermittent warning tone sounds. The driver or front passenger has not fastened his/her seat belt while the vehicle is in motion.</p> <ul data-bbox="476 667 1009 752" style="list-style-type: none"> <li data-bbox="476 667 857 693">► Fasten your seat belt (→ page 44). <li data-bbox="476 695 931 721">There are objects on the front passenger seat. <li data-bbox="476 729 1009 752">► Remove the objects from the front passenger seat.

Warning/indicator lamp	Possible causes/consequences and ► Solutions
 <p data-bbox="194 341 425 393">Seat belt warning lamp lights up</p>	<p data-bbox="508 248 1358 274">* The red seat belt warning lamp lights up for six seconds once the vehicle has started.</p> <p data-bbox="526 284 1044 310">In addition, an intermittent warning tone may sound.</p> <p data-bbox="526 310 1469 336">The red seat belt warning lamp reminds the driver and front passenger to fasten their seat belts.</p> <p data-bbox="526 341 914 367">► Fasten your seat belt (→ page 44).</p> <p data-bbox="526 388 1524 414">If you have placed objects on the front passenger seat, the red seat belt warning lamp may remain lit.</p>
 <p data-bbox="194 523 425 595">Occupant presence reminder warning lamp (white)</p>	<p data-bbox="508 429 1099 455">* The white occupant presence reminder warning lamp is lit.</p> <p data-bbox="526 455 1007 481">The occupant presence reminder is deactivated.</p> <p data-bbox="526 486 1173 512">► Switch on the occupant presence reminder, see (→ page 72).</p>
 <p data-bbox="194 709 471 782">Occupant presence reminder warning lamp (yellow)</p>	<p data-bbox="508 616 1108 642">* The yellow occupant presence reminder warning lamp is lit.</p> <p data-bbox="526 642 1025 668">The occupant presence reminder is malfunctioning</p> <p data-bbox="526 673 960 699">► Note the messages on the driver display.</p>

Drive system

Warning/indicator lamp	Possible causes/consequences and ► Solutions
 <p data-bbox="144 384 371 433">Reduced warning lamp power</p>	<p data-bbox="458 293 929 342">* The yellow reduced-power warning lamp is on. Drive system power output is reduced.</p> <p data-bbox="476 353 911 379">► Note the messages on the driver display.</p>

Vehicle



Warning/indicator lamp	Possible causes/consequences and ► Solutions
 <p data-bbox="144 673 376 722">Power steering warning lamp (yellow)</p>	<p data-bbox="458 582 1188 631">* The yellow power steering warning lamp is lit while the vehicle is running. The power assistance or the steering itself is malfunctioning.</p> <p data-bbox="476 642 911 668">► Note the messages on the driver display.</p>
 <p data-bbox="144 832 376 881">Power steering warning lamp (red)</p>	<p data-bbox="458 741 1160 791">* The red power steering warning lamp is lit while the vehicle is running. The power assistance or the steering itself is malfunctioning.</p>



Warning/indicator lamp	Possible causes/consequences and ► Solutions
	<p>▲ WARNING Risk of accident if steering capability is impaired</p> <p>If the steering does not function as intended, the vehicle's operating safety is jeopardized.</p> <ul style="list-style-type: none"> ► Pull over and stop the vehicle safely as soon as possible, paying attention to road and traffic conditions. Do not continue driving under any circumstances. ► Consult a qualified specialist workshop. <p>► Note the messages on the driver display.</p>

Engine

Warning/indicator lamp	Possible causes/consequences and ► Solutions
 <p>Coolant warning lamp (red)</p>	<p>* The red coolant warning lamp is lit while the engine is running.</p> <p>Possible causes:</p> <ul style="list-style-type: none"> • The temperature sensor is malfunctioning • The coolant level is too low • The air supply to the radiator is obstructed • The radiator fan is faulty • The engine coolant pump is faulty

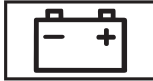

Warning/indicator lamp	Possible causes/consequences and ► Solutions
	<p>If there is an additional warning tone, the coolant temperature has exceeded the maximum permissible temperature.</p> <p>▲ WARNING Risk of burns when opening the hood</p> <p>If you open the hood in the event of an overheated engine or fire in the engine compartment, the following situations may occur:</p> <ul style="list-style-type: none">• You may come into contact with hot gases.• You may come into contact with other escaping hot operating fluids. <p>► Before opening the hood, allow the engine to cool down.</p> <p>► In the event of a fire in the engine compartment, keep the hood closed and call the fire service.</p> <p>► Stop immediately in accordance with the traffic conditions and switch off the vehicle. Do not continue driving.</p> <p>► Note the messages on the driver display.</p> <p>If the coolant temperature display is at the lower end of the temperature scale:</p> <p>► Consult a qualified specialist workshop.</p> <p>If the coolant temperature display is at the upper end of the temperature scale:</p> <p>► Exit the vehicle and keep a safe distance from it until the engine has cooled down.</p> <p>► Check the coolant level (→ page 336).</p> <p>► Make sure that the air supply to the radiator is not obstructed.</p>

Warning/indicator lamp	Possible causes/consequences and ► Solutions
 <p data-bbox="194 409 462 461">Coolant warning lamp (yellow)</p>	<p data-bbox="526 248 1663 300">► Avoiding high loads on the engine, drive to the nearest qualified specialist workshop. In doing so, ensure that the coolant temperature display remains below the red area.</p> <p data-bbox="508 315 1164 341">* The yellow coolant warning lamp is lit while the engine is running.</p> <p data-bbox="526 352 693 378">Possible causes:</p> <ul data-bbox="535 388 1127 481" style="list-style-type: none"> • The temperature sensor is malfunctioning • The charge air, transmission oil or battery cooling is faulty • The radiator shutters are blocked or defective <p data-bbox="526 497 1386 523">► Avoiding high loads on the engine, drive to the nearest qualified specialist workshop.</p>
 <p data-bbox="194 631 462 657">Check Engine warning lamp</p>	<p data-bbox="508 538 1506 626">* The yellow engine diagnostics warning lamp is lit while the engine is running. A malfunction has occurred in the engine, the exhaust system or the fuel system. This may cause the emissions limit values to be exceeded and the engine to run in emergency mode.</p> <p data-bbox="526 637 1681 688">In some states, legal requirements stipulate that you must immediately consult a qualified specialist workshop as soon as the yellow engine diagnostics warning lamp lights up.</p> <p data-bbox="526 699 1339 725">► Have the vehicle checked as soon as possible at a qualified specialist workshop.</p>
 <p data-bbox="194 828 462 880">Electrical malfunction warning lamp</p>	<p data-bbox="508 735 1007 787">* The red electrical malfunction warning lamp is lit. There is a malfunction in the electrics.</p> <p data-bbox="526 797 960 823">► Note the messages on the driver display.</p>

Warning/indicator lamp	Possible causes/consequences and ► Solutions
 <p data-bbox="144 342 408 391">Engine operating temperature warning lamp</p>	<p data-bbox="463 249 1535 301">* Vehicles with gasoline engines: after a cold start, the blue engine operating temperature warning lamp is on. Engine output and engine torque are reduced.</p> <ul style="list-style-type: none"> <li data-bbox="476 308 981 335">► Take this into consideration in your driving style.
 <p data-bbox="144 503 408 552">Fuel reserve warning lamp flashes</p>	<p data-bbox="463 410 1628 462">* The yellow fuel reserve warning lamp lights up while you are driving. There has been pressure loss in the fuel system. The fuel filler cap is not closed correctly or the fuel system is leaking.</p> <ul style="list-style-type: none"> <li data-bbox="476 469 746 496">► Close the fuel filler cap. <p data-bbox="476 521 999 548">If the fuel filler cap has already been closed correctly:</p> <ul style="list-style-type: none"> <li data-bbox="476 555 898 582">► Consult a qualified specialist workshop.
 <p data-bbox="144 689 408 738">Fuel reserve warning lamp lights up</p>	<p data-bbox="463 596 1197 648">* The yellow fuel reserve warning lamp lights up while the engine is running. The fuel supply has dropped into the reserve range.</p> <ul style="list-style-type: none"> <li data-bbox="476 655 583 682">► Refuel.



Brakes



Warning/indicator lamp	Possible causes/consequences and ► Solutions
<div data-bbox="205 296 362 379" data-label="Image"> </div> <p data-bbox="195 387 463 436">Electric parking brake indicator lamp (red) (USA only)</p> <div data-bbox="205 443 362 526" data-label="Image"> </div> <p data-bbox="195 534 463 609">Electric parking brake indicator lamp (red) (Canada only)</p> <div data-bbox="205 616 362 699" data-label="Image"> </div> <p data-bbox="195 707 463 756">Electric parking brake indicator lamp (yellow)</p>	<p data-bbox="510 294 1119 319">* The red electric parking brake indicator lamp flashes or is lit.</p> <p data-bbox="528 327 1406 352">The yellow electric parking brake indicator lamp is also lit up in the event of a malfunction.</p> <ul data-bbox="528 356 962 381" style="list-style-type: none"> <li data-bbox="528 356 962 381">► Note the messages on the driver display.



Warning/indicator lamp	Possible causes/consequences and ► Solutions
<div data-bbox="155 251 312 332" data-label="Image"> </div> <p data-bbox="144 342 380 391">RBS warning lamp (USA only)</p> <div data-bbox="155 397 312 478" data-label="Image"> </div> <p data-bbox="144 488 399 537">Brakes warning lamp (yellow) (Canada only)</p>	<p data-bbox="467 249 1641 298">*The yellow  warning lamp (USA only) or the yellow  brake warning lamp (Canada only) is lit while the vehicle is running.</p> <div data-bbox="482 322 1644 470" data-label="Complex-Block" style="border: 1px solid gray; padding: 5px;"> <p data-bbox="491 327 1171 353">▲ WARNING Risk of an accident due to a brake system malfunction</p> <p data-bbox="491 366 1258 392">If the brake system is malfunctioning, braking characteristics may be impaired.</p> <ul style="list-style-type: none"> <li data-bbox="491 399 707 425">▶ Drive on carefully. <li data-bbox="491 436 1299 462">▶ Have the brake system checked immediately at a qualified specialist workshop. </div> <ul style="list-style-type: none"> <li data-bbox="476 487 1391 513">▶ Adjust your speed and drive on carefully, leaving a suitable distance to the vehicle in front. <li data-bbox="476 524 1079 550">▶ If the driver's display shows a display message, observe it. <li data-bbox="476 560 898 586">▶ Consult a qualified specialist workshop.



Warning/indicator lamp	Possible causes/consequences and ► Solutions
<div data-bbox="203 253 360 336" data-label="Image"> </div> <p data-bbox="194 341 462 393">Brakes warning lamp (USA only)</p> <div data-bbox="203 398 360 481" data-label="Image"> </div> <p data-bbox="194 486 462 538">Brakes warning lamp (Canada only)</p>	<p data-bbox="508 248 1136 274">* The red brakes warning lamp is lit while the vehicle is running.</p> <p data-bbox="526 284 693 310">Possible causes:</p> <ul data-bbox="526 321 1459 378" style="list-style-type: none"> • The brake force boosting is malfunctioning and the braking characteristics may be affected. • There is insufficient brake fluid in the brake fluid reservoir. <p data-bbox="526 393 960 419">► Note the messages on the driver display.</p> <div data-bbox="526 440 1700 481" data-label="Section-Header"> <p>▲ WARNING Risk of accident and injury if brake force boosting is malfunctioning</p> </div> <p data-bbox="545 486 1644 538">If brake force boosting is malfunctioning, increased brake pedal force may be necessary for braking. The braking characteristics may be impaired. The braking distance can increase in emergency braking situations.</p> <ul data-bbox="545 549 1173 606" style="list-style-type: none"> ► Stop in a safe location immediately. Do not continue driving. ► Consult a qualified specialist workshop. <div data-bbox="526 637 1700 678" data-label="Section-Header"> <p>▲ WARNING Risk of an accident due to low brake fluid level</p> </div> <p data-bbox="545 683 1524 709">If the brake fluid level is too low, the braking effect and the braking characteristics may be impaired.</p> <ul data-bbox="545 720 1663 839" style="list-style-type: none"> ► Pull over and stop the vehicle safely as soon as possible, paying attention to road and traffic conditions. Do not continue driving under any circumstances. ► Consult a qualified specialist workshop. ► Do not add brake fluid.



Driving and driving safety systems

Warning/indicator lamp	Possible causes/consequences and ► Solutions
 <p data-bbox="144 384 325 410">ABS warning lamp</p>	<p data-bbox="463 294 1082 342">* The yellow ABS warning lamp is lit while the vehicle is running. ABS is malfunctioning.</p> <p data-bbox="476 353 1060 379">If an additional warning tone sounds, EBD is malfunctioning.</p> <p data-bbox="476 389 1230 415">Other driving systems and driving safety systems may also be malfunctioning.</p> <ul style="list-style-type: none"> <li data-bbox="476 425 907 451">► Note the messages on the driver display. <div data-bbox="482 467 1646 676" style="border: 1px solid black; padding: 5px;"> <p data-bbox="491 472 1203 498">⚠ WARNING There is a risk of skidding if EBD or ABS is malfunctioning</p> <p data-bbox="491 513 851 539">The wheels may lock during braking.</p> <p data-bbox="491 550 1618 596">The steerability and braking characteristics are heavily impaired and the braking distance may increase. In addition, other driving safety systems are switched off.</p> <ul style="list-style-type: none"> <li data-bbox="491 607 704 632">► Drive on carefully. <li data-bbox="491 643 1295 669">► Have the brake system checked immediately at a qualified specialist workshop. </div>
 <p data-bbox="144 788 412 814">ESP® warning lamp flashes</p>	<p data-bbox="463 695 1143 746">* The yellow ESP® warning lamp flashes while the vehicle is in motion. One or more wheels have reached their grip limit (→ page 194).</p> <ul style="list-style-type: none"> <li data-bbox="476 757 1138 783">► Adapt your driving style to suit the road and weather conditions.

Warning/indicator lamp	Possible causes/consequences and ► Solutions
 <p data-bbox="194 341 480 367">ESP® warning lamp lights up</p>	<p data-bbox="508 248 1145 305">* The yellow ESP® warning lamp is lit while the vehicle is running. ESP® is malfunctioning.</p> <p data-bbox="526 315 1386 341">Other driving systems and driving safety systems (e.g. BAS) may also be malfunctioning.</p> <p data-bbox="526 347 960 372">► Note the messages on the driver display.</p> <div data-bbox="526 388 1690 574" style="border: 1px solid black; padding: 5px;"> <p data-bbox="535 398 1099 429">▲ WARNING Risk of skidding if ESP® is malfunctioning</p> <p data-bbox="545 440 1653 492">If ESP® is malfunctioning, ESP® cannot carry out vehicle stabilization. In addition, other driving safety systems are switched off.</p> <ul style="list-style-type: none"> <li data-bbox="545 502 757 528">► Drive on carefully. <li data-bbox="545 538 1118 564">► Have ESP® checked at a qualified specialist workshop. </div>
 <p data-bbox="194 683 434 709">ESP® OFF warning lamp</p>	<p data-bbox="508 590 1191 647">* The yellow ESP® OFF warning lamp is lit while the vehicle is running. ESP® is deactivated.</p> <p data-bbox="526 657 1247 683">Other driving systems and driving safety systems may also be inoperative.</p> <div data-bbox="526 699 1690 849" style="border: 1px solid black; padding: 5px;"> <p data-bbox="535 709 1201 740">▲ WARNING Risk of skidding when driving with ESP® deactivated</p> <p data-bbox="545 751 1561 777">ESP® does not act to stabilize the vehicle. The availability of further driving safety systems is also limited.</p> <ul style="list-style-type: none"> <li data-bbox="545 787 757 813">► Drive on carefully. <li data-bbox="545 823 1145 849">► Deactivate ESP® only for as long as the situation requires. </div>

Warning/indicator lamp	Possible causes/consequences and ► Solutions
	<p>If ESP® cannot be activated, ESP® is malfunctioning.</p> <ul style="list-style-type: none"> ► Have ESP® checked immediately at a qualified specialist workshop. ► Observe the notes on deactivating ESP® (→ page 194).
 <p>ATTENTION ASSIST warning lamp</p>	<p>* The ATTENTION ASSIST warning lamp is lit. ATTENTION ASSIST is malfunctioning.</p> <ul style="list-style-type: none"> ► Consult a qualified specialist workshop.
 <p>Traffic Sign Assist warning lamp</p>	<p>* The Traffic Sign Assist warning lamp is lit. Traffic Sign Assist is malfunctioning.</p> <ul style="list-style-type: none"> ► Note the messages on the driver display.
 <p>Distance warning lamp</p>	<p>* The red distance warning lamp lights up while the vehicle is in motion. The distance to the vehicle in front is too small for the speed selected.</p> <p>If there is an additional warning tone, you are approaching an obstacle at too high a speed.</p> <ul style="list-style-type: none"> ► Be prepared to brake immediately. ► Increase the distance.

Warning/indicator lamp	Possible causes/consequences and ► Solutions
 <p data-bbox="195 384 467 436">Active Brake Assist warning lamp</p>	<p data-bbox="528 249 981 275">Function of Active Brake Assist (→ page 218).</p> <p data-bbox="510 291 1535 342">* The Active Brake Assist warning lamp is on. Due to dirty sensors or a malfunction, the system is not available or the range of functions is restricted.</p> <ul style="list-style-type: none"> <li data-bbox="528 353 957 379">► Note the messages on the driver display.
 <p data-bbox="195 544 467 596">Active Brake Assist warning lamp</p>	<p data-bbox="510 451 1369 534">* The Active Brake Assist warning lamp is on. The system is switched off or the range of functions has been automatically restricted. This may be the case if another driving system has been activated.</p> <ul style="list-style-type: none"> <li data-bbox="528 544 1119 570">► Observe the notes on Active Brake Assist (→ page 218).
 <p data-bbox="195 705 449 757">Suspension warning lamp (yellow)</p>	<p data-bbox="510 612 935 664">* The yellow AIRMATIC warning lamp is lit. A malfunction has occurred in AIRMATIC.</p> <ul style="list-style-type: none"> <li data-bbox="528 674 957 700">► Note the messages on the driver display.

Warning/indicator lamp	Possible causes/consequences and ► Solutions
 <p>Suspension warning lamp (yellow)</p>	<p>* The yellow E-ACTIVE BODY CONTROL warning lamp is on. There is a malfunction with E-ACTIVE BODY CONTROL.</p> <ul style="list-style-type: none"> ► Note the messages on the driver display.
 <p>Suspension warning lamp (red)</p>	<p>* The red AIRMATIC warning lamp is lit. A malfunction has occurred in AIRMATIC.</p> <div style="border: 1px solid gray; padding: 5px; margin-bottom: 10px;"> <p>! NOTE The vehicle's driving characteristics will have changed significantly.</p> <p>► Consult a qualified specialist workshop.</p> </div> <ul style="list-style-type: none"> ► Note the messages on the driver display. ► Consult a qualified specialist workshop.
 <p>Suspension warning lamp (red)</p>	<p>* The red E-ACTIVE BODY CONTROL warning lamp is on. There is a malfunction with E-ACTIVE BODY CONTROL.</p> <div style="border: 1px solid gray; padding: 5px; margin-bottom: 10px;"> <p>! NOTE The vehicle's driving characteristics will have changed significantly.</p> <p>► Consult a qualified specialist workshop.</p> </div> <ul style="list-style-type: none"> ► Note the messages on the driver display.

Warning/indicator lamp	Possible causes/consequences and ► Solutions
	<ul style="list-style-type: none"> ► Consult a qualified specialist workshop.

Mercedes-Benz emergency call system

Warning/indicator lamp	Possible causes/consequences and ► Solutions
 <p>Mercedes-Benz emergency call system warning lamp</p>	<p>*The Mercedes-Benz emergency call system is malfunctioning. The Mercedes me connect system is also malfunctioning.</p> <ul style="list-style-type: none"> ► Consult a qualified specialist workshop.

Tire pressure monitor

Warning/indicator lamp	Possible causes/consequences and ► Solutions
 <p>Tire pressure monitoring system warning lamp flashes</p>	<p>*The yellow tire pressure monitor warning lamp (pressure loss/malfunction) flashes for approximately one minute and then remains lit. The tire pressure monitoring system is malfunctioning.</p> <p>⚠ WARNING There is a risk of an accident if the tire pressure monitoring system is malfunctioning</p> <p>The tire pressure monitoring system cannot issue a warning if there is pressure loss in one or more of the tires.</p>

Warning/indicator lamp	Possible causes/consequences and ► Solutions
	<p>Tires with insufficient tire pressure may impair the driving characteristics as well as steering and braking.</p> <p>► Have the tire pressure monitoring system checked at a qualified specialist workshop.</p>
 <p>Tire pressure monitoring system warning lamp lights up</p>	<p>* The yellow tire pressure monitoring system warning lamp (pressure loss/malfunction) is lit. The tire pressure monitoring system has detected a loss of pressure in at least one tire.</p> <p>▲ WARNING Risk of an accident due to insufficient tire pressure</p> <ul style="list-style-type: none"> • The tires can burst. • The tires can wear excessively and/or unevenly. • The driving characteristics as well as the steering and braking may be greatly impaired. <p>You could then lose control of the vehicle.</p> <p>► Observe the recommended tire pressures.</p> <p>► Adjust the tire pressure if necessary.</p> <p>► Stop the vehicle in accordance with the traffic conditions.</p> <p>► Check the tire pressure and the tires.</p>

- 1, 2, 3 ...**
- (SmartKey) battery**..... 75
- 4MATIC**..... 179
- 48 V on-board electrical system**
 - Displays in the driver's display..... 277
 - Operating safety..... 27
- A**
- A/C function**
 - Activating/deactivating (MBUX)..... 149
 - Activating/deactivating (operating unit)..... 148
- ABS**..... 193
- Acceleration**
 - Kickdown..... 178
 - Optimized acceleration..... 159
- Accident, emergency call**..... 320
- Activating/deactivating the acoustic lock-
ing verification signal**..... 74
- Active Blind Spot Assist**
 - Activating/deactivating..... 230
 - Brake application..... 229
 - Exit warning..... 227
- Function..... 227
- Trailer operation..... 229
- Active Brake Assist**
 - Function..... 218
 - Setting..... 222
- Active Distance Assist DISTRONIC**
 - Activating/deactivating..... 204
 - Active Emergency Stop Assist..... 214
 - Active Lane Change Assist..... 216
 - Active Speed Limit Assist..... 206
 - Calling up a speed..... 204
 - Function..... 202
 - Increasing/decreasing the speed..... 204
 - Route-based speed adaptation..... 207
 - Storing a speed..... 204
- Active Emergency Stop Assist**..... 214
- Active headlamps**..... 136
- Active Lane Change Assist**
 - Activating/deactivating..... 217
 - Function..... 216
- Active Lane Keeping Assist**
 - Activating/deactivating..... 232
 - Function..... 230
 - Setting the sensitivity..... 232
- Towing a trailer..... 230
- Active light function**..... 136
- Active Parking Assist**
 - Automatic braking function..... 260
 - Exiting a parking space..... 259
 - Function..... 255
 - Maneuvering brake function..... 262
 - Parking..... 257
 - Pausing..... 260
- Active Service System PLUS**..... 330
- Active Speed Limit Assist**..... 206
- Active Steering Assist**
 - Activating/deactivating..... 214
 - Active Emergency Stop Assist..... 214
 - Active Lane Change Assist..... 216
 - Function..... 212
- Active Stop-and-Go Assist**
 - Function..... 209
- Adaptive cruise control**..... 207
- Adaptive Highbeam Assist**
 - Activating/deactivating..... 137
- Additives**
 - Engine oil..... 410

- Fuel..... 410
- After-sales service**..... 330
- Air bag**
 - Front air bag..... 57
 - Inflating..... 52
 - Overview..... 57
 - PASSENGER AIR BAG indicator lamp..... 46
 - Warning lamp..... 44
- Air conditioning menu**
 - Air distribution..... 149
 - Climate control..... 149
 - Fragrance system..... 151
 - Ionization..... 151
 - Rear passenger compartment climate control..... 150
- Air distribution**
 - Adjusting..... 149
 - Setting..... 147
- Air freshener system**..... 151
- Air inlet**..... 338
- Air pressure**..... 371
- Air suspension**..... 233
- Air vents**
 - Adjusting..... 153
 - Glove box..... 154
- Air/water duct**..... 338
- Airflow**
 - Setting..... 147
- AIRMATIC**
 - Lowering/raising the rear end of the vehicle..... 236
 - Setting entering/exiting level..... 236
 - Setting the vehicle level..... 234
 - Vehicle level..... 233
- Alarm system**..... 95
- All-wheel drive**..... 179
- Alternative route**..... 302
- Ambient lighting**..... 138
- Animals**..... 53
- Anti-lock braking system**..... 193
- Anti-theft alarm system**..... 95
- Anti-theft protection**
 - Immobilizer..... 94
- Apps, Mercedes me**
 - Mercedes me calls..... 313
 - Mercedes me connect..... 316
- Ashtray**
 - Using..... 127
- Assistance system**..... 192
- ASSYST PLUS**
 - Battery disconnection periods..... 331
 - Service interval display..... 330
 - Service requirements..... 330
- ATA**
 - Deactivating the alarm..... 95
 - Function..... 95
 - Interior protection..... 97
 - Interior protection function..... 96
 - Tow-away alarm function..... 95
 - Tow-away protection..... 96
- ATTENTION ASSIST**
 - Function..... 198
 - Setting..... 200
- Attention assistant**..... 198
- Authorized Mercedes-Benz Service Center**.... 32
- Authorized workshop**..... 32



























- Automatic car wash..... 338
 - Automatic car wash mode..... 340
 - Automatic climate control..... 149
 - Automatic distance control..... 202
 - Automatic driving lights..... 134
 - Automatic emergency call..... 320
 - Automatic engine start/stop..... 166
 - Automatic front passenger air bag shutoff
 - Function..... 48
 - Information (child restraint system on the front passenger seat)..... 62
 - PASSENGER AIR BAG indicator lamp..... 46
 - Automatic measures after an accident..... 51
 - Automatic mirror folding function..... 145
 - Automatic seat adjustment..... 105
 - Automatic transmission
 - DIRECT SELECT lever..... 174
 - Drive programs..... 170
 - DYNAMIC SELECT button..... 170
 - Engages neutral..... 175
 - Engaging drive position..... 176
 - Engaging reverse gear..... 175
 - Kickdown..... 178
 - Manual gear shifting..... 177
 - Oil temperature (driver's display)..... 275
 - Selecting park position..... 176
 - Steering wheel paddle shifters..... 177
 - Switching gears..... 174
 - Transmission position display..... 174
 - Transmission positions..... 174
 - Autonomous braking..... 218
- B**
- Bag hook..... 122
 - Ball neck
 - Installing..... 268
 - BAS..... 193
 - Basic information..... 41
 - Battery (12 V battery)
 - Charging..... 359
 - Notes..... 354
 - Notes (starting assistance and charging)..... 357
 - Replacing..... 361
 - Starting assistance..... 359
 - Battery (48 V)
 - Notes..... 356
 - Battery (starter battery)
 - charging, Remote Online..... 157
 - Belt
 - Fastening..... 44
 - Notes on wearing correctly..... 43
 - Releasing..... 57
 - To adjust the height..... 44
 - Bicycle rack
 - Load capacity..... 417
 - Blind Spot Assist
 - Activating/deactivating..... 230
 - Function..... 227
 - Bluetooth®
 - Connecting a mobile phone..... 311
 - Boost pressure, current (driver's display)..... 275
 - Brake Assist
 - Active Brake Assist..... 218
 - Brake Assist System..... 193
 - Brake Assist System..... 193
 - Brake disks..... 158







































- Brake fluid**..... 411
- Brake force distribution**..... 196
- Brake pads**..... 158
- Brakes**
- ABS (Anti-lock Braking System)..... 193
 - Active Brake Assist..... 218
 - BAS (Brake Assist System)..... 193
 - Driving tips..... 160
 - EBD (Electronic Brakeforce Distribution)..... 196
 - Electric parking brake..... 186
 - Handbrake..... 186
 - HOLD function..... 197
 - Limited braking effect (salt-treated roads)..... 160
 - New/replaced brake pads/brake discs.. 158
 - Notes on breaking in a new vehicle..... 158
 - Parking brake..... 186
 - Post-collision brake..... 51
- Braking assistance**
- Active Brake Assist..... 218
 - Brake Assist System..... 193
- Breakdown**
- Changing a wheel..... 393
 - Flat tire..... 350
 - Overview of aids..... 20
 - Tow-starting..... 366
 - Towing methods..... 362
 - Transporting the vehicle..... 364
- Breakdown (Roadside Assistance)**..... 26
- C**
- Calling the customer center for Mercedes-Benz**..... 313
- Calls**
- Mercedes me..... 312
 - Telephone menu..... 312
 - Using overhead control panel..... 312
- Camera**
- 360° camera..... 245
 - Activating using GPS (reversing camera)..... 251
 - Button..... 251
 - Care..... 343
 - Cleaning..... 343
 - Function..... 245
 - Information..... 191
 - Managing activation points..... 251
 - Off-road function..... 249
 - Opening the camera cover (rear view camera)..... 251
 - Rear view camera..... 242
 - ROAD SURFACE SCAN..... 239
 - Select view..... 251
 - Transparent hood..... 249
- Car key**..... 73
- Car wash**
- Automatic car wash..... 338
 - Automatic car wash mode..... 339
 - Power washer..... 340
 - Washing by hand..... 341
- Car-to-X-Communication**
- Display on map..... 305
- Care**
- Air/water duct..... 338
 - Automatic car wash..... 338
 - Automatic car wash mode..... 339
 - Camera..... 343
 - Decorative foil..... 342
 - Display..... 345
 - Exterior lighting..... 343
 - Genuine wood/trim elements..... 345

- Head-up display..... 345
- Headliner..... 345
- Paint..... 341
- Plastic trim..... 345
- Power washer..... 340
- Running boards..... 343
- Seat belt..... 345
- Steering wheel..... 345
- Trailer hitch..... 343
- Vehicle interior..... 345
- Vehicle parts..... 343
- Washing by hand..... 341
- Wheels/rims..... 343
- Care of the headliner..... 345**
- Care of the plastic trim..... 345**
- Care of the steering wheel..... 345**
- Cargo compartment floor**
 - Locking/unlocking..... 124
- Cargo tie-down rings..... 121**
- Caring for rims..... 343**
- Central display**
 - Operating..... 281
- Central locking system**
 - Button..... 77
 - SmartKey..... 74
- Change of address..... 27**
- Change of ownership..... 27**
- Changing a wheel**
 - Preparation..... 393
 - Raising the vehicle..... 394
- Charging**
 - 12 V battery..... 359
 - USB port..... 117, 129
 - Wirelessly charging a mobile phone..... 129
- Checking the coolant level..... 336**
- Child safety lock**
 - Rear door..... 70
 - Side windows (rear passenger compartment)..... 72
- Child seat**
 - Adjusting the vehicle seat..... 64
 - Basic instructions..... 58
 - Front passenger seat..... 62
 - Installing ISOFIX..... 67
 - Rearward-facing..... 64
- Risks/dangers..... 60
- Securing on the rear seat with the seat belt..... 70
- Securing to the front passenger seat with the seat belt..... 70
- The most important information in brief.... 58
- Top Tether..... 68
- Children**
 - Avoiding dangers in the vehicle..... 60
 - Basic instructions..... 58
 - Special seat belt retractor..... 66
- Chock..... 392**
- Clean varnish..... 341**
- Cleaning**
 - Air/water duct..... 338
 - Automatic car wash..... 338
 - Automatic car wash mode..... 339
 - Camera..... 343
 - Decorative foil..... 342
 - Genuine wood/trim elements..... 345
 - Paint..... 341
 - Power washer..... 340
 - Sensors..... 343
 - Vehicle interior..... 345

- Vehicle parts..... 343
Washing by hand..... 341
- Cleaning carpet**..... 345
- Cleaning the seat cover**..... 345
- Climate control**, Air-conditioning system,
Blower, Cooling
- Activating/deactivating..... 148
 - Activating/deactivating (rear operating unit)..... 148
 - Activating/deactivating the A/C function (control panel)..... 148
 - Activating/deactivating the A/C function (MBUX)..... 149
 - Activating/deactivating the synchronization function (control panel)..... 150
 - Air vents (front)..... 153
 - Air vents (rear passenger compartment)..... 154
 - Automatic control..... 149
 - Automatically controlling (rear operating unit)..... 149
 - Control panel for 3-zone automatic climate control..... 147
 - Control panel for dual-zone automatic climate control..... 147
- Defrosting a window..... 148
Defrosting the windshield..... 147
Defrosting windows..... 150
Filling capacity for refrigerant and PAG oil..... 414
Fragrance system..... 151
Glove box air vent..... 154
Inserting/removing the flacon (fragrance system)..... 152
Ionization..... 151
Notes..... 147
Rear operating unit..... 18
Rear passenger compartment operating unit..... 148
Refrigerant..... 413
Residual heat..... 151
Setting the air distribution..... 147
Setting the airflow..... 147
Setting the vehicle interior temperature..... 147
Switching air-recirculation mode on/off..... 150
Switching the rear window heater on/off..... 147
Synchronization function..... 150
Ventilation with comfort opening..... 88
- Clothes hooks**
Using..... 123
- Coat hook**..... 123
- COC papers, CERTIFICATE OF CONFORMITY**..... 403
- Cockpit**
Instrument panel..... 6
- Coffee cup symbol**..... 198
- Collapsible cargo compartment cover**
Notes..... 120
Removing/installing..... 121
Unfolding/folding up..... 120
- Collapsible spare wheel**
Inflating..... 401
Notes..... 400
Removing..... 401
- Collision detection (parked vehicle)**
Setting..... 188, 189
- Combination switch**
Lights..... 134
Windshield wipers..... 139
- Commuter route**..... 302

- Components relevant to radio regulation**
 Declaration of conformity..... 30
- Composition of the tire**..... 384
- Control elements**..... 25
- Convenience closing feature**..... 89
- Convenience opening**..... 88
- Coolant**
 Capacity..... 412
 Notes..... 411
- Copyright**
 License..... 40
- Copyrights**
 Trademarks..... 40
- Correct use**..... 32
- Cover**..... 90
- Cross traffic (warning)**..... 261
- Cross Traffic Alert, Cross traffic warning**..... 261
- Crosswind Assist**..... 195
- Cruise control**
 Activating/deactivating..... 200
 Calling up a speed..... 200
 Function..... 200
- Requirements:..... 200
 Setting a speed..... 200
 Storing a speed..... 200
- Customer Assistance Center (CAC)**..... 34
- D**
- Damage**
 Limited protection..... 53
- Damping system ADS PLUS**
 AIRMATIC..... 233
 E-ACTIVE BODY CONTROL..... 237
 Setting the vehicle level..... 234
- Dashcam**
 Notes..... 307
 Selecting a USB device..... 308
 Starting/stopping an individual recording..... 309
 Starting/stopping loop recording..... 308
- Data processing in the vehicle**..... 35
- Data protection rights**..... 38
- Data storage**
 Data protection rights..... 38
 Electronic control units..... 35
- Event Data Recorder..... 39
 MBUX multimedia system/Mercedes me connect..... 39
 Online services..... 38
- Daytime running lamps, Daytime running lamp mode**
 Activating/deactivating..... 137
- Deactivating the alarm**..... 95
- Dealership**..... 32
- Declaration of conformity**
 Components relevant to radio regulation.. 30
- Decorative foil**..... 342
- Definitions**
 Tires and loading..... 387
- Defrost function**..... 148
- Deployed components**
 Limited protection..... 53
- Deployment situations**..... 52
- Destination entry**..... 301
- Detecting inattentiveness**..... 198
- Diagnostics connection**..... 31
- Digital Operator's Manual**..... 22

- Dinghy towing**
 Pulling/towing..... 271
- DIRECT SELECT lever**
 Automatic transmission..... 174
 Engages neutral..... 175
 Engaging drive position..... 176
 Engaging park position automatically..... 176
 Engaging reverse gear..... 175
 Function..... 174
 Gearshift recommendation..... 178
 Manual gearshifting..... 177
 Selecting park position..... 176
- Display**
 Care..... 345
- Display (driver's display)**
 Overview of displays..... 277
- Display (MBUX multimedia system)**
 Settings..... 277
- Display message**
 Calling up on driver display..... 419
 Notes..... 419
- Display messages**
 --- mph..... 455
-  --- mph..... 450
-  2nd Seat Row, Center Not Locked..... 434
-  12 V On-board Electrical System Service Required..... 467
-  48 V Battery See Operator's Manual..... 469
-  Active Headlamps Inoperative..... 426
-  Add Washer Fluid..... 431
-  ATTENTION ASSIST: Take a Break!..... 449
-  Automatic Driving Lights Inoperative..... 426
-  Battery Overheated Stop! Everyone Get Out! Outdoors if Possible.. 469
-  Camera View Reduced See Operator's Manual..... 464
-  Cannot Fold Forward 2nd Seat Row, Left Adjust Front Seat..... 434
-  Cannot Fold Forward 2nd Seat Row, Right Adjust Front Seat..... 435
-  BRAKE Check Brake Fluid Level..... 445
-  Check Coolant Level See Operator's Manual..... 435
-  Check Engine Oil Level At Next Refueling (Add 1 Quart)..... 474
-  Check Left Low Beam (example).. 428
-  Check Tires..... 471
-  Compressor Is Cooling..... 452
-  Coolant Stop Switch Off Vehicle... 436
-  Currently Unavailable See Operator's Manual..... 446
-  Currently Unavailable See Operator's Manual..... 447
-  Do Not Exceed 25 mph..... 455
-  Do Not Leave People or Animals in the Vehicle..... 423
-  Don't Forget Your Key..... 425
-  Dynamic Low Beam Inoperative... 427

- | | | |
|----------------------------------------------------------------------------------------------------------------------------------------------|------------------------------------------------------------------------------------------------------------------------------------------------------|------------------------------------------------------------------------------------------------------------------------------------------------------------------|
|  Engine Oil Level Cannot Be Measured..... 476 |  Inoperative See Operator's Manual..... 449 |  Off..... 449 |
|  Engine Oil Level Reduce Oil Level..... 474 |  Inoperative..... 467 |  Parking Brake See Operator's Manual..... 441 |
|  Engine Oil Level Stop Switch Off Vehicle..... 475 |  Inoperative..... 454 |  Please Correct Tire Pressure..... 472 |
|  Engine Oil Pressure Stop Switch Off Vehicle..... 475 |  Key Not Detected (red display message)..... 424 |  Please Wait Charging 48 V Battery..... 469 |
|  Front Left Malfunction Service Required (example)..... 420 |  Key Not Detected (white display message)..... 423 |  Reduce Speed..... 473 |
|  Fuel Filler Cap Open..... 437 |  Left Window Airbag Malfunction Service Required (example)..... 420 |  Release Parking Brake..... 444 |
|  Fuel Reserve..... 437 |  Lowering..... 451 |  Replace Key Battery..... 423 |
|  Functions Limited When Towing Trailer..... 465 |  Malfunction Do Not Exceed 50 mph..... 451, 453 |  Restraint System Malfunction Service Required..... 420 |
|  Initializing Key Please Wait..... 424 |  Malfunction See Operator's Manual..... 426 |  Rising..... 451 |
|  Initiating Emergency Stop..... 459 |  Malfunction Stop..... 454 |  Slow Down..... 452 |
|  Inoperative See Operator's Manual..... 447 |  Not in Curr. Drive Prog..... 455 |  Steering Malfunction Increased Physical Effort See Operator's Manual.... 433 |
|  Inoperative See Operator's Manual..... 448 |  459 |  Steering Malfunction Stop Immediately See Operator's Manual..... 432 |
| |  Obtain a New Key..... 425 |  Stop Vehicle See Operator's Manual..... 467 |
| |  Off..... 456 | |

-  Stop Vehicle To Charge the 12 V Battery Do Not Switch Off Vehicle..... 468
-  Suspended..... 456
-  Switch Off Lights..... 427
-  Switch On Headlights..... 427
-  Switch on vehicle to charge the 12 V battery..... 468
-  Switch on Vehicle to Release the Parking Brake..... 444
-  Temporarily Unavailable Sensors Dirty..... 463
-  Tires Overheated..... 473
-  Vehicle Rising Please Wait..... 452
-  Warning Tire Malfunction..... 472
-  Wheel Sensor(s) Missing..... 471
- Active Blind Spot Assist Currently Unavailable See Operator's Manual..... 461
- Active Blind Spot Assist Inoperative..... 461
- Active Blind Spot Assist Not Available When Towing Trailer See Operator's Manual..... 462
- Active Brake Assist Functions Currently Limited See Operator's Manual..... 457
- Active Brake Assist Functions Limited See Operator's Manual..... 458
- Active Distance Assist Currently Unavailable See Operator's Manual..... 456
- Active Distance Assist Inoperative..... 456
- Active Distance Assist Now Available..... 457
- Active Lane Keeping Assist Currently Unavailable See Operator's Manual..... 462
- Active Lane Keeping Assist Inoperative... 462
- Active Lane Keeping Assist Limited Range of Functions See Operator's Manual..... 462
- Active Parking Assist and PARKTRONIC Inoperative See Operator's Manual..... 466
- Active Steering Assist Currently Unavailable Due to Multiple Emergency Stops..... 459
- Active Steering Assist Currently Unavailable See Operator's Manual..... 458
- Active Steering Assist Inoperative..... 458
- Active Stop & Go Assist Currently Unavailable See Operator's Manual..... 460
- Active Stop & Go Assist Inoperative See Operator's Manual..... 460
- Adaptive Highbeam Assist Currently Unavailable See Operator's Manual..... 428
- Adaptive Highbeam Assist Inoperative... 428
- Auxiliary Battery Malfunction (red display message)..... 440
- Auxiliary Battery Malfunction (white display message)..... 440
- Blind Spot Assist Currently Unavailable See Operator's Manual..... 460
- Blind Spot Assist Inoperative..... 461

Blind Spot Assist Not Available When Towing Trailer See Operator's Manual.....	461	N Permanently Active Risk of Rolling Away.....	439	Service Required Apply Parking Brake to Park.....	438
Cannot Start Vehicle See Operator's Manual.....	430	Occupant Presence Reminder Inoperative.....	422	Service Required Do Not Change Transmission Position.....	439
Check Brake Pads See Operator's Manual.....	445	PARKTRONIC Inoperative See Operator's Manual.....	466	Shift to P Only When Vehicle Is Stationary.....	437
Cruise Control Inoperative.....	450	Place the Key in the Marked Space See Operator's Manual.....	425	Starting Possible Again.....	470
Cruise Control Off.....	450	PRE-SAFE Inoperative See Operator's Manual.....	465	Stop Vehicle Leave Engine Running Wait Transmission Cooling.....	440
Depress Brake to Shift from P.....	437	PRE-SAFE Pulse Side Inoperative See Operator's Manual.....	465	Tire Pressure Monitor Currently Unavailable.....	470
Depress Brake to Shift to D or R.....	438	Reduced Drive System Performance See Operator's Manual.....	429	Tire Pressure Monitor Inoperative.....	470
Depress Brake to Shift to R.....	438	Reversing Not Possible Service Required.....	439	Tire Pressure Monitor Inoperative Tire Pressure Sensors Missing.....	471
Front Passenger Airbag Disabled See Operator's Manual.....	421	Risk of Vehicle Rolling Away Apply Parking Brake When Parking.....	439	To Deselect P or N Depress Brake and Start Vehicle.....	438
Front Passenger Airbag Enabled See Operator's Manual.....	421	Risk of Vehicle Rolling Away Driver's Door Open Position P Not Selected.....	438	To Switch Off Vehicle Press and Hold Start/Stop Button for at Least 3 Seconds or Press 3 Times.....	435
Hazard Warning Light Malfunction.....	429				
Head-up Display Currently Unavailable See Operator's Manual.....	432				
Head-up Display Inoperative.....	432				
MULTIBEAM LED Functions Limited.....	427				

- Traffic Sign Assist Currently Unavailable See Operator's Manual..... 450
- Traffic Sign Assist Inoperative..... 450
- Transmission Malfunction Stop..... 439
- Vehicle Ready to Drive Shutdown Occurs When Locked or After a Few Minutes..... 431
- Vehicle Ready to Drive Shutdown Occurs When Locked or Automatically in XX Mins..... 430
- Windshield Wiper Malfunction..... 431
- Displaying road names/house numbers..... 302
- Distance control..... 202
- Distance warning..... 218
- DISTRONIC..... 202
- Door**
- Child safety lock (rear door)..... 70
 - Emergency key..... 80
 - Opening (from the inside)..... 77
 - Power closing function..... 80
 - Unlocking (inside)..... 77
- Door operating unit**
- Function seat..... 16
- Door operating unit (rear passenger compartment)..... 18**
- DOT, Tire Identification Number (TIN)..... 382
- Downhill Speed Regulation..... 209
- Drinking and driving..... 160
- Drinks holder, Cup holder..... 126
- Drive Away Assist..... 260
- Drive position..... 176
- Drive program display..... 172
- Drive programs
- Selecting..... 172
- Driver display**
- Identifying malfunctions..... 272
- Driver's display, Instrument cluster**
- 48 V on-board electrical system..... 277
 - Head-up display..... 275
 - Instrument cluster..... 10
 - Menus..... 274
 - Notes..... 272
 - Operating..... 273
- Service due date..... 330
- Status displays..... 277
- Warning/indicator lamps..... 476
- Driver's seat**
- Adjusting electrically..... 99
 - Easy entry and exit feature..... 110
 - Seat heating..... 106
- Driving safety system**
- ABS (Anti-lock Braking System)..... 193
 - Active Brake Assist..... 218
 - Active Lane Change Assist..... 216
 - Active Steering Assist..... 212
 - ATTENTION ASSIST..... 198
 - BAS (Brake Assist System)..... 193
 - Blind Spot Assist / Active Blind Spot Assist..... 227
 - Cameras..... 191
 - Cruise control..... 200
 - EBD (Electronic Brakeforce Distribution)..... 196
 - ESP® (Electronic Stability Program)..... 194
 - Hill Start Assist..... 198
 - HOLD function..... 197
 - Off-road ABS..... 193
 - Overview..... 192

- Radar and ultrasonic sensors..... 191
 - STEER CONTROL..... 196
 - Traffic Sign Assist..... 223
 - Trailer Maneuvering Assist..... 263
 - Your responsibility..... 190
 - Driving system**..... 192
 - Driving tips**
 - Drinking and driving..... 160
 - General driving tips..... 160
 - Notes on breaking in a new vehicle..... 158
 - Off-road driving..... 163
 - Optimized acceleration..... 159
 - Drowsiness detection**..... 198
 - DSR**
 - Activating/deactivating..... 210, 211
 - Changing the target speed..... 211
 - Function..... 209
 - Notes..... 210
 - Duplicate key**..... 76
 - Dynamic handling control system**..... 194
 - DYNAMIC SELECT**
 - Calling up the fuel consumption indicator..... 174
 - Configuring drive program I..... 173
 - Displaying engine data..... 173
 - Displaying vehicle data..... 173
 - Drive program display..... 172
 - Drive programs..... 170
 - Function..... 170
 - Selecting the drive program..... 172
- E**
- E-ACTIVE BODY CONTROL**
 - Electrohydraulic suspension..... 237
 - Individual wheel control..... 240
 - Recovery mode..... 240
 - ROAD SURFACE SCAN..... 239
 - Setting the vehicle level..... 241
 - Suspension..... 237
 - Vehicle levels..... 237
 - E10**..... 409
 - E25**..... 409
 - Easy entry feature**
 - Adjusting..... 112
 - Function..... 110
 - Easy exit feature**
 - Adjusting..... 112
 - Function..... 110
 - EASY-PACK load-securing kit**
 - Installing/removing the telescopic rod... 123
 - Notes..... 123
 - EBD, Electronic Brakeforce Distribution**..... 196
 - ECO Assist**
 - 48 V on-board electrical system..... 169
 - ECO display**..... 168
 - ECO start/stop button**
 - Automatic engine start/stop..... 167
 - ECO start/stop function**
 - Automatic engine start..... 166
 - Automatic engine stop..... 166
 - Function..... 166
 - Switching off/on..... 167
 - Electric parking brake**
 - Applying automatically..... 186
 - Emergency braking..... 188
 - Manually applying/releasing..... 188
 - Releasing automatically..... 187
 - Electrical fuses**..... 366
 - Electrohydraulic chassis**..... 237
 - Electrohydraulic suspension**..... 237

- Electronic Stability Program**..... 194
- Emergency**
- First-aid kit (soft sided)..... 349
 - Overview of aids..... 20
 - Reflective safety vest..... 348
 - Warning triangle..... 349
- Emergency braking**
- Active Brake Assist..... 218
 - Brake Assist System..... 193
 - Carrying out..... 188
 - Electric parking brake/handbrake..... 186
- Emergency key**
- Door..... 80
 - Tailgate..... 87
- Emergency operation mode**
- Starting the vehicle..... 157
- Emergency spare wheel**
- Inflating..... 399
- Emergency stop assistant**..... 214
- Emergency Tensioning Devices**
- Inflating..... 52
- Engine**
- Emergency operation mode..... 157
 - Emergency start..... 366
 - Engine number..... 405
 - Jump-starting..... 357
 - Parking (start/stop button)..... 182
- Engine data**
- Displaying..... 173
 - DYNAMIC SELECT..... 173
- Engine number**..... 405
- Engine oil, Oil**
- Additives..... 410
 - Capacity..... 411
 - Checking the oil level using the driver display..... 334
 - MB-Freigabe / MB-Approval..... 411
 - Quality..... 411
 - Refilling..... 335
 - Temperature (driver's display)..... 275
- Engine oil temperature (driver's display)**..... 275
- Engine output, current (driver's display)**..... 275
- Environmentally friendly driving**..... 23
- ESC, Electronic Stability Control**..... 194
- ESP®**
- Activating/deactivating..... 195
 - Activating/deactivating (button)..... 196
 - Crosswind Assist..... 195
 - Function..... 194
 - Trailer stabilization..... 195
- Event Data Recorder**..... 39
- Exit warning**
- Blind Spot Assist / Active Blind Spot Assist..... 227
- Exiting a parking space**
- Active Parking Assist..... 255
 - Drive Away Assist..... 260
 - PARKTRONIC..... 251
- Exterior lighting**
- Care..... 343
- Exterior mirrors**
- Parking position..... 144
- F**
- Factory settings**
- MBUX reset function..... 295
- Favorites**..... 289
- Film coverings**
- On camera/sensors..... 191

- First aid**
 First-aid kit (soft sided)..... 349
- First-aid kit (soft sided)..... 349**
- Fitting**
 Snow chains..... 371
- Fitting accessories**
 Limited protection..... 53
- Flacon..... 152**
- Flat tire**
 Changing a wheel..... 393
 Notes..... 350
 TIREFIT kit..... 351
- Flat towing**
 Pulling/towing..... 271
- Floor mats..... 131**
- Fog lamp..... 134**
- Foil covering**
 Radar and ultrasonic sensors..... 191
- Fragrance..... 151**
- Fragrance system**
 Activating/deactivating..... 151
 Adjusting..... 151
- Inserting/removing the flacon..... 152
 Perfume vial..... 152
- Free driving mode**
 Starting..... 296
- Free software..... 40**
- Frequencies**
 Two-way radio..... 404
- Front air bag**
 Inflating..... 52
- Front headlamps..... 133**
- Front passenger air bag**
 Disabling/enabling..... 48
- Front passenger air bag shutoff,**
 PASSENGER AIR BAG OFF
 Information (child restraint system on
 the front passenger seat)..... 62
- Front passenger seat**
 Adjusting electrically..... 99
 Adjusting from driver's seat..... 101
- Fuel**
 Additives..... 410
 E10..... 409
 E25..... 409
- Gasoline..... 409
 Gasoline quality..... 409
 Refilling..... 179
 Reserve..... 410
 Sulfur content..... 409
 Tank capacity..... 410
- Fuel consumption indicator..... 174**
- Fuel reserve..... 410**
- Function in the event of an accident..... 52**
- Function seat..... 16**
- Function seat (rear passenger compart-
 ment)..... 18**
- Fuses**
 Cargo compartment..... 369
 Cockpit..... 368
 Engine compartment..... 367
 Fuse assignment diagram..... 366
 Notes..... 366
 Passenger footwell..... 368
- G**
- G-meter, Accelerometer..... 275**

- Garage door opener**
 Clearing the memory..... 186
 Opening/closing a door..... 186
 Problem..... 186
- Garage door openers**
 Programming buttons..... 184
 Synchronizing the rolling code..... 185
- Gasoline**..... 409
- Gearshift**
 DIRECT SELECT lever..... 174
 Manual..... 177
- General driving tips**..... 160
- Genuine parts**..... 23
- Glide mode**..... 178
- Glove box**
 Air vent..... 154
- Grab handles**..... 98
- H**
- Handbrake**..... 186
- Handling characteristics**
 Unusual..... 370
- HANDS-FREE ACCESS**..... 84
- Hazard warning lights**..... 135
- Hazard warnings**
 Car-to-X-Communication..... 305
- Head restraint**
 Adjusting (rear passenger compartment)..... 104
 Adjusting manually (front)..... 102
 Luxury head restraint (front)..... 103
 Removing/installing (rear passenger compartment)..... 104
- Head-up display**
 Care..... 345
 Function..... 275
 Memory function..... 113
 Operating..... 276
 Switching on/off..... 276
- Headlamp flashing**..... 134
- Headlamps**..... 133
- Heating**
 Activating/deactivating..... 148
 Center console..... 148
 Seat..... 106
- Steering wheel..... 110
- Help call**
 Mercedes-Benz emergency call system.. 320
- High beam**..... 134
- Hill descent control**..... 209
- Hill Start Assist**..... 198
- HOLD function**
 Function..... 197
 Switching on/off..... 197
- Home screen**
 Central display..... 281
- Hood**
 Opening/closing..... 332
- I**
- Identification plate**
 Engine..... 405
 Refrigerant..... 413
 Vehicle..... 405
- Immobilizer**..... 94
- Incorrect behavior by vehicle occupants**
 Limited protection..... 53

- Indicator/warning lamps**
 Driver's display..... 476
 PASSENGER AIR BAG..... 46
- Individual drive program**
 Configuring..... 173
- Inside rearview mirror**..... 144
- Installing**
 Tires/wheels..... 396
- Instrument panel**
 Cockpit..... 6
- Interior lighting**
 Adjusting..... 138
 Ambient lighting..... 138
 MBUX reading light..... 286
 Switch-off delay time..... 139
- Interior protection**..... 97
- Internet**
 Mercedes me connect..... 316
 Setting up a Wi-Fi hotspot..... 292
 Web browser..... 318
- Ionization**..... 151
- ISOFIX child seat anchor**
 Installing..... 67
- J**
- Jack**
 Storage location..... 392
- Jump-start connection**..... 359
- K**
- Key**
 Problem..... 76
 Replacement key..... 76
- KEYLESS-GO**
 Deactivating..... 74
 Locking/unlocking the vehicle..... 78
 Problem..... 79
 Unlocking setting..... 74
- Kickdown**..... 178
- Knee bag**..... 57
- L**
- Lane Change Assist**..... 216
- Lane Keeping Assist**..... 230
- Lane recognition**
 Active Lane Change Assist..... 216
 Active Lane Keeping Assist..... 230
- Lane scan**..... 239
- Language**
 Notes..... 294
 Setting..... 294
- Level control**
 AIRMATIC..... 233
 E-ACTIVE BODY CONTROL..... 237
- License plate (front)**..... 30
- License plate assembly (front)**..... 30
- Light switch**..... 133
- Lighting**
 Interior lighting..... 138
- Lights**
 Active headlamps..... 136
 Adaptive Highbeam Assist..... 136
 Automatic driving lights..... 134
 Combination switch..... 134
 Hazard warning lights..... 135
 High beam..... 134
 Interior lighting..... 138
 Locator lighting..... 138
 Reading lamp..... 138
 Reading light..... 286

- Rear fog light..... 134
Responsibility for lighting systems..... 133
Switch-off delay time..... 137
Switching on the daytime running
lamps..... 137
Turn signals..... 134
- Limited Warranty**..... 35
- Live Traffic Information**..... 305
- Load capacity**
Bicycle rack..... 417
- Load index**
Tires..... 384
- Load-bearing capacity**
Tires..... 384
- Loading, Stowage compartments**
Bag hook..... 122
Cargo tie-down rings..... 121
Coat hook..... 123
Definitions..... 387
Notes..... 113
Roof luggage rack..... 125
- Loading guidelines**..... 113
- Loading information table**..... 377
- Loads**..... 113
- Locator lighting**..... 138
- Locking/unlocking**
Automatic locking (MMS)..... 79, 80
Doors (from the inside)..... 77
Emergency key..... 80
KEYLESS-GO..... 78
- Loud sound**
PRE-SAFE® Sound..... 49
- Low-beam headlamps**
Activating/deactivating..... 133
- Lowering/raising the loading sill**..... 236
- Lowering/raising the rear of the vehicle**..... 236
- Lubricants**..... 407
- Luggage**..... 113
- Luggage rack**..... 113
- Lumbar support**..... 102
- M**
- MAGIC VISION CONTROL**
Windshield wiper..... 142
- Maintaining safe distance**
Active Distance Assist DISTRONIC..... 204
- Maintenance**
Vehicle..... 26
- Maintenance Management**
Notes..... 331
Transferred data..... 331
- Malfunction**
Driver display..... 272
Restraint system..... 44
- Malfunction message**
Driver's display..... 419
- Maneuvering**
Maneuvering brake function..... 262
- Maneuvering assistant**
Activating/deactivating..... 263
Drive Away Assist..... 260
Maneuvering brake function..... 262
- Maneuvering brake function**..... 262
- Manual gearshifting**
Activating/deactivating..... 178
- Map**
Displaying online map contents..... 305

- Displaying weather information..... 305
- Moving..... 304
- Selecting the map orientation..... 304
- Setting the map scale..... 304
- Map functions**..... 304
- Massage programs**..... 105, 106
- Maximum full-stop braking**..... 193
- Maximum permissible load**
 - Calculation example..... 379
 - Determining..... 378
- Maximum tire load**..... 383
- Maximum tire pressure**..... 384
- MBUX**
 - Dashcam..... 307
- MBUX Interior Assistant**
 - Overview..... 284
 - Reading light..... 286
 - Search light..... 286
- MBUX multimedia system**
 - Activating/deactivating DSR..... 211
 - Activating/deactivating standby mode... 190
 - Configuring display settings..... 277
 - Drive programs..... 173
- Factory setting..... 295
- Home screen..... 281
- Language settings..... 283
- MBUX Interior Assistant..... 284
- Media..... 323
- Mercedes me & Apps..... 317
- Notes..... 279
- Overview..... 280
- Set collision detection..... 188, 189
- Setting route-based speed adaptation.... 208
- Standby mode function..... 190
- Steering wheel heater / seat heating.... 110
- Telephone..... 309
- Touchscreen..... 281
- MBUX reading light**..... 286
- MBUX search light**..... 286
- MBUX Voice Assistant**
 - Function..... 283
 - Voice prompting..... 284
- Mechanical key**
 - Inserting/removing..... 75
- Media**
 - Overview of functions/symbols..... 323
- Medical aids**..... 33
- Memory function**
 - Head-up display..... 113
 - Outside mirrors..... 113
 - Seat..... 113
- Menus (driver's display)**
 - Notes..... 274
 - Sport..... 275
- Mercedes me App**
 - Activating on-demand features..... 26
- Mercedes me Apps**..... 317
- Mercedes me calls**
 - Arranging a service appointment..... 314
 - Calling the Mercedes-Benz customer center after automatic accident/breakdown detection..... 313
 - Information..... 312
 - Information..... 313
 - Mercedes-Benz customer center..... 313
 - Transferred data..... 315
- Mercedes me connect**
 - Accident/Breakdown Management..... 316
 - Information..... 316
 - Transferred data..... 317
- Mercedes-AMG vehicles, Notes**..... 155

Mercedes-Benz emergency call system,

Emergency call	
Automatic emergency call.....	320
Data transfer.....	322
Information.....	319
Manual emergency call.....	321
Overview.....	320

Mercedes-Benz GenuineParts.....	23
----------------------------------------	-----------

Message memory.....	419
----------------------------	------------

Mirrors

Mirror folding function.....	145
Outside mirrors.....	143
Rearview mirror.....	144

Mobile phone

Notes on wireless charging.....	129
---------------------------------	-----

Model type.....	405
------------------------	------------

Modification

Limited protection.....	53
-------------------------	----

Multifunction camera

ROAD SURFACE SCAN.....	239
------------------------	-----

Multimedia system.....	280
-------------------------------	------------

N**Navigation**

Activating.....	298
Destination entry.....	301
Notes.....	298
Overview.....	299

Neutral.....	175
---------------------	------------

Non-operational time

Activating/deactivating standby mode...	190
-----------------------------------------	-----

Notes on breaking in a new vehicle.....	158
------------------------------------------------	------------

O**Objects in the vehicle interior**

Limited protection.....	53
-------------------------	----

Occupant presence reminder

Activating/deactivating.....	72
Function.....	72

Occupant safety

Air bag.....	57
Basic information.....	41
Child seat.....	58
Information on the child restraint system.....	48

Information on the correct seat position...	42
---------------------------------------------	----

Occupant presence reminder.....	72
---------------------------------	----

Pets in the vehicle.....	53
--------------------------	----

PRE-SAFE®.....	49
----------------	----

Off-road ABS.....	193
--------------------------	------------

Off-road Assist

Setting.....	296
--------------	-----

Off-road driving

Driving tips.....	163
-------------------	-----

Off-road menu

Overview.....	295
Setting.....	296

Offroad Score

Displaying.....	297
-----------------	-----

On-board diagnostics interface.....	31
--------------------------------------------	-----------

On-board electronics

Two-way radios.....	403
---------------------	-----

On-demand feature.....	25, 26
-------------------------------	---------------

Online services.....	38
-----------------------------	-----------

Open Source Software.....	40
----------------------------------	-----------

Opening angle

Limiting (tailgate).....	86
--------------------------	----

- Opening the tailgate using your foot
HANDS-FREE ACCESS..... 84
- Opening/closing a door..... 186
- Opening/closing a garage door..... 186
- Operating fluids**
Additives..... 410
Brake fluid..... 411
coolant..... 411
Engine oil..... 410
Gasoline..... 409
Notes..... 407
Refrigerant (air conditioning system)..... 413
Windshield washer fluid..... 412
- Operating safety**
48 V on-board electrical system..... 27
- Operator's manual**..... 24
- Operator's Manual digital**..... 22
- Outside mirrors**
Automatic anti-glare mode..... 144
Automatic mirror folding function..... 145
Blind Spot Assist / Active Blind Spot Assist..... 227
Folding in/out..... 143
- Memory function..... 113
Setting..... 143
Warning lamp..... 227
- Overhead control panel**..... 14
- P**
- Paddle shifters**
Steering wheel paddle shifters..... 177
- Paint code**..... 405
- Panic alarm, Alarm**
Activating/deactivating..... 74
- Park position**
DIRECT SELECT lever..... 174
- Parking**
Active Parking Assist..... 255
PARKTRONIC..... 251
- Parking Assist**
Active Parking Assist..... 255
PARKTRONIC..... 251
- Parking Assist PARKTRONIC**
Activating/deactivating..... 254
Adjusting warning tones..... 255
Function..... 251
- Parking assistance systems**
Active Parking Assist..... 255
Drive Away Assist..... 260
Maneuvering brake function..... 262
PARKTRONIC..... 251
- Parking brake**..... 186
- Parking for an extended period**..... 190
- Parking lamp**..... 133
- Parking position**
Exterior mirrors..... 144
Storing the position of the front-passenger outside mirror using reverse gear..... 145
- PARKTRONIC**..... 251
- PASSENGER AIR BAG**
Status display, front passenger air bag.... 46
- Payload**
Calculation example..... 379
Determining the maximum..... 378
- Permitted towing methods**
Overview..... 361
- Personalization**..... 287
- Pets in the vehicle**..... 53

- Post-collision brake**..... 51
Power closing function
 Door..... 80
Power supply
 Start/stop button..... 155
 Switching on (start/stop button)..... 155
Power washer..... 340
PRE-SAFE®, Anticipatory occupant protection
 Function..... 49
 PRE-SAFE® Sound..... 49
 Reverting measures..... 50
PRE-SAFE® Impulse Side
 Function..... 50
 Inflating..... 52
PRE-SAFE® PLUS
 Backing up measures..... 50
 Function..... 50
Preventative occupant protection system
 49, 50
Profile..... 287
Programs..... 170
Protection
 Limited..... 53
Protection against collision
 Maneuvering brake function..... 262
Protection of the environment
 Driving style..... 23
Pulling away
 Hill Start Assist..... 198
 Optimized acceleration..... 159
Q
QR code rescue card..... 35
Qualified specialist workshop..... 32
R
Radar and ultrasonic sensors..... 191
Radio..... 325
Radio regulations
 Regulatory radio identification..... 405
Rain closing function
 Sliding sunroof..... 93
Rain sensor
 Sliding sunroof..... 93
 Windshield wipers..... 139
Reading lamp
 Interior lighting..... 138
Rear door (child safety lock)
 Securing..... 70
Rear fog light..... 134
Rear passenger compartment climate control..... 150
Rear passenger compartment seat belt
 Status display..... 45
Rear view camera
 360° Camera..... 242
 Function..... 242
 Opening the camera cover..... 251
Rear window heater..... 147
Rearview mirror
 Automatic anti-glare mode..... 144
Rearward-facing child seat
 Information..... 64
Reflective safety vest..... 348
Refrigerant..... 413

-
- Refueling**
 - Fuel..... 179
 - Refueling the vehicle..... 179
 - Regulatory radio information**
 - Specific absorption rate..... 405
 - Remote Online**
 - Charging the starter battery..... 157
 - Cooling/heating the vehicle interior..... 157
 - Starting the vehicle..... 158
 - Replacement key**..... 76
 - Reporting safety defects**..... 34
 - Reserve**
 - Fuel..... 410
 - Resetting**
 - MBUX reset function..... 295
 - Residual heat**..... 151
 - Responsibility**
 - Driving safety systems..... 190
 - Restraint system**
 - Basic information..... 41
 - Basic instructions for children..... 58
 - Deployment situations..... 52
 - Functionality..... 44
 - Information on function..... 52
 - Information on the correct seat position... 42
 - Limited protection..... 53
 - Malfunction..... 44
 - Protection..... 42
 - Self-test..... 44
 - Warning lamp..... 44
 - Reverse gear**
 - DIRECT SELECT lever..... 174
 - Reversing camera**
 - Activating via GPS..... 251
 - Managing activation points..... 251
 - ROAD SURFACE SCAN**..... 239
 - Roadside Assistance (breakdown)**..... 26
 - Roll away protection**..... 197
 - Roller sunblind**
 - Sliding sunroof..... 90
 - Rollover crash**..... 32
 - Roof load**..... 415
 - Roof load display**
 - Information..... 172
 - Roof luggage rack**
 - Loading..... 125
 - Securing**..... 125
 - Route**
 - Alternative route..... 302
 - Calculating..... 302
 - Commuter route..... 302
 - Navigation..... 299
 - Selecting a type..... 302
 - Route guidance with augmented reality**
 - Activating..... 302
 - Displaying road names/house numbers..... 302
 - Switching video on or off..... 302
 - Route-based speed adaptation**
 - Function..... 207
 - Setting..... 208
 - Running boards**
 - Care..... 343
- S**
- Safety system**..... 192
 - Satellite radio**
 - Logging in..... 328
 - Setting music and sport alerts..... 328

- Seat, Through-loading feature**
 Adjusting electrically..... 99
 Automatic adjustment..... 105
 Configuring settings..... 104
 Correct driver's seat position..... 98
 Folding back the backrest (rear passenger compartment)..... 119
 Folding backrest forward (rear)..... 117
 Lumbar support..... 102
 Massage programs..... 105
 Memory function..... 113
 Resetting settings (massage programs).. 106
 Settings..... 16
 Side impact air bag..... 57
 Workout programs..... 105
- Seat (rear passenger compartment)**
 Settings..... 18
- Seat belt**
 Automatic tightening..... 51
 Care..... 345
 Rear passenger compartment seat belt status display..... 45
 Warning lamp..... 45
- Seat belt adjustment**
 Activating/deactivating..... 51
 Function..... 51
- Seat belt warning**..... 45
- Seat belts**
 Activating/deactivating seat belt adjustment..... 51
 Fastening..... 44
 Notes on wearing correctly..... 43
 Releasing..... 57
 To adjust the height..... 44
- Seat heating**
 Activating/deactivating..... 106
- Seat ventilation**
 Activating/deactivating..... 108
- Selecting a gear**..... 177
- Selector lever**..... 174
- Self-test**
 Automatic front passenger air bag shutoff..... 46
 Restraint system..... 44
- Sensors**
 Cleaning..... 343
 Information..... 191
- Service**..... 330
- Service center**..... 32
- Service due date**..... 330
- Service interval display**..... 330
- Shifting**
 Automatic transmission..... 177
 Gearshift recommendation..... 178
 Manual..... 177
 Steering wheel paddle shifters..... 177
- Shortening the braking distance**
 Brake Assist System..... 193
- Shunting assistant**..... 263
- Shunting support**..... 261
- Side impact air bag**..... 57
- Side window**
 Window films..... 343
- Side windows**
 Child safety lock (rear passenger compartment)..... 72
 Closing with SmartKey..... 89
 Convenience closing feature..... 89
 Convenience opening..... 88
 Opening with the SmartKey..... 88
 Opening/closing..... 87





- Problem..... 89
- Size designation**
- Tires..... 384
- Skid chains**..... 371
- Sliding sunroof**, Panorama roof with power tilt/sliding panel
 - Automatic functions..... 93
 - Closing with SmartKey..... 89
 - Opening with the SmartKey..... 88
 - Opening/closing..... 90
 - Problem..... 94
 - Rain closing function..... 93
- SmartKey**
 - Acoustic locking verification signal..... 74
 - Battery..... 75
 - Deactivating a function..... 74
 - Function..... 73
 - Key ring attachment..... 75
 - Mechanical key..... 75
 - Panic alarm..... 74
 - Power consumption..... 74
 - Unlocking setting..... 74
- Smartphone Integration**, iPhone®
 - Android Auto..... 318
- Apple CarPlay®..... 318
- Snow chains**..... 371
- Socket**
 - 12 V..... 128
 - 115 V (rear passenger compartment)..... 128
- Software update**..... 291
- SOS button**..... 312
- Sound**
 - Menu..... 329
 - PRE-SAFE® Sound..... 49
 - Wheels/tires..... 370
- Sound settings**..... 329
- Spare parts**..... 23
- Spare wheel**..... 398
- Special seat belt retractor**..... 66
- Specialist workshop**..... 32
- Specific absorption rate (SAR)**..... 405
- Speed**
 - Save, cruise control..... 204
 - Save, DISTRONIC..... 204
- Speed adaptation**, Route-based..... 207
- Speed control**
 - Active Distance Assist DISTRONIC..... 202
 - Cruise control..... 200
- Speed rating**
 - Tires..... 384
- Sport Utility Vehicle**..... 32
- Start-off assist**
 - Hill Start Assist..... 198
 - Optimized acceleration..... 159
- Start/stop button**
 - Parking the vehicle..... 182
 - Starting the vehicle..... 156
 - Switching on the power supply / vehicle..... 155
- Start/stop function**..... 166
- Starter battery**
 - charging, Remote Online..... 157
- Starting**
 - Remote Online..... 158
 - Start/stop button..... 156
- Starting assistance**..... 359
- Starting the engine**
 - Emergency operation mode..... 157































- Remote Online..... 158
 Start/stop button..... 156
- Starting-off aid**
 Drive Away Assist..... 260
 Hill Start Assist..... 198
 Optimized acceleration..... 159
- Status display**
 Front passenger air bag..... 46
 Rear passenger compartment seat belt.... 45
- Steer Assist**
 Active Steering Assist..... 212
 STEER CONTROL..... 196
- STEER CONTROL**..... 196
- Steering wheel**
 Adjusting electrically..... 109
 Driver's air bag..... 57
 Manually adjusting..... 108
 Steering wheel heater..... 110
- Steering wheel adjustments**..... 109
- Steering wheel heater**..... 110
- Steering wheel heating**
 Decoupling from the seat heating..... 110
- Steering wheel paddle shifters**..... 177
- Stop and go**
 ECO start/stop function..... 167
- Stopping**
 Parking the vehicle..... 182
- Stowage areas**..... 117
- Stowage spaces**
 Armrest (front)..... 117
 Center console (front)..... 117
 Door..... 117
 Glove box..... 117
- Substances hazardous to health**..... 27
- Sulfur content**..... 409
- Suspension**
 Adjusting the vehicle level (E-ACTIVE BODY CONTROL)..... 241
 AIRMATIC..... 233
 E-ACTIVE BODY CONTROL..... 237
 Individual wheel control (E-ACTIVE BODY CONTROL)..... 240
 Rocking free mode (E-ACTIVE BODY CONTROL)..... 240
 Setting entering/exiting level (AIR-MATIC)..... 236
 Setting the suspension level (AIR-MATIC)..... 234
- Switch-off delay time**
 Exterior..... 137
 Interior..... 139
- Switching air-recirculation mode on/off**..... 150
- Synchronization function**
 Activating/deactivating (control panel)... 150
- System settings**
 MBUX reset function..... 295
 Overview..... 290
- T**
- Tailgate, Trunk lid**
 Closing..... 82
 Emergency key..... 87
 HANDS-FREE ACCESS..... 84
 Limiting the opening angle..... 86
 Opening..... 81
 Opening dimensions..... 414
- Tank capacity**
 Fuel..... 410
 Reserve..... 410

- Tank filler cap / flap..... 179
- Technical data**
 - Information..... 403
 - Radio regulations..... 405
 - Roof load..... 415
 - Specific absorption rate (SAR)..... 405
 - Tongue weight..... 417
 - Towing capacity..... 417
- Telediagnosis**
 - Diagnostic data..... 331
- Telediagnosics**
 - Transferred data..... 332
- Telephone, Smartphone**
 - Bluetooth®..... 311
 - Charging wirelessly (mobile phone)..... 131
 - Connecting a mobile phone..... 311
 - Menu..... 312
 - Notes..... 309
 - Notes on wireless charging (mobile phone)..... 129
 - Operating modes..... 311
 - Secure Simple Pairing..... 311
 - Telephone menu overview..... 311
- Telephony operating modes**
 - Bluetooth® telephony..... 311
- Temperature**
 - Setting the vehicle interior temperature..... 147
- Temperature grade**..... 381
- TIN (Tire Identification Number)**..... 382
- Tire and Loading Information placard**..... 377
- Tire information table**..... 377
- Tire labeling**
 - Load index..... 384
 - Load-bearing capacity..... 384
 - Size designation..... 384
 - Speed rating..... 384
 - Temperature grade..... 381
 - Tire Quality Grading..... 381
 - Traction grade..... 381
 - Tread wear grade..... 381
- Tire lettering**
 - Composition..... 384
 - DOT, Tire Identification Number (TIN)..... 382
 - Maximum tire load..... 383
 - Maximum tire pressure..... 384
- Tire pressure**
 - Checking..... 375
 - Checking manually..... 374
 - maximum..... 384
 - Notes..... 371
 - Tire pressure table..... 373
 - TIREFIT kit..... 351
- Tire pressure monitor**
 - Function..... 374
- Tire pressure monitoring system**
 - Restarting..... 376
- Tire pressure table**..... 373
- Tire Quality Grading**..... 381
- Tire sealant**..... 351
- Tire tread**..... 370
- Tire-change tool**..... 392
- Tire-change tool kit**..... 392
- TIREFIT kit, Tire inflation compressor**
 - Storage location..... 350
- Tires**
 - Breakdown..... 350
 - Checking..... 370
 - Checking the temperature..... 375

- Checking the tire pressure manually..... 374
- Composition..... 384
- Definitions..... 387
- DOT, Tire Identification Number (TIN)..... 382
- Installing..... 396
- Labeling..... 381
- Load index..... 384
- Load-bearing capacity..... 384
- Maximum pressure..... 384
- Maximum tire load..... 383
- Noise..... 370
- Notes on installing..... 389
- Removing..... 396
- Removing/installing hub cap..... 393
- Replacing..... 389, 393
- Rotating..... 392
- Selecting..... 389
- Size designation..... 384
- Snow chains..... 371
- Speed rating..... 384
- Storing..... 392
- Temperature grade..... 381
- Tire and Loading Information placard..... 377
- Tire pressure table..... 373
- Tire Quality Grading..... 381
- TIREFIT kit..... 351
- Traction grade..... 381
- Tread wear grade..... 381
- Unusual handling characteristics..... 370
- Toll system**
 - Debiting toll fees..... 299
 - Windshield..... 146
- Tongue weight**..... 417
- Top Tether**..... 68
- Torque (driver's display)**..... 275
- Touch Control**
 - Driver display..... 272
 - Driver's display..... 273
 - MBUX..... 281
- Touch-sensitive controls**..... 25
- Touchscreen**..... 281
- Tow bar system**
 - Towing away..... 271
- Tow-away protection**..... 96
- Tow-starting**..... 366
- Towing**
 - Towing methods..... 361
- Towing a trailer**
 - Active Lane Keeping Assist..... 230
 - Notes..... 266
- Towing eye**
 - Storage location..... 365
- Towing methods**
 - Both axles on the ground..... 362
 - Overview..... 361
- Traction grade**..... 381
- Traffic information**..... 305
- Traffic Jam Assistant**..... 209
- Traffic light warning/display**..... 223
- Traffic Sign Assist**
 - Function..... 223
 - Setting..... 227
- Trailer drawbar, Pulling/towing**..... 271
- Trailer hitch**
 - Attaching the ball neck..... 268
 - Care..... 343
 - Coupling up/uncoupling a trailer..... 268
 - General notes..... 417
 - Tongue weight..... 417
 - Towing capacity..... 417

- Trailer Maneuvering Assist..... 263
- Trailer Maneuvering Assist**
- Function..... 263
- Using..... 265
- Trailer operation**
- Active Blind Spot Assist..... 229
- Attaching the ball neck..... 268
- Coupling up/uncoupling a trailer..... 268
- Setting..... 270
- Trailer stabilization**..... 195
- Transmission position display**..... 174
- Transmission positions**
- DIRECT SELECT lever..... 174
- Transporting**
- Vehicle..... 364
- Tread wear grade**..... 381
- TuneIn Internet Radio**..... 327
- Turn signal indicator**..... 134
- Turn signals**..... 134
- Two-way radios**
- Frequencies..... 404
- Installation..... 403
- Transmission output..... 404
- U**
- Unfastening**..... 57
- Unlocking setting**..... 74
- Updates**..... 291
- USB port**
- Storage compartments (front)..... 117
- User profiles**
- Adding a user..... 289
- Note..... 287
- Selecting options..... 289
- V**
- Vehicle, Switching on the ignition**
- 48 V on-board electrical system..... 27
- Activating, Remote Online..... 158
- Activating/deactivating standby mode... 190
- Correct use..... 32
- Data storage..... 35
- Diagnostics connection..... 31
- Emergency key..... 80
- Equipment..... 24
- KEYLESS-GO..... 78
- Limited Warranty..... 35
- lock automatically (MMS)..... 79, 80
- Locking/unlocking (emergency key)..... 80
- Locking/unlocking (from inside)..... 77
- Lowering..... 397
- Maintenance..... 26
- Medical aids..... 33
- Parking..... 182
- Parking for an extended period..... 190
- Problem notification..... 34
- Pulling..... 271
- QR code rescue card..... 35
- Raising..... 394
- Set collision detection..... 188, 189
- Standby mode function..... 190
- Starting (start/stop button)..... 156
- starting, emergency operation mode..... 157
- Stopping..... 182
- Switching off (start/stop button)..... 182
- Switching on (start/stop button)..... 155
- Towing away..... 361
- Transporting..... 364
- Ventilating / comfort opening..... 88
- Vehicle cameras**..... 191

- Vehicle data**
- Angle of approach/departure..... 416
 - Display, MBUX..... 173
 - Displaying, DYNAMIC SELECT..... 173
 - Fording depth..... 416
 - Maximum gradient-climbing capability.... 416
 - Roof load..... 415
 - Turning radius..... 414
 - Vehicle height..... 414
 - Vehicle length..... 414
 - Vehicle width..... 414
 - Wheelbase..... 414
- Vehicle dimensions**..... 414
- Vehicle emergency start**..... 366
- Vehicle equipment**..... 24
- Vehicle identification number**..... 405
- Vehicle identification plate**
- Model type..... 405
 - Paint code..... 405
 - VIN..... 405
- Vehicle interior**
- Cooling/heating (Remote Online)..... 157
- Vehicle key**..... 73
- Vehicle level**
- AIRMATIC..... 233
 - Lowering/raising the rear end of the vehicle (AIRMATIC)..... 236
 - Setting (AIRMATIC)..... 234
 - Setting (E-ACTIVE BODY CONTROL)..... 241
 - Setting entering/exiting level (AIR-MATIC)..... 236
 - Setting individual wheel control..... 296
- Vehicle operation outside the USA or Canada**..... 26
- Vehicle sensors**..... 191
- Vehicle start**
- Emergency operation mode..... 157
 - Remote Online..... 158
 - Start/stop button..... 156
- Vehicle tool kit**
- TIREFIT kit..... 350
 - Towing eye..... 365
- Vehicle with a high center of gravity**..... 32
- Ventilating**..... 88
- Ventilation**..... 153
- Vents**
- Air vents..... 153
- VIN**
- Engine compartment..... 405
 - Identification plate..... 405
 - Seat..... 405
- Vision**
- Defrosting windows..... 150
- Voice assistant**
- Voice prompting..... 284
- W**
- Warning system**..... 95
- Warning triangle**..... 349
- Warning/indicator lamp**
-  ABS warning lamp..... 488
 -  Active Brake Assist warning lamp..... 491
 -  ATTENTION ASSIST warning lamp..... 490
 -  Brakes warning lamp (Canada only)..... 487

-  Brakes warning lamp (USA only)... 487
-  Brakes warning lamp (yellow) (Canada only)..... 486
-  Check Engine warning lamp..... 483
-  Coolant warning lamp (red)..... 481
-  Coolant warning lamp (yellow)..... 483
-  Distance warning lamp..... 490
-  Electric parking brake indicator lamp (red) (Canada only)..... 485
-  Electric parking brake indicator lamp (red) (USA only)..... 485
-  Electric parking brake indicator lamp (yellow)..... 485
-  Electrical malfunction warning lamp..... 483
-  Engine operating temperature warning lamp..... 484
-  ESP® OFF warning lamp..... 489
-  ESP® warning lamp flashes..... 488
-  ESP® warning lamp lights up..... 489
-  Fuel reserve warning lamp flashes..... 484
-  Fuel reserve warning lamp lights up..... 484
-  Mercedes-Benz emergency call system warning lamp..... 493
-  Occupant presence reminder warning lamp (white)..... 479
-  Occupant presence reminder warning lamp (yellow)..... 479
-  Power steering warning lamp (red)..... 480
-  Power steering warning lamp (yellow)..... 480
-  RBS warning lamp (USA only)..... 486
-  Reduced warning lamp power..... 480
-  Restraint system warning lamp..... 478
-  Seat belt warning lamp flashes.... 478
-  Seat belt warning lamp lights up... 479
-  Suspension warning lamp (red).... 492
-  Suspension warning lamp (yellow)..... 491, 492
-  Tire pressure monitoring system warning lamp flashes..... 493
-  Tire pressure monitoring system warning lamp lights up..... 494
-  Traffic Sign Assist warning lamp... 490
- Warning/indicator lamps**
- Driver's display..... 476
 - PASSENGER AIR BAG..... 46
- Washer fluid**
- Topping up..... 337
 - Windshield washer fluid..... 412
- Washing by hand**..... 341
- Water tank**..... 338
- Wear**
- Limited protection..... 53
- Weather information**..... 305
- Web browser**..... 318
- Weight information**..... 405

- Wheel change**
Installing a new wheel..... 396
Lowering the vehicle..... 397
Removing a wheel..... 396
Removing/installing hub caps..... 393
- Wheel rotation**..... 392
- Wheels**
Breakdown..... 350
Care..... 343
Checking..... 370
Checking the tire pressure manually..... 374
Checking the tire temperature..... 375
Composition of the tire..... 384
Definitions..... 387
DOT, Tire Identification Number (TIN)..... 382
Installing..... 396
Load index..... 384
Load-bearing capacity..... 384
Maximum tire load..... 383
Maximum tire pressure..... 384
Noise..... 370
Notes on installing..... 389
Removing..... 396
Removing/installing hub cap..... 393
Replacing..... 389, 393
- Rotating..... 392
Selecting..... 389
Size designation..... 384
Snow chains..... 371
Speed rating..... 384
Storing..... 392
Temperature grade..... 381
Tire and Loading Information placard..... 377
Tire labeling..... 381
Tire pressure..... 371
Tire pressure monitor..... 374
Tire Quality Grading..... 381
TIREFIT kit..... 351
Traction grade..... 381
Tread wear grade..... 381
Unusual handling characteristics..... 370
- Wi-Fi**
Setting up a hotspot..... 292
- Window curtain air bag**..... 57
- Windows**
Care..... 343
Convenience opening..... 88
De-icing..... 148
Opening with the SmartKey..... 88
Opening/closing..... 87
- Removing mist..... 150
Window films..... 343
- Windshield**
De-icing..... 148
Defrosting..... 147
Infrared reflective..... 146
Radio waves..... 146
Replacing the wiper blades with
MAGIC VISION CONTROL..... 142
Toll system..... 146
- Windshield washer fluid**..... 412
- Windshield washer system**..... 337
- Windshield wiper**
Replacing the wiper blades with
MAGIC VISION CONTROL..... 142
- Windshield wipers**
Activating/deactivating..... 139
Replacing the wiper blades..... 140
Replacing the wiper blades (wind-
shield)..... 140
- Winter operation**
Snow chains..... 371

Wiper blades

- Care..... 343
- Replacing (windshield)..... 140
- Replacing with MAGIC VISION CON-
TROL..... 142

Wipers..... 139**Wireless charging**

- Mobile phone..... 131
- Notes..... 129

Workout programs..... 105**Workshop**..... 32

