



Digital – in the vehicle

Explore the Operator's Manual in the multimedia system under Preferences. Begin with Quick Start and discover useful tips.



Vehicle document wallet

This contains a physical copy of comprehensive information about operating your vehicle and about services and your vehicle's warranty



1185843611

Order no. P118 0824 13 Part no. 118 584 36 11
Edition B-2025

CLA

Mercedes-Benz



CLA

Operator's Manual

Mercedes-Benz



Front passenger air bag warning

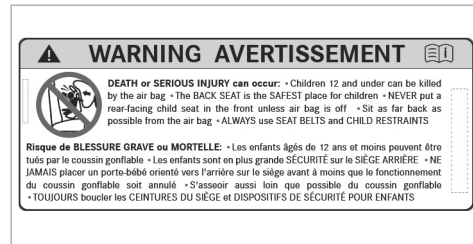
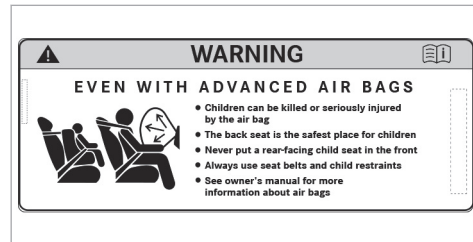

Air bag warning sticker for USA and Canada

WARNING Risk of injury or fatal injuries if the front passenger air bag is enabled

If the front passenger air bag is enabled, a child on the front passenger seat may be struck by the front passenger air bag in the event of an accident.

▶ NEVER use a rearward-facing child restraint system on a seat with an ENABLED FRONT AIR BAG. This can result in the DEATH of or SERIOUS INJURY to the CHILD.

Observe the chapter "Children in the vehicle".

Publication details

Website

Further information about Mercedes-Benz vehicles and about Mercedes-Benz AG can be found on the following websites:

<https://www.mbusa.com> (USA only)

<https://www.mercedes-benz.ca> (Canada only)

Editorial team

© Mercedes-Benz AG: Not to be reprinted, translated or otherwise reproduced, in whole or in part, without written permission from Mercedes-Benz AG.

Vehicle manufacturer

Mercedes-Benz AG

Mercedesstraße 120

70372 Stuttgart, Germany

Welcome to the world of Mercedes-Benz

Before your first drive, please read this Operator's Manual carefully and familiarize yourself with your vehicle. For your own safety and a longer service life for the vehicle, follow the instructions and warning notes in this Operator's Manual. Failure to do so may lead to personal injury or damage to the vehicle.

Vehicle damage caused by failure to observe the instructions is not covered by the Mercedes-Benz Limited Warranty.

The standard equipment and product description of your vehicle may vary and depends on the following factors:

- Model
- Order
- National version
- Availability

In individual cases, your vehicle may therefore differ from that shown in the descriptions and illustrations.

Mercedes-Benz reserves the right to introduce changes in the following areas:

- Design
- Equipment
- Technical features

The following documents are components of the vehicle:

- Digital Operator's Manual
- Printed Operator's Manual
- Maintenance Booklet (USA only)
- Supplementary manuals relating to specific equipment
- Supplementary documents

Keep these documents in the vehicle at all times. Ensure that all documents are in the vehicle or passed on in the event of sale or rental.

The latest information on service and warranty, along with a digital copy of this Operator's Manual, can be found on the following website.

USA only:

<https://www.mbusa.com/en/vehicle-information>

Canada only:

<https://www.mercedes-benz.ca/en/owners/manuals> (English)

<https://www.mercedes-benz.ca/fr/owners/manuals> (French)

Mercedes-Benz USA, LLC

Mercedes-Benz Canada, Inc.

A Mercedes-Benz Group AG Company

Symbols	5	Installing the license plate on the front license plate bracket	30	Children in the vehicle	58
At a glance	6	Country-specific information for regulatory radio components	30	Key facts in brief	58
Cockpit	6	Diagnostics connection	31	Important safety notes	58
Indicator and warning lamps (standard)	8	Qualified specialist workshop	32	Suitable child restraint systems for the transport of children	64
Indicator and warning lamps (widescreen cockpit)	12	Correct use of the vehicle	32	Securing the child restraint system	64
Overhead control panel	16	Notes for persons with electronic medical aids	33	Child safety locks	71
Door control panel and seat adjustment	18	Problems with your vehicle	33	Occupant presence reminder	72
Emergencies and breakdowns	20	Reporting safety defects	33	Opening and closing	74
Digital Operator's Manual	22	Limited Warranty	34	SmartKey	74
Calling up the Digital Operator's Manual	22	QR code for rescue card	34	Doors	78
General notes	23	Data storage	35	Trunk	82
Protection of the environment	23	Copyright	39	Side windows	86
Mercedes-Benz GenuineParts	23	Occupant safety	41	Sliding sunroof	90
Operator's Manual	24	Brief overview of the most important points	41	Anti-theft protection	94
Touch-sensitive controls	25	Information on the automatic functions of the restraint system	48	Seats and stowing	97
Mercedes me App	25	Purpose and function of the restraint system	51	Notes on the correct driver's seat position ...	97
Service and vehicle operation	26	Seat belts	56	Notes on grab handles	98
Operating safety	27	Airbags	57	Seats	98
				Steering wheel	108
				Easy entry and exit feature	109
				Memory function	111

Stowage areas	112	Parking	164	Maintenance and care	281
Sockets	120	Driving and driving safety systems	172	ASSYST PLUS service interval display	281
Wireless charging of the mobile phone and connection with the exterior antenna	122	Vehicle towing instructions	226	Maintenance Management	282
Installing/removing the floor mats	124			Telediagnosis	282
Light and visibility	125	Driver's display	227	Engine compartment	283
Exterior lighting	125	Notes on the driver display	227	Checking the brake lining thickness	289
Interior lighting	130	Driver display malfunction	227	Cleaning and care	290
Windshield wiper and windshield washer system	131	Operating the driver display	228		
Mirrors	134	Driver display menus	229	Breakdown assistance	299
		Head-up Display	230	Emergency	299
Climate control	137	Vehicles with a 48 V on-board electrical system	232	Flat tire	301
Overview of climate control systems	137	Overview of status indicators on the driver display	232	Battery (vehicle)	307
Operating the climate control system	137			Tow starting or towing away	313
		MBUX multimedia system	234	Electrical fuses	318
Driving and parking	141	Overview and operation	234		
Driving	141	System settings	244	Wheels and tires	321
DYNAMIC SELECT	153	Navigation and traffic	249	Notes on noise or unusual handling char- acteristics	321
Automatic transmission	156	Telephone	261	Notes on regularly inspecting wheels and tires	321
Function of 4MATIC	161	Mercedes me Apps	264	Notes on snow chains	322
Refueling	161	Mercedes-Benz emergency call system	271	Tire pressure	322
		Radio & media	274	Loading the vehicle	328
		Sound settings	280	Tire labeling	332

4 Contents

Definition of terms for tires and loading	338
Changing a wheel	340
Emergency spare wheel	349

Technical data	352
Notes on technical data	352
Vehicle electronics	352
Radio regulations	354
Vehicle identification plate, VIN and engine number overview	354
Operating fluids	356
Vehicle data	363

Display messages and warning/indicator lamps	364
Display messages	364
Warning and indicator lamps	415

Index	434
--------------------	------------

In this Operator's Manual, you will find the following symbols:

 **WARNING** Danger due to failure to observe the warning notices

Warning notices draw your attention to hazards that may endanger your health or life, or the health or life of others.

 Observe the warning notices.

 **ENVIRONMENTAL NOTE** Environmental damage due to failure to observe environmental notes

Environmental notes include information on environmentally responsible behavior or environmentally responsible disposal.

 Observe environmental notes.

 **NOTE** Damage to property due to failure to observe notes on material damage

Notes on material damage inform you of risks which may lead to your vehicle being damaged.

 Observe notes on material damage.

 These symbols indicate useful instructions or further information that could be helpful to you.

 Instruction

(→ page) Further information on a topic

Display Display in the central display





 Highest menu level, which is to be selected in the multimedia system

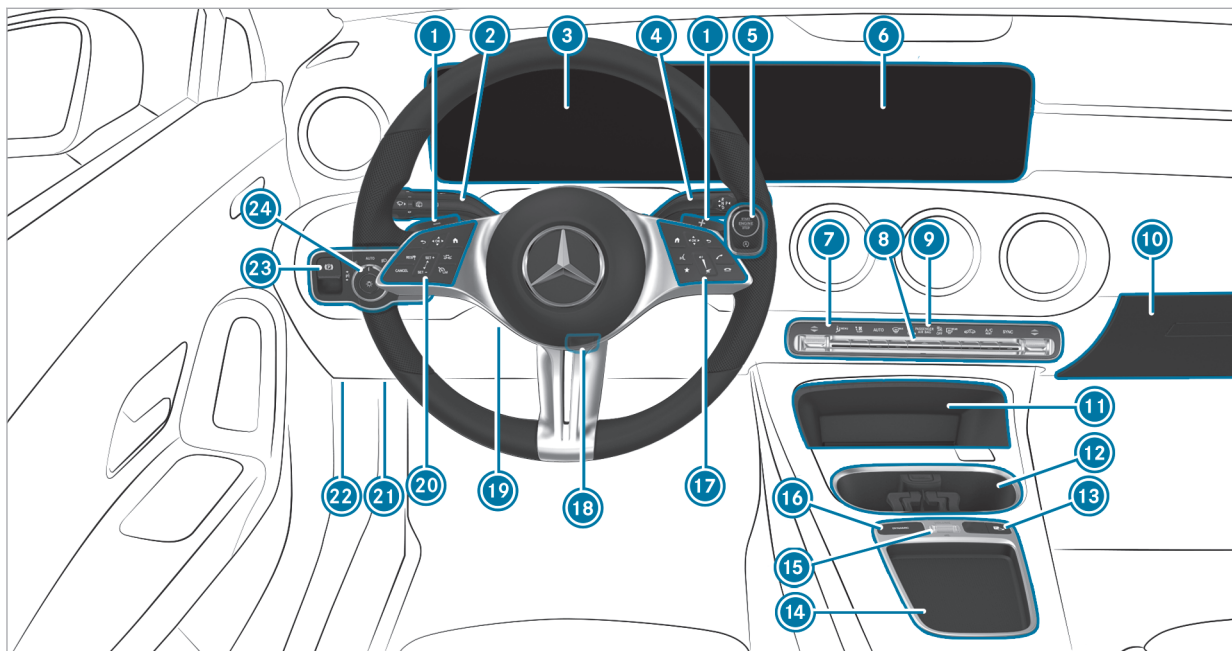



 Relevant submenus, which are to be selected in the multimedia system

* Indicates a cause



Left-hand drive vehicles







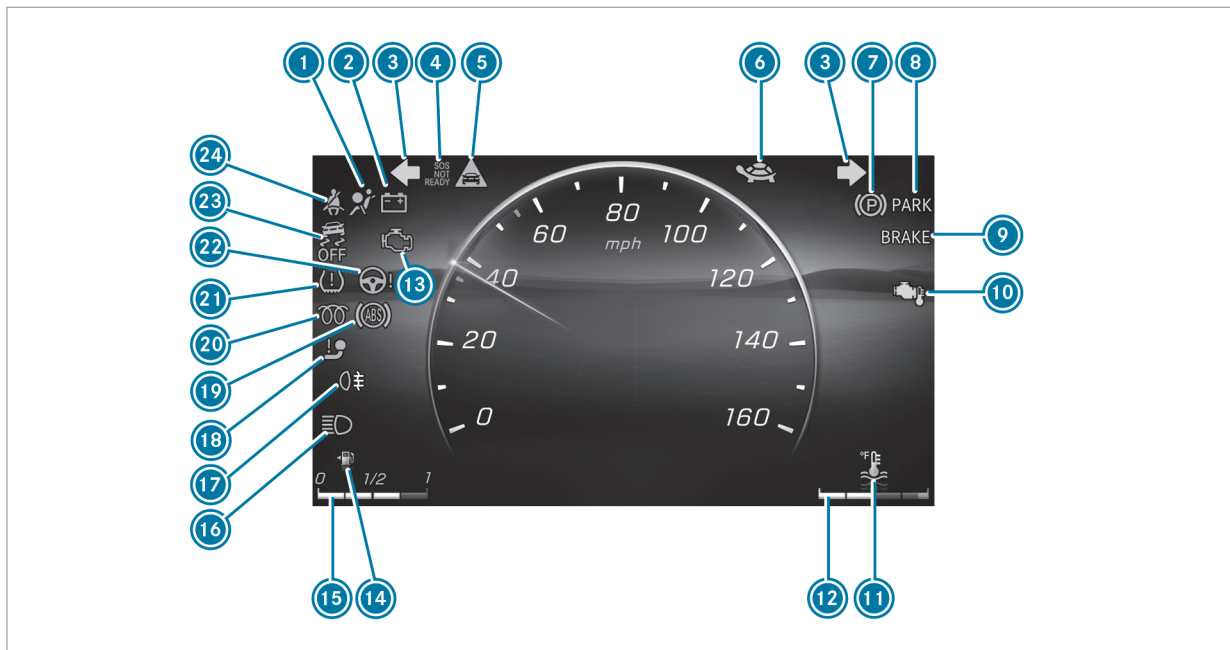

















①	Steering wheel paddle shifters	→	159
②	Combination switch	→	126
③	Driver display	→	232
④	DIRECT SELECT lever	→	156
⑤	 Start/stop button	→	142
	 ECO start/stop function	→	150
⑥	Central display	→	235
⑦	Climate control systems	→	137
⑧	 Hazard warning light system	→	127
⑨	PASSENGER AIR BAG indicator lamp	→	46
⑩	Glove box	→	115
⑪	Storage compartment	→	115
⑫	Cup holder		
⑬	 Active Parking Assist	→	220
⑭	Stowage space		
⑮	 Controller for volume and switching sound on/off	→	235

	 Switches the MBUX multimedia system on/off	→	235
⑯	DYNAMIC SELECT button	→	154
⑰	Control panel for the MBUX multimedia system	→	235
⑱	Adjusts the steering wheel	→	108
⑲	 Switches the steering wheel heater on/off	→	109
⑳	Control panel:		
	Driver display	→	232
	Cruise control	→	182
	 Active Distance Assist DISTRONIC	→	186
㉑	Diagnostics connection	→	31
㉒	Opens the hood	→	283
㉓	 Electric parking brake	→	168
㉔	Light switch	→	125

8 At a glance - Indicator and warning lamps (standard)



Standard driver display

①		Restraint system	→	418	⑪		Coolant temperature	→	421
②		Electrical malfunction	→	421	⑫		Coolant temperature display		
③		Turn signal lights	→	126	⑬		Engine diagnostics	→	421
④		Mercedes-Benz emergency call system	→	431	⑭		Reserve fuel with fuel filler flap location indicator	→	421
⑤		Distance warning	→	428	⑮		Fuel level		
⑥		Drive system: reduced power	→	420	⑯		High beam	→	126
⑦		Electric parking brake (yellow)	→	425			Low beam	→	125
⑧		Electric parking brake (red)	→	425			Side lights	→	125
	PARK	USA only			⑰		Rear fog light	→	126
		Canada only			⑱		Indicator lamp inoperative		
⑨		Brakes (red)	→	425	⑲		ABS	→	428
	BRAKE	USA only			⑳		Indicator lamp inoperative		
		Canada only			㉑		Tire pressure monitor	→	432
	RBS	Recuperative Brake System, USA only	→	425	㉒		Power steering (yellow)	→	420
		Brakes (yellow), Canada only	→	425			Power steering (red)	→	420
⑩		Gasoline engine: engine operating temperature	→	421	㉓		ESP® OFF	→	428

10 At a glance - Indicator and warning lamps (standard)

 ESP®



428





Seat belt



418



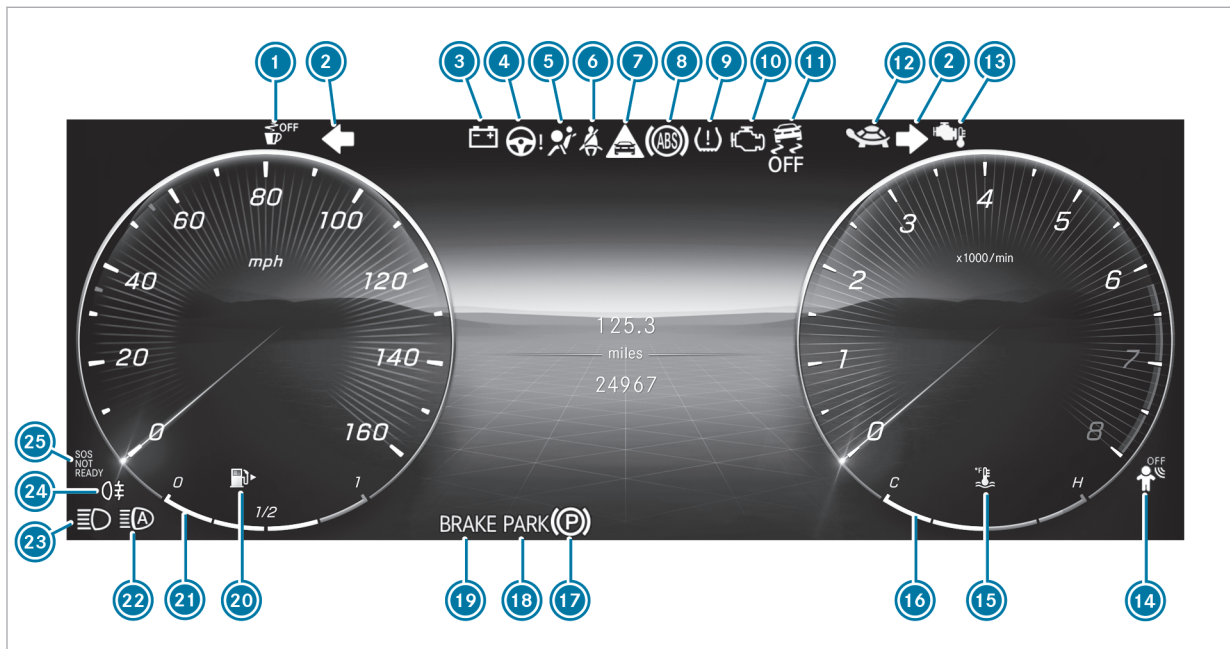

12 At a glance - Indicator and warning lamps (widescreen cockpit)



Driver display

1		ATTENTION ASSIST	→	428	14		Occupant presence reminder (white)	→	418
2		Turn signal lights	→	126			Occupant presence reminder (yellow)		
3		Electrical malfunction	→	421	15		Coolant temperature	→	421
4		Power steering (red)	→	420	16		Coolant temperature display		
		Power steering (yellow)	→	420	17		Electric parking brake (yellow)	→	425
5		Restraint system	→	418	18		Electric parking brake (red)	→	425
6		Seat belt	→	418			USA only		
7		Distance warning	→	428			Canada only		
8		ABS	→	428	19		Brakes (red)	→	425
9		Tire pressure monitor	→	432			USA only		
10		Engine diagnostics	→	421			Canada only		
11		ESP® OFF	→	428			Recuperative Brake System, USA only	→	425
		ESP®	→	428			Brakes (yellow), Canada only	→	425
12		Drive system: reduced power	→	420	20		Reserve fuel with fuel filler flap location indicator		
13		Gasoline engine: engine operating temperature	→	421	21		Fuel level		
					22		Adaptive Highbeam Assist	→	129







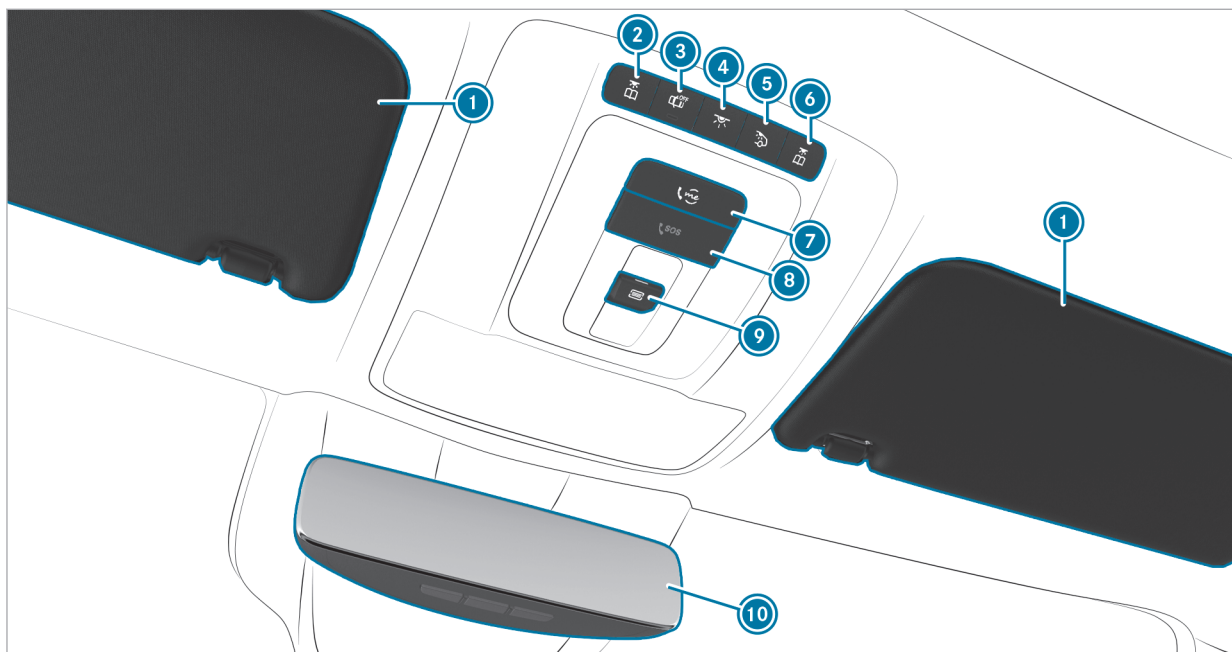

14 At a glance - Indicator and warning lamps (widescreen cockpit)

23		High beam	→	126
		Low beam	→	125
		Side lights	→	125









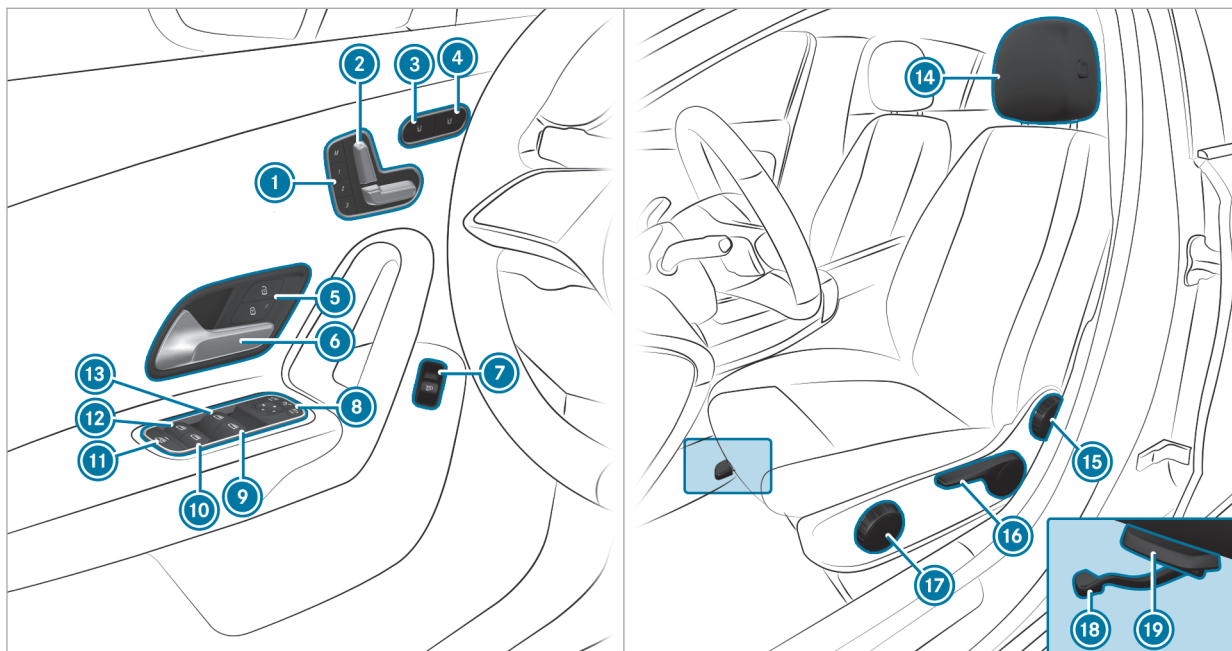



24		Rear fog light	→	126
25		Mercedes-Benz emergency call system	→	431









1	Sun visors		
2	 Switches the left-hand reading lamp on/off	→	130
3	 Switches automatic interior lighting control on/off	→	130
4	 Switches the front interior lighting on/off	→	130
5	 Switches the rear interior lighting on/off	→	130
6	 Switches the right-hand reading lamp on/off	→	130
7	 me button	→	264
8	 SOS button	→	264
9	 Opens/closes the panorama roof with power tilt/sliding panel	→	90
	 Opens/closes the roller sunblind	→	90
10	Inside rear-view mirror	→	135

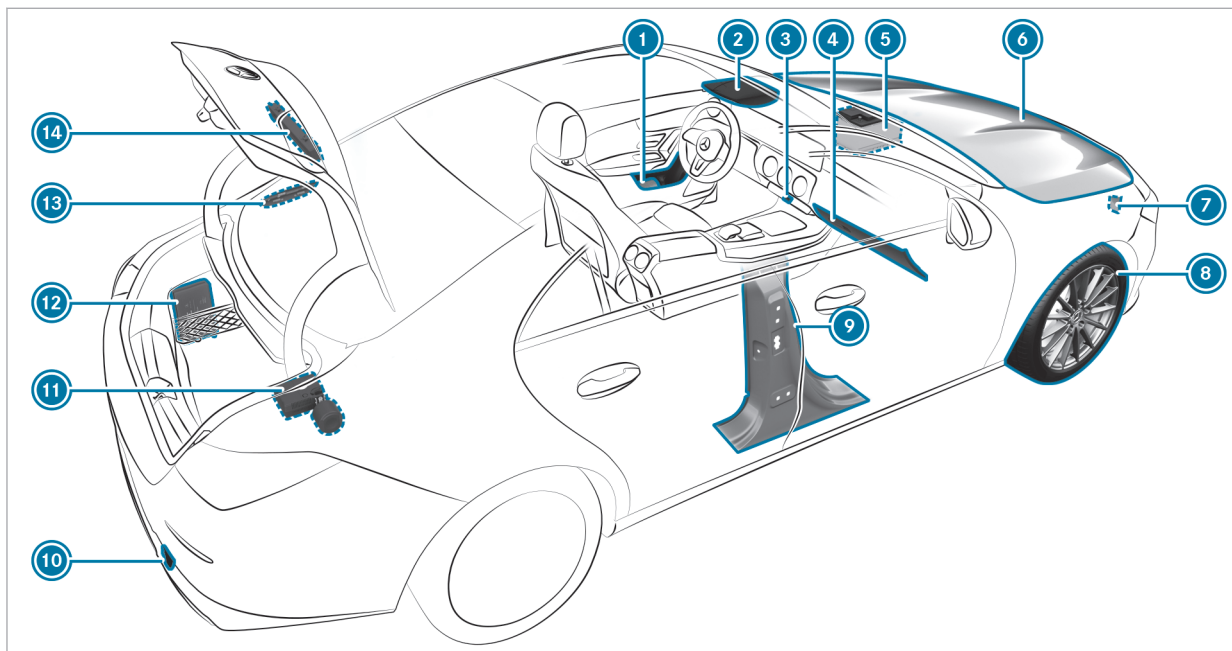

①	 Operates the memory function	→	111	⑪	 Child safety lock for the rear side windows	→	72
②	Adjusts the seats electrically	→	103	⑫	 Opens/closes the rear left side window	→	86
③	 Switches the seat heating on/off	→	106	⑬	 Opens/closes the left side window	→	86
④	 Mercedes-AMG vehicles only: switches seat ventilation on/off	→	107	⑭	Adjusts the head restraints	→	104
⑤	  Locks/unlocks the vehicle	→	78	⑮	Adjusts the seat backrest inclination	→	100
⑥	Opens the door	→	78	⑯	Adjusts the seat height	→	100
⑦	 Opens/closes the trunk lid	→	82	⑰	Adjusts the seat cushion inclination	→	100
⑧	 Operates the outside mirrors	→	134	⑱	Adjusts the seat fore-and-aft position	→	100
⑨	 Opens/closes the right side window	→	86	⑲	Adjusts the seat cushion length	→	100
⑩	 Opens/closes the rear right side window	→	86				



1	Safety vests	→	299
2	 me button	→	264
	 SOS button	→	264
3	 Hazard warning light system	→	127
4	Stowage compartment for customer literature		
5	Starting assistance	→	311
6	Checking and refilling operating fluids	→	356
7	Tow-starting or towing	→	314
8	Flat tire	→	301
9	B-pillar with:		

	QR code for accessing the rescue card	→	34
10	Tow-starting or towing	→	314
11	TIREFIT kit	→	303
12	First-aid kit (soft sided)	→	301
13	Fuel filler flap with:		
	information label on fuel type	→	161
	Information label on tire pressure	→	324
	QR code for accessing the rescue card	→	34
14	Warning triangle	→	300

Calling up the Digital Operator's Manual

Multimedia system:

→  » Info » Operator's Manual
 » Open Digital Operator's Manual

The Digital Operator's Manual describes the functions and operation of the vehicle and the multimedia system.

▶ Select one of the following menu items in the Digital Operator's Manual:

- **Quick start:** find the first steps towards adjusting your seat (driver's side).
- **Tips:** find information that prepares you for certain everyday situations with your vehicle.
- **Animations:** watch animations of the vehicle functions.
- **Messages:** receive additional information about the messages on the driver display.
- **Language:** select the language for the Digital Operator's Manual.

You can search for keywords using the search field **Search** in order to find quick answers to questions regarding operation of the vehicle.

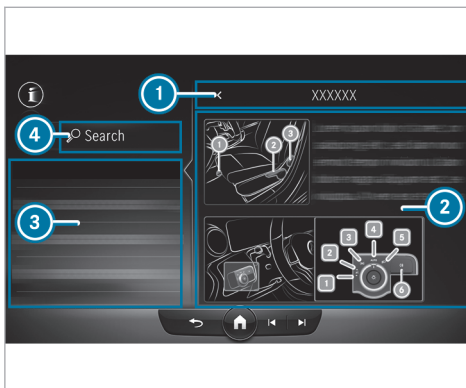

- 1 Back
- 2 Contents section
- 3 Menu
- 4 Search

Some sections in the Digital Operator's Manual, such as warning notes, can be expanded and collapsed.

Additional options for calling up the Digital Operator's Manual:

Driver display: call up brief information regarding display messages on the driver display. Pressing  will show brief information on the central display.

MBUX Voice Assistant: call-up via the voice control system

Global search: call up search results for contents of the Digital Operator's Manual in the home screen

 For safety reasons, the Digital Operator's Manual is deactivated while driving.

Protection of the environment

 **ENVIRONMENTAL NOTE** Environmental damage due to operating conditions and personal driving style

The pollutant emission of the vehicle is directly related to the way you operate the vehicle.

Operate your vehicle in an environmentally responsible manner to help protect the environment. Please observe the following recommendations on operating conditions and personal driving style.

Operating conditions:

- ▶ Make sure that the tire pressure is correct.
- ▶ Do not carry any unnecessary weight (e.g. roof luggage racks once you no longer need them).
- ▶ Adhere to the service intervals. A regularly serviced vehicle will contribute to environmental protection.

- ▶ Always have maintenance work carried out at a qualified specialist workshop.

Personal driving style:

- ▶ Do not depress the accelerator pedal when starting the engine.
- ▶ Do not warm up the vehicle while stationary.
- ▶ Drive carefully and maintain a suitable distance from the vehicle in front.
- ▶ Avoid frequent, sudden acceleration and braking.
- ▶ Change gear in good time and use each gear only up to $\frac{2}{3}$ of its maximum engine speed.
- ▶ Switch off the vehicle in stationary traffic, e.g. by using the ECO start/stop function.
- ▶ Drive in a fuel-efficient manner. Observe the ECO display for an economical driving style.

Environmental issues and recommendations:

It is recommended that you re-use or recycle materials instead of just disposing of them.

The relevant environmental guidelines and regulations serve to protect the environment and must be strictly observed.

Mercedes-Benz GenuineParts

 **ENVIRONMENTAL NOTE** Environmental damage due to not using recycled reconditioned components

Mercedes-Benz AG offers recycled reconditioned components and parts with the same quality as new parts. The same entitlement from the Limited Warranty is valid as for new parts.

- ▶ Use recycled reconditioned components and parts from Mercedes-Benz AG.

! **NOTE** Impairment of the operating efficiency of the restraint systems from installing accessory parts or from repairs or welding

Air bags and Emergency Tensioning Devices, as well as control units and sensors for the restraint systems, may be installed in the following areas of your vehicle:

- doors
- door pillars
- sill
- seats
- cockpit
- instrument display
- center console
- lateral roof frame

- ▶ Do not install accessory parts such as audio systems in these areas.
- ▶ Do not carry out repairs or welding.

▶ Have accessories retrofitted at a qualified specialist workshop.

You could jeopardize the operating safety of your vehicle if you use parts, tires and wheels, as well as accessories relevant to safety that have not been approved by Mercedes-Benz. Safety-critical systems (e.g. the brake system) may malfunction. Use only Mercedes-Benz GenuineParts or parts of equal quality. Use only tires, wheels and accessory parts that have been specifically approved for your vehicle model.

Mercedes-Benz GenuineParts are subject to strict quality inspections. Each part has been specially developed, manufactured or selected for Mercedes-Benz vehicles and adapted to them. Therefore, only Mercedes-Benz GenuineParts should be used.

More than 300,000 different Mercedes-Benz GenuineParts are available for Mercedes-Benz models.

All Mercedes-Benz Service Centers maintain a supply of Mercedes-Benz GenuineParts for necessary service and repair work. In addition, strategi-

cally located parts delivery centers ensure quick and reliable parts service.

Always specify the vehicle identification number (VIN) (→ page 354) when ordering Mercedes-Benz GenuineParts.

Operator's Manual

This Operator's Manual and the Digital Operator's Manual in the vehicle describe the following models and the standard and special equipment for your vehicle:

- The models and the standard and special equipment available at the time of this Operator's Manual going to press.
- The models and the standard and special equipment available only in certain countries.
- The models and the standard and special equipment that will become available only at a later date.

Please note that your vehicle may not be equipped with all features described. This also applies to systems relevant to safety. The equipment on

your vehicle may therefore differ from that in the descriptions and illustrations.

The original purchase agreement for your vehicle includes a list of the equipment in your vehicle at the time of delivery.

Should you have any questions concerning equipment and operation, please consult an authorized Mercedes-Benz Center.

i Please bear in mind that all the speed figures stated in this Operator's Manual are approximate and are subject to a certain tolerance.

The Operator's Manual, Supplement, further supplementary documents and Maintenance Booklet (USA only) are important documents and should be kept in the vehicle.

Touch-sensitive controls

In addition to conventional switches and buttons, your vehicle is equipped with touch-sensitive controls.

These are located in the following areas of your vehicle:

- Roof and door control panel
- Climate control
- Steering wheel
- MBUX multimedia system

The controls have touch-sensitive user interface surfaces. You can control these surfaces by pressing or swiping to adjust settings or to trigger functions, for example.

The touch-sensitive interface on the touchscreen also provides haptic feedback in the form of pulses, vibrations or changes in the surface structure, for example.

You will receive haptic feedback in the following situations, for example:

- When pressing a button on the user interface
- When scrolling in a list or table
- When you reach a new area on the user interface, e.g. a pop-up window

When using touch-sensitive user interfaces, note the following points to avoid problems:

- Do not affix stickers or similar objects to the surfaces.
- Do not attach smartphone holders or other mountings to the surface of the central display.
- Keep the surfaces protected from moisture and wet conditions.
- Keep the surfaces free of dust and dirt (→ page 296).

Some touch-sensitive controls have both a symbol and integrated indicator lamps. Be sure to press on the symbol of the control element when using it.

Mercedes me App

Notes about the on-demand feature

You can also activate various functions (on-demand feature) subsequently via Mercedes me after purchasing your vehicle.

Information is available at any authorized Mercedes-Benz Center.

Activating on-demand feature using Mercedes me

Requirements

- The vehicle has a wireless connection.
- The vehicle is linked to the Mercedes me user account.

Ordering and activating on-demand feature

- ▶ Add the desired on-demand feature for the vehicle to the shopping basket in the Mercedes me Store.
- ▶ Complete the order.
The on-demand feature is activated when operating the vehicle.

Speeding up activation

- ▶ Switch the vehicle off and lock it.

- ▶ Unlock the vehicle after about two minutes and switch on the vehicle.
The on-demand feature has been activated.
For some features, a notification also appears in the vehicle's multimedia system.

If the activation was not successful, repeat the process.

Service and vehicle operation

Vehicle operation outside the USA or Canada

When you are abroad with your vehicle, observe the following points:

- service points or replacement parts may not be available immediately.
- unleaded fuel may not be available for vehicles with a catalytic converter. Leaded fuel may cause damage to the catalytic converter.
- the fuel may have an extremely low octane number. Unsuitable fuel can cause engine damage.

Some Mercedes-Benz models are available in Europe through our European Delivery Program.

For more information, please consult a Mercedes-Benz service outlet, or write to one of the following addresses:

in the USA:

Mercedes-Benz USA, LLC
One Mercedes-Benz Drive
Sandy Springs, GA 30328

in Canada:

Mercedes-Benz Canada, Inc.
2680 Matheson Blvd E, Suite 500
Mississauga, ON L4W 0A5

Maintenance

USA only:

Your customer advisor confirms the service in the service report.

Roadside Assistance

The Mercedes-Benz Roadside Assistance Program offers technical help in the case of a breakdown. Your calls to the toll-free Roadside Assistance

Hotline are answered by our agents 24 hours a day, 365 days a year.

1-800-FOR-MERCEdes (1-800-367-6372) (USA)

1-800-387-0100 (Canada)

USA only: You can find further information in the Mercedes-Benz Roadside Assistance Program brochure.

Canada only: You can find further information in the "Roadside Assistance" section in the Warranty Information Guide. Please refer to Mercedes-Benz Canada's website:

<https://www.mercedes-benz.ca/en/owners/manuals> (English)

<https://www.mercedes-benz.ca/fr/owners/manuals> (French)

Change of address or change of ownership

In the event of a change of address, please send us the "Notification of address change" in the Service and Guarantee booklet or simply call the Mercedes-Benz Customer Assistance Center (USA) on the hotline number 1-800-FOR-MERCEdes (1-800-367-6372) or Customer Service (Canada) on 1-800-387-0100. We can then reach you in a timely fashion, if necessary.

If you sell your Mercedes, please leave all literature in the vehicle so that it is available to the next owner. If you have purchased a used vehicle, please send us the "Notice of Purchase of Used Car" in the Service and Guarantee booklet or simply call the Mercedes-Benz Customer Assistance Center (USA) at the hotline number 1-800-FOR-MERCEdes (1-800-367-6372) or Customer Service (Canada) at 1-800-387-0100.

Possible danger due to substances hazardous to health

In compliance with Proposition 65 ("Prop65"), the following detachable label has been added to each vehicle sold in California:



WARNING



Operating, servicing and maintaining a passenger vehicle, pickup truck, van or off-road motor vehicle can expose you to chemicals including engine exhaust, carbon monoxide, phthalates, and lead, which are known to the State of California to cause cancer and birth defects or other reproductive harm. To minimize exposure, avoid breathing exhaust, do not idle the engine except as necessary, service your vehicle in a well-ventilated area and wear gloves or wash your hands frequently when servicing your vehicle. For more information go to www.P65Warnings.ca.gov/passenger-vehicle

A 000 817 82 02

Operating safety



WARNING Risk of accident due to malfunctions or system failures

If you do not have the prescribed service/maintenance work or any required repairs carried out, this could result in malfunctions or system failures.

- ▶ Always have the prescribed service and maintenance work or any required repairs carried out in a qualified specialist workshop.

⚠ WARNING Risk of accident or injury due to incorrect modifications on electronic component parts

Modification of electronic components, their software or wiring could impair their function and/or the function of other networked component parts or safety-relevant systems.

This can endanger the operating safety of the vehicle.

- ▶ Never tamper with the wiring and electronic component parts or their software.
- ▶ You should have all work on electrical and electronic components carried out at a qualified specialist workshop.

Observe the "On-board electronics" section in "Technical data".

⚠ WARNING Risk of fire caused by flammable material on hot exhaust system components

Flammable material such as leaves, grass or twigs may ignite if they come into contact with hot parts of the exhaust system.

- ▶ When driving on an unpaved road or off-road, check the vehicle underside regularly.
- ▶ In particular, remove trapped plant parts or other flammable material.
- ▶ If there is damage, consult a qualified specialist workshop immediately.

! NOTE Damage to the vehicle due to driving too fast and due to impacts to the vehicle underbody or suspension components

In the following situations, in particular, there is a risk of damage to the vehicle:

- The vehicle becomes grounded, e.g. on a high curb or an unpaved road
- The vehicle is driven too fast over an obstacle, e.g. a curb, speed bump or pothole
- A heavy object strikes the underbody or suspension components

In situations such as these, damage to the body, underbody, suspension components, wheels or tires may not be visible. Components damaged in this way can unexpectedly fail or, in the case of an accident, may no longer absorb the resulting force as intended.

If the underbody paneling is damaged, flammable materials such as leaves, grass or twigs can collect between the underbody and the

underbody paneling. These materials may ignite if they come into contact with hot parts of the exhaust system.

- ▶ Have the vehicle checked and repaired immediately at a qualified specialist workshop.

or

- ▶ If driving safety is impaired while continuing your journey, pull over and stop the vehicle immediately, while paying attention to road and traffic conditions, and contact a qualified specialist workshop.

Vehicles with a 48 V on-board electrical system

⚠ DANGER Risk of fatal injury by touching damaged high-voltage components

Vehicles with a 48 V on-board electrical system contain individual high-voltage components. These high-voltage components are under high voltage.

If you modify component parts of these high-voltage components or touch damaged component parts, you may be electrocuted.

High voltage components may be damaged in an accident, although the damage may not be visible.

- ▶ Never perform modifications to component parts of high-voltage components.
- ▶ Never touch damaged component parts of high-voltage components.
- ▶ Never touch component parts of high-voltage components after an accident.

Vehicles with a 48 V on-board electrical system contain high voltage components. These components are marked with a high-voltage label:

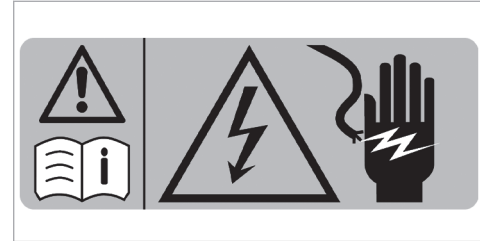

Example

All work on high voltage components must be carried out at a qualified specialist workshop.

Installing the license plate on the front license plate bracket

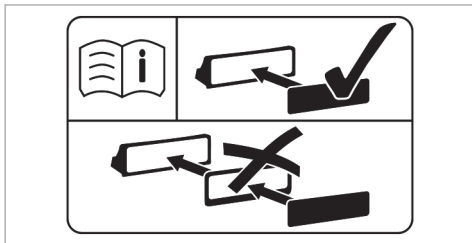

The information label can be found on the license plate bracket, either embossed or in sticker form.

! **NOTE** Malfunctions and system failures due to incorrect mounting of the license plate on the front license plate holder

If the license plate is incorrectly mounted on the front license plate holder, sensors, cameras or driving and safety systems may malfunction or fail.

Observe the following points when mounting the license plate on the front license plate holder:

- ▶ Mount the license plate directly on the license plate holder without advertising media or other holders.
- ▶ Mount the license plate so that it does not protrude above or to the side of the license plate adapter.

Country-specific information for regulatory radio components

Information regarding modifications to radio components

Modifications to radio components may invalidate the general operating permit for the radio component in question. The radio component manufacturer shall accept no responsibility for such modifications.

Information regarding crossing national borders

You must observe the radio regulatory provisions for the country in which you are currently driving when operating the vehicle.



USA: "Radio based devices of this vehicle comply with Part 15 of the FCC Rules. Operation is subject to the following two conditions: 1) These devices may not cause harmful interference, and 2) These devices must accept any interference received, including interference that may cause undesired operation. Changes or modifications not expressly approved by the party responsible for compliance could void the user's authority to operate the equipment."

Canada: "This vehicle contains licence-exempt transmitter(s)/receiver(s) that comply with Innovation, Science and Economic Development Canada's licence-exempt RSS(s). Operation is subject to the following two conditions: (1) These devices may not cause interference. (2) These devices must accept any interference, including interfer-

ence that may cause undesired operation of the devices." "Les émetteurs/récepteurs dans cette véhicule sont conforme aux CNR d'Innovation, Sciences et Développement économique Canada applicables aux appareils radio exempts de licence. L'exploitation est autorisée aux deux conditions suivantes : 1) Ces appareils ne doivent pas produire de brouillage; 2) Ces appareils doivent accepter tout brouillage radioélectrique subi, même si le brouillage est susceptible d'en compromettre le fonctionnement."

Diagnosics connection

The diagnostics connection is a technical interface in the vehicle. It is used, for example, in the context of repair and maintenance work or for reading out vehicle data in a specialist workshop. Diagnostic devices should therefore only be connected in a qualified specialist workshop.

⚠ WARNING Risk of accident due to connecting devices to the diagnostics connection

If you connect devices to the diagnostics connection of the vehicle, the function of vehicle systems and operating safety may be impaired.

- ▶ For safety reasons, we recommend that you use and connect only products approved by an authorized Mercedes-Benz Service Center.

⚠ WARNING Risk of accident due to objects in the driver's footwell

Objects in the driver's footwell may impede pedal travel or block a depressed pedal.

This will jeopardize the operating- and road safety of the vehicle.

- ▶ Stow all objects in the vehicle securely so that they cannot get into the driver's footwell.

- ▶ Make sure that there is always sufficient clearance for the pedals.
- ▶ Always install the floor mats securely and as prescribed.
- ▶ Do not use loose floor mats and do not place floor mats on top of one another.

! NOTE Battery discharging from using devices connected to the diagnostics connection

Using devices at the diagnostics connection drains the battery.

- ▶ Check the charge level of the battery.
- ▶ If the charge level is low, charge the battery, e.g. by driving a considerable distance.

Please also observe the notes on the 12 V battery and on short-distance trips in the chapter "Driving and Parking" (→ page 145).

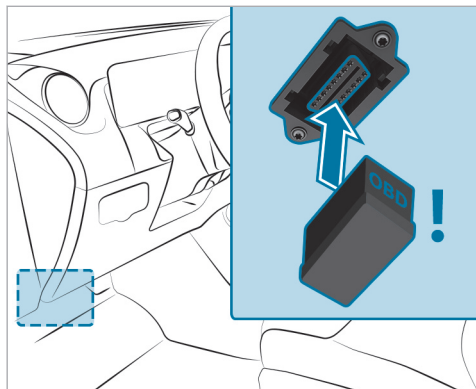

Connecting and using another device with the diagnostics connection can have the following effects:

- Malfunctions in the vehicle system
- Permanent damage to vehicle components

Please refer to the warranty terms and conditions for this matter.

Moreover, connecting equipment to the diagnostics connection can lead to emissions monitoring information being reset, for example. This may lead to the vehicle failing to meet the requirements of the next emissions inspection during the main inspection.

Qualified specialist workshop

A Mercedes-Benz service center is a qualified specialist workshop. It has the necessary special skills, tools and qualifications to correctly carry out the work required on your vehicle. This particularly applies to safety-critical work.

Always have the following work on your vehicle carried out by a Mercedes-Benz service center:

- Safety-critical work
- Service and maintenance work
- Repair work
- Modifications as well as installations and conversions
- Work on electronic components

- **Vehicles with 48 V on-board electrical system:** work on the high-voltage components of the 48 V on-board electrical system

Mercedes-Benz recommends a Mercedes-Benz service center.

Correct use of the vehicle

If you remove any warning stickers, you or others could fail to recognize certain dangers. Leave warning stickers in position.

Observe the following information in particular when driving your vehicle:

- the safety notes in this Operator's Manual, vehicle-specific supplements and further supplementary documents
- technical data for the vehicle
- traffic laws and regulations of the country you are currently driving in
- laws pertaining to motor vehicles and safety standards of the country you are currently driving in

- radio regulatory requirements of the country you are currently driving in

Notes for persons with electronic medical aids

Despite meticulous development of their vehicle systems, Mercedes-Benz AG cannot completely rule out the interaction of vehicle systems with electronic medical aids, such as cardiac pacemakers.

In addition, there are components installed in the vehicle that can generate magnetic fields on a par with permanent magnets, regardless of the operating status of the vehicle. These fields may occur in the area around the multimedia system and sound system, for example, or in the area around the seats, depending on the respective vehicle equipment.

In some cases, this could result in the following, depending on the aids used:

- Medical aids malfunctioning
- Adverse health effects

Observe the notes and warnings of the manufacturer of the medical aids; if in doubt, contact the device manufacturer and/or your doctor. If there is continuing uncertainty concerning the possibility of medical aids malfunctioning,

Mercedes-Benz AG recommends using fewer electrical vehicle systems and/or maintaining a distance from the components.

Always have repairs and maintenance work in the area of the following components carried out at a qualified specialist workshop:

- vehicle components carrying live voltage
- transmission antenna
- multimedia system and sound system

If you have any queries or suggestions, consult a qualified specialist workshop.

Problems with your vehicle

If you should experience any problem with your vehicle, particularly one that you believe may affect its safe operation, we urge you to contact a Mercedes-Benz Service Center immediately to

have the problem diagnosed and rectified. If the problem is not resolved to your satisfaction there, please contact a Mercedes-Benz Service Center again or write to one of the following addresses.

In the USA:

Mercedes-Benz USA, LLC
Customer Assistance Center
One Mercedes-Benz Drive
Sandy Springs, GA 30328

In Canada:

Mercedes-Benz Canada, Inc.
Customer Assistance Center
2680 Matheson Blvd E, Suite 500
Mississauga, ON L4W 0A5

Reporting safety defects

USA only:

The following text is published as required of manufacturers under Title 49, Code of U.S. Federal Regulations, Part 575 pursuant to the "National Traffic and Motor Vehicle Safety Act of 1966".

If you believe that your vehicle has a defect which could cause a crash or could cause injury or death, you should immediately inform the National Highway Traffic Safety Administration (NHTSA) in addition to notifying Mercedes-Benz USA, LLC.

If NHTSA receives similar complaints, it may open an investigation, and if it finds that a safety defect exists in a group of vehicles, it may order a recall and remedy campaign. However, NHTSA cannot become involved in individual problems between you, your dealer, or Mercedes-Benz USA, LLC.

To contact NHTSA, you may call the Vehicle Safety Hotline toll-free at 1-888-327-4236 (TTY: 1-800-424-9153) ; go to <https://www.safercar.gov>; or write to: Administrator, NHTSA, 400 Seventh Street, SW., Washington, DC 20590, USA.

You can also obtain other information about motor vehicle safety from <https://www.safercar.gov>.

Canada only:

The following text is published as required of manufacturers under subsection 18.4 (4) of the Motor Vehicle Safety Regulations.

If you believe that your vehicle has a defect which could cause a crash or could cause injury or death, you should immediately inform Transport Canada in addition to notifying Mercedes-Benz Canada Inc.

If Transport Canada received similar complaints, it may open an investigation, and if it finds that a safety defect exists in a group of vehicles, it may order a recall and remedy campaign. However, Transport Canada cannot become involved in individual problems between you, your dealer, or Mercedes-Benz Canada Inc.

To contact Transport Canada, you may call the Defect Investigations and Recalls Division toll-free in Canada at 1-800-333-0510 or 819-994-3328 in the Gatineau-Ottawa area or internationally; may also go to the following websites for more information:

- English: <https://www.tc.gc.ca/recalls>
- French: <https://www.tc.gc.ca/rappels>

Limited Warranty

! **NOTE** Damage to the vehicle arising from violation of these operating instructions.

Damage to the vehicle can arise from violation of these operating instructions.

This damage is not covered either by the Mercedes-Benz implied warranty or by the New- or Used-Vehicle Warranty.

► Follow the instructions in these operating instructions on proper operation of your vehicle as well as on possible vehicle damage.

QR code for rescue card

QR codes are attached to the inside of the fuel filler flap and on the opposite side on the B-pillar. In the event of an accident, rescue services can use the QR code to quickly find the appropriate rescue card for your vehicle. The current rescue card contains the most important information about your vehicle (e.g. the routing of the electric lines) in compact form.

You can find further information at: <https://rk.mb-qr.com/de/>

Data storage

Data processing in the vehicle

Electronic control units

There are electronic control units installed in your vehicle. Control units process data that they e.g. receive from vehicle sensors, generate themselves or exchange among themselves. Some control units are required for the safe operation of your vehicle. For example, some assist you when you are driving, such as driver assistance systems, while others enable convenience or infotainment functions.

The following provides you with general information regarding data processing in the vehicle. Additional information on what specific data is collected, stored and transmitted to third parties for what purpose in your vehicle can be found in the notes on the functional features in question in the respective operating instructions. These are

also available online and, depending on the equipment, digitally in the vehicle.

Personal data

Each vehicle is marked with a unique vehicle identification number. Depending on the country, this vehicle identification number can be used by, for example, government authorities to determine the identity of the owner. There are other possibilities for using data collected from the vehicle to identify the owner or driver, such as the license plate number.

The data generated or processed by control units may therefore be personal or, in certain circumstances, become personal. Depending on which vehicle data are available, it may be possible to make inferences about, for example, your driving behavior, your location, your route or your use patterns.

Legal requirements for the disclosure of data

If legal regulations exist, manufacturers are generally obligated to release data stored by the manufacturer to the necessary extent in individual cases at the request of state authorities. This may

be the case during the investigation of a criminal offense, for example.

Within the framework of applicable law, state authorities are also authorized to take data readouts from vehicles themselves in specific cases. In the event of an accident, for example, information readouts can be taken from the air bag control unit to help to establish what happened.

Operating data in the vehicle

Control units process data to operate the vehicle.

This includes the following data, for example:

- Vehicle status information such as speed, longitudinal acceleration, lateral acceleration, number of wheel revolutions or the fastened seat belts indicator
- Ambient conditions, such as temperature, rain sensor or distance sensor

As a rule, this data is volatile, is not stored beyond the operating time and is processed only in the vehicle itself. Control units (e.g. the vehicle key) often contain data memories. These are used to temporarily or permanently document information about the vehicle's operating state, component

stress, maintenance requirements or technical events and malfunctions.

Depending on the technical equipment, the following data will be stored:

- Operating status of system components (e.g. fill levels, tire pressure, battery status)
- Malfunctions or faults in important system components (e.g. lights, brakes)
- System reactions in special driving situations (e.g. air bag deployment, the intervention of stability control systems)
- Information on events leading to vehicle damage

In special cases, it may be necessary to store data that would otherwise only be volatile. This may be the case if the vehicle has detected a malfunction, for example.

If you use services such as repair services or maintenance work, stored operational data readouts can be taken and used together with the vehicle identification number, where necessary. Readouts can be taken by service network employees such as workshops and manufactur-

ers, or third parties, such as breakdown services. The same is true in the case of warranty claims and quality assurance measures.

The readout will usually be taken via the diagnostics connection in the vehicle, which is required by law. The operating data readout documents technical conditions of the vehicle or individual components and helps to diagnose malfunctions, meet warranty obligations and improve quality. This data, particularly information on component stress, technical events, operating errors and other malfunctions, will be transmitted to the manufacturer for this purpose together with the vehicle identification number if necessary. In addition, the manufacturer is subject to product liability. For this reason, the manufacturer also uses operational data from the vehicle for e.g. recalls. This data can also be used to check customer claims for warranty and guarantee.

Fault memories in the vehicle can be reset by a service outlet or at your request as part of repair or maintenance work.

Comfort and infotainment functions

You can save comfort settings and individualization in the vehicle and change or reset them at any time.

Depending on the vehicle equipment, this includes the following settings, for example:

- Seat positions and steering wheel positions
- Suspension tuning and climate control settings
- Custom settings (e.g. interior lighting)

You can incorporate data into the vehicle's infotainment functions yourself as part of the selected equipment.

Depending on the vehicle equipment, this includes the following data, for example:

- Multimedia data (e.g. music, films or photos for playback in an integrated multimedia system)
- Address book data for use in conjunction with an integrated hands-free system or an integrated navigation system

- Navigation destinations that have been entered
- Data about the use of internet services

This data for comfort and infotainment functions can be saved locally in the vehicle or stored on a device that you have connected to the vehicle (e.g. smartphone, USB flash drive or MP3 player). If you have entered data yourself, you can delete it at any time.

The transfer of this data out of the vehicle will take place exclusively at your request. This applies in particular when you are using online services according to the settings you have selected.

Smartphone integration (e.g. Android Auto or Apple CarPlay®)

If your vehicle is equipped appropriately, you can connect your smartphone or another mobile device to the vehicle. You will then be able to control them using the controls integrated in the vehicle. The smartphone's picture and sound can be output via the multimedia system. Specific items of information will also be transferred to your smartphone. Depending on the type of integra-

tion, this may include position data, day/night mode and other general vehicle statuses. Please refer to the vehicle Operator's Manual / infotainment system operating instructions for further information.

This integration allows the use of selected smartphone apps (e.g. navigation apps, music player apps). There will be no further interaction between your smartphone and the vehicle; in particular, vehicle data will not be directly accessible. The type of additional data processing is determined by the provider of the app being used. Whether you can configure settings for it and, if so, which ones, depend on the app and your smartphone's operating system.

Online services

Wireless network connection

If your vehicle has a wireless network connection, it enables data to be exchanged between your vehicle and additional systems. The wireless network connection is made possible by the vehicle's own transmitter and receiver or by a mobile end device that you have brought into the vehicle, for

example, a smartphone. Online functions can be used via the wireless network connection. This includes online services and applications/apps provided to you by the manufacturer or by other providers.

Manufacturer's services

Regarding the manufacturer's online services, the individual functions are described by the manufacturer in a suitable place, for example, in the Operator's Manual or on the manufacturer's website, where the relevant data protection information is also given. Personal data may be used for the provision of online services. Data is exchanged via a secure connection, such as the manufacturer's designated IT systems. Any personal data which is collected, processed and used, other than for the provision of services, is done so exclusively on the basis of legal permission. This is the case, for example, for a legally prescribed emergency call system, a contractual agreement or when consent has been given.

You can have services and functions, some of which are subject to a fee, activated or deactivated. This excludes legally prescribed functions and services, such as an emergency call system.

Third-party services

If you use online services from other providers (third parties), these services are the responsibility of the provider in question and subject to that provider's data protection conditions and terms of use. As a general rule, the manufacturer has no influence on the content exchanged.

For this reason, when services are provided by third parties, please ask the service provider in question for information about the type, extent and purpose of the collection and use of personal data.

Data protection rights

Depending on your country or the equipment and range of functions of your vehicle as well as the services you use and the services on offer, you are entitled to different data protection rights. Further information on data protection and your data protection rights can either be found on the manufacturer's website or you will receive this information as part of the various services and service offers. There you will also find the contact

information for the manufacturer and its data protection officers.

At a workshop, for example, with the support of a specialist and possibly for a fee, you can have data read out which is stored only locally in the vehicle.

MBUX multimedia system/Mercedes me connect

If the vehicle is equipped with the MBUX multimedia system or Mercedes me connect, additional data about the vehicle's operation, the use of the vehicle in certain situations, and the location of the vehicle may be compiled by the MBUX multimedia system or Mercedes me connect.

For additional information, please refer to the "MBUX multimedia system" section and/or the Mercedes me connect Terms and Conditions.

Event data recorder

USA only:

This vehicle is equipped with an event data recorder (EDR). The main purpose of an EDR is to

record, in certain crash or near crash-like situations, such as an air bag deployment or hitting a road obstacle, data that will assist in understanding how a vehicle's systems performed. The EDR is designed to record data related to vehicle dynamics and safety systems for a short period of time, typically 30 seconds or less.

The EDR in this vehicle is designed to record such data as:

- How various systems in your vehicle were operating;
- Whether or not the driver and passenger safety belts were buckled/fastened;
- How far (if at all) the driver was depressing the accelerator and/or brake pedal; and,
- How fast the vehicle was traveling.

These data can help provide a better understanding of the circumstances in which crashes and injuries occur. NOTE: EDR data are recorded by your vehicle only if a non-trivial crash situation occurs; no data are recorded by the EDR under normal driving conditions and no personal data (e.g., name, gender, age, and crash location) are

recorded. However, other parties, such as law enforcement could combine the EDR data with the type of personally identifying data routinely acquired during a crash investigation.

To read data recorded by an EDR, special equipment is required, and access to the vehicle or the EDR is needed. In addition to the vehicle manufacturer, other parties, such as law enforcement, that have the special equipment, can read the information if they have access to the vehicle or the EDR.

EDR data may be used in civil and criminal matters as a tool in accident reconstruction, accident claims, and vehicle safety. Since the Crash Data Retrieval CDR tool that is used to extract data from the EDR is commercially available, Mercedes-Benz USA, LLC („MBUSA“) expressly disclaims any and all liability arising from the extraction of this information by unauthorized Mercedes-Benz personnel.

MBUSA will not share EDR data with others without the consent of the vehicle owners or, if the vehicle is leased, without the consent of the lessee. Exceptions to this representation include responses to subpoenas by law enforcement; by

federal, state or local government; in connection with or arising out of litigation involving MBUSA or its subsidiaries and affiliates; or, as required by law.

Warning: The EDR is a component of the Restraint System Module. Tampering with, altering, modifying or removing the EDR component may result in a malfunction of the Restraint System Module and other systems.

State laws or regulations regarding EDRs that conflict with federal regulation are pre-empted. This means that in the event of such conflict, the federal regulation governs. As of Dec 2016, 17 states have enacted laws relating to EDRs.

Copyright

Free and open source software

Information on licenses for free and open-source software used in your vehicle can be found on the data carrier in your vehicle document wallet and with updates on the following website:

<https://www.mercedes-benz.com/opensource>

Registered trademarks

- Bluetooth® is a registered trademark of Bluetooth SIG, Inc.
- DTS™ is a registered trademark of DTS, Inc.
- Dolby® and MLP™ are registered trademarks of DOLBY Laboratories.
- ESP® and PRE-SAFE® are registered trademarks of Mercedes-Benz Group AG.
- HomeLink® is a registered trademark of Genex Corporation.
- iPod® and iTunes® are registered trademarks of Apple Inc.
- Burmester® is a registered trademark of Burmester Audiosysteme GmbH.
- Microsoft® and Windows Media® are registered trademarks of Microsoft Corporation.
- SiriusXM® is a registered trademark of Sirius XM Radio Inc.
- HD Radio™ is a registered trademark of iBiquity Digital Corporation.



40 General notes

- Gracernote[®] is a registered trademark of Gracernote, Inc.
- ZAGAT Survey[®] and related brands are registered trademarks of Zagat Survey, LLC.

Brief overview of the most important points

Basic information

In particular ensure the following conditions to enable the components of the restraint system to unfold their protective potential:

- Sit correctly (→ page 42).
- Fasten the seat belt correctly (→ page 43).
 - Function of the  seat belt warning lamp (→ page 45).
 - Function of the rear seat belt status display (→ page 45).
- The  restraint system warning lamp has gone out after the self-test (→ page 44).
- The PASSENGER AIR BAG indicator lamps display the correct status of the front passenger air bag (→ page 46).

For clear understanding

The chapter "Occupant safety" includes information on equipment, functions and behaviors that contribute directly to safety of vehicle occupants.

The information is structured as follows:

- **The most important information in brief:** in this chapter, you are provided with an overview of the relationship between the restraint system and the correct behavior of all vehicle occupants.
- **Specific information:** in further sections of the chapter "Occupant safety", you can find specific information on the equipment and functions of the restraint system.
- **Keyword directory:** you can also find certain subjects in this Operator's Manual using the keyword directory.

Information on the following subjects, among others, are not provided in the chapter "Occupant safety":

- Children in the vehicle (→ page 58)
- Driving and driving safety systems (→ page 172)
- Stowage areas (→ page 112)

Defining generic terms clearly

In this Operator's Manual, the following generic terms are used:

- **Occupant safety:** comprises the components and system functions which help to minimize, as much as possible, the stresses on and consequences for vehicle occupants during an accident.
- **Restraint system:** comprises those components which, along with the vehicle structure, help prevent vehicle occupants from potentially coming into contact with parts of the vehicle interior. The seat belts and air bags, for example, are components of the restraint system.
- **Child restraint system:** you can find all information on this subject in the chapter "Children in the vehicle" (→ page 58).

Be diligent

For the components of the restraint system to provide the intended level of protection, it is essential that your posture is correct and that the seat belt is correctly fastened.

Please bear in mind that carelessness regarding the seating position and putting on the seat belt may have serious consequences. Be diligent and make sure that all vehicle occupants are sitting correctly and have fastened their seat belts properly before starting every journey.

Information on the correct seat position

The seat position must be correct in order for the components of the restraint system to provide the intended level of protection.

The seat position influences both the protection provided by the seat belt and the additional protection provided by the air bag.

The correct seat position with an almost upright posture and a correctly fastened seat belt also reduce the risk posed by the air bag when it is deployed.

When choosing the seat, take note of the available space. When you are sitting with the right posture in a nearly upright position, your head should not touch the roof.

⚠ WARNING Risk of injury or death due to an incorrect seat position

If you deviate from the correct seat position, the air bag cannot provide its intended protective function.

Each vehicle occupant must make sure of the following.

- ▶ Put the seat in the correct position.
- ▶ Fasten seat belts correctly. Pregnant women must take particular care to ensure that the lap belt never lies across the abdomen.
- ▶ Observe the following information.

In order for the restraint system to provide the intended level of protection, observe the following information:

- Before starting your journey, adjust your seat correctly (→ page 97).

When doing so, make sure you are able to fasten your seat belt correctly. The shoulder belt strap must be routed forward from the seat belt outlet over the center of your shoulder.

- Keep your distance from the air bags, especially the front air bags. Set the driver's seat and front passenger seat as far back as possible while making sure the seat belt is fastened correctly.
- If persons are sitting on the rear seats, vehicle occupants should maintain a sufficient distance to the parts of the vehicle interior in front of them.
- Make sure there are no people, animals or objects between the vehicle occupants and an air bag.
- If you are the driver, observe the following information on the correct position of the driver's seat (→ page 97).
 - Hold the steering wheel only by the steering wheel rim. This allows the driver's air bag to fully deploy.
- Assume a nearly upright position, with your buttocks as far back as possible in the gap between the seat cushion and seat backrest. This ensures that your back lies as flat and firmly as possible against the seat backrest.

- While driving, do not lean forward and do not lean against the door or side window. You may otherwise be in the deployment area of the air bags.
- Sit with your feet resting on the floor, if possible. Your thighs are slightly supported by the seat cushion

Do not put your feet up on the cockpit, for example. Your feet may otherwise be in the deployment area of the air bag.

- Fasten the seat belt correctly.

Notes on wearing the seat belt correctly

Always fasten your seat belt correctly before starting a journey. A seat belt can provide the best level of protection only if it is worn correctly.

⚠ WARNING Risk of injury or death due to incorrectly fastened seat belt

If the seat belt is not worn correctly, it cannot perform its intended protective function.

In addition, an incorrectly fastened seat belt can also cause injuries, for example, in the event of an accident or when braking or changing direction suddenly.

- ▶ Always ensure that all vehicle occupants have their seat belts fastened correctly and are sitting properly.

⚠ WARNING Risk of injury or death when additional restraint systems are not used for persons with a smaller stature

Persons under 5 ft (1.50 m) tall cannot wear the seat belt correctly without a suitable additional restraint system.

- ▶ Always secure persons under 5 ft (1.50 m) tall in a suitable restraint system.

Each vehicle occupant must observe the following notes in particular:

- The seat belt must not be twisted:

- The shoulder belt strap must be routed forward from the seat belt outlet over the center of your shoulder.
- The shoulder belt strap should neither touch your neck nor be routed under your arm or behind your back.
- The lap belt must be routed as low down across the hips as possible.

In addition, push the lap belt down as far as possible across your hips and pull tight with the shoulder belt strap. Never route the lap belt across your abdomen.

Pregnant women must also take particular care with this.

- The shoulder belt strap and lap belt must fit snugly against the body after being tightened.
- Avoid wearing bulky clothing, e.g. a winter coat.
- Never route the seat belt across sharp, pointed, abrasive or fragile objects.
- Only one person should use each seat belt at any one time.

44 Occupant safety – Brief overview of the most important points

- Never secure objects with a seat belt if the seat belt is also being used by one of the vehicle's occupants.

Also ensure that no objects, e.g. a cushion, are ever placed between a person and the seat.

Fastening seat belts

If the seat belt is pulled quickly or sharply, the seat belt retractor locks. The seat belt strap cannot be pulled out any further.



- ▶ Always engage seat belt tongue ② of the seat belt into seat belt buckle ① of the corresponding seat.

! **NOTE** Deployment of components of the restraint system when the front passenger seat is unoccupied and a seat belt is buckled

When the front passenger seat is unoccupied and the seat belt tongue of the seat belt is engaged in the seat belt buckle, components of the restraint system may deploy unnecessarily on the front passenger side, e.g. the Emergency Tensioning Device.



▶ Only buckle the seat belts as intended.

i Observe the information on the special seat belt retractor of the seat belt (→ page 66).

Function of the restraint system warning lamp

When the vehicle is switched on, a self-test will be performed, during which the  restraint system warning lamp will light up. It will disappear no later than a few seconds after the vehicle is started. The components of the restraint system will then be functional.

A malfunction has occurred in the restraint system if:

- the  restraint system warning lamp does not light up or lights up continuously when the vehicle is switched on
- the  restraint system warning lamp lights up continuously or repeatedly during a journey

If components of the restraint system have been deployed, the  restraint system warning lamp will light up continuously.

⚠ WARNING Risk of injury due to malfunctions in the restraint system

Components in the restraint system may be activated unintentionally or not deploy as planned in an accident.

- ▶ Have the restraint system checked and repaired immediately at a qualified specialist workshop.

Mercedes-Benz recommends that you have the vehicle towed to a qualified specialist workshop.

Function of the seat belt warning lamp

The  seat belt warning lamp on the instrument display alerts you to the fact that the driver and/or front passenger are not wearing their seat belts.

The  seat belt warning lamp lights up for six seconds every time the vehicle is started.

All vehicle occupants must fasten their seat belts correctly (→ page 43).

In addition, a warning tone may sound.

When the driver's and front passenger doors are closed and the driver and front passenger have fastened their seat belts, the seat belt warning will go out.

In the following cases, the seat belt warning will light up during a journey if:

- The driver or front passenger has not fastened their seat belt and the following criteria apply:
 - The vehicle speed exceeds 5 mph (9 km/h) for more than 20 seconds.
 - The vehicle speed exceeds 15 mph (25 km/h) once.

- The driver or front passenger unfastens their seat belt while the vehicle is in motion.

Function of the rear seat belt status indicator

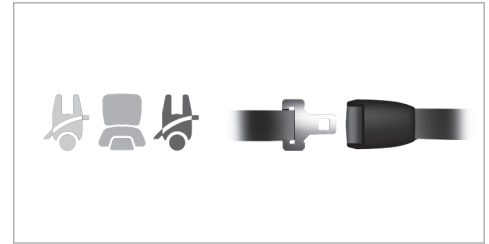

When the vehicle is switched on, the rear seat belt status indicator will inform you for a certain amount of time which rear seat belt is not fastened.

The status of the rear seat belt can be recognized by the color of the symbol on the driver display:

- Gray: the seat belt tongue of a rear seat belt is not engaged in the seat belt buckle of the corresponding seat.

- Green: the seat belt tongue of a rear seat belt is engaged in the seat belt buckle of the corresponding seat.

All vehicle occupants must always fasten their seat belts correctly before starting a journey.

- Red: a vehicle occupant in the rear passenger compartment has released the seat belt buckle using the release button and may not be properly secured.

If a vehicle occupant unfastens a seat belt in the rear passenger compartment, the rear seat belt status indicator will appear again.

In addition, a warning tone may sound.

Function of the PASSENGER AIR BAG indicator lamps (front passenger air bag)



The PASSENGER AIR BAG indicator lamps display the status of the front passenger air bag.

If the front passenger seat is occupied or a child restraint system is mounted on the front passenger seat, you must ensure, both before and during the journey, that the status of the front

passenger air bag is correct for the current situation.

⚠ WARNING Risk of potentially fatal injuries due to objects trapped under the front passenger seat

Objects trapped under the front passenger seat may interfere with the function of the automatic front passenger air bag shutoff or damage the system.

- ▶ Do not stow any objects under the front passenger seat.
- ▶ When the front passenger seat is occupied, ensure that no objects have become trapped beneath the front passenger seat.

Self-test: when the vehicle is switched on, both the PASSENGER AIR BAG ON and OFF indicator lamps will light up simultaneously for several seconds.

After the self-test, you can determine the status of the front passenger air bag as follows:

- **Front passenger air bag disabled:** PASSENGER AIR BAG OFF lights up continuously.

The front passenger air bag will not be deployed in the event of an accident. If PASSENGER AIR BAG OFF is lit, no one may use the front passenger seat.

If a rearward-facing child restraint system is installed on the front passenger seat, PASSENGER AIR BAG OFF must be lit continuously.

- **Front passenger air bag enabled:** PASSENGER AIR BAG ON lights up for up to 60 seconds or until both the PASSENGER AIR BAG ON and OFF indicator lamps go out.

The front passenger air bag may be deployed during an accident. If the front passenger air bag has this status, a rearward-facing child restraint system must not be installed on the front passenger seat.

- ① If you are driving with a child in the vehicle, observe the information in the chapter entitled "Children in the vehicle" (→ page 58)

⚠ WARNING Risk of injury or death due to a disabled front passenger airbag

The front passenger airbag is disabled when the PASSENGER AIR BAG OFF indicator lamp is lit.

A person in the front passenger seat could then, for example, come into contact with the vehicle interior, especially if the person is sitting too close to the cockpit.

If the front passenger seat is occupied, always ensure that:

- The classification of the person in the front passenger seat is correct and the front passenger airbag is enabled or disabled in accordance with the person in the front passenger seat.
- The front passenger seat has been moved as far back as possible.

- The person is seated correctly.
- ▶ Both before and during the journey, ensure that the status of the front passenger airbag is correct.

Malfunction on automatic front passenger air bag shutoff

The PASSENGER AIR BAG OFF indicator lamp and the  restraint system warning lamp light up simultaneously.

In this case, no one may use the front passenger seat and no child restraint system may be installed on the front passenger seat.

Have the automatic front passenger air bag shutoff checked and repaired immediately at a qualified specialist workshop.

Be sure to also observe the following further related topics:

- Child restraint system on the front passenger seat (→ page 62)

Disabling or enabling the front passenger air bag

The automatic front passenger air bag shutoff can disable or enable the front passenger air bag and front passenger knee bag according to the situation.

This happens automatically as a result of the classification of the person or child restraint system on the front passenger seat.

You cannot manually disable or enable the front passenger air bag.

Also observe the following information:

- For the status of the front passenger air bag, see "Function of the PASSENGER AIR BAG indicator lamps" (→ page 46)
- For information on using the automatic front passenger air bag shutoff, see "Information on the automatic front passenger air bag shutoff" (→ page 48)
- If you are driving with a child in the vehicle, observe the chapter "Children in the vehicle" (→ page 58)

Information on the child restraint system

When installing a child restraint system, observe the notes in "Children in the vehicle" (→ page 58).

Notes on the child restraint system on the front passenger seat

⚠ WARNING Risk of injury or fatal injuries if the front passenger air bag is enabled

If the front passenger air bag is enabled, a child on the front passenger seat may be struck by the front passenger air bag in the event of an accident.

▶ NEVER use a rearward-facing child restraint system on a seat with an ENABLED FRONT AIR BAG. This can result in the DEATH of or SERIOUS INJURY to the CHILD.

Also pay particular attention to the notes on rearward-facing or forward-facing child restraint systems on the front passenger seat (→ page 62).

Information on the automatic functions of the restraint system

Function of automatic front passenger air bag shutoff

A person on the front passenger seat must observe the following instructions:

- Sit correctly (→ page 42).
- Fasten seat belts correctly (→ page 43).

The automatic front passenger air bag shutoff can disable or enable the front passenger air bag and front passenger knee bag according to the situation.

Make sure you observe the following information:

- The status of the front passenger air bag; see "Function of the PASSENGER AIR BAG indicator lamps" (→ page 46).
- When installing a child restraint system on the front passenger seat, observe the vehicle-specific information (→ page 62).

Status of the front passenger air bag in relation to the stature of the person:

- **Front passenger air bag disabled:** PASSENGER AIR BAG OFF lights up continuously.
The front passenger air bag will not be deployed in the event of an accident. If PASSENGER AIR BAG OFF is lit, no one may use the front passenger seat.
- **Front passenger air bag enabled:** PASSENGER AIR BAG ON lights up for up to 60 seconds or until both the PASSENGER AIR BAG ON and OFF indicator lamps go out.

The front passenger air bag may be deployed during an accident. Observe the following information on the correct seat position (→ page 42).

Vehicles with rear seats: a person of smaller stature should use a rear seat.

System limits

The front passenger air bag may otherwise be disabled by mistake, e.g. in the following situation:

- The front passenger transfers their weight by supporting themselves on a vehicle armrest.
- The front passenger sits in such a way that their weight is raised from the seat surface.

! **NOTE** Deployment of components of the restraint system when the front passenger seat is unoccupied

In an accident, the components of the restraint system may deploy unnecessarily on the front passenger side if:

- There are heavy objects on the front passenger seat.
- The seat belt tongue is engaged in the seat belt buckle of the front passenger seat and the front passenger seat is unoccupied.

- ▶ Store objects in a suitable place.
- ▶ Only one person should use each seat belt at any one time.

Depending on the detected accident situation, the window air bag on the front passenger side may deploy. The air bag will be deployed regardless of whether the front passenger seat is occupied.

Function of PRE-SAFE® (anticipatory occupant protection)

PRE-SAFE® is able to detect certain critical driving situations and implement pre-emptive measures to protect the vehicle occupants.

PRE-SAFE® can implement the following measures independently of each other:

- tightening the seat belts on the driver's seat and front passenger seat.
- closing the side windows.
- **Vehicles with sliding sunroof:** closing the sliding sunroof.
- **Vehicles with memory function:** moving the front passenger seat to a more favorable seat position.
- **PRE-SAFE® Sound:** provided that the multimedia system is switched on, generating a brief

noise signal to stimulate the innate protective mechanism of a person's hearing.

! **NOTE** Damage caused by objects in the footwell or behind the seat

The automatic adjustment of the seat position may result in damage to the seat and/or the object.

▶ Stow objects in a suitable place.

Reverting the PRE-SAFE® system measures

If an accident did not occur, the pre-emptive measures that were taken will be reversed.

You will need to perform certain settings yourself.

- ▶ If the seat belt pre-tensioning is not reduced, move the seat backrest back slightly. The locking mechanism will release.

Seat belt adjustment function

Vehicles with PRE-SAFE®: after a front seat belt has been fastened, the automatic seat belt adjust-

ment may apply a certain tightening force by gently pulling taut from the shoulder. Do not hold onto the seat belt while it is adjusting.

You can activate and deactivate the seat belt adjustment function using the multimedia system.

Activating/deactivating seat belt adjustment via the multimedia system

Multimedia system:

➤  ➤ Settings ➤ Vehicle

➤ Occupant Protection

- ▶ Activate or deactivate **Belt adjustment**.

Overview of automatic measures after an accident

Depending on the type and severity of the accident, and depending on the vehicle's equipment, the following measures may be implemented, for example:

- automatic braking (post-collision brake)
- activating the hazard warning lights

- triggering an automatic emergency call (→ page 271)

- switching off the engine

To start the vehicle again, switch the vehicle off and back on (→ page 142). Depending on the type and severity of the accident, the vehicle may no longer start.

- shutting off the fuel supply
- unlocking the vehicle doors
- lowering the side windows
- displaying the emergency guide on the central display
- switching on the interior lighting

Function of the post-collision brake after an accident

Depending on the accident situation, the post-collision brake can minimise the severity of a further collision or even avoid it.

If an accident is detected, the post-collision brake can initiate automatic braking. When the vehicle

has come to a standstill, the electric parking brake is automatically applied.

The driver can cancel automatic braking by taking the following actions:

- Braking more strongly than automatic braking
- Fully depressing the accelerator pedal with force

Purpose and function of the restraint system

Overview of deployment situations (restraint system)

Make sure that the following prerequisites in particular have been met so that the components of the restraint system are able to provide the intended level of protection:

- Sit correctly (→ page 42).
- Fasten the seat belt correctly (→ page 43).
 - Function of the seat belt warning lamp (→ page 45).
 - Function of the rear seat belt status display (→ page 45).

- The restraint system warning lamp  is not lit up after the self-test (→ page 44).
- The PASSENGER AIR BAG indicator lamps display the correct status of the front passenger air bag (→ page 46).

Depending on the detected deployment situation, the components of the restraint system can be activated or deployed independently of each other:

- Emergency Tensioning Device: frontal impact, rear impact, side impact, rollover
- Driver's air bag, front passenger air bag: frontal impact
- Knee air bag: frontal impact
- Side impact air bag: side impact
- Window curtain air bag: side impact, rollover, frontal impact

The installation location of an air bag is identified by the AIRBAG symbol (→ page 57).

Observe the information on the function of the restraint system (→ page 51).

Information on how the restraint system works

The function of the restraint system depends on the severity of the impact detected and the apparent type of accident.

For more information about types of accidents, see "Overview of deployment situations" (→ page 51).

The activation thresholds for the components of the restraint system are determined based on the evaluation of the sensor values measured at various points in the vehicle. This process is pre-emptive in nature. The triggering of the components of the restraint system must take place in good time at the start of the impact.

Factors that can be seen and measured only after a collision has occurred do not play a decisive role in the deployment of an air bag, nor do they provide an indication of air bag deployment.

The vehicle may be deformed significantly without an air bag being deployed. This is the case if only parts that are relatively easily deformed are affected and the rate of vehicle deceleration is not high. Conversely, an air bag may be deployed even though the vehicle suffers only minor defor-

mation. If very rigid vehicle parts, such as longitudinal members, are hit, the vehicle deceleration may be high enough for this to happen.

Depending on the apparent type of accident and the detected deployment situation, Emergency Tensioning Devices and/or air bags supplement the protection offered by a correctly worn seat belt.

When enabled, an air bag can provide additional protection for the respective vehicle occupant.

Potential protection provided by each air bag:

- Knee air bag: thighs, knees and lower legs
- Driver's air bag, front passenger air bag: head and ribcage
- Window air bag: head
- Side air bag: ribcage and pelvis

NOTE Mercedes-AMG vehicles

▶ Observe the notes in the Supplement. You could otherwise fail to recognize dangers.

However, no system available today can completely eliminate injuries and fatalities in every accident situation. In particular, the seat belt and air bag generally do not protect against objects penetrating the vehicle from the outside. It is also not possible to completely rule out the risk of injury caused by the air bag deploying.

Mercedes-Benz recommends that you have the vehicle towed to a qualified specialist workshop after an accident. Take this into account, particularly if a Emergency Tensioning Device has been triggered or an air bag deployed.

If the Emergency Tensioning Devices are triggered or an air bag is deployed, you will hear a bang, and a small amount of fine powder may also be released:

- The bang will not generally affect your hearing.
- In general, the fine powder released is not hazardous to health but may cause short-term breathing difficulties to persons suffering from asthma or other respiratory problems.

Provided it is safe to do so, leave the vehicle immediately or open the window in order to prevent breathing difficulties.

Air bags and pyrotechnic Emergency Tensioning Devices contain perchlorate material, which may require special handling or environmental protection measures. National guidelines regarding waste disposal must be observed. In California, see <https://dtsc.ca.gov/>. You can use the search function to find information on perchlorate, for example.

Information on the limited protection provided by the restraint system

Risk due to the incorrect behavior of vehicle occupants

Every vehicle occupant must make sure of the following in particular:

- They observe the information on the correct seat position (→ page 42).
- There are no heavy, sharp-edged or fragile objects in the pockets of their clothing. Store such objects in a suitable place.

⚠ WARNING Risk of injury or death due to an incorrect seat position

The seat belt does not offer the intended level of protection if you have not moved the seat backrest to an almost vertical position.

In particular, you could slip beneath the seat-belt and become injured.

- ▶ Adjust the seat properly before beginning your journey.
- ▶ Always ensure that the seat backrest is in an almost vertical position and that the shoulder belt is routed across the center of your shoulder.

Risk due to objects in the vehicle interior

Every vehicle occupant must make sure of the following in particular:

- They observe the information on the correct seat position (→ page 42).
- There are no objects between the seat, door and door pillar (B-pillar).

- There are no hard objects, e.g. coat hangers, hanging on the grab handles or coat hooks.
- There are no heavy, sharp-edged or fragile objects in the pockets of their clothing. Store such objects in a suitable place.

⚠ WARNING Risk of injury or death due to blocked seat belt buckle or seat belt anchorage

Objects next to the front seat that block the seat belt buckle or the moving seat belt anchorage on the front seat impair the function of the Emergency Tensioning Devices.

- ▶ Before starting the journey, make sure that there are no objects around the seat belt buckle or between the front seat and door.

⚠ WARNING Risk of injury from objects in the deployment area of an airbag

Objects in the deployment area of an airbag can hinder or prevent the correct deployment of the airbag.

The airbag may then deploy in an uncontrolled manner and may even cause additional injuries to the vehicle occupants by deploying. This may be the case in particular if the airbag is integrated into the seat.

- ▶ Always stow and secure objects correctly.
- ▶ Before commencing your journey, make sure that no objects are stowed in the deployment area of an airbag.

The installation location of an air bag is identified by the AIRBAG (→ page 57) symbol.

Risk due to installation of accessories

Do not attach accessories such as mobile navigation devices, mobile phones or cup holders within the deployment area of an air bag, e.g. on the cockpit, on the door, on the side window or on the side trim.

In addition, no connecting cables, tensioning straps or retaining straps may be routed or attached to the vehicle within the deployment area of an air bag. Always comply with the accessory manufacturer's installation instructions and,

in particular, the notes on suitable places for installation.

⚠ WARNING Risk of injury or death due to unsuitable protective covers

Unsuitable protective covers mean that air bags can no longer protect vehicle occupants as they are designed to do.

- ▶ Use only protective covers approved by Mercedes-Benz for the seat in question.

In addition, the function of the automatic front passenger air bag shutoff could be restricted due to an unsuitable protective cover. If the front passenger seat is occupied, ensure that the PASSENGER AIR BAG indicator lamps display the correct status of the front passenger air bag (→ page 46).

Risk due to pets in the vehicle interior

⚠ WARNING Risk of accident and injury due to animals left unsecured or unattended in the vehicle

If you leave animals in the vehicle unattended or unsecured, they could possibly press buttons or switches.

An animal may:

- Activate vehicle equipment and become trapped, for example
- Switch systems on or off and endanger other road users

Unsecured animals may be thrown around in the vehicle in the event of an accident or sudden steering and braking maneuvers and injure vehicle occupants in the process.

- ▶ Never leave animals in the vehicle unattended.
- ▶ Always correctly secure animals while driving, e.g. using a suitable animal carrier.

Risk due to modification, damage or wear to the components of the restraint system

! **NOTE** Mercedes-AMG vehicles

- ▶ Observe the notes in the Supplement. You could otherwise fail to recognize dangers.

⚠ WARNING Risk of injury or death due to modifications to the restraint system

Vehicle occupants may no longer be protected as intended if alterations are made to the restraint system.

- ▶ Never alter the parts of the restraint system.
- ▶ Never tamper with the wiring or any electronic component parts or their software.

If it is necessary to modify the vehicle to accommodate a person with disabilities, contact an authorized Mercedes-Benz Center for details.

USA only: for details, contact our Customer Assistance Center on 1-800-FOR-MERCEdes (1-800-367-6372).

⚠ WARNING Risk of injury or death due to damaged or modified seat belts

Seat belts cannot provide protection in the following situations:

- The seat belt is damaged, has been modified, is extremely dirty, bleached or dyed
- The seat belt buckle is damaged or extremely dirty
- Modifications have been made to the Emergency Tensioning Device, seat belt anchorage or seat belt retractor

Seat belts may sustain non-visible damage in an accident, e.g. due to glass splinters.

Modified or damaged seat belts could tear or fail in the event of an accident, for example.

Modified Emergency Tensioning Devices could accidentally trigger or fail to function as intended.

- ▶ Never modify the seat belt system, for example the seat belt, seat belt buckle, Emergency Tensioning Device, seat belt anchorage and seat belt retractor.
- ▶ Make sure that the seat belts are undamaged, not worn and clean.
- ▶ Always have the seat belts checked immediately after an accident at a qualified specialist workshop.

Use only seat belts that have been approved for your vehicle by Mercedes-Benz. The seat is designed for the standard three-point seat belt. If you install a different multipoint seat belt, such as a four-point seat belt, the restraint system will not be able to provide the intended level of protection.

Depending on the type of vehicle, there may be openings in the seat backrest. These openings have no function.

⚠ WARNING Risk of injury or fatal injury due to modified seat belt systems

If you feed seat belts through the opening in the seat backrest, the seat backrest may be damaged or may even break in the event of an accident.

- ▶ Only use the standard three-point seat belt.
- ▶ Never modify the seat belt system.

⚠ WARNING Risk of injury due to modifications to the cover of an airbag

If you change the cover of an airbag or attach objects, e.g. even stickers, to it, the airbag may no longer function as intended.

- ▶ Never modify the cover of an airbag.
- ▶ Do not attach any objects to the cover.

The installation location of an air bag is identified by the AIRBAG symbol (→ page 57).

⚠ WARNING Risk of injury due to malfunctioning sensors in the door

The function of the airbags can be impaired due to modifications or incorrect work performed on the doors or door trim, or if the doors are damaged.

- ▶ Never modify the doors or parts of the doors.
- ▶ Always have work on the doors or door trim carried out at a qualified specialist workshop.

Risk due to components of the restraint system that have already been deployed

Mercedes-Benz recommends that you have the vehicle towed to a qualified specialist workshop after an accident.

⚠ WARNING Risk of burns from hot air bag components

The air bag parts are hot after an air bag has been deployed.

- ▶ Do not touch the air bag parts.
- ▶ Have a deployed air bag replaced at a qualified specialist workshop as soon as possible.

⚠ WARNING Risk of injury due to deployed airbag

A deployed airbag no longer offers any protection.

- ▶ Have the vehicle towed to a qualified specialist workshop in order to have the deployed airbag replaced.

Have deployed air bags replaced immediately.

⚠ WARNING Risk of injury or death from deployed pyrotechnic Emergency Tensioning Devices

Pyrotechnic Emergency Tensioning Devices that have been deployed are no longer operational and are unable to perform their intended protective function.

- ▶ Therefore, have deployed pyrotechnic Emergency Tensioning Devices immediately replaced at a qualified specialist workshop.

Seat belts

Releasing the seat belts

- ▶ Press the release button in the seat belt buckle and guide the seat belt back with the seat belt tongue.

! **NOTE** Damage caused by trapping the seat belt

If an unused seat belt is not fully retracted, it may become trapped in the door or in the seat mechanism.

- ▶ Always ensure that an unused seat belt is fully retracted.

Airbags

Overview of air bags

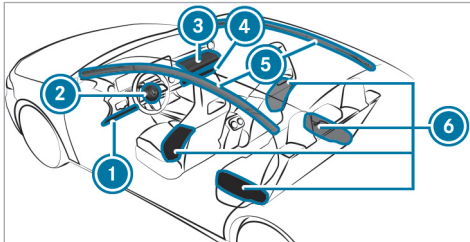

- ① Driver's knee air bag
- ② Driver's air bag
- ③ Front passenger air bag
- ④ Front passenger knee air bag
- ⑤ Window curtain air bag
- ⑥ Side impact air bag

The installation location of an air bag is identified by the AIRBAG symbol.

Observe the information under "Overview of deployment situations" (→ page 51).

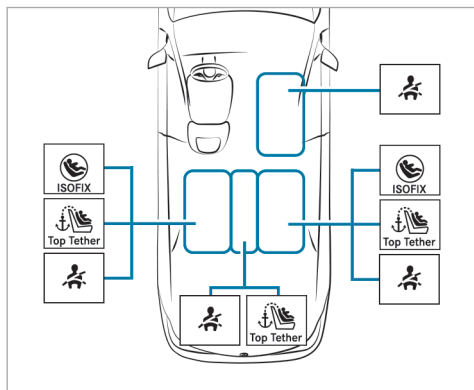
Key facts in brief**Safely transporting children in the vehicle**



Always observe the following when transporting children:

- Never leave children unattended in the vehicle (→ page 60).



- Secure children younger than twelve or of a height up to 5 ft (1.50 m) on the seat (see illustration above) properly with a suitable and approved child restraint system and secure small children in a rearward-facing child restraint system.
- Observe the child restraint system manufacturer's installation instructions.

Left/right rear seat (preferred seats)

Preferred fastening system:

-  ISOFIX mounting brackets (→ page 67)
-  and additionally fasten Top Tether if available (→ page 68).

Alternative attachment system:

-  Vehicle seat belt (→ page 70)
-  Additionally fasten Top Tether if recommended by the manufacturer of the child restraint system (→ page 68).

Front passenger seat

Fastening system:



-  Vehicle seat belt (→ page 70)

Be sure to observe:

- If the front passenger seat is occupied, ensure that the status of the front passenger air bag is correct for the current situation (→ page 46).

Rear center seat

Fastening system:

-  Vehicle seat belt (→ page 70)
-  Additionally fasten Top Tether if recommended by the manufacturer of the child restraint system (→ page 68).

Important safety notes**Basic information****Be diligent**

Bear in mind that negligence when securing a child in the child restraint system may have seri-

ous consequences. Always be diligent in securing a child carefully before every journey.

Never allow babies and children to travel sitting on the lap of another vehicle occupant.

To improve protection for children younger than twelve years old or under 5 ft (1.50 m) in height, Mercedes-Benz recommends you observe the following information:

- Always secure the child in a child restraint system suitable for this Mercedes-Benz vehicle.
- The child restraint system must be appropriate to the age, weight and size of the child.
- The vehicle seat must be suitable for the child restraint system to be installed:

Accident statistics show that children secured on the rear seats are generally safer than children secured on the front seats. For this reason, Mercedes-Benz strongly advises that you install a child restraint system to a rear seat.

The generic term child restraint system

The generic term child restraint system is used in this Operator's Manual. A child restraint system is, for example:

- a baby car seat
- a rearward-facing child seat
- a forward-facing child seat
- a child booster seat – Mercedes-Benz recommends using a child booster seat **with** a seat backrest and seat belt guide.

Observe laws and legal requirements

Always observe the legal requirements when using a child restraint system in the vehicle.

Securing systems for child restraint systems in the vehicle

Use only the following securing systems for child restraint systems:

- The ISOFIX mounting bracket
- The vehicle's seat belt system
- The Top Tether anchorages

Simply attaching to the ISOFIX mounting brackets on the vehicle can reduce the risk of installing the child restraint system incorrectly.

When securing a child with the integrated seat belt of the ISOFIX/LATCH child restraint system, always comply with the permissible gross weight for the child and child restraint system (→ page 67).

A child booster seat may be necessary to achieve proper seat belt positioning for children over 40 lbs (18 kg) in weight or until they reach a height where a three-point seat belt can be installed properly without a child booster seat.

Mercedes-Benz recommends a suitable child booster seat with a backrest and seat belt guide.

Observe standards for child restraint systems

All child restraint systems must meet the following standards:

- U.S. Federal Motor Vehicle Safety Standards 213
- Canadian Motor Vehicle Safety Standards 213

Confirmation that the child restraint system complies with the standards can be found on an information label on the child restraint system. This confirmation can also be found in the installation instructions that are included with the child restraint system.

Important warning stickers

Always secure a child restraint system correctly

⚠ WARNING Risk of injury or death due to incorrect installation of the child restraint system

The child can then not be protected or restrained as intended.

- ▶ Be sure to comply with the manufacturer's installation instructions for the child restraint system and its correct use.
- ▶ Make sure that the entire base of the child restraint system always rests on the sitting surface of the seat.

- ▶ Never place objects (e.g. cushions) under or behind the child restraint system.
- ▶ Use child restraint systems only with the original cover designed for them.
- ▶ Always replace damaged covers with genuine covers.

- Always observe the vehicle-specific information.
 - Installing the ISOFIX/LATCH child restraint system on the right and left rear seats (→ page 67).
 - Securing the child restraint system with the seat belt (→ page 70).
- Observe the warning labels in the vehicle interior and on the child restraint system.

⚠ WARNING Risk of injury or death due to unsecured child restraint systems in the vehicle

If the child restraint system is incorrectly mounted or unsecured, it may come loose.

The child can then not be protected or restrained as intended.

Unused child restraint systems could be flung around and hit vehicle occupants.

- ▶ Always comply with the manufacturer's installation instructions for the child restraint system and its correct use.
- ▶ Always fit child restraint systems correctly, even if they are transported in the vehicle unused.

Do not modify the child restraint system

⚠ WARNING Risk of injury due to modifications to the child restraint system

The child restraint system can no longer function properly. This poses an increased risk of injury.

- ▶ Never modify a child restraint system.
- ▶ Only affix accessories which have been specially approved for this child restraint system by the child restraint system's manufacturer.

Only use child restraint systems which are in proper working condition

⚠ WARNING Risk of injury or death caused by the use of damaged child restraint systems

Child restraint systems or their retaining systems that have been subjected to stress in an accident may not be able to perform their intended protective function.

It may be the case that the child cannot be properly restrained.

- ▶ Always immediately replace child restraint systems that have been damaged or involved in an accident.
- ▶ Have the securing systems for the child restraint systems checked at a qualified specialist workshop before installing a child restraint system again.

Avoid direct sunlight

⚠ WARNING Risk of burns when the child seat is exposed to direct sunlight

If the child restraint system is exposed to direct sunlight or heat, parts could heat up excessively.

Children could suffer burns from these parts, particularly the metallic parts of the child restraint system.

- ▶ Always make sure that the child restraint system is not exposed to direct sunlight.
- ▶ Cover the child restraint system with a blanket, for example.
- ▶ If the child restraint system has been exposed to direct sunlight, allow it to cool before securing a child into it.
- ▶ Never leave children unattended in the vehicle.

Observe when stopping or parking

⚠ WARNING Risk of fatal injury due to exposure to extreme heat or cold in the vehicle

If persons, particularly children, are subjected to prolonged exposure to intense heat or cold, there is a risk of severe injury or even death.

- ▶ Never leave persons, particularly children, unattended in the vehicle.

⚠ WARNING Risk of accident and injury if children are left unattended in the vehicle

If children are left unattended in the vehicle, they could in particular:

- open doors, thereby endangering other persons or road users.
- get out and be struck by oncoming traffic.
- operate vehicle equipment and become trapped, for example.

In addition, the children could also set the vehicle in motion, for example by:

- releasing the parking brake.
- changing gear.
- starting the vehicle.

- ▶ Never leave children unattended in the vehicle.
- ▶ When leaving the vehicle, always take the SmartKey with you and lock the vehicle.
- ▶ Keep the SmartKey out of the reach of children.

Notes on rearward-facing and front-facing child restraint systems on the front passenger seat

▲ WARNING Risk of injury or fatal injury when using a rearward-facing child restraint system while the co-driver airbag is enabled

If you secure a child in a rearward-facing child restraint system on the co-driver seat and the

PASSENGER AIR BAG OFF indicator lamp is off, the co-driver airbag can deploy in the event of an accident.

The child could be struck by the airbag.

- ▶ Always ensure that the co-driver airbag is disabled. The PASSENGER AIR BAG OFF indicator lamp must be lit.
- ▶ NEVER use a rearward-facing child restraint system on a seat with an ENABLED FRONT AIRBAG; DEATH or SERIOUS INJURY to the CHILD can occur.

Observe the specific instructions for the rearward-facing and forward-facing child restraint systems (→ page 64).

If it is absolutely necessary to install a child restraint system on the front passenger seat, always observe the following information:

- When a rearward-facing child restraint system is used on the front passenger seat, the front passenger air bag must always be disabled. This is the case only if the PASSENGER AIR

BAG OFF indicator lamp is lit continuously (→ page 46).

- The front passenger air bag is enabled when the PASSENGER AIR BAG OFF indicator lamp is not lit. The front passenger air bag may be deployed during an accident. In that case, do not use rearward-facing child restraint systems.

Information on the automatic front passenger air bag shutoff

If the front passenger seat is occupied, ensure, both before and during the journey, that the status of the front passenger air bag is correct for the current situation.

▲ WARNING Risk of injury or death due to objects between the seat surface and the child restraint system

Objects between the seat surface and the child restraint system can interfere with the function of the automatic front passenger air bag shutoff.

- ▶ Do not place any objects between the seat surface and the child restraint system.
- ▶ Make sure that the entire base of the child restraint system rests on the seat cushion of the front passenger seat.
- ▶ The backrest of a forward-facing child restraint system must, as far as possible, be resting against the seat backrest of the front passenger seat.
- ▶ Always comply with the installation instructions from the child restraint system manufacturer.

When installing a child restraint system to the front passenger seat, observe the vehicle-specific information (→ page 62).

Rearward-facing child restraint system on the front passenger seat

If a rearward-facing child restraint system is installed on the front passenger seat, the front passenger air bag must be deactivated. The PASSENGER AIR BAG OFF indicator lamp must light up continuously (→ page 46).

⚠ WARNING Risk of injury or fatal injury when using a rearward-facing child restraint system while the co-driver airbag is enabled

If you secure a child in a rearward-facing child restraint system on the co-driver seat and the PASSENGER AIR BAG OFF indicator lamp is off, the co-driver airbag can deploy in the event of an accident.

The child could be struck by the airbag.

- ▶ Always ensure that the co-driver airbag is disabled. The PASSENGER AIR BAG OFF indicator lamp must be lit.
- ▶ NEVER use a rearward-facing child restraint system on a seat with an ENABLED FRONT AIRBAG; DEATH or SERIOUS INJURY to the CHILD can occur.

- ⓘ The front passenger air bag is enabled depending on the child restraint system and the stature of the child. The PASSENGER AIR BAG OFF indicator lamp does not light up. The front passenger air bag may be deployed during an accident. If the front passenger air

bag is in this status, no rearward-facing child restraint system may be installed on the front passenger seat. Instead, install the rearward-facing child restraint system on a suitable rear seat.

Forward-facing child restraint system on the front passenger seat

If a forward-facing child restraint system is installed on the front passenger seat, the front passenger air bag may be automatically enabled or disabled. The status of the front passenger air bag depends on the child restraint system and the stature of the child.

The PASSENGER AIR BAG OFF indicator lamp is either lit continuously, or it is not lit (→ page 46). Always observe the following information.

⚠ WARNING Risk of injury or death caused by incorrect positioning of the child restraint system

If you secure a child in a forward-facing child restraint system on the front passenger seat and you position the front passenger seat too close to the cockpit, in the event of an accident, the child could:

- Come into contact with the vehicle interior if the PASSENGER AIR BAG OFF indicator lamp is lit, for example.
- Be struck by the air bag if the PASSENGER AIR BAG OFF indicator lamp is off.

▶ Always move the front-passenger seat as far back as possible. Always make sure that the shoulder belt strap is correctly routed from the seat belt outlet of the vehicle to the shoulder belt guide on the child restraint system. The shoulder belt strap must be routed forwards and downwards from the seat belt outlet. If

necessary, adjust the front-passenger seat accordingly.

▶ Always comply with the child restraint system manufacturer's installation instructions.

Be sure to also observe the following further related topics:

- Function of the automatic front passenger air bag shut-off (→ page 46)

Suitable child restraint systems for the transport of children

Information on the advantage of a rearward-facing child restraint system

Transport a baby in a suitable rearward-facing child restraint system only. It is also preferable to transport a small child in a suitable rearward-facing child restraint system. In this case, the child sits in the opposite direction to the direction of travel and faces backwards.

Babies and small children have comparatively weak neck muscles in relation to the size and weight of their head. The risk of injury to the cervical spine during an accident can be reduced in a rearward-facing child restraint system.

Securing the child restraint system

Adjusting the seat correctly

When installing a child restraint system on the left or right rear seat, always observe the following:

▶ Make sure that the child's feet do not touch the front seat. If necessary, move the front seat slightly forwards.

If the head restraint of the child restraint system cannot be fully extended when it is installed in the vehicle, this will result in restrictions on the maximum size setting for certain child restraint systems. Observe the child restraint system manufacturer's installation instructions.

ⓘ Contact with the roof when the head restraint is fully extended and locked in place will not result in any restrictions on use.

 Also observe the following when installing an ISOFIX child restraint system:

- ▶ **When using a rearward-facing child restraint system on a rear seat:** adjust the front seat such that it does not touch the child restraint system.
- ▶ **When using a forward-facing child restraint system with integrated child seat belt:** adjust the head restraint of the respective seat such that it does not push the child restraint system forwards. If necessary, the corresponding head restraint can be removed. In addition, the seat backrest of the child restraint system must lie as flat as possible against the backrest of the vehicle seat. After the child restraint system has been removed, replace the vehicle head restraint immediately and adjust it correctly.
- ▶ The child restraint system must not be put under strain between the roof and the seat cushion and/or be installed facing in the wrong direction. Where possible, adjust the seat cushion angle accordingly.

- ▶ Adjust the vehicle head restraints such that the child restraint system is not put under strain by the head restraint.

 **When installing a belt-secured child restraint system, also observe the following:**

- ▶ **When using a rearward-facing child restraint system on a rear seat:** adjust the front seat such that it does not touch the child restraint system.
- ▶ Additionally fasten Top Tether if present (→ page 68).
- ▶ **When using a forward-facing child restraint system with integrated child seat belt:** adjust the head restraint of the respective seat such that it does not push the child restraint system forwards. If necessary, the corresponding head restraint can be removed. In addition, the seat backrest of the child restraint system must lie as flat as possible against the backrest of the vehicle seat. After the child restraint system has been removed, replace the vehicle head restraint immediately and adjust it correctly.

- ▶ The backrest of the forward-facing child restraint system must, as far as possible, be resting on the seat backrest of the rear seat.
- ▶ The child restraint system must not be put under strain between the roof and the seat cushion and/or be installed facing in the wrong direction. Where possible, adjust the seat cushion angle accordingly.
- ▶ Adjust the vehicle head restraints such that the child restraint system is not put under strain by the head restraint.
- ▶ Make sure that the child's feet do not touch the front seat. If necessary, move the front seat slightly forwards.

 **Depending on the vehicle equipment, always observe the following when installing a belt-secured child restraint system on the front passenger seat:**

- ▶ Observe the notes on rearward-facing and forward-facing child restraint systems on the front passenger seat (→ page 62).
- ▶ **When using a forward-facing child restraint system integrated child seat belt:** remove the

head restraint from the front passenger seat, if possible. After the child restraint system has been removed, immediately replace the head restraint and adjust it correctly.

- ▶ The backrest of the forward-facing child restraint system must, as far as possible, be resting on the seat backrest of the front passenger seat.
- ▶ The child restraint system must not be put under strain between the roof and the seat cushion and/or be installed facing in the wrong direction.
- ▶ Adjust the vehicle head restraints such that the child restraint system is not put under strain by the head restraint.
- ▶ Never place objects (e.g. cushions) under or behind the child restraint system.
- ▶ Set the front passenger seat as far back as possible and move the seat into the highest position if possible. Always make sure that the shoulder belt strap is correctly routed from the seat belt outlet of the vehicle to the shoulder belt guide on the child restraint system. The shoulder belt strap must be routed for-

wards from the seat belt outlet and, where possible, downwards to the child restraint system.

- ▶ Fully retract the seat cushion length adjustment.
- ▶ Adjust the seat cushion inclination such that the front edge of the seat cushion is in the highest position and the rear edge of the seat cushion is in the lowest position.
- ▶ Set the seat backrest to the most vertical position possible.

Activating/deactivating the child seat safety feature of the seat belt

⚠ WARNING Risk of injury or death if a seat belt is unfastened while the vehicle is in motion

If the seat belt is released while the vehicle is in motion, the special seat belt retractor is deactivated and the child restraint system is no longer correctly secured. The seat belt is

drawn in slightly by the inertia reel and cannot be immediately closed again.

- ▶ Stop the vehicle immediately in accordance with the traffic conditions.
- ▶ Activate the special seat belt retractor again and correctly secure the child restraint system.

When enabled, the child seat safety feature ensures that the seat belts of the front passenger seat and rear seats do not slacken once the child restraint system is secured.

The seat belts on the following seats are equipped with a child seat safety feature:

- Front passenger seat
- Rear seats

Installing a child restraint system

- ▶ When installing a child restraint system, always observe the manufacturer's installation and operating instructions as well as the information in this Operator's Manual.

- ▶ Pull the seat belt smoothly from the seat belt outlet.
- ▶ Engage the seat belt tongue in the seat belt buckle.

Activating the child seat safety feature:

- ▶ Pull the seat belt out fully and let the inertia reel retract it again. When the child seat safety feature is activated, you should hear a ratcheting sound.
- ▶ Push the child restraint system down until the seat belt sits tightly.

Deactivating the child seat safety feature:

- ▶ Press the release button of the seat belt buckle.
- ▶ Hold the seat belt tongue and guide it back to the seat belt outlet.

Installing an ISOFIX/LATCH child restraint system

- ▲ WARNING** Risk of accident if the rear bench seat, rear seat and seat backrest are not engaged

The rear bench seat, rear seat and seat backrest may fold forwards, even when you are driving.

- As a result, the vehicle occupant will be pushed into the seat belt with increased force. The seat belt will not be able to protect as intended and could cause additional injury.
 - Objects or loads in the trunk or cargo compartment will not be restrained by the seat backrest.
- ▶ Make sure that the rear bench seat, the rear seat and the seat backrest are engaged before every trip.

If the rear seat backrest is not engaged and locked in place, the red lock verification indicator will be visible.

- ▲ WARNING** Risk of injury or death if the permissible gross mass of the child and child restraint system together is exceeded.

Too much load may be placed on the LATCH-type (ISOFIX) or iSize child restraint systems and the child may not be restrained correctly in the event of an accident, for example.

- ▶ If the child is secured in a LATCH-type (ISOFIX) child restraint system with integrated seat belt, the total mass of the child and child restraint system must not exceed 73 lb (33 kg).

Always observe the information on the mass of the child:

- in the installation instructions and Operator's Manual of the manufacturer of the child restraint system used
- on a label on the child restraint system, if present

Regularly check that the permissible total mass of the child and child restraint system is still being adhered to.

When installing a child restraint system, also observe the following:

- ☑ Always observe the area of use and the suitability of the seats for attaching a child restraint system.

LATCH-type (ISOFIX) mounting brackets

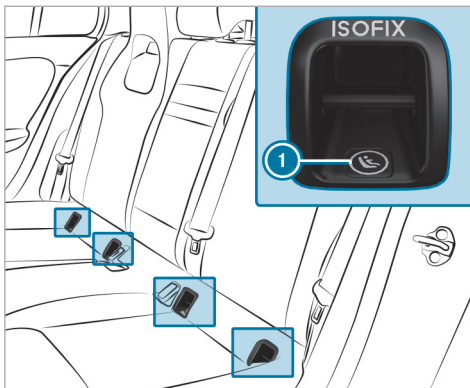

① ISOFIX mounting bracket

- ▶ Before every journey always ensure that the ISOFIX/LATCH child restraint system is correctly engaged in both mounting brackets on the vehicle.

❗ **NOTE** Damage to the seat belt for the center seat during installation of the child restraint system

- ▶ Make sure that the seat belt is not trapped.

- ▶ Attach the ISOFIX/LATCH child restraint system to both mounting brackets in the vehicle.

Fastening a Top Tether

⚠ **WARNING** Risk of injury or death if the rear seat backrests are not locked after Top Tether belts are installed

The rear seat backrests may fold forwards when you are driving.

As a result, child restraint systems will no longer be able to perform their intended protective function. This may also cause additional injuries.

- ▶ Always lock rear seat backrests after installing Top Tether belts.

- ▶ Observe the lock verification indicator.

If the rear seat backrest is not engaged and locked in place, the red lock verification indicator will be visible.

-  If the child restraint system is equipped with a Top Tether belt:

The risk of injury may be reduced by Top Tether. The Top Tether belt enables an additional connection between the child restraint system attached with ISOFIX (left and right rear seats) or the seat belt (all rear seats) and the vehicle.

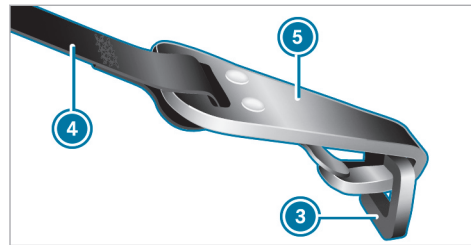
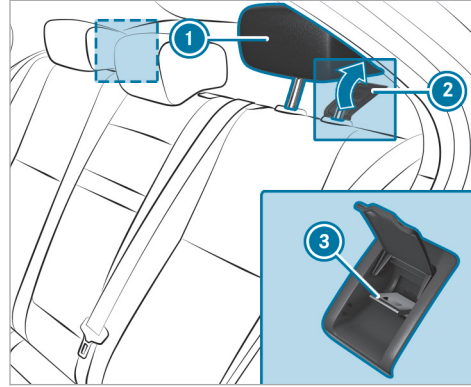

- ▶ Fold up cover ② of Top Tether anchorage ③.

Vehicles with adjustable head restraints:

- ▶ If necessary, slide head restraint ① upwards (→ page 105).
- ▶ Guide Top Tether belt ④ under head restraint ① between the two head restraint bars.

Vehicles without adjustable head restraints:

- ▶ Top Tether belt with one seat belt strap: guide Top Tether belt ④ past head restraint ① on the side nearest the door.
- or
- ▶ Top Tether belt with two seat belt straps: guide one Top Tether belt ④ past head restraint ① on the right and left sides respectively.

All vehicles:

- ▶ Install the ISOFIX/LATCH or belt-secured child restraint system with Top Tether. Comply with the child restraint system manufacturer's installation instructions.

- ▶ Hook Top Tether hook ⑤ of Top Tether belt ④ into Top Tether anchorage ③ without twisting.
- ▶ Tension Top Tether belt ④. Comply with the child restraint system manufacturer's installation instructions.
- ▶ Fold down cover ② of Top Tether anchorage ③.

Vehicles with adjustable head restraints:

- ▶ If necessary, slide head restraint ① downwards (→ page 105). Make sure that you do not interfere with the correct routing of Top Tether belt ④.

Fastening the child restraint system with the seat belt

⚠ WARNING Risk of accident if the rear bench seat, rear seat and seat backrest are not engaged

The rear bench seat, rear seat and seat backrest may fold forwards, even when you are driving.

- As a result, the vehicle occupant will be pushed into the seat belt with increased force. The seat belt will not be able to protect as intended and could cause additional injury.
- Objects or loads in the trunk or cargo compartment will not be restrained by the seat backrest.

▶ Make sure that the rear bench seat, the rear seat and the seat backrest are engaged before every trip.

If the rear seat backrest is not engaged and locked in place, the red lock verification indicator will be visible.

The seat belts on the following seats are equipped with a special seat belt retractor:

- Front passenger seat
- Rear seats

When enabled, the special seat belt retractor ensures that the seat belts of the front passenger seat and rear seats do not slacken once the child restraint system is secured.

- ▶ For a child restraint system of the category "Universal" or "Semi-Universal" ensure that this is approved for the vehicle seat.
- ▶ Install the child restraint system. The entire base of the child restraint system must always rest on the sitting surface of the seat.
- ▶ Always make sure that the shoulder belt strap is correctly routed from the seat belt outlet of the vehicle to the shoulder belt guide on the child restraint system. The shoulder belt strap must be routed forwards from the seat belt outlet and, where possible, downwards to the child restraint system.

- ▶ **Installation on the rear seat:** also secure Top Tether, if present.
- ▶ **Installation on the front passenger seat:** if necessary, adjust the seat belt outlet and the front passenger seat appropriately.

Child safety locks

Activating/deactivating the child safety lock for the rear doors

⚠ WARNING Risk of accident and injury if children are left unattended in the vehicle

If children are left unattended in the vehicle, they could in particular:

- open doors, thereby endangering other persons or road users.
- get out and be struck by oncoming traffic.
- operate vehicle equipment and become trapped, for example.

In addition, the children could also set the vehicle in motion, for example by:

- releasing the parking brake.
- changing gear.
- starting the vehicle.

- ▶ Never leave children unattended in the vehicle.
- ▶ When leaving the vehicle, always take the SmartKey with you and lock the vehicle.
- ▶ Keep the SmartKey out of the reach of children.

⚠ WARNING Risk of fatal injury due to exposure to extreme heat or cold in the vehicle

If persons, particularly children, are subjected to prolonged exposure to intense heat or cold, there is a risk of severe injury or even death.

- ▶ Never leave persons, particularly children, unattended in the vehicle.

⚠ WARNING Risk of accident and injury due to children left unattended in the vehicle

If children are traveling in the vehicle, they could, in particular:

- Open doors, thereby endangering other persons or road users.
- Get out and be struck by oncoming traffic.
- Operate vehicle equipment and become trapped, for example.
- ▶ Always activate the installed child safety locks if children are traveling in the vehicle.
- ▶ Never leave children unattended in the vehicle.
- ▶ When leaving the vehicle, always take the SmartKey with you and lock the vehicle.

There are child safety locks for the rear doors and the rear side windows.

The child safety locks on the rear doors secure each door separately. The doors can no longer be opened from the inside.

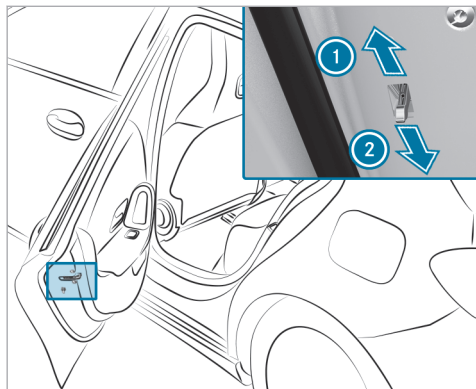

- ▶ Press the lever in direction ① (activate) or ② (deactivate).
- ▶ Check the functionality of the child safety lock.

Activating and deactivating the child safety lock for the rear side windows

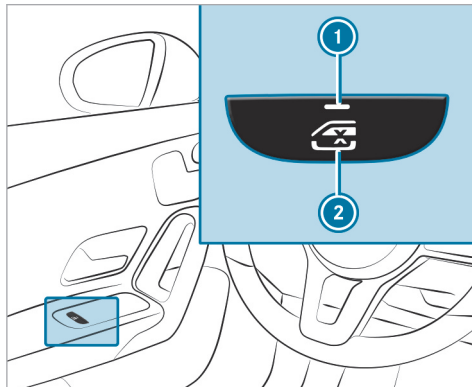

- ▶ **To activate/deactivate:** press button ②.

The rear side window can be opened or closed as follows:

- Indicator lamp ① is lit: via the switch on the driver's door

- Indicator lamp ① is off: via the switch on the corresponding rear door or driver's door

Occupant presence reminder

Function of the occupant presence reminder

The occupant presence reminder can help to remind you about a child who may have been forgotten in the rear passenger compartment of the vehicle. It activates and deactivates automatically when the rear door is open for an extended period of time and a child, which the system presumes to be present, could enter or exit the vehicle.

When the vehicle is switched off, the **Do Not Leave People or Animals in the Vehicle** message appears on the driver display if the system was already automatically activated.

You can permanently deactivate the function in the multimedia system (→ page 73). When the system is deactivated, the  indicator lamp in the driver display lights up.

Activating or deactivating the occupant presence reminder in the multimedia system

Multimedia system:

-  ➤ Settings ➤ Vehicle
- Occupant Protection
- ▶ Activate or deactivate the function.

SmartKey

Overview of SmartKey functions

⚠ WARNING Risk of accident and injury due to children left unattended in the vehicle

If you leave children unattended in the vehicle, they could, in particular:

- open doors, thereby endangering other persons or road users.
- get out and be struck by oncoming traffic.
- operate vehicle equipment and become trapped, for example.

In addition, the children could also set the vehicle in motion by, for example:

- releasing the parking brake.
- changing the gearbox position.
- starting the vehicle.

▶ Never leave children unattended in the vehicle.

- ▶ When leaving the vehicle, always take the key with you and lock the vehicle.
- ▶ Keep the key out of reach of children.

! **NOTE** Damage to the SmartKey caused by magnetic fields



- ▶ Keep the SmartKey away from strong magnetic fields.



Vehicle key with panic alarm

- ① Locks
- ② Indicator lamp
- ③ Unlocks

- ④ Opens the trunk lid
- ⑤ Panic alarm

i If indicator lamp ② does not light up when the  or  button is pressed, the battery is weak or possibly discharged. Replace the battery as soon as possible.

Replace the SmartKey battery (→ page 76).

The SmartKey locks and unlocks the following components:

- Doors
- Fuel filler flap
- Trunk lid

If the vehicle is not opened within approximately 40 seconds after unlocking, it locks again. Anti-theft protection is armed again.

Do not keep the SmartKey together with electronic devices or metal objects. This can affect the SmartKey's functionality.

Activating/deactivating the acoustic locking verification signal

Multimedia system:

→ [Home] » Settings » Vehicle
» Open/Close

- ▶ Switch the **Acoustic Lock** on or off.

Activating/deactivating the panic alarm

Requirements

- The vehicle is switched off.



- ▶ **To activate:** press button ① for approximately one second.

A visual and audible alarm is triggered.

- ▶ **To deactivate:** briefly press button ① again.

or

- ▶ Press the start/stop button.
A key belonging to the vehicle must be detected in the vehicle.

Changing the unlocking settings

Possible unlocking functions of the key:

- Central unlocking
- Unlocking the driver's door and fuel filler flap

- ▶ **To switch between settings:** press the [Lock] and [Unlock] buttons simultaneously for approximately six seconds until the indicator lamp flashes twice.

Options if the unlocking function for the driver's door and fuel filler flap has been selected:

- **To unlock the vehicle centrally:** press the [Unlock] button twice.



- **Vehicles with KEYLESS-GO:** if you touch the inner surface of the door handle on the driver's door, only the driver's door and the fuel filler flap will be unlocked.

Deactivating the function of the key

Vehicles with KEYLESS-GO: if you deactivate the function of the SmartKey, the KEYLESS-GO functions will also be deactivated. Access or drive authorization by KEYLESS-GO will then no longer be possible with that particular SmartKey. Activate the function of the SmartKey so that all its functions will again be available.

You can also deactivate the function of the SmartKey to reduce the energy consumption of the SmartKey if you do not use the vehicle or a SmartKey for an extended period of time.

- ▶ Press and hold the [Lock] button on the SmartKey.

▶ With the key button  pressed, immediately press key button  twice in quick succession.

The indicator light of the key lights up once briefly and once for a long time.

❗ The following options for re-activating the SmartKey are available:

- Press any button on the SmartKey.
- Start the vehicle with the SmartKey in the marked space in the center console (→ page 143).

Removing/inserting the emergency key

Removing the emergency key

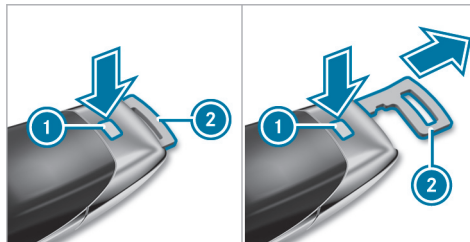

- ▶ Press the release knob ①.
The emergency key ② is pushed out slightly.
- ▶ Pull out the emergency key ② until it engages in the intermediate position.
- ❗ Depending on the vehicle's equipment, the intermediate position may not be available.
- ▶ Press the release knob ① again and fully remove the emergency key ②.

Inserting the emergency key

- ▶ Press the release knob ①.
- ▶ Insert the emergency key ② to the intermediate position, or fully until it engages.
- ❗ You can use the emergency key ② to attach the key to a key ring.
Depending on the respective configuration, it is possible to engage the emergency key ② in the intermediate position.

Replacing the key battery

⚠ DANGER Risk of fatal injury due to swallowing batteries

Batteries contain toxic and corrosive substances. If batteries are swallowed or otherwise enter the body, severe internal burns can occur within two hours.

There is a risk of fatal injury!

- ▶ Keep the batteries out of the reach of children.

- ▶ If the lid and/or the battery compartment do not close securely, stop using the key and keep it away from children.
- ▶ If batteries are swallowed or otherwise enter the body, seek immediate medical attention.

 **ENVIRONMENTAL NOTE** Environmental damage due to improper disposal of batteries



Batteries contain pollutants. It is illegal to dispose of them with the household rubbish.



Dispose of batteries in an environmentally responsible manner. Take discharged batteries to a qualified specialist workshop or to a collection point for used batteries.

Requirements

- You require a CR 2032 3 V cell battery.

Mercedes-Benz recommends that you have the battery replaced at a qualified specialist workshop.

- ▶ Remove the mechanical key (→ page 76).

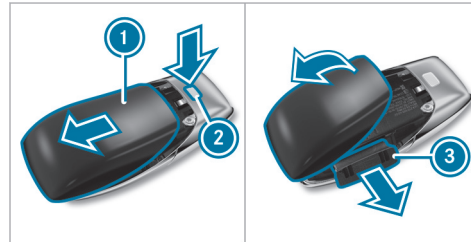

- ▶ Press release knob ② down fully and slide cover ① in the direction of the arrow.
- ▶ Fold out cover ① in the direction of the arrow and remove.
- ▶ Remove battery compartment ③ and take out the discharged battery.

- ▶ Insert the new battery into battery compartment ③. Observe the positive pole marking in the battery compartment and on the battery when doing this.
- ▶ Push in battery compartment ③.
- ▶ Re-attach cover ① and push it until it engages.

Problems with the key, troubleshooting

You can no longer lock or unlock the vehicle

Possible causes are:

- The key battery is weak or discharged.
- ▶ Check the battery using the indicator lamp (→ page 74).
- ▶ Replace the key battery, if necessary (→ page 76).
- ▶ Use the replacement key.
- ▶ Use the mechanical key to lock or unlock (→ page 81).
- ▶ Have key checked at a qualified specialist workshop.

There is interference from a powerful radio signal source

Possible causes if the function of the key is impaired:

- high voltage power lines
- mobile phones
- electronic devices (notebooks, tablets)
- shielding due to metal objects or induction loops for electrical gate systems or automatic barriers

▶ Make sure that there is sufficient distance between the key and the potential source of interference.

You have lost a key

- ▶ Have the key deactivated at a qualified specialist workshop.
- ▶ If necessary, have the mechanical lock replaced as well.

Doors

Unlocking/opening the doors from the inside

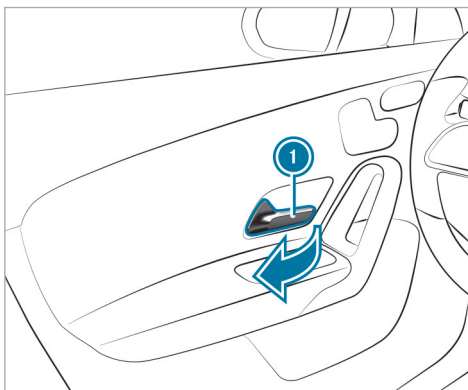

- ▶ **To unlock and open a front door:** pull door handle ①.
- ▶ **To unlock a rear door:** pull the rear door handle.
- ▶ **To open a rear door:** pull the rear door handle again.

Centrally locking and unlocking the vehicle from the inside

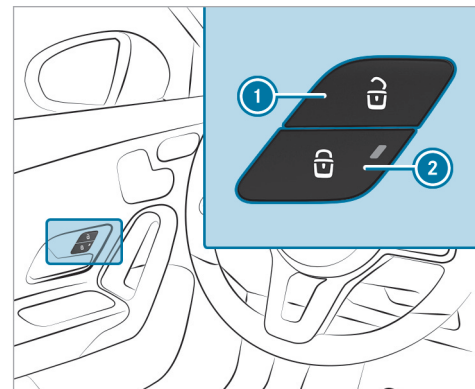

- ▶ **To unlock:** press the button ①.
 - ▶ **To lock:** press the button ②. The red indicator lamp on the button ② lights up when the vehicle is locked.
- ⓘ The buttons are also located on the front passenger door.

This does not lock or unlock the fuel filler flap.
The vehicle is not unlocked when the button ① is pressed:

- If you have locked the vehicle using the key
- If you have locked the vehicle using KEYLESS-GO

Locking/unlocking the vehicle with KEYLESS-GO

Requirements

- The key is outside the vehicle.
- The distance between the key and the vehicle does not exceed 3 ft (1 m).
- The driver's door and the door on which the door handle is used are closed.

1 **NOTE** Damage to the vehicle caused by unintentionally opening the trunk lid

- When using an automatic car wash
- When using a high pressure cleaner

- ▶ Deactivate the function of the SmartKey in these situations.
- or
- ▶ Make sure that the SmartKey is at a minimum distance of 10 ft (3 m) away from the vehicle.

Observe the notes:

- on washing the vehicle in a car wash (→ page 290)
- on using a high-pressure cleaner (→ page 292)

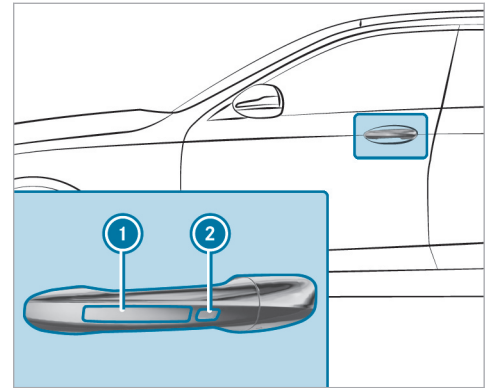

- ▶ **To unlock the vehicle:** touch the inner surface of the door handle.
- ▶ **To lock the vehicle:** touch sensor surface ① or ②.
- ▶ **Convenience closing:** touch recessed sensor surface ② until the closing process has been completed.

❗ Further information on convenience closing (→ page 88).

If you open the trunk lid from outside, the trunk lid is automatically unlocked.

Troubleshooting problems with KEYLESS-GO

You can no longer lock or unlock the vehicle using KEYLESS-GO

Possible causes:

- The function of the key has been deactivated.
- The key battery is weak or discharged.
- ▶ Activate the function of the key (→ page 75).
- ▶ Check the battery via the indicator lamp (→ page 74).
- ▶ If necessary, replace the key battery (→ page 76).
- ▶ Use the replacement key.
- ▶ Use the emergency key to lock or unlock (→ page 81).
- ▶ Have the vehicle and key checked at a qualified specialist workshop.

There is interference from a powerful radio signal source.

Possible causes if the function of KEYLESS-GO is impaired:

- high-voltage power lines
 - mobile phones
 - electronic devices (laptops, tablets)
 - shielding due to metallic objects or induction loops for electrical gate systems or automatic barriers
- ▶ Ensure that there is sufficient distance between the key and the potential source of interference.

Activating/deactivating the automatic locking feature

The vehicle will be locked automatically when the vehicle is switched on and the wheels are turning faster than walking pace.

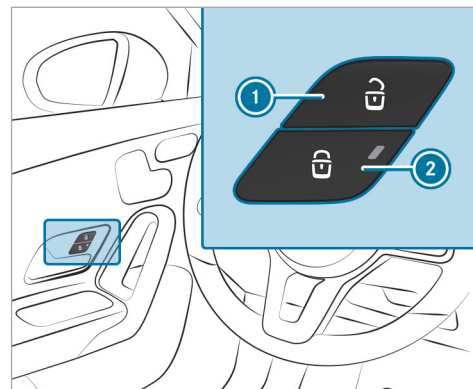

▶ **To activate:** press and hold button ② for approximately five seconds until a tone sounds.

▶ **To deactivate:** press and hold button ① for approximately five seconds until a tone sounds.

The red indicator lamp on button ② will light up when the vehicle is locked.

In the following situations, there is a danger of being locked out when the function is activated:

- while the vehicle is being tow started or pushed
- if the vehicle is being tested on a roller dynamometer

Activating/deactivating automatic locking in the MBUX multimedia system

Multimedia system:

→  → Settings → Vehicle
→ Open/Close

- ⓘ The vehicle will be locked automatically when the vehicle is switched on and the wheels are turning faster than walking pace.
- ▶ Activate or deactivate **Automatic Door Lock**.

In the following situations, there is a risk of being locked out when the function is activated:

- The vehicle is being towed or pushed.
- The vehicle is being tested on a roller dynamometer.

Locking/unlocking the vehicle with the emergency key

Locking/unlocking the driver's door with the emergency key

- ⓘ If you wish to lock the vehicle entirely using the emergency key, first press the button for locking from the inside while the driver's door is open. Then proceed to lock the driver's door using the emergency key.
- ⓘ If you unlock and open the driver's door with the emergency key, this will trigger the anti-theft alarm system.
- ⓘ Information regarding starting the vehicle with the key in the marked space (emergency operation mode) (→ page 143).

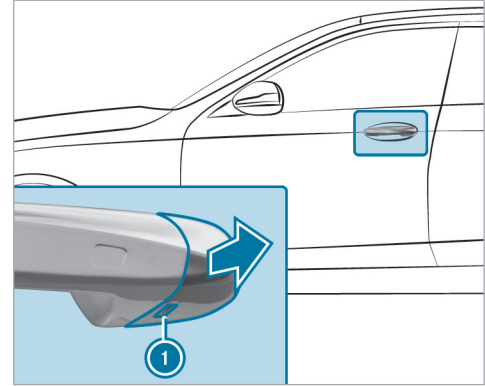

- ▶ Remove the emergency key (→ page 76).
- ▶ Insert the emergency key as far as it will go into opening ① on the cover cap.
- ▶ Pull and hold the door handle.
- ▶ Pull the cover cap on the emergency key as straight as possible away from the vehicle until it releases.
- ▶ Release the door handle.

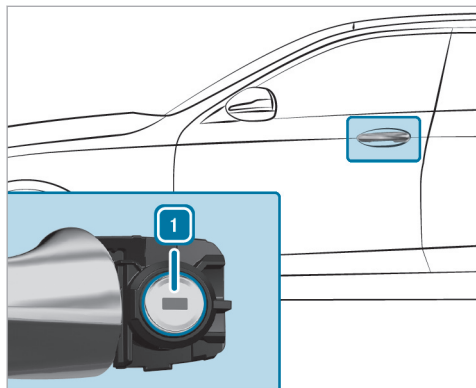

- ▶ **To unlock:** turn the emergency key counter-clockwise to position **1**.
- ▶ **To lock:** turn the emergency key clockwise to position **1**.
- ▶ Carefully press the cover cap onto the lock cylinder until it engages and is seated firmly.

Locking the front passenger door and rear doors

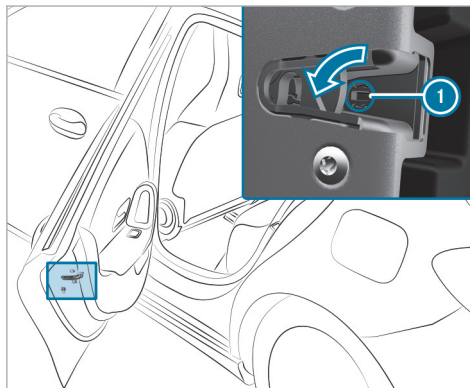

- ▶ Insert a suitable object, e.g. the emergency key, into opening **1** on the door lock.
- ▶ **To lock the left-hand side of the vehicle:** turn the emergency key counter-clockwise as far as it will go.

- ▶ **To lock the right-hand side of the vehicle:** turn the emergency key clockwise as far as it will go.

If the locked door is closed, it can no longer be opened from the outside.

Trunk

Opening the trunk lid

⚠ DANGER Risk of exhaust gas poisoning

Combustion engines emit poisonous exhaust gases such as carbon monoxide. Exhaust gases can enter the vehicle interior if the trunk lid is open when the engine is running, especially if the vehicle is in motion.

- ▶ Always switch off the engine before opening the trunk lid.
- ▶ Never drive with the trunk lid open.

! **NOTE** Damage to the trunk lid by obstacles above the vehicle

The trunk lid swings upwards when it is opened.

► Therefore, make sure that there is sufficient clearance above the trunk lid.

► **Vehicles with HANDS-FREE ACCESS:** Make a kicking movement with your foot below the bumper (→ page 84).

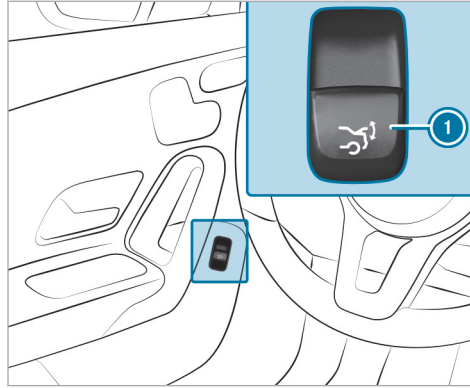

► Pull remote operating switch ① until the trunk lid opens.

or

► Press and hold the  button on the Smart-Key.

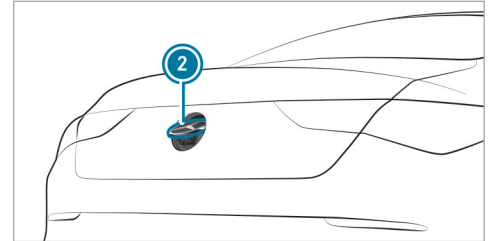

► With the trunk lid unlocked, press the top of the Mercedes star ②.

i To open, pull on the folded-out Mercedes star when the reversing camera is activated.

Closing the trunk lid

! **WARNING** Risk of injury from unsecured items in the vehicle

If objects, luggage or loads are not secured or not secured sufficiently, they could slip, tip over or be thrown around and thereby hit vehicle occupants.

There is a risk of injury, particularly in the event of sudden braking or a sudden change in direction.

- ▶ Always stow objects in such a way that they cannot be thrown around.
- ▶ Before the journey, secure objects, luggage or loads against slipping or tipping over.

Observe the notes on loading the vehicle.

Notes on closing the trunk lid: your vehicle is equipped with automatic key recognition.

Note that the trunk lid will not be locked and will pop back open if the following situation occurs:

- You have locked the vehicle and closed the trunk lid while a key belonging to the vehicle is inside the vehicle and is detected.
- and
- A second key belonging to the vehicle is not detected outside the vehicle.

Automatic key recognition is only an aid and is not a substitute for your attentiveness.

- ▶ Before locking, ensure that at least one key belonging to the vehicle is outside the vehicle.
- ▶ **To close the trunk lid:** pull the trunk lid downwards using the handle recess and push it closed.

HANDS-FREE ACCESS function

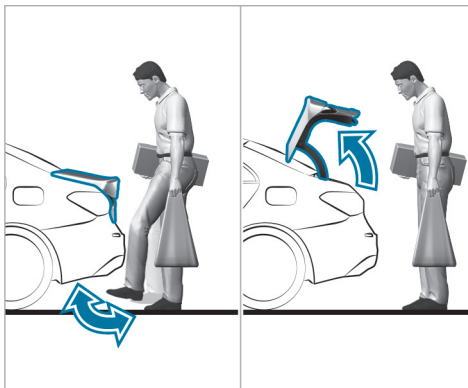

HANDS-FREE ACCESS allows you to open the trunk lid by performing a kicking motion under the bumper. The transmission must be in position **P** for this function.

Observe the notes when opening the trunk lid (→ page 82).

⚠ WARNING Risk of burns caused by a hot exhaust system

The vehicle exhaust system can become very hot. If you use HANDS-FREE ACCESS, you could burn yourself by touching the exhaust system.

- ▶ Always ensure that you only make a kicking movement within the detection range of the sensors.

! **NOTE** Damage to the vehicle caused by unintentionally opening the trunk lid

- When using an automatic car wash
- When using a high pressure cleaner

▶ Deactivate the function of the SmartKey in these situations.

or

▶ Make sure that the SmartKey is at a minimum distance of 10 ft (3 m) away from the vehicle.

Ensure that you are standing firmly on the ground when performing the kicking motion. You could otherwise lose your balance, e.g. on ice.

Observe the following notes:

- If the key is not recognized:
 - Take the key in your hand.
 - or
 - Ensure that the function of the key is activated (→ page 75).
- Stand at least 12 in (30 cm) away from the vehicle when performing the kicking motion.
- Do not come into contact with the bumper when performing the kicking motion.
- Do not carry out the kicking motion too slowly.

- The kicking motion must be towards the vehicle and back again.

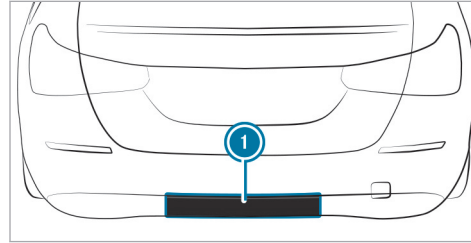

- ① Detection range of the sensors

If several consecutive kicking motions are not successful, wait ten seconds.

System limits

The system may be impaired or inoperative in the following cases:

- The sensors are dirty, e.g. due to road salt or snow.
- The kicking motion is performed with a prosthetic leg.

The trunk lid could be opened unintentionally in the following situations:

- A person's arms or legs are moving in the sensor detection range, e.g. when polishing the vehicle or picking up objects.
- Objects are moved or placed behind the vehicle, e.g. the hose of a fuel dispenser, a charging cable or luggage.
- Tension belts, tarps or other covers are pulled over the bumper.
- A protective mat with a length reaching over the loading sill down into the detection range of the sensors is used.
- The protective mat is not secured correctly.

Deactivate the function of the key (→ page 75) or do not carry the key about your person in such situations.

Unlocking and opening the trunk from inside with the emergency release

Requirements

- The 12 V vehicle battery is connected and charged.

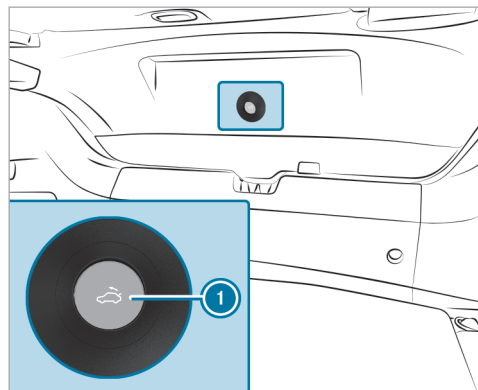

- ▶ Press emergency release button ① briefly.

Activating/deactivating the trunk lid opening height restriction

Multimedia system:

- ▶ ▶ Settings ▶ Vehicle
- ▶▶ Other Functions

- ▶ Switch **Opening Height Limiter** on or off.

This function prevents the trunk lid from hitting a low garage ceiling, for example.

Side windows

Opening and closing the side windows

- ⚠ **WARNING** Risk of entrapment when opening a side window

When opening a side window, parts of the body could be drawn in or become trapped between the side window and window frame.

- ▶ When opening, make sure that nobody is touching the side window.

- ▶ If someone is trapped, release the button immediately or pull it in order to close the side window again.

- ⚠ **WARNING** Risk of becoming trapped when closing a side window

When closing a side window, body parts could be trapped in the closing area in the process.

- ▶ When closing, make sure that no body parts are in the closing area.
- ▶ If someone is trapped, release the button immediately or press the button in order to reopen the side window.

- ⚠ **WARNING** Risk of becoming trapped when children operate the side windows

Children could become trapped if they operate the side windows, particularly when unattended.

- ▶ Activate the child safety lock for the rear passenger compartment side windows.

- ▶ When leaving the vehicle, always take the SmartKey with you and lock the vehicle.
- ▶ Never leave children unattended in the vehicle.

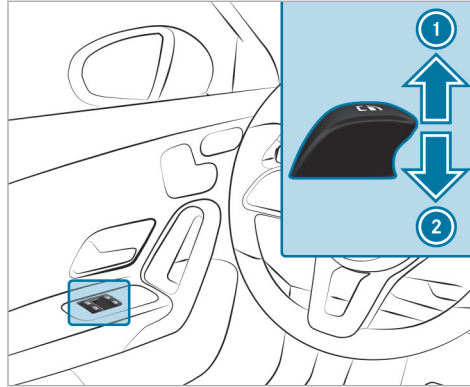

Requirements:

- The power supply of the vehicle has been switched on.



- ① Closing
- ② Opening

The buttons on the driver's door take precedence.

- ▶ **To start automatic operation:** press the  button beyond the pressure point or pull and release it.
- ▶ **To interrupt automatic operation:** press or pull the  button again.

When the vehicle is switched off, you can continue to operate the side windows.

This function is available for around four minutes or until a front door is opened.

Automatic reversing function of the side windows

If an obstacle impedes a side window during the closing process, the side window will open again automatically. The automatic reversing function is only an aid and is not a substitute for your attentiveness.

- ▶ During the closing process, make sure that no body parts are in the closing area.

⚠ WARNING Risk of becoming trapped despite there being reversing protection on the side window

The reversing function does not react:

- To soft, light and thin objects, e.g. fingers.
- During resetting.

The reversing function cannot prevent someone from becoming trapped in these situations.

- ▶ During the closing process, make sure that no body parts are in the closing area.
- ▶ If someone becomes trapped, press the  button to open the side window again.

Convenience opening (ventilating the vehicle before starting a journey)

⚠ WARNING Risk of entrapment when opening a side window

When opening a side window, parts of the body could be drawn in or become trapped between the side window and window frame.

- ▶ When opening, make sure that nobody is touching the side window.
- ▶ Release the button immediately if somebody becomes trapped.

Requirements:

- The key is in immediate proximity to the vehicle.

▶ Press and hold the button  on the key.

The following functions are performed:

- The vehicle is unlocked.
- The side windows are open.
- The panorama roof with power tilt/sliding panel opens.
- The seat ventilation of the driver's seat is switched on.

i If the roller sunblind of the panorama roof with power tilt/sliding panels closed, the roller sunblind is opened first.

▶ **Interrupt convenience opening:** Release the button .

▶ **Continue convenience opening:** Press the button  again and hold pressed.

Convenience closing (closing the vehicle from outside)

⚠ WARNING Risk of entrapment due to not paying attention during convenience closing

When the convenience closing feature is operating, parts of the body could become trapped in the closing area of the side window and the sliding sunroof.

- ▶ When the convenience closing feature is operating, monitor the entire closing process and make sure that no body parts are in the closing area.

Requirements

- The key is near the vehicle.
- ▶ Press and hold the  button on the key. The following functions will be performed:
 - The vehicle will be locked.
 - The side windows will be closed.

- The panoramic sliding sunroof will be closed.

▶ **To interrupt convenience closing:** release the  button.

▶ **To continue convenience closing:** press and hold the  button again.

ⓘ Convenience closing also functions with KEY-LESS-GO (→ page 79).

Resolving problems with the side windows

⚠ WARNING Risk of becoming trapped or fatally injured if reversing protection is not activated

If you close a side window again immediately after it has been blocked, the side window will close with increased or maximum force. The reversing function is then not active and body parts may become trapped.

▶ Make sure that no parts of the body are in the closing area.

▶ To stop the closing process, release the button or press the button again to reopen the side window.

A side window cannot be closed and you cannot see the cause.

- ▶ Check to see whether any objects are in the window guide.
- ▶ Adjust the side windows.

Adjusting the side windows

If a side window is obstructed during closing and reopens again immediately:

- ▶ Immediately after this, pull and hold the corresponding button again until the side window has closed and hold the button for at least one more second (re-adjustment). The side window will be closed without the automatic reversing function.

If the side window is obstructed again and reopens again immediately:

- ▶ Immediately after this, pull and hold the corresponding button again until the side window

has closed and hold the button for at least one more second (follow-up adjustment). The side window will be closed without the automatic reversing function.

- ▶ If a side window is obstructed again during closing and reopens again slightly, consult a qualified specialist workshop.

The side windows cannot be opened or closed using the convenience opening feature.

Possible causes:

- The key is not in the immediate vicinity of the vehicle.
- The key battery is weak or discharged.
- ▶ Check the battery using the indicator lamp (→ page 74).
- ▶ Replace the key battery, if necessary (→ page 76).

Sliding sunroof

Opening and closing the sliding sunroof

i The term "sliding sunroof" also refers to the panoramic sliding sunroof.

⚠ WARNING Risk of becoming trapped when the sliding sunroof is being opened and closed

Body parts may become trapped in the range of movement.

- ▶ During opening and closing, make sure that no body parts are in the range of movement.
- ▶ Release the button immediately if somebody becomes trapped.

or

- ▶ Briefly press the button in any direction during automatic operation. The opening or closing process will be stopped.

⚠ WARNING Risk of becoming trapped if the sliding sunroof is operated by children

Children operating the sliding sunroof could get caught in the moving parts, particularly if unattended.

- ▶ Never leave children unattended in the vehicle.
- ▶ When leaving the vehicle, always take the key with you and lock the vehicle.

⚠ WARNING Risk of becoming trapped when the roller sunblind is being opened and closed

Body parts may become trapped between the roller sunblind and frame or sliding roof.

- ▶ When opening or closing, make sure that no body parts are in the roller sunblind's range of movement.
- ▶ Release the button immediately if somebody becomes trapped.

or

- ▶ Briefly press the button in any direction during automatic operation. The opening or closing process will be stopped.

! NOTE Malfunction due to snow and ice

Snow and ice may cause the sliding sunroof to malfunction.

- ▶ Open the sliding sunroof only if it is free of snow and ice.

! NOTE Damage caused by moisture ingress

- ▶ Do not open the sliding sunroof if it has just rained.
- ▶ Do not open the sliding sunroof immediately after washing the vehicle in a car wash.

! NOTE Damage caused by protruding objects

Objects that protrude from the sliding sunroof may damage the seals.

- ▶ Do not allow anything to protrude from the sliding sunroof.

! **NOTE** Damage to the panorama roof with power tilt/sliding panel due to non-approved roof luggage racks

The panorama roof with power tilt/sliding panel may be damaged by the roof luggage rack if you attempt to open it when using a roof luggage rack not tested and approved for Mercedes-Benz.

- ▶ When a roof luggage rack is installed, open the panorama roof with power tilt/sliding panel only if this has been tested and approved for Mercedes-Benz.

The panorama roof with power tilt/sliding panel may be raised to allow ventilation of the vehicle interior.

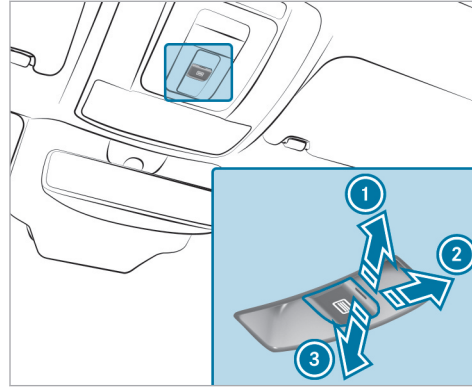



- ① To raise
- ② To open
- ③ To close/lower

Use the  button to operate the panoramic sliding sunroof and the roller sunblind.

The panoramic sliding sunroof can be operated only when the roller sunblind is open.

- ▶ Check whether the sliding sunroof can be raised or opened when a roof luggage rack is installed.

▶ **To start automatic operation:** press the  button beyond the point of resistance or pull and release it.

▶ **To interrupt automatic operation:** briefly press the  button in any direction. The opening/closing process will be stopped.

Vehicles with a panoramic sliding sunroof: the automatic raising feature is available only when the sliding sunroof is closed or raised.

Automatic reversing function of the sliding sunroof

If an obstacle obstructs the sliding sunroof during the closing process, the sliding sunroof will open again automatically. The automatic reversing function serves solely as an aid and is not a substitute for your attentiveness.

- ▶ Keep the opening area and the guide rails free of deposits, e.g. ice, snow or leaves.

▶ When closing the sliding sunroof, make sure that no body parts or objects are in the closing area.

⚠ WARNING Risk of becoming trapped despite the reversing function being active

In particular, the reversing function does not react:

- To soft, light and thin objects, e.g. fingers.
- Towards the end of the closing procedure.
- During resetting.

▶ During the closing process, make sure that no body parts are in the closing area.

▶ Release the button immediately if somebody becomes trapped.

or

▶ Briefly press the button in any direction during automatic operation.
The closing process will be stopped.

Automatic reversing function of the roller sunblind

If an obstacle obstructs the roller sunblind during the closing process, the roller sunblind will open again automatically. The automatic reversing function serves solely as an aid and is not a substitute for your attentiveness.

▶ Keep the opening area and the guide rails free of deposits, e.g. ice, snow or leaves.

▶ When closing the roller sunblind, make sure that no body parts or objects are in the area of movement.

⚠ WARNING Risk of becoming trapped despite reversing function

In particular, the reversing function does not react to soft, light and thin objects, e.g. fingers.

▶ When closing the roller sunblind, make sure that no body parts are in the range of movement.

▶ Release the button immediately if somebody becomes trapped.

or

▶ Briefly press the button in any direction during the automatic closing process.
The closing process will be stopped.

Automatic functions of the sliding sunroof

i The term "sliding sunroof" also refers to the panoramic sliding sunroof.

Rain closing function when driving

Vehicles with a panoramic sliding sunroof: if it starts to rain, the raised sliding sunroof will automatically be lowered while the vehicle is in motion.

Automatic lowering function

Vehicles with a panoramic sliding sunroof: if the sliding sunroof is raised at the rear, it will automatically be lowered slightly at higher speeds. At low speeds, it will be raised again automatically.

⚠ WARNING Risk of becoming trapped by automatic lowering of the sliding sunroof

At higher speeds, the raised sliding sunroof will automatically be lowered slightly at the rear.

- ▶ Make sure that nobody reaches into the sliding sunroof's range of movement while the vehicle is in motion.
- ▶ If somebody becomes trapped, briefly push the sliding sunroof button forwards or backwards.

i By pushing or pulling the  button, you can interrupt the automatic functions "Rain closing function when driving" and "Automatic lowering".

Rectifying problems with the sliding sunroof

⚠ WARNING Risk of becoming trapped or fatal injuries when the sliding sunroof is closed again

If the sliding sunroof is closed again immediately after it has been blocked or reset, it will close with increased force.

- ▶ Make sure that no parts of the body are in the closing area.
- ▶ Release the button immediately if somebody becomes trapped.

or

- ▶ Briefly press the button in any direction during the automatic closing process. The closing process will be stopped.

The sliding sunroof cannot be closed and you cannot see the cause.

i The term "sliding sunroof" also refers to the panorama roof with power tilt/sliding panel.

If the sliding sunroof is obstructed during closing and reopens again slightly:

- ▶ Immediately after automatic reversing, pull and hold the  button down again to the point of resistance until the sliding sunroof is closed. The sliding sunroof will be closed with increased force.



If the sliding sunroof is obstructed again and opens again slightly:

- ▶ Repeat the previous step. The sliding sunroof will be closed again with increased force.

Vehicles with a panorama roof with power tilt/sliding panel: The sliding sunroof or the roller sunblind is not operating smoothly.

- ▶ Reset the sliding sunroof and the roller sunblind.

Resetting the sliding sunroof and the roller sunblind

- ▶ Pull and hold the  button little by little until the sliding sunroof is fully closed.
- ▶ Pull and hold the  button little by little until the roller sunblind is fully closed.

- ▶ Use automatic operation to fully open and then close the sliding sunroof.

Anti-theft protection

Function of the immobilizer

The immobilizer prevents your vehicle from being started without the correct key.

The immobilizer is automatically activated when the vehicle is switched off, and deactivated when the vehicle is switched on.

When leaving the vehicle, always take the key with you and lock the vehicle. Anyone can start the vehicle if a valid key has been left inside the vehicle.

- ❗ In the event that the engine cannot be started (although the vehicle's starter battery is charged), the immobilizer may be defective. Contact an authorized Mercedes-Benz Center or call 1-800-FOR-MERCEdes (in the USA) or 1-800-387-0100 (in Canada).

ATA (anti-theft alarm system)

Function of the ATA system

If the ATA system is armed, a visual and audible alarm will be triggered in the following situations:

- When a door is opened
- When the trunk lid is opened
- When the hood is opened
- When the interior protection is triggered (→ page 95)
- When the tow-away alarm is triggered (→ page 95)

The ATA system will be armed automatically after approximately ten seconds in the following situations:

- After you lock the vehicle with the key
- After you lock the vehicle using KEYLESS-GO

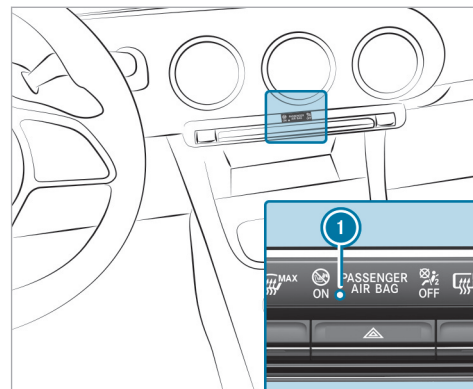

Indicator lamp ❶ will flash when the ATA system is armed.

The ATA system will be disarmed automatically in the following situations:

- After you unlock the vehicle with the key
- After you unlock the vehicle using KEYLESS-GO

- After you press the Start/Stop button with the key in the marked space (→ page 143)
- i** If the battery is heavily discharged, the Anti-Theft Alarm system is automatically deactivated to facilitate the next engine start.

Deactivating the ATA

- ▶ Press the ,  or  button on the key.

or

- ▶ Press the start/stop button with the key in the stowage compartment (→ page 143)

Deactivating the alarm using KEYLESS-GO

- ▶ Grasp the outside door handle with the key outside the vehicle.

Function of tow-away alarm

- i** This function may not be available in all countries.

A visual and audible alarm will be triggered if an alteration to your vehicle's angle of inclination is detected while the tow-away alarm is armed.



The tow-away alarm will be armed automatically after about 60 seconds:

- After you lock the vehicle with the key
- After you lock the vehicle using KEYLESS-GO

The tow-away alarm will be armed only when the following components are closed:

- Doors
- Trunk lid

The tow-away alarm will automatically be deactivated:

- After you press the  or  button on the key
- After you press the start/stop button with the key in the marked space (→ page 143)
- After you unlock the vehicle using KEYLESS-GO
- When using HANDS-FREE ACCESS

Information on collision detection on a parked vehicle (→ page 170).

Arming/deactivating tow-away alarm

Multimedia system:

- ▶  ▶ Settings ▶ Vehicle
- ▶ Opening/closing ▶ Vehicle Protection

- ▶ Arm or deactivate **Tow-away Protection**.

Tow-away alarm is armed again in the following cases:

- The vehicle is unlocked again.
- A door is opened.
- The vehicle is locked again.

Function of interior protection

- i** This function may not be available in all countries.

When interior protection is armed, a visual and audible alarm is triggered if movement is detected in the vehicle interior.

Interior protection is armed automatically after approximately ten seconds:



- after locking the vehicle with the key

- after locking the vehicle using KEYLESS-GO

Interior protection is armed only when the following components are closed:

- Doors
- Trunk lid

Interior protection is automatically deactivated:

- after pressing the  or  button on the key
- after pressing the start/stop button with the key in the stowage compartment (→ page 143)
- after unlocking the vehicle using KEYLESS-GO
- when using HANDS-FREE ACCESS

The following situations can lead to a false alarm:

- when there are moving objects such as mascots in the vehicle interior
- if a side window is open
- if the panorama roof with power tilt/sliding panel is open

Arming/disarming interior protection

Multimedia system:

-  ➤ Settings ➤ Vehicle
- Opening/closing ➤➤ Vehicle Protection
- ▶ Activate or deactivate [Interior Protection](#).

Interior protection will be armed again in the following cases:

- The vehicle is unlocked again.
- A door is opened.
- The vehicle is locked again.

Notes on the correct driver's seat position

⚠ WARNING Risk of accident due to adjusting the vehicle settings while the vehicle is in motion

You could lose control of the vehicle in the following situations in particular:

- If you adjust the driver's seat, the head restraint, the steering wheel or the mirror while the vehicle is in motion
- If you fasten your seat belt while the vehicle is in motion

▶ Before starting the vehicle: in particular, adjust the driver's seat, head restraint, steering wheel and mirror, and fasten your seat belt.

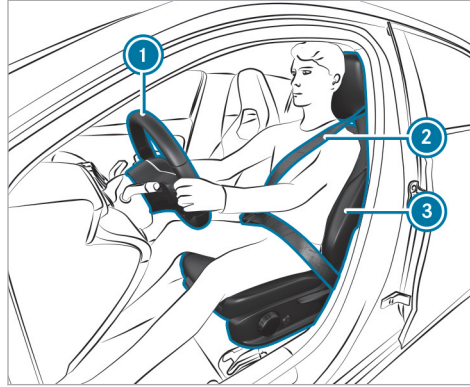

Ensure the following when adjusting steering wheel ①, seat belt ② and driver's seat ③:

- You are sitting as far away from the driver's air bag as possible, taking the following points into consideration:
- You are sitting in an upright position
- Your thighs are slightly supported by the seat cushion

- Your legs are not fully extended and you can depress the pedals properly
- The back of your head is supported at eye level by the center of the head restraint
- You can hold the steering wheel with your arms slightly bent
- You can move your legs freely
- You can see all the displays on the driver display clearly
- You have a good overview of the traffic conditions
- Observe the notes on correctly fastening the seat belt (→ page 43).

Vehicles with an AMG Performance seat: if the front passenger seat is unoccupied, this can lead to noise caused by the seat belt tongue knocking against the seat. You can prevent this by sliding the seat belt tongue upwards with the seat belt adjuster clip. If the front passenger seat is occupied, ensure that the seat belt adjuster clip is pushed down. Only then will the seat belt fit snugly against the body.

Notes on grab handles

⚠ WARNING Risk of injury due to excessive load on the grab handles

If you apply your full body weight to the grab handle or pull it abruptly, the grab handle may be damaged or come loose from its anchorage. This may result in injuries.

- ▶ Use the grab handles only to stabilize the seating position or to assist in getting in and out of the seat.

Seats

Adjusting the front seat manually (without Seat Comfort Package)

⚠ WARNING Risk of becoming trapped if the seats are adjusted by children

Children could become trapped if they adjust the seats, particularly when unattended.

- ▶ When leaving the vehicle, always take the SmartKey with you and lock the vehicle.
- ▶ Never leave children unattended in the vehicle.

⚠ WARNING Risk of becoming trapped when adjusting the seat

When you adjust a seat, you or other vehicle occupants could become trapped, e.g. on the seat guide rail.

- ▶ When adjusting a seat, make sure that no one has any part of their body within the sweep of the seat.

Observe the safety notes on "Air bags" and "Children in the vehicle".

⚠ WARNING Risk of accident due to the driver's seat not being engaged

The driver's seat may move unexpectedly while driving.

This could cause you to lose control of the vehicle.

- ▶ Always make sure that the driver's seat is engaged before starting the vehicle.

⚠ WARNING Risk of accident due to adjusting the vehicle settings while the vehicle is in motion

You could lose control of the vehicle in the following situations in particular:

- If you adjust the driver's seat, the head restraint, the steering wheel or the mirror while the vehicle is in motion
- If you fasten your seat belt while the vehicle is in motion

- ▶ Before starting the vehicle: in particular, adjust the driver's seat, head restraint, steering wheel and mirror, and fasten your seat belt.

⚠ WARNING Risk of becoming trapped if the seat height is adjusted carelessly

If you adjust the seat height carelessly, you or other vehicle occupants could be trapped and thereby injured.

Children in particular could accidentally press the electrical seat adjustment buttons and become trapped.

- ▶ While moving the seats, make sure that hands or other body parts do not get under the lever assembly of the seat adjustment system.

⚠ WARNING Risk of injury due to head restraints not being installed or being adjusted incorrectly

If head restraints have not been installed or have not been adjusted correctly, there is an increased risk of injury in the head and neck area, e.g. in the event of an accident or when braking.

- ▶ Always drive with the head restraints installed.
- ▶ Before driving off, make sure for every vehicle occupant that the center of the head restraint supports the back of the head at about eye level.

Do not interchange the head restraints of the front and rear seats. Otherwise, you will not be able to adjust the height and angle of the head restraints correctly.

Adjust the head restraint fore-and-aft position so that it is as close as possible to the back of your head.

⚠ WARNING Risk of injury or death due to an incorrect seat position

The seat belt does not offer the intended level of protection if you have not moved the seat backrest to an almost vertical position.

In particular, you could slip beneath the seat-belt and become injured.

- ▶ Adjust the seat properly before beginning your journey.
- ▶ Always ensure that the seat backrest is in an almost vertical position and that the shoulder belt is routed across the center of your shoulder.

⚠ WARNING Risk of injury due to excessive load on the grab handles

If you apply your full body weight to the grab handle or pull it abruptly, the grab handle may be damaged or come loose from its anchorage. This may result in injuries.

- ▶ Use the grab handles only to stabilize the seating position or to assist in getting in and out of the seat.

⚠ WARNING Risk of potentially fatal injuries due to objects trapped under the front passenger seat

Objects trapped under the front passenger seat may interfere with the function of the

automatic front passenger air bag shutoff or damage the system.

- ▶ Do not stow any objects under the front passenger seat.
- ▶ When the front passenger seat is occupied, ensure that no objects have become trapped beneath the front passenger seat.

Adjusting the seat fore-and-aft position

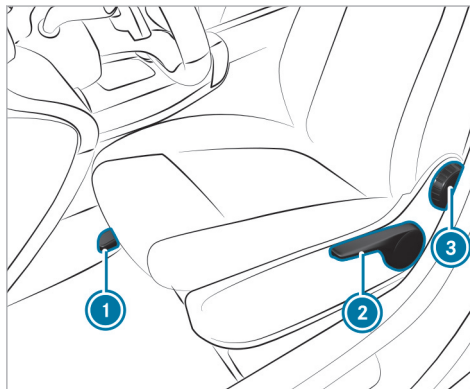

- ▶ Lift lever ① and slide the seat into the desired position.
- ▶ Make sure that the seat is engaged.
- ▶ **To adjust the seat height:** push or pull lever ② until the desired position has been reached.

- ▶ **To adjust the seat backrest inclination:** turn handwheel ③ forwards and backwards until the desired position has been reached.

Adjusting the front seat mechanically (with Seat Comfort Package)

⚠ WARNING Risk of becoming trapped if the seats are adjusted by children

Children could become trapped if they adjust the seats, particularly when unattended.

- ▶ When leaving the vehicle, always take the SmartKey with you and lock the vehicle.
- ▶ Never leave children unattended in the vehicle.

This also applies to the Digital Vehicle Key.

⚠ WARNING Risk of becoming trapped when adjusting the seat

When you adjust a seat, you or other vehicle occupants could become trapped, e.g. on the seat guide rail.

- ▶ When adjusting a seat, make sure that no one has any part of their body within the sweep of the seat.

Observe the safety notes on "Airbags" and "Children in the vehicle".

- ⚠ WARNING** Risk of accident due to the driver's seat not being engaged

The driver's seat may move unexpectedly while driving.

This could cause you to lose control of the vehicle.

- ▶ Always make sure that the driver's seat is engaged before starting the vehicle.

- ⚠ WARNING** Risk of accident due to adjusting the vehicle settings while the vehicle is in motion

You could lose control of the vehicle in the following situations in particular:

- If you adjust the driver's seat, the head restraint, the steering wheel or the mirror while the vehicle is in motion
- If you fasten your seat belt while the vehicle is in motion
- ▶ Before starting the vehicle: in particular, adjust the driver's seat, head restraint, steering wheel and mirror, and fasten your seat belt.

- ⚠ WARNING** Risk of becoming trapped if the seat height is adjusted carelessly

If you adjust the seat height carelessly, you or other vehicle occupants could be trapped and thereby injured.

Children in particular could accidentally press the electrical seat adjustment buttons and become trapped.

- ▶ While moving the seats, make sure that hands or other body parts do not get under the lever assembly of the seat adjustment system.

- ⚠ WARNING** Risk of injury due to head restraints not being installed or being adjusted incorrectly

If head restraints have not been installed or have not been adjusted correctly, there is an increased risk of injury in the head and neck area, e.g. in the event of an accident or when braking.

- ▶ Always drive with the head restraints installed.
- ▶ Before driving off, make sure for every vehicle occupant that the center of the head restraint supports the back of the head at about eye level.

Do not interchange the head restraints of the front and rear seats. Otherwise, you will not be able to adjust the height and angle of the head restraints correctly.

Adjust the head restraint fore-and-aft position so that it is as close as possible to the back of your head.

⚠ WARNING Risk of injury or death due to an incorrect seat position

The seat belt does not offer the intended level of protection if you have not moved the seat backrest to an almost vertical position.

In particular, you could slip beneath the seat-belt and become injured.

- ▶ Adjust the seat properly before beginning your journey.
- ▶ Always ensure that the seat backrest is in an almost vertical position and that the shoulder belt is routed across the center of your shoulder.

⚠ WARNING Risk of injury due to excessive load on the grab handles

If you apply your full body weight to the grab handle or pull it abruptly, the grab handle may be damaged or come loose from its anchorage. This may result in injuries.

- ▶ Use the grab handles only to stabilize the seating position or to assist in getting in and out of the seat.

⚠ WARNING Risk of potentially fatal injuries due to objects trapped under the front passenger seat

Objects trapped under the front passenger seat may interfere with the function of the automatic front passenger air bag shutoff or damage the system.

- ▶ Do not stow any objects under the front passenger seat.
- ▶ When the front passenger seat is occupied, ensure that no objects have become trapped beneath the front passenger seat.

Adjusting the seat fore-and-aft position

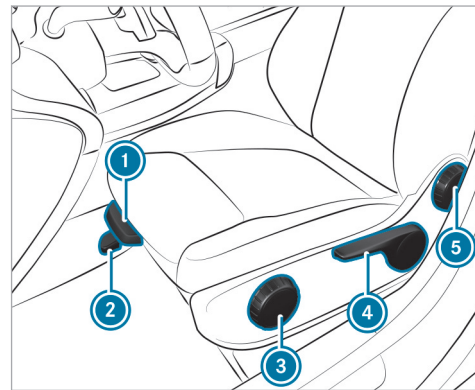

- ▶ Lift lever ② and slide the seat into the desired position.
- ▶ Make sure that the seat is engaged.
- ▶ **To adjust the seat cushion length (driver's seat only):** lift lever ① and slide the front section of the seat cushion forwards or backwards.

- ▶ **To adjust the seat cushion inclination:** turn handwheel ③ forwards and backwards until the desired position has been reached.
- ▶ **To adjust the seat height:** push or pull lever ④ until the desired position has been reached.
- ▶ **To adjust the seat backrest inclination:** turn handwheel ⑤ forwards and backwards until the desired position has been reached.

Adjusting the front seat electrically

You can adjust the seats when the vehicle is switched off.

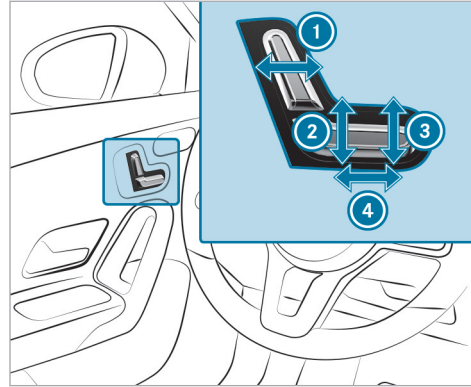

- ① Seat backrest inclination
- ② Seat height
- ③ Seat cushion inclination
- ④ Seat fore-and-aft position

- ▶ Save the settings with the memory function (→ page 111).

Adjusting the 4-way lumbar support

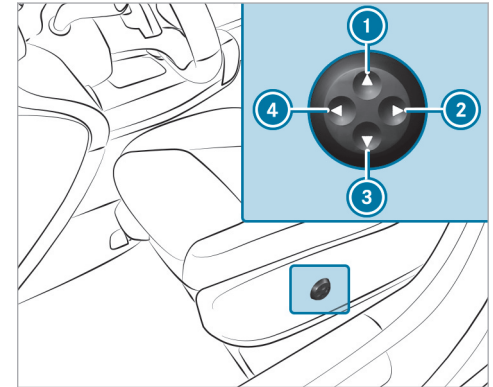

- ① Higher
- ② Softer
- ③ Lower
- ④ Firmer

- ▶ Use buttons ① to ④ to adjust the contour of the backrest.

Head restraints

Adjusting the front seat head restraints manually

⚠ WARNING Risk of accident due to adjusting the vehicle settings while the vehicle is in motion

You could lose control of the vehicle in the following situations in particular:

- If you adjust the driver's seat, the head restraint, the steering wheel or the mirror while the vehicle is in motion
 - If you fasten your seat belt while the vehicle is in motion
- ▶ Before starting the vehicle: in particular, adjust the driver's seat, head restraint, steering wheel and mirror, and fasten your seat belt.

⚠ WARNING Risk of injury due to head restraints not being installed or being adjusted incorrectly

If head restraints have not been installed or have not been adjusted correctly, there is an increased risk of injury in the head and neck area, e.g. in the event of an accident or when braking.

- ▶ Always drive with the head restraints installed.
- ▶ Before driving off, make sure for every vehicle occupant that the center of the head restraint supports the back of the head at about eye level.

Do not interchange the head restraints of the front and rear seats. Otherwise, you will not be able to adjust the height and angle of the head restraints correctly.

Adjust the head restraint fore-and-aft position so that it is as close as possible to the back of your head.

For vehicles with sports seats, it is not possible to adjust the front head restraints.

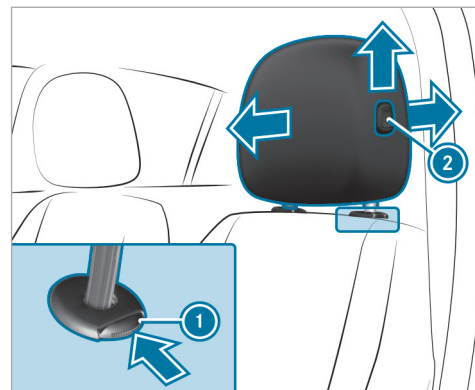

- ▶ **To raise:** pull the head restraint up.
- ▶ **To lower:** press release knob ① in the direction of the arrow and push the head restraint down.
- ▶ **To move forwards:** press release knob ② and pull the head restraint forwards.
- ▶ **To move backwards:** press release knob ② and push the head restraint backwards.

Adjusting the head restraints of the rear seats manually

In vehicles with sports seats, it is not possible to adjust the outer head restraints.

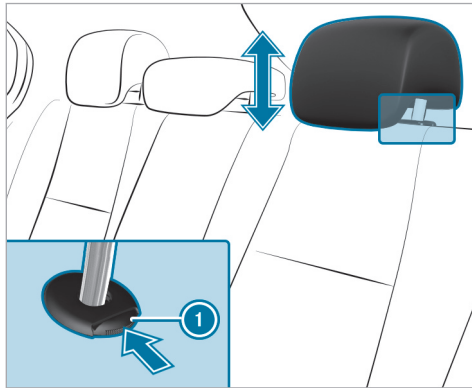

- ▶ **To raise:** pull the head restraint up.
- ▶ **To lower:** press release knob ① and push the head restraint down.

Installing/removing the rear seat head restraints

Removing

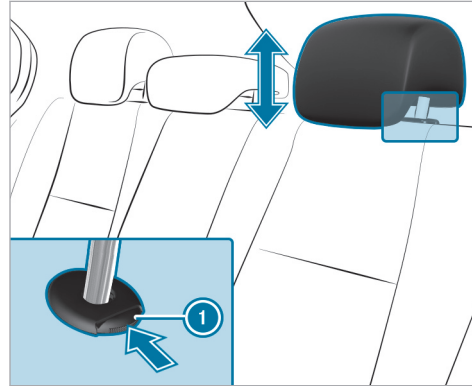

- ▶ Release the rear seat backrest and fold it forwards slightly (→ page 116).
- ▶ Pull the head restraint upwards as far as it will go.

- ▶ Push release knob ① in the direction of the arrow and pull out the head restraint.

Installing

- ▶ Insert the head restraint such that the notches on the bar are on the left when viewed in the direction of travel.
- ▶ Push the head restraint down until it engages.
- ▶ Fold the rear seat backrest back until it engages.

Setting automatic seat adjustment

⚠ WARNING Risk of becoming trapped during adjustment of the driver's seat after calling up a driver profile

Selecting a user profile may trigger an adjustment of the driver's seat to the position saved under the user profile. You or other vehicle occupants could be injured in the process.

- ▶ Make sure that when the position of driver's seat is being adjusted using the mul-

multimedia system, no people or body parts are in the seat's range of movement.

If there is a risk of someone becoming trapped, immediately stop the adjustment process by:

▶ a) Pressing the warning message on the central display.

or

▶ b) Pressing a position button of the memory function or a seat adjustment switch in the driver's door.
The adjustment process is stopped.

Multimedia system:

→  ▶▶ Comfort ▶▶ Seat
▶▶ Automatic Seat Positioning

Manually adjusting driver's seat and steering wheel position to body size

The vehicle will calculate suitable driver's seat and steering wheel positions on the basis of the driver's body size and set them directly.

▶ **To set the unit of measurement:** select **cm** or **ft/in**.

▶ Set the size using the scale.

▶ Select **Start Positioning**.

The driver's seat and steering wheel positions will be adjusted to the body size that has been set.

ⓘ You can also configure these settings via the Mercedes me user account for your user profile. By synchronising the profiles in the vehicle and the Mercedes me connect profiles, you can carry over these settings for your vehicle.

ⓘ If the driver's seat and steering wheel positions calculated by the vehicle are not practical or comfortable, they can be manually adapted at any time via the control buttons. The outside mirrors are not set via this function. Instead, they have to be set manually via the operating switches.

Resetting seat settings

Multimedia system:

→  ▶▶ Comfort ▶▶ Seat

▶ Select **Reset**.

▶ Select  for the desired seat.
The settings for the selected seat will be reset.

Switching the seat heating on/off

⚠ WARNING Risk of burns due to repeatedly switching on the seat heating

Repeatedly switching on the seat heating can cause the seat cushion and seat backrest padding to become very hot.

In particular, the health of persons with limited temperature sensitivity or a limited ability to react to high temperatures may be affected or they may even suffer burn-like injuries.

▶ Do not repeatedly switch on the seat heating.

To protect against overheating, the seat heating may be temporarily deactivated after it has been switched on repeatedly.

! **NOTE** Damage to the seats caused by objects or documents when the seat heating is switched on

When the seat heating is switched on, overheating may occur due to objects or documents placed on the seats, e.g. seat cushions or child seats. This could cause damage to the seat surface.

▶ Make sure that no objects or documents are on the seats when the seat heating is switched on.

Requirements

- The power supply is switched on.

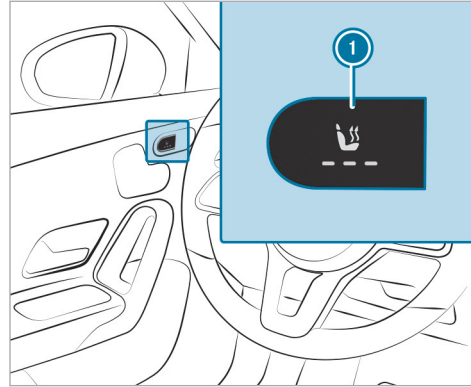

- ▶ Press button ① repeatedly until the desired heating level is set. Depending on the heating level, up to three indicator lamps will light up. If all indicator lamps are off, the seat heating is switched off.
- ① The seat heating will automatically switch down from the three heating levels after 8, 10 and 20 minutes until the seat heating switches off.

Switching the seat ventilation on/off

Requirements

- The power supply is switched on.

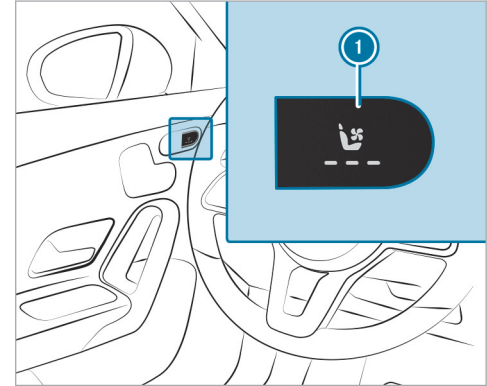

- ▶ Press button ① repeatedly until the desired blower setting has been reached. Depending on the blower setting, up to three indicator lamps will light up. If all indicator

lamps are off, the seat ventilation is switched off.

Steering wheel

Adjusting the steering wheel manually

⚠ WARNING Risk of accident due to adjusting the vehicle settings while the vehicle is in motion

You could lose control of the vehicle in the following situations in particular:

- If you adjust the driver's seat, the head restraint, the steering wheel or the mirror while the vehicle is in motion
 - If you fasten your seat belt while the vehicle is in motion
- ▶ Before starting the vehicle: in particular, adjust the driver's seat, head restraint, steering wheel and mirror, and fasten your seat belt.

⚠ WARNING Risk of entrapment for children when adjusting the steering wheel

Children could injure themselves if they adjust the steering wheel.

- ▶ Never leave children unattended in the vehicle.
- ▶ When leaving the vehicle, always take the key with you and lock the vehicle.

Unlocking

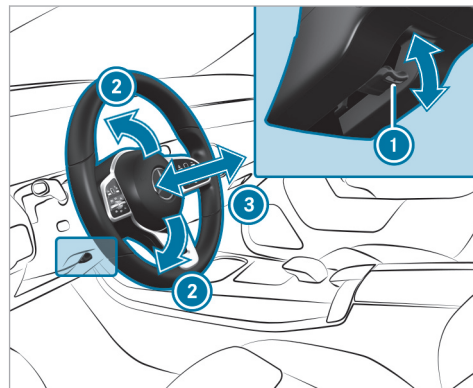

- ▶ Fold release lever ① down as far as it will go.
- ▶ Adjust height ② and distance ③ to the steering wheel.

Locking

- ▶ Fold release lever ① up as far as it will go.

- ▶ Check and make sure that the steering column is locked by moving the steering wheel.

Switching the steering wheel heater on/off

Depending on the vehicle version, the steering wheel heater can be switched on/off via a switch on the steering wheel.

Requirements

- The vehicle is switched on.

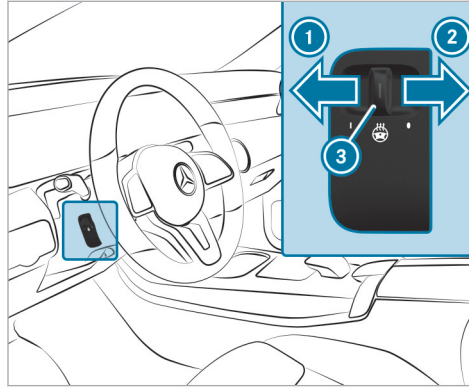

- ▶ **To switch on:** push the switch to position ①. If the indicator lamp ③ lights up, the steering wheel heater is switched on.
- ▶ **To switch off:** push the switch to position ②.

When you switch the vehicle off, the steering wheel heater will switch off.

Easy entry and exit feature

Using the easy entry and exit feature

- ⚠ **WARNING** Risk of accident when pulling away during the adjustment process of the easy entry and exit feature

You could lose control of the vehicle.

- ▶ Always wait until the adjustment process is complete before driving off.

- ⚠ **WARNING** Risk of becoming trapped during adjustment of the easy entry and exit feature

You and other vehicle occupants could become trapped.

- ▶ Ensure that no-one has any body parts in the range of movement of the seat.

If there is a risk of becoming trapped by the driver's seat:

- ▶ Press the seat adjustment switch. The adjustment process will be stopped.

You can stop the adjustment process by pressing one of the memory function position switches.

⚠ WARNING Risk of becoming trapped if children activate the easy entry and exit feature

Children could become trapped if they activate the easy entry and exit feature, particularly when unattended.

- ▶ Never leave children unattended in the vehicle.
- ▶ When leaving the vehicle, always take the key with you and lock the vehicle.

If the easy entry and exit feature is active, the driver's seat will move into an ideal position for entering or exiting the vehicle and the seat backrest will adjust to a more upright position in the following situations:

- You switch off the vehicle when the driver's door is open.
- You open the driver's door when the vehicle is switched off.

- ⓘ The driver's seat only moves forwards or backwards if it is not already in an ideal position for entering or exiting the vehicle. The seat backrest will then move forwards only if it is not already at the front of the backrest adjustment range.

The driver's seat will move back to the last drive position when:

- You switch the vehicle on when the driver's door is closed.
- You close the driver's door when the vehicle is switched on.

The last drive position will be saved when:

- If you switch off the vehicle.
- You call up the seat settings via the memory function.
- You save the seat settings via the memory function.

Setting the easy entry and exit feature

Requirements:

- The automatic seat adjustment has been activated (→ page 105).
- The power supply or the vehicle has been switched on.

Multimedia system:

➔  ➔ Settings ➔ Vehicle ➔ Comfort
➔ Easy Entry And Exit Feature

Setting the easy entry and exit feature

▶ Select **Steering Wheel & Seat, Steering Wheel Only** or **Off**.

- ⓘ If you are using a custom user profile, this information will be used for the easy entry and exit feature. This will cause the driver's seat and steering wheel to move into the correct position automatically (→ page 243).

Memory function

Memory function

- ⚠ WARNING** Risk of an accident if the memory function is used while driving

If you use the memory function on the driver's side while driving, you could lose control of the vehicle as a result of the adjustments being made.

- ▶ Only use the memory function on the driver's side when the vehicle is stationary.

- ⚠ WARNING** Risk of entrapment when adjusting the seat with the memory function

When the memory function adjusts the seat or steering wheel, you and other vehicle occupants – particularly children – could become trapped.

- ▶ During the adjusting process of the memory function, ensure that no body

parts are in the sweep of the seat or the steering wheel.

- ▶ If somebody becomes trapped, immediately release the memory function position button. The adjustment process is stopped.

- ⚠ WARNING** Danger of entrapment when memory function is activated by children

When children activate the memory function, they can get trapped, especially if they are unsupervised.

- ▶ Never leave children unattended in the vehicle.
- ▶ When leaving the vehicle, always take the key with you and lock the vehicle.

You can use the memory function when the vehicle is switched off.

Seat adjustments for up to three people can be stored and called up using the memory function.

You can save settings for the following systems:

- Seat, backrest and head restraint

- Outside mirrors

Operating the memory function

Storing

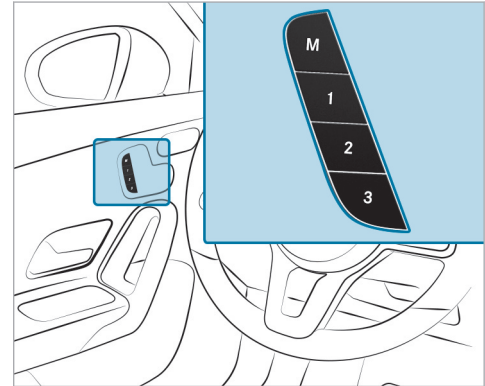

- ▶ Set the desired position for all systems.

- ▶ Briefly press memory button **M** and then press preset position **1**, **2** or **3** within three seconds.

An acoustic signal sounds. The settings are stored.

- ▶ **To call up:** press and briefly hold one of preset position buttons **1**, **2** or **3**. After releasing the button, all systems are moved into the stored position.

Stowage areas

Notes on loading the vehicle

⚠ DANGER Risk of exhaust gas poisoning

Combustion engines emit poisonous exhaust gases such as carbon monoxide. Exhaust gases can enter the vehicle interior if the trunk lid is open when the engine is running, especially if the vehicle is in motion.

- ▶ Always switch off the engine before opening the trunk lid.
- ▶ Never drive with the trunk lid open.

Objects in the deployment area of an air bag may prevent the air bag from functioning correctly. Observe the notes on air bags in this regard (→ page 57).

⚠ WARNING Risk of injury from unsecured items in the vehicle

If objects, luggage or loads are not secured or not secured sufficiently, they could slip, tip over or be thrown around and thereby hit vehicle occupants.

There is a risk of injury, particularly in the event of sudden braking or a sudden change in direction.

- ▶ Always stow objects in such a way that they cannot be thrown around.
- ▶ Before the journey, secure objects, luggage or loads against slipping or tipping over.

⚠ WARNING Risk of injury due to objects being stowed incorrectly

If objects in the vehicle interior are stowed incorrectly, they can slide or be thrown around and hit vehicle occupants. In addition, cup holders, open storage spaces and mobile phone brackets cannot always retain all objects they contain.

There is a risk of injury, particularly in the event of sudden braking or a sudden change in direction.

- ▶ Always stow objects in such a way that they cannot be thrown around in such situations.
- ▶ Always make sure that objects do not protrude from storage spaces, parcel nets or storage nets.
- ▶ Close the lockable storage spaces before starting a journey.
- ▶ Always stow and secure heavy, hard, pointed, sharp-edged, fragile or bulky objects in the trunk.

⚠ WARNING Risk of accident due to objects in the driver's and front-passenger footwell

Objects in the driver's and front-passenger footwell may impede pedal travel or block a depressed pedal.

This jeopardizes the operating- and road safety of the vehicle.

- ▶ Stow all objects in the vehicle securely so that they cannot get into the driver's or front-passenger footwell.
- ▶ Always ensure that the pedals have sufficient free space.
- ▶ Always install the floor mats securely and as prescribed.
- ▶ Do not use loose floor mats and do not place floor mats on top of one another.

Vehicles with automatic front passenger air bag deactivation: objects trapped under the front passenger seat may interfere with the function of the automatic front passenger air bag deactivation or damage the system. Therefore please

observe the notes on the function of automatic front passenger air bag deactivation (→ page 48).

⚠ WARNING - Risk of accident or injury when using the cup holder while the vehicle is moving

The cup holder cannot secure containers while the vehicle is moving.

If you use a cup holder while the vehicle is moving, the container may be flung around and liquids may be spilled. The vehicle occupants may come into contact with the liquid and if it is hot, they could be scalded. You could be distracted from traffic conditions and you may lose control of the vehicle.

- ▶ Only use the cup holder when the vehicle is stationary.
- ▶ Only use the cup holder for containers of the right size.
- ▶ Close the container, particularly if the liquid is hot.

! NOTE Damage to the cup holder

The cup holder can be damaged when folding back the rear armrest. When open, the cup holder can be damaged by body weight.

- ▶ The rear armrest can only be folded back when the cup holder is closed.
- ▶ Do not sit or support yourself on the cup holder when it is open.

! NOTE Damage to the vehicle caused by spilled liquids

If liquids are spilled in the vehicle, parts of the vehicle may be damaged.

- ▶ Always securely close containers containing liquids that you have brought with you.
- ▶ Clean the vehicle as soon as possible if liquids are spilled.
- ▶ If larger quantities of liquids are spilled, have the vehicle checked in a qualified specialist workshop.

NOTE Damage to the rear armrest due to body weight

When folded out, the rear armrest can be damaged by body weight.

- ▶ Do not sit or support yourself on the rear seat armrest.

WARNING Risk of fire and injury from hot cigarette lighter

You can suffer burns if you touch the hot heating element or the hot socket of the cigarette lighter.

In addition, flammable materials can catch fire if:

- you drop the hot cigarette lighter.
- children e.g. hold the hot cigarette lighter to objects.
- ▶ Always hold the cigarette lighter by the knob.
- ▶ Always make sure that the cigarette lighter is out of the reach of children.

- ▶ Never leave children unattended in the vehicle.

WARNING Risk of burns from the tailpipe and tailpipe trims

The exhaust tailpipe and tailpipe trims can become very hot. If you come into contact with these parts of the vehicle, you could burn yourself.

- ▶ Always be particularly careful around the tailpipe and the tailpipe trims and supervise children especially closely in this area.
- ▶ Allow vehicle parts to cool down before touching them.

i Leather is a natural product. It exhibits natural surface characteristics, such as differences in structure, marks caused by growth and injury or subtle color differences. These surface characteristics are particular to leather, and are not material defects. Leather is also subject to a natural aging process that changes the surface characteristics.

The driving characteristics of your vehicle are dependent on the distribution of the load within the vehicle. You should bear the following in mind when loading the vehicle:

- Never allow the payload including occupants to exceed the gross vehicle weight rating or the gross axle weight rating for the vehicle. The values are specified on the vehicle identification plate on the vehicle's B-pillar.
- The load must not protrude above the upper edge of the seat backrests.
- Always place the load behind unoccupied seats if possible.
- Secure the load using the tie-down eyes and distribute the tension evenly.

Notes on driving with a roof load

- Distribute the roof load and vehicle load evenly, and place heavy objects at the bottom. Also observe the notes on loading the vehicle.
- Drive carefully, avoiding abrupt starting, braking and steering as well as fast cornering.

- When carrying a roof load or when the vehicle is fully loaded or occupied, select drive program **E** or **C**. These are configured for good stability (→ page 153).
- i** Further information about stowage compartments and stowage facilities can be found in the Digital Operator's Manual.

Stowage spaces in the vehicle interior

Overview of the front storage compartments

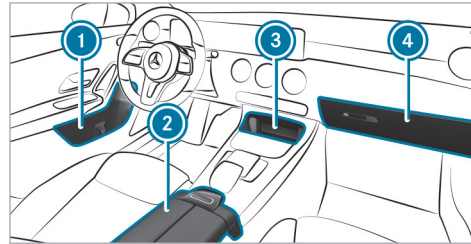

- 1 Storage spaces in the doors
- 2 Storage compartment in the armrest with a multimedia and USB port
- 3 Storage compartment in the front center console with a USB port
- 4 Glove box

Locking/unlocking the glove box

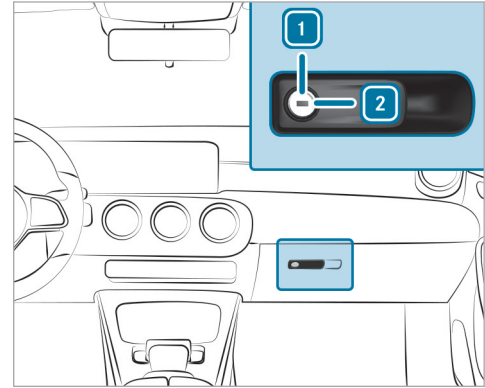

- ▶ Turn the emergency key a quarter turn clockwise **2** (to lock) or counter-clockwise **1** (to unlock).

Through-loading feature in the rear bench seat (EASY-PACK Quickfold)

Folding the rear seat backrest forwards

⚠ WARNING Risk of accident if the rear bench seat, rear seat and seat backrest are not engaged

The rear bench seat, rear seat and seat backrest may fold forwards, even when you are driving.

- As a result, the vehicle occupant will be pushed into the seat belt with increased force. The seat belt will not be able to protect as intended and could cause additional injury.
 - Objects or loads in the trunk or cargo compartment will not be restrained by the seat backrest.
- ▶ Make sure that the rear bench seat, the rear seat and the seat backrest are engaged before every trip.

If the seat backrests are not engaged and locked in place, the lock verification indicator will be red.

Requirements:

- To fold the center seat backrest forwards: the center seat backrest has been unlocked.

You can fold the center and outer seat backrests forwards separately.

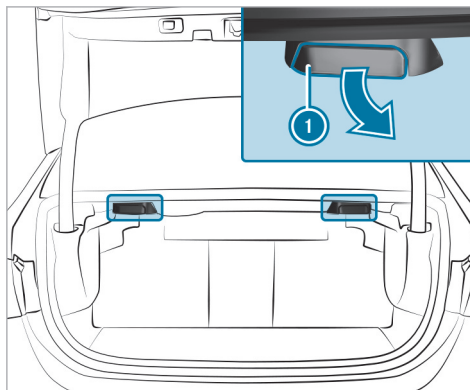

Vehicles with a memory function: If necessary, when the seat backrest in the rear passenger compartment is folded forward, the front seat will move forwards slightly to avoid a collision.

- ▶ If necessary, fully insert the head restraints in the rear seat backrest.

The release handles are located beneath the rear shelf.

- ▶ **To fold the left and right seat backrests forward:** pull right or left release handle ① and fold the corresponding seat backrest forwards.

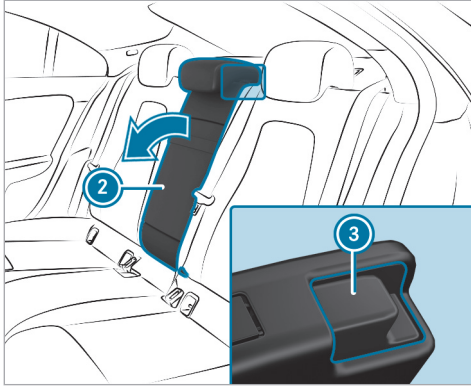

- ▶ **To fold the center seat backrest forwards:** pull release catch ③ of seat backrest ② forwards.
- ▶ Fold seat backrest ② forwards.
- ▶ Move the driver's or front passenger seat back if necessary.

Folding the rear seat backrest back

⚠ WARNING Risk of becoming trapped when adjusting the seats

When you adjust a seat, you may trap yourself or a vehicle occupant.

- ▶ When adjusting a seat, make sure that no one has any body parts in the sweep of the seat.

❗ NOTE Damage caused by trapping the seat belt when folding back the seat backrest

The seat belt could become trapped and thus damaged when the seat backrest is folded back.

- ▶ Make sure that the seat belt is not trapped when folding back the seat backrest.

- ▶ Move the driver's or front passenger seat forwards, if necessary.

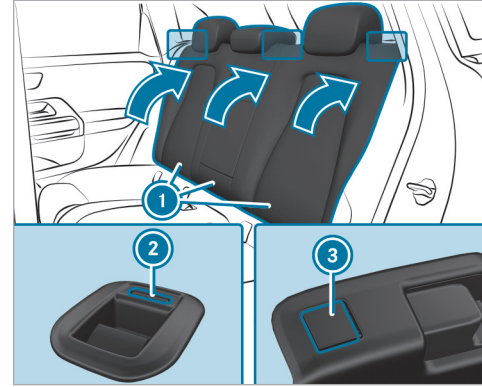

- ▶ Fold the corresponding seat backrest ① back until it engages.

Left and right seat backrests: if the seat backrest is not engaged and locked in place, red lock verification indicator ② will be visible.

Center seat backrest: if the seat backrest is not engaged and locked in place, red lock verification indicator ③ will be visible.

■ Locking the release catch of the center rear seat backrest

Requirements:

- The left and center seat backrests are engaged and joined together.

You can lock the center seat backrest release catch if you want to secure the trunk against unauthorized access. The center seat backrest can then be folded forwards only together with the left seat backrest.

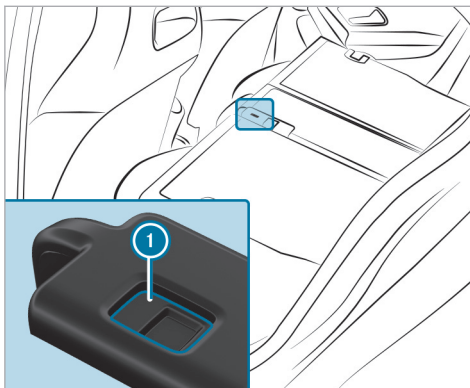

- ▶ Fold the center and left seat backrests forwards.
- ▶ **To lock or unlock:** slide catch ① upwards or downwards.

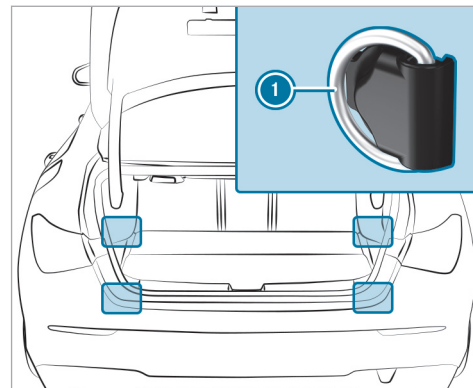

- ① Tie-down eyes (vehicles with through-loading feature in the rear bench seat)

Overview of the tie-down eyes

Observe the notes on loading the vehicle
(→ page 112).

Attaching a roof luggage rack

⚠ WARNING Risk of accident due to exceeding the maximum roof load

The vehicle center of gravity and the usual driving characteristics as well as the steering and braking characteristics alter.

If you exceed the maximum roof load, the driving characteristics, as well as steering and braking, will be greatly impaired.

- ▶ Never exceed the maximum roof load and adjust your driving style.

Vehicle-specific weight information can be found on the vehicle identification plate.

! NOTE Vehicle damage due to failure to observe the maximum permissible clearance height

If the vehicle height exceeds the maximum permissible clearance height, the roof and other vehicle parts may be damaged.

- ▶ Please observe the maximum clearance height indicated.
- ▶ If the vehicle exceeds the permissible clearance height, do not drive in.
- ▶ Take the modified vehicle height into account in the case of roof superstructures or other carrier systems.

! NOTE Vehicle damage from non-approved roof luggage racks

The vehicle could be damaged by roof luggage racks that have not been tested and approved for Mercedes-Benz.

- ▶ Use only roof luggage racks tested and approved for Mercedes-Benz.
- ▶ Depending on the vehicle equipment, ensure that the sliding sunroof can be fully raised when the roof luggage rack is installed.
- ▶ Depending on the vehicle equipment, ensure that the trunk lid can be fully

opened when the roof luggage rack is installed.

- ▶ Position the load on the roof luggage rack in such a way that the vehicle will not sustain damage even when it is in motion.

! NOTE Damage to the panorama roof with power tilt/sliding panel due to non-approved roof luggage racks

The panorama roof with power tilt/sliding panel may be damaged by the roof luggage rack if you attempt to open it when using a roof luggage rack not tested and approved for Mercedes-Benz.

- ▶ When a roof luggage rack is installed, open the panorama roof with power tilt/sliding panel only if this has been tested and approved for Mercedes-Benz.

The panorama roof with power tilt/sliding panel may be raised to allow ventilation of the vehicle interior.

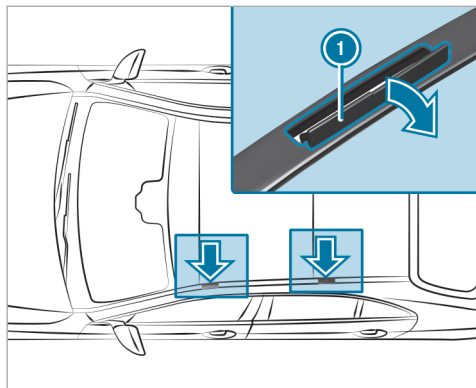

- ▶ Secure the roof luggage rack to the fastening points beneath covers ①.
- ▶ Comply with the installation instructions of the roof luggage rack manufacturer.
- ▶ Secure the load on the roof luggage rack.

Sockets

Using the 12 V socket

Requirements

- Only devices up to a maximum of 180 W (15 A) are permissible.

Depending on the vehicle equipment, the vehicle has the following 12 V sockets:

- In the stowage compartment in the front center console
- In the trunk

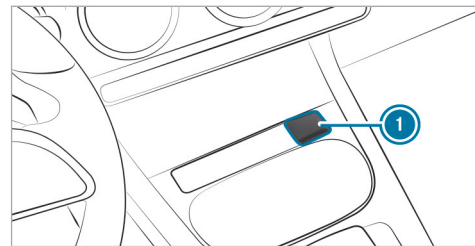

Example: 12 V socket in the stowage compartment in the front center console

- ▶ Fold up socket cap ①.
- ▶ Insert the plug of the device.

12 V socket in the stowage compartment with cover: if you have connected a device to the 12 V socket, leave the cover of the stowage compartment open.

! NOTE Damage to the covers

The covers may be damaged and scratched when being opened.

- ▶ Do not use metallic or hard objects.

- ▶ Fold covers ① carefully upwards in the direction of the arrow.

Using the 115 V socket in the rear passenger compartment

⚠ DANGER Risk of fatal injuries due to a damaged connecting cable or a damaged socket

You could receive an electric shock if the connecting cable or the 115 V power socket is pulled out of the trim or is damaged or wet.

- ▶ Use only connecting cables that are dry and free of damage.
- ▶ When the vehicle is switched off, make sure that the 115 V power socket is dry.
- ▶ Immediately have the 115 V power socket checked or replaced at a qualified specialized workshop if it is damaged or has been pulled out of the trim.
- ▶ Never plug the connecting cable into a 115 V power socket that is damaged or has been pulled out of the trim.

⚠ DANGER Risk of death due to using the socket incorrectly

In particular, you could receive an electric shock:

- If you touch the inside of the socket
 - If you insert unsuitable devices or objects into the socket
- ▶ Do not touch the inside of the socket.
 - ▶ Only connect suitable devices to the socket.

Make sure that no liquids get into the 115 V socket.

When the 115 V socket is not in use, keep the socket flap closed.

Requirements

- Only connect devices with a suitable plug which conforms to the standards specific to the country you are in.
- Only connect devices up to a maximum of 150 W.
- Do not use multiple socket outlets.

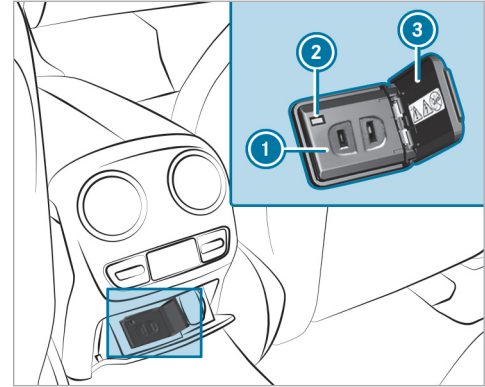

- ▶ Open socket flap ③.
- ▶ Insert the plug of the device into 115 V socket ①.
When the on-board electrical system voltage is sufficient, indicator lamp ② lights up.

USB port in the rear passenger compartment

- ⓘ Depending on the vehicle equipment, the design of the stowage compartment and the number of USB ports in the rear center console may vary.

When the vehicle is switched on, you can charge a USB device, such as a mobile phone, at the USB port using a suitable charging cable.

Wireless charging of the mobile phone and connection with the exterior antenna

Notes on wireless charging of a mobile phone

⚠ WARNING Risk of injury due to objects being stowed incorrectly

If objects in the vehicle interior are stowed incorrectly, they can slide or be thrown around and hit vehicle occupants. In addition, cup holders, open stowage spaces and mobile phone receptacles cannot always retain all objects within.

There is a risk of injury, particularly in the event of sudden braking or a sudden change in direction.

- ▶ Always stow objects so that they cannot be thrown around in such situations.
- ▶ Always make sure that objects do not protrude from stowage spaces, parcel nets or stowage nets.
- ▶ Close the lockable stowage spaces before starting a journey.
- ▶ Always stow and secure heavy, hard, pointed, sharp-edged, fragile or bulky objects in the trunk/cargo compartment.

Observe the notes on loading the vehicle.

⚠ WARNING Risk of fire from placing objects in the mobile phone storage compartment

Placing other objects in the mobile phone storage compartment could constitute a fire hazard.

- ▶ Apart from a mobile phone, do not place any other objects in the mobile phone storage compartment, especially those made of metal.

! NOTE Damage to objects caused by placing them in the mobile phone storage compartment

If objects are placed in the mobile phone storage compartment, these may be damaged by electromagnetic fields.

- ▶ Do not place credit cards, storage media, ski passes or other objects sensitive to electromagnetic fields in the mobile phone storage compartment.

! NOTE Damage to the mobile phone storage compartment caused by liquids

If liquids enter the mobile phone storage compartment, the compartment may be damaged.

- ▶ Ensure that no liquids enter the mobile phone stowage compartment.

Please observe the following notes on wireless charging of a mobile phone.

- Depending on the vehicle equipment, the mobile phone is connected to the vehicle's exterior antenna via the charging module.
- The charging function and wireless connection of the mobile phone to the vehicle's exterior antenna are only available if the vehicle is switched on.
- It may not be possible to charge small mobile phones in every position in the mobile phone stowage compartment.
- It may not be possible to charge mobile phones that are too large to lie flat in the mobile phone stowage compartment, or to connect them with the vehicle's exterior antenna.
- The mobile phone may heat up during the charging process. In particular, this can depend on the applications (apps) that are open in the background.

- To ensure more efficient charging and connection with the vehicle's exterior antenna, remove the protective cover from the mobile phone. This does not apply to protective covers which are designed for wireless charging.

Charging a mobile phone wirelessly

Requirements

- The mobile phone is suitable for wireless charging.

A list of compatible mobile phones can be found at: <https://www.mercedes-benz-mobile.com>.

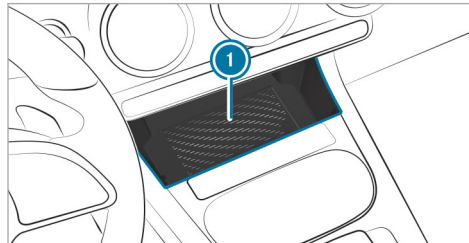

- ▶ Place the mobile phone as close to the center of the marked surface on mat ① as possible with the display facing upwards. When a message is shown in the multimedia system, the mobile phone is being charged. Malfunctions during the charging process are shown in the central display.

- ① The mat can be removed for cleaning, e.g. using clean, lukewarm water.

Stowage compartment without cover

Make sure the mobile phone is properly stored and secured to prevent it from falling out while you are driving.

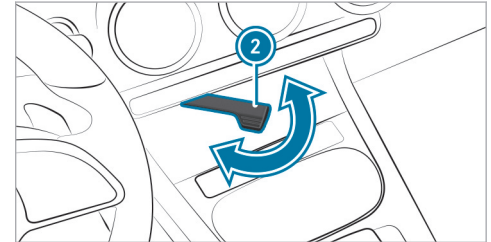

- ▶ To secure the mobile phone: swing lever ② out.

Installing/removing the floor mats

⚠ WARNING Risk of accident due to objects in the driver's footwell

Objects in the driver's footwell may impede pedal travel or block a depressed pedal.

This will jeopardize the operating- and road safety of the vehicle.

- ▶ Stow all objects in the vehicle securely so that they cannot get into the driver's footwell.
- ▶ Make sure that there is always sufficient clearance for the pedals.
- ▶ Always install the floor mats securely and as prescribed.
- ▶ Do not use loose floor mats and do not place floor mats on top of one another.

Installing floor mats

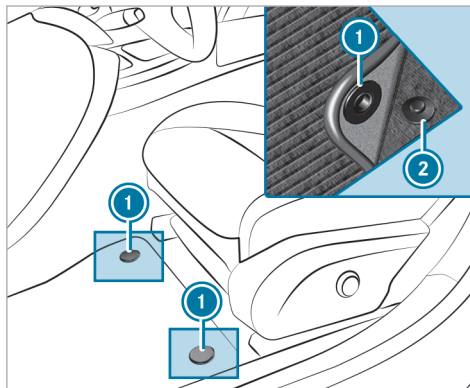

- ▶ Slide the corresponding seat backwards and lay the floor mat in the footwell.
- ▶ Press studs ① onto holders ②.
- ▶ Adjust the corresponding seat.

Removing floor mats

- ▶ Pull the floor mat off holders ②.

- ▶ Remove the floor mat.

Exterior lighting

Information about lighting systems and your responsibility

The various lighting systems of the vehicle are only aids. The driver of the vehicle is responsible for correct vehicle illumination in accordance with the prevailing light and visibility conditions, legal requirements and traffic situation.

Light switch

Operating the light switch

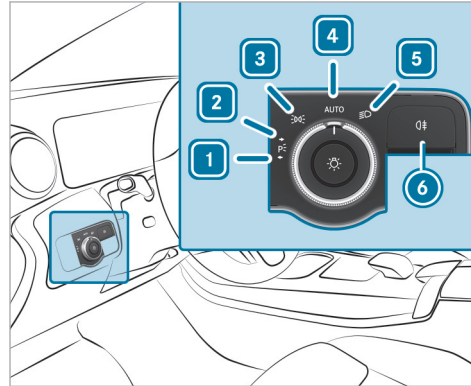

- 1 Left-hand parking lights
- 2 Right-hand parking lights
- 3 Standing lights and license plate lamp
- 4 **AUTO** Automatic driving lights (preferred light switch position)

- 5 Low beam/high beam
- 6 Activates or deactivates the rear fog light.

When low beam is activated, the indicator lamp for the standing lights will be deactivated and replaced by the low-beam indicator lamp.

▶ Always park your vehicle safely using sufficient lighting, in accordance with the relevant legal stipulations.

! **NOTE** Battery discharging by operating the parking lamps

Do not have the parking lamps switched on over a period of several hours.

If the battery is insufficiently charged, the standing lights or parking lights will be switched off automatically to facilitate the next engine start.

The exterior lighting (except standing and parking lights) will switch off automatically when the driver's door is opened.

- Observe the notes on locator lighting (→ page 130).

Automatic driving lights function

When the vehicle is switched on, the standing lights, low beam and daytime running lights will be switched on automatically depending on the ambient light.

⚠ WARNING Risk of accident when the low beam is switched off in poor visibility



When the light switch is set to **AUTO**, the low beam may not be switched on automatically if there is fog, snow or other causes of poor visibility such as spray.

- ▶ In such cases, turn the light switch to .

The automatic driving lights are only an aid. You are responsible for the vehicle lighting.

Switching the rear fog light on/off

Requirements

- The light switch is in the  or **AUTO** position.
- ▶ Press button .

Please observe the country-specific laws on the use of rear fog lamps.

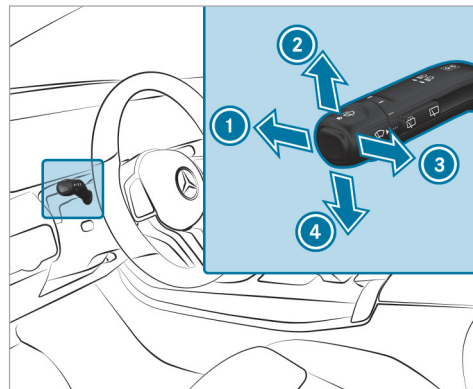

Operating the combination switch for the lights



- 1 High beam
- 2 Turn signal light, right
- 3 Headlamp flashing
- 4 Turn signal light, left

- ▶ Use the combination switch to select the desired function.

Switching on high beam

- ▶ Turn the light switch to the  or **AUTO** position.
- ▶ Push the combination switch in the direction of arrow ①.
When high beam is activated, the indicator lamp for low beam  will be deactivated and replaced by the indicator lamp for high beam .

Switching off high beam

- ▶ Push the combination switch in the direction of arrow ① or pull it in the direction of arrow ③.

Headlamp flashing

- ▶ Pull the combination switch in the direction of arrow ③.

Turn signal lights

- ▶ **To indicate briefly:** push the combination switch briefly to the point of resistance in the direction of arrow ② or ④.
The corresponding turn signal light will flash three times.
- ▶ **To indicate permanently:** push the combination switch beyond the point of resistance in the direction of arrow ② or ④.

Activating/deactivating the hazard warning lights

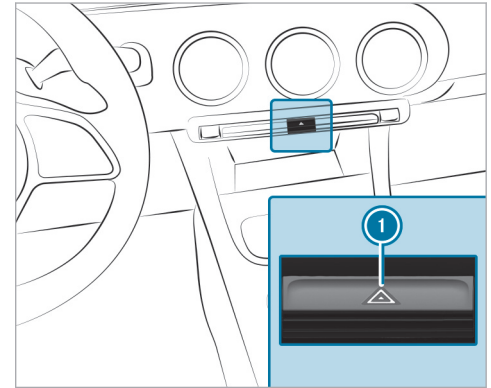

- ▶ Press button ①.

The hazard warning lights will switch on automatically if:

- the air bag has been deployed
- an emergency stop has been initiated (→ page 192)

Cornering light

■ Cornering light function

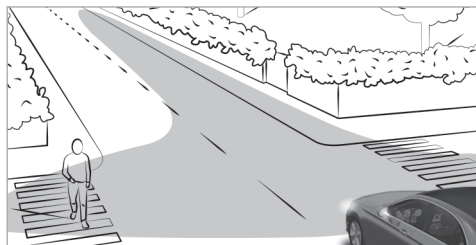

The cornering light improves the illumination of the road over a wide angle in the turning direction, enabling better visibility on tight bends, for example. The cornering light will be activated only when low beam is switched on.

The function will be active in the following cases:

- At speeds below 25 mph (40 km/h) when the turn signal light is switched on or the steering wheel is turned

- At speeds between 25 mph (40 km/h) and 43 mph (70 km/h) and when the steering wheel is turned

Active headlamps

■ Active headlamps function

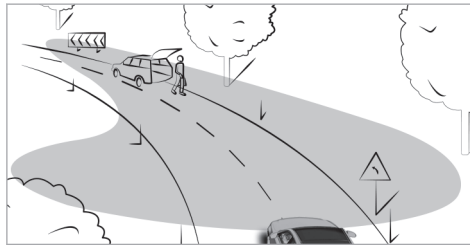

- The headlamps follow the steering movements.
- Relevant areas are better illuminated during a journey.

The functions will be active when high beam is switched on.

Adaptive Highbeam Assist

■ Adaptive Highbeam Assist function

⚠ WARNING Risk of accident despite Adaptive Highbeam Assist

Adaptive Highbeam Assist does not react to:

- Road users without lights, e.g. pedestrians
- Road users with poor lighting, e.g. cyclists
- Road users whose lighting is obstructed, e.g. by a barrier

On very rare occasions, Adaptive Highbeam Assist may fail to recognize other road users with their own lighting, or may recognize them too late.

In these, or in similar situations, the automatic high beam will not be deactivated or will be activated despite the presence of other road users.

▶ Always observe the road and traffic conditions carefully and switch off the high beam in good time.

Adaptive Highbeam Assist cannot take into account road, weather or traffic conditions.

Detection may be restricted in the following cases:

- in poor visibility, e.g. fog, heavy rain or snow
- if there is dirt on the sensors or the sensors are obscured

Adaptive Highbeam Assist is only an aid. You are responsible for adjusting the vehicle's lighting to the prevailing light, visibility and traffic conditions.

- ① Adaptive Highbeam Assist is an on-demand feature (→ page 25).

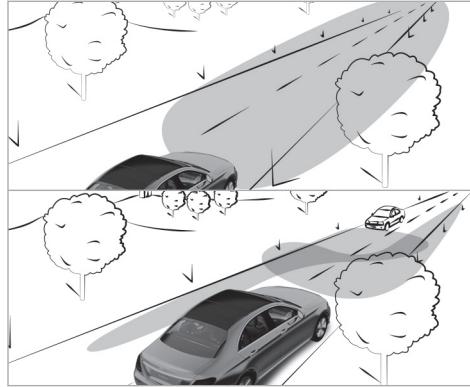

Adaptive Highbeam Assist automatically switches between the following types of light:

- Low beam
- High beam

At speeds above 19 mph (30 km/h):

- If no other road users are detected, high beam will switch on automatically.

High beam will switch off automatically in the following cases:

- At speeds below 16 mph (25 km/h)
 - If other road users are detected
 - If street lighting is sufficient
- ① The system's optical sensor is located behind the windshield near the overhead control panel.

Switching Adaptive Highbeam Assist on/off

Switching on

- ▶ Turn the light switch to the **AUTO** position.
 - ▶ Switch on high beam using the combination switch.
- If Adaptive Highbeam Assist is activated, the  indicator lamp will light up on the driver's display.

Switching off

- ▶ Switch off high beam using the combination switch.

Setting the exterior lighting switch-off delay time

Multimedia system:

-  >> Settings >> Light
- >> Interior/Exterior Lighting
- >> Exterior Lighting Switch-off Delay

- ▶ Set a switch-off delay time.
After parking and locking the vehicle, the exterior lighting will be activated for the set time.

Activating/deactivating locator lighting

Multimedia system:

-  >> Settings >> Light
- >> Interior/Exterior Lighting

- ▶ Activate or deactivate **Locator Lighting**.





When the function is activated, the exterior lighting will light up for 40 seconds after the vehicle is unlocked or the driver's door is opened when the vehicle is parked and not locked. When you start the vehicle, the locator lighting will be deactivated and the automatic driving lights activated.

Interior lighting

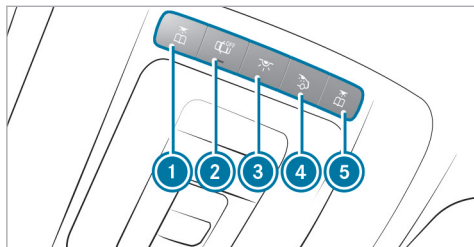
Adjusting the interior lighting

Front overhead control panel



- ①  Front left reading lamp
- ②  Automatic interior lighting control
- ③  Front interior lighting
- ④  Rear interior lighting
- ⑤  Front right reading lamp

- ▶ **To switch on or off:** press button ① - ⑤ accordingly.

Operating unit inside the grab handle (rear passenger compartment)

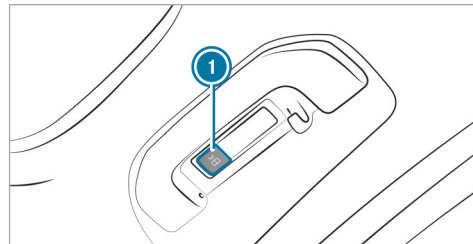

- ①  Rear reading lamp

- ▶ **To switch on or off:** press the ① button.

Adjusting the ambient lighting

Multimedia system:

-  >> Comfort >> Ambient Light

Setting the color

- ▶ Select **Color**.
- ▶ Select **Monochrome** or **Multi-color**.

- ▶ Set the desired color or color scheme.

Adjusting the brightness

- ▶ Select **Brightness**.
- ▶ Adjust the brightness.
- ⓘ Depending on the ambient light conditions, the ambient lighting will automatically switch between day and night modes.

Activating the brightness for zones

- ▶ Select **Brightness**.
- ▶ Switch off **Link Zones**.
The **Direct**, **Indirect** and **Accents** zones can be set separately.

Activating effects

- ▶ Select **Effects**.
- ▶ Activate the desired effect.
- ⓘ Different effects will be available depending on the vehicle equipment.

Multi-color Animation

- The chosen color combination will change at predefined intervals.

Climate

- If changes are made to the temperature setting in the vehicle, the color of the ambient lighting will change briefly.

Greeting

- When you get into the vehicle, a special color animation will play.

Switching the interior lighting switch-off delay time on/off

Multimedia system:



-  ▶ Settings ▶ Light
- ▶▶ Interior/Exterior Lighting
- ▶▶ Interior Lighting Switch-off Delay
- ▶ Activate or deactivate **Interior Lighting Switch-off Delay**.
If this function is active, the interior lighting will be switched on for a short time after the end of the journey.

Windshield wiper and windshield washer system

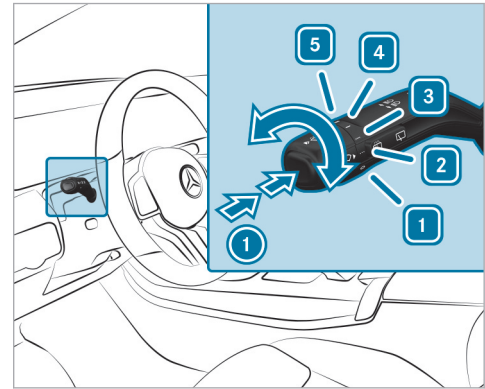
Switching the windshield wipers on or off



- | | | |
|----------|----------|----------------------------|
| 1 | 0 | Windshield wipers off |
| 2 | ... | Automatic wiping, normal |
| 3 | | Automatic wiping, frequent |
| 4 | — | Continuous wiping, slow |
| 5 | == | Continuous wiping, fast |

- ▶ Turn the combination switch to the corresponding position **1** - **5**.
- ▶  **Single wipe:** press button **1** as far as the pressure point.
- ▶  **Wiping with washer fluid:** press button **1** beyond the pressure point.
- ▶ **i** Observe the notes on washing the vehicle in a car wash (→ page 290).

Replacing the windshield wiper blades

⚠ WARNING Risk of becoming trapped if the windshield wipers are switched on while wiper blades are being replaced

If the windshield wipers begin to move while you are changing the wiper blades, you can be trapped by the wiper arm.

- ▶ Always switch off the windshield wipers and vehicle before changing the wiper blades.

Moving the wiper arms into the replacement position

- ▶ Switch the vehicle on and then off again immediately.
- ▶ Within around 15 seconds, press and hold the  button on the combination switch for approximately three seconds (→ page 131). The wiper arms will move into the replacement position.

Removing the wiper blades

- ▶ Fold the wiper arms away from the windshield.

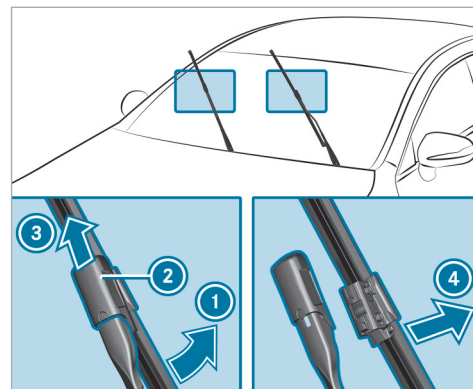

- ▶ Hold the wiper arm with one hand. With the other hand, turn the wiper blade away from the wiper arm in the direction of arrow **1** as far as it will go.
- ▶ Slide catch **2** in the direction of arrow **3** until it engages in the removal position.
- ▶ Remove the wiper blade from the wiper arm in the direction of arrow **4**.

Installing the wiper blades

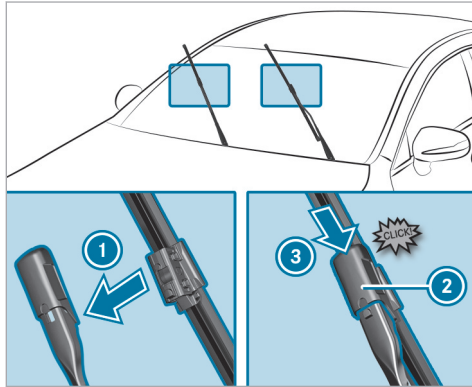

- ▶ Insert the new wiper blade into the wiper arm in the direction of arrow ①.
- ▶ Slide catch ② in the direction of arrow ③ until it engages in the locking position.
- ▶ Make sure that the wiper blade is seated correctly.
- ▶ Fold the wiper arms back onto the windshield.

- ▶ Switch on the vehicle.
 - ▶ Press the  button on the combination switch (→ page 131). The wiper arms will return to their original positions.
 - ▶ Switch off the vehicle.
- ① Check the condition of the wiper blades regularly and replace them in the event of visible damage or ongoing smearing.

Service indicator

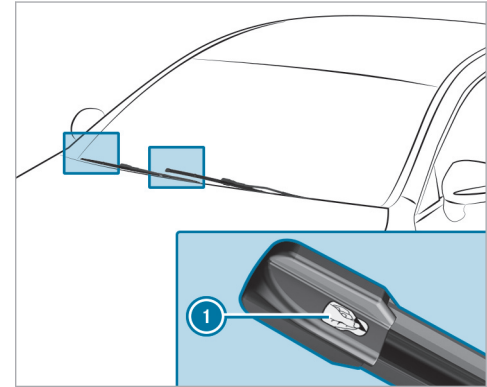

- ▶ Remove protective film ① from the service indicators on the tips of the newly installed wiper blades.

When the color of the service indicator changes from black to yellow, replace the wiper blades.

- ① The time it takes for the color to change will vary depending on the usage conditions.

Mirrors

Operating the outside mirrors

⚠ WARNING Risk of accident due to adjusting the vehicle settings while the vehicle is in motion

You could lose control of the vehicle in the following situations in particular:

- If you adjust the driver's seat, the head restraint, the steering wheel or the mirror while the vehicle is in motion
- If you fasten your seat belt while the vehicle is in motion

▶ Before starting the vehicle: in particular, adjust the driver's seat, head restraint, steering wheel and mirror, and fasten your seat belt.

⚠ WARNING Risk of accident due to misjudgment of distance when using the front-passenger mirror

The outside mirror on the front passenger side reflects objects on a smaller scale. The objects in view are in fact closer than they appear.

▶ Therefore, always look over your shoulder to check the actual distance between you and the road users traveling behind you.

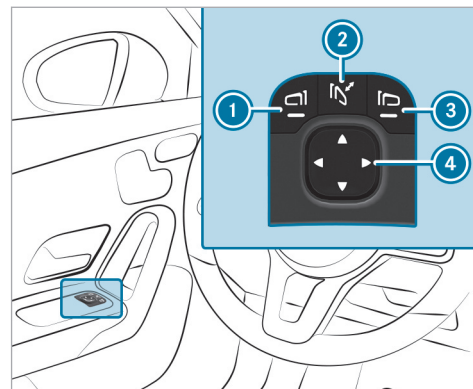

▶ **To fold in or out:** briefly press button ②.

▶ **To adjust:** use button ① or ③ to select the outside mirror to be adjusted.

▶ Use button ④ to adjust the position of the mirror glass.

❗ If the battery has been disconnected or completely discharged, you will have to reset the outside mirrors. Only then will the automatic mirror folding function work properly.

▶ **To reset:** briefly press button ②.

An outside mirror that has been pushed out of position can be engaged in position again as follows:

▶ **Vehicles without electrically folding outside mirrors:** Manually move the outside mirror into the correct position.

▶ **Vehicles with electrically folding outside mirrors:** Press and hold button ②.
You will hear a click. The outside mirror will now be set to the correct position.

Automatic anti-glare mirrors function

⚠ WARNING Risk of acid burns and poisoning due to the anti-glare mirror electrolyte

Electrolyte may escape if the glass in an automatic anti-glare mirror breaks.

The electrolyte is hazardous to health and causes irritation. It must not come into contact with your skin, eyes, respiratory organs or clothing or be swallowed.

▶ If you come into contact with electrolyte, observe the following:

- Immediately rinse the electrolyte from your skin with water and seek medical attention.
- If electrolyte comes into contact with your eyes, immediately rinse them thoroughly with clean water and seek medical attention.
- If the electrolyte is swallowed, immediately rinse your mouth out thoroughly. Do not induce vomiting. Seek medical attention immediately.
- Immediately change out of clothing which has been contaminated with electrolyte.
- If an allergic reaction occurs, seek medical attention immediately.

The inside rear-view mirror and the outside mirror on the driver's side will automatically go into anti-glare mode if light from a headlamp hits the sensor on the inside rear-view mirror.

System limits

The system will not go into anti-glare mode if:

- The vehicle is switched off.
- Reverse gear is engaged.
- The interior lighting is switched on.

Front-passenger outside mirror parking position function

The parking position makes parking easier.

The front-passenger outside mirror will swivel downwards in the direction of the rear wheel on the front passenger's side when:

- The parking position is stored (→ page 136).
- The front-passenger mirror is selected.
- Reverse gear is engaged.

The front-passenger outside mirror will move back to its original position when:

- You shift the transmission to another transmission position.
- You are traveling at a speed greater than 9 mph (15 km/h).
- You press the button for the outside mirror on the driver's side.

Storing the parking position of the front-passenger outside mirror using reverse gear

Storing

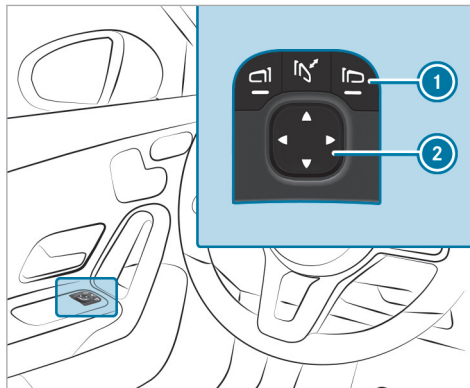

- ▶ Press button ① to select the front-passenger outside mirror.
- ▶ Engage reverse gear.

- ▶ Move the front-passenger outside mirror into the desired parking position using button ②.

Calling up

- ▶ Press button ① to select the front-passenger outside mirror.
- ▶ Engage reverse gear. The front-passenger outside mirror will move into the stored parking position.

Overview of climate control systems

Notes on climate control

For the air-conditioning system, pollution level monitoring and air filtration to function correctly, an interior air filter must always be used. Make sure that the filter is installed correctly. Use filters recommended and approved by Mercedes-Benz. Always have maintenance work carried out at a qualified specialist workshop.

Overview of the air conditioning control panel

The indicator lamps on the buttons indicate that the corresponding functions are activated.

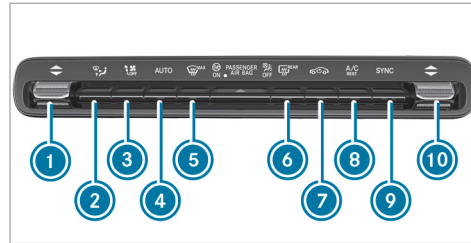

THERMOTRONIC air conditioning control panel

- ① Sets the temperature on the driver's side
- ② Sets the air distribution
- ③ Sets the airflow or switches off climate control
- ④ **AUTO** Sets climate control to automatic mode (→ page 138)
- ⑤ Defrosts the windshield
- ⑥ Switches the rear window defroster on/off
- ⑦ Switches air-recirculation mode on/off (→ page 139)

- ⑧ Switches the A/C function on/off (→ page 138)
Switches the residual heat on/off (→ page 139)
 - ⑨ **SYNC** Activates or deactivates synchronization (→ page 139)
 - ⑩ Sets the temperature on the front passenger side
- ⓘ Residual heat can be used only for vehicles with a diesel engine or with a stationary heater in conjunction with the THERMOTRONIC air conditioning control panel.

Operating the climate control system



Switching climate control on/off

- ▶ **To switch on:** set the airflow to level 1 or higher using the button.
- ▶ **To switch off:** set the airflow to level 0 using the button.

If climate control is switched off, the windows may fog up more quickly. Switch climate control off only briefly.

Switching the A/C function on/off using the air conditioning control panel

The A/C function heats, cools and dehumidifies the vehicle's interior air.

- ▶ Press the  /  button.

Switch off the A/C function only briefly; otherwise, the windows may fog up more quickly.

Condensation may drip from the underside of the vehicle when cooling mode is active. This is not indicative of a malfunction.

Activating/deactivating the A/C function via the air-conditioning menu

Multimedia system:

- ↳ Climate Menu ▶▶ First Row of Seats

Depending on the external conditions, support for improved cooling and dehumidification of the inte-

rior air will be provided when the A/C function is activated. If it is not possible to operate the A/C function on the climate bar on the central display, switch the function on or off in the climate menu of the central display.

- ▶ Select A/C (A/C).

Setting climate control to automatic

In automatic mode, the set temperature is controlled and maintained at a constant level by the air supply.



- ▶ Press button .
- ▶ **To switch to manual mode:** press the  or  button.

In automatic mode, you can choose between five different air quantities using the  button. Automatic mode is retained.

Setting air distribution using the air conditioning menu

Multimedia system:

- ↳ Climate Menu

- ▶ Select **First Row of Seats** or **Second Row of Seats**.
- ▶ To set air distribution: select ,  or .
- ▶ Set the airflow.

- ⓘ When the air conditioning system is switched on, at least one zone is always active. However, several air distribution options can be selected at the same time, for example to set the climate control for the vehicle interior and the footwells simultaneously. The  climate control for the windshield can only be selected for the first seat row. When automatic mode is active, the buttons for setting the air distribution are automatically deactivated. When the air conditioning system is switched off, the buttons remain operable and the last setting is saved.

Switching the synchronization function on/off via the air-conditioning control panel

Requirements:

- The vehicle is not equipped with a stationary heater.

Climate control can be set centrally using the synchronization function. The temperature and air distribution settings for the driver's side will be adopted automatically for the front passenger side.

- ▶ Press the **SYNC** button.

The synchronization function will switch off if the settings for any of the other climate zones are changed.

Switching the synchronization function on/off via the air-conditioning menu

Multimedia system:

- ▶ Climate Menu ▶ First Row of Seats

The synchronization function controls the climate control centrally. The driver's settings for temper-

ature, airflow and air distribution are automatically adopted for each climate zone.

- ▶ Select **SYNC** (SYNC).

Defrosting the windows

Windows fogged up on the inside

- ▶ Press the **AUTO** button.
- ▶ If the windows remain fogged up: press the **MAX** button.

Windows fogged up on the outside

- ▶ Switch on the windshield wipers.
- ▶ Press the **AUTO** button.

Switching air-recirculation mode on/off

- ▶ Press the **RECIRC** button.
The interior air will be recirculated.

Air-recirculation mode automatically switches to fresh air mode after a while.

- ⓘ If air-recirculation mode is switched on, the windows may fog up more quickly. Switch on air-recirculation mode only briefly.

Switching the residual heat on/off (Canada)

Requirements

- The vehicle is parked.
- ⓘ Only vehicles with a diesel engine can use residual heat.

It is possible to make use of the residual heat from the engine to continue heating or ventilating the front compartment of the vehicle for approximately 30 minutes, depending on the temperature set.

- ▶ **To activate:** press the **A/C RES** button.

Residual heat will be switched off automatically.

Air vents

Adjusting the front air vents

⚠ WARNING Risk of burns or frostbite due to being too close to the air vents

Very hot or very cold air can flow from the air vents.

- ▶ Make sure that all vehicle occupants always maintain a sufficient distance from the air vents.
- ▶ If necessary, direct the airflow to another area of the vehicle interior.

To guarantee the flow of fresh air through the air vents into the vehicle interior, note the following:

- Always keep the vents and ventilation grilles in the vehicle interior clear.
- Keep the air inlet free of residue build-up (→ page 289).

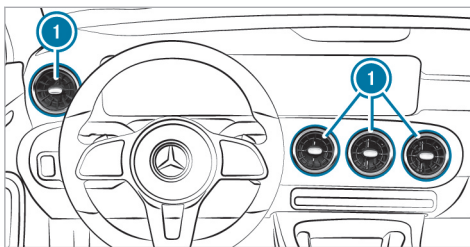

- ▶ **To open or close:** hold the center of air vent ① and turn it to the left (open) or right (closed) as far as it will go.
- ▶ **To set the airflow direction:** hold the center of air vent ① and move it up or down or to the left or right.

Adjusting the rear air vents

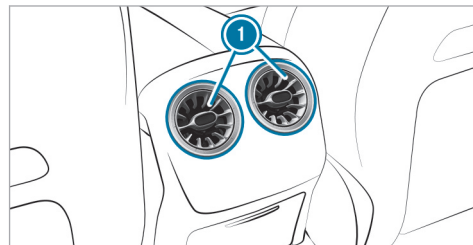

- ▶ **To open or close:** hold the center of air vent ① and turn it to the left or right as far as it will go.
- ▶ **To set the airflow direction:** hold the center of air vent ① and move it up or down or to the left or right.

Driving

Notes on Mercedes-AMG vehicles

Observe the notes on the following additional topics in the Supplement, as you may otherwise fail to recognize dangers:

- Reduction of engine output and engine torque
- AMG Real Performance Sound
- RACE START
- DRIFT MODE
- AMG RIDE CONTROL
- AMG steering-wheel buttons

Switching on the power supply or the vehicle

⚠ WARNING Risk of accident and injury due to children left unattended in the vehicle

If you leave children unattended in the vehicle, they could, in particular:

- open doors, thereby endangering other persons or road users.
- get out and be struck by oncoming traffic.
- operate vehicle equipment and become trapped, for example.

In addition, the children could also set the vehicle in motion by, for example:

- releasing the parking brake.
- changing the gearbox position.
- starting the vehicle.

- ▶ Never leave children unattended in the vehicle.
- ▶ When leaving the vehicle, always take the key with you and lock the vehicle.
- ▶ Keep the key out of reach of children.

Requirements

- The key is in the vehicle and is recognized.
- The brake pedal is not depressed.

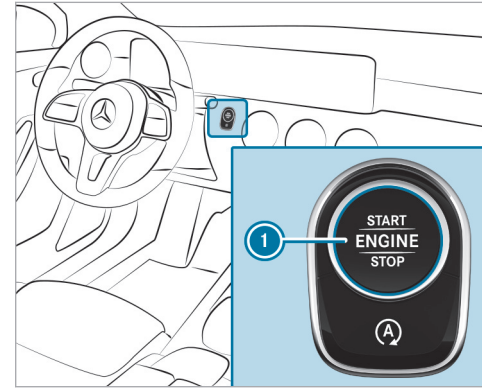

- ▶ **To switch on the power supply:** press button **1** once. You can, for example, switch on the windshield wipers.

The power supply will be switched off again if the following conditions are met:

- You open the driver's door.
- You press button **1** twice more.

▶ **To switch on the vehicle:** press button **1** twice.
Indicator and warning lamps will light up on the driver's display.

The vehicle will be switched off again if one of the following conditions is met:

- You do not start the vehicle within 15 minutes and the transmission is in position **P** or the electric parking brake is applied.
- You press button **1** once.

Starting the vehicle

Starting the vehicle with the start/stop button

⚠ DANGER Risk of death caused by exhaust gases

Combustion engines emit poisonous exhaust gases such as carbon monoxide. Inhaling these exhaust gases is hazardous to health and leads to poisoning.

- ▶ Never leave the engine or, if present, the auxiliary heating running in an enclosed space without sufficient ventilation.

⚠ WARNING Risk of fire due to flammable materials in the engine compartment or on the exhaust system

Flammable materials may ignite.

- ▶ Therefore, regularly check that there are no flammable foreign materials in the engine compartment or on the exhaust system.

Requirements:

- The key is in the vehicle and is detected.
- ▶ Shift the transmission to position **P** or **N**.
- ▶ Depress the brake pedal and press button **1** once.
- ▶ Keep the brake pedal depressed until the vehicle starts.
- ▶ If the vehicle does not start: switch off non-essential consumers and press button **1** once.
- ▶ If the vehicle still does not start and the **Place the Key in the Marked Space See Operator's Manual** display message appears on the driver display: start the vehicle with the key in the marked space (emergency operation mode) (→ page 143).
- i** You can switch off the vehicle while driving. To do this, press and hold button **1** for about three seconds or press button **1** three times within three seconds. Be sure to observe the safety notes concerning this under "Driving tips" (→ page 145).

Observe any information regarding display messages that may be shown on the driver display.

Starting the vehicle with the key in the storage compartment (emergency operation mode)

If the vehicle does not start and the **Place the Key in the Marked Space See Operator's Manual** message appears on the driver display, you can start the vehicle in emergency mode.

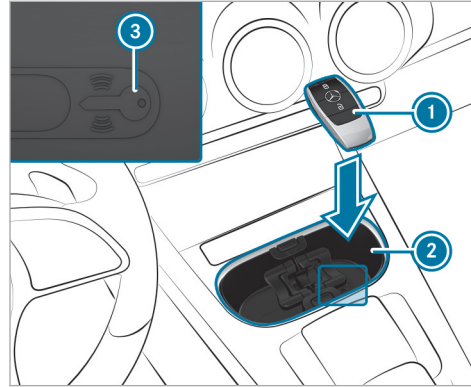

Storage compartment (example with cup holder without cover)

- ▶ Open the cover of the storage compartment ② if necessary.
- ▶ Make sure that the storage compartment ② is empty.
- ▶ Remove key ① from the key ring.

- ▶ Place the key ① on symbol ③ in the storage compartment ②.
The vehicle will start after a short time.
- ▶ If you remove the key ① from the storage compartment ②, it will still be possible to continue driving the vehicle. For further engine starts, however, key ① must be located on symbol ③ in the storage compartment ② during the entire journey.
- ▶ Have key ① checked at a qualified specialist workshop.

If the vehicle does not start:

- ▶ Place the key ① in the storage compartment ② and leave it there.
- ▶ Depress the brake pedal and start the vehicle using the start/stop button.
- ▶ Keep the brake pedal depressed until the vehicle starts.
- ⓘ You can switch on the power supply or the vehicle with the start/stop button (→ page 141).

Observe any information regarding display messages that may be shown on the driver display.

Starting the vehicle via Remote Online Services

■ Cooling or heating the vehicle interior before a drive

Ensure the following before starting the engine:

- The legal stipulations in the area where your vehicle is parked allow engine starting via smartphone.
- It is safe to start and run the engine where your vehicle is parked.
- The fuel tank is sufficiently full.
- The starter battery is sufficiently charged.

■ Charging the starter battery before a drive

You can receive a message on your smartphone when the state of charge of the starter battery is low. You can then start the vehicle with the smartphone to charge the battery. The vehicle will automatically be turned off after ten minutes.

Ensure the following before starting the engine:

- The legal stipulations in the area where your vehicle is parked allow engine starting via smartphone.
- It is safe to start and run the engine where your vehicle is parked.
- The fuel tank is sufficiently full.

■ Starting the vehicle (Remote Online)

⚠ WARNING Risk of crushing or entrapment due to unintentional starting of the engine

Limbs could be crushed or trapped if the engine is started unintentionally during service or maintenance work.

▶ Always secure the engine against unintentional starting before carrying out maintenance or repair work.

Requirements



- Park position **P** is selected.
- The anti-theft alarm system is not activated.
- The panic alarm is not activated.

- The hazard warning lights are off.
- The hood is closed.
- The doors are closed and locked.
- The windows and sliding sunroof are closed.

▶ Start the vehicle using the smartphone. After every vehicle start, the engine runs for ten minutes.

You can carry out a maximum of two consecutive starting attempts. You must start the vehicle once with the key before starting the vehicle again with the smartphone.

You can turn off the vehicle at any time as follows:

- via the Mercedes me App
- by pushing the button  or  on the key

i Further information can be found in the Mercedes me App.

Securing the engine against starting before carrying out maintenance or repair work:

▶ Turn on the hazard warning lights or unlock the doors.

- ▶ Open a side window or the sliding sunroof.

Breaking-in notes

To preserve the engine during the first 1000 miles (1500 km):

- Drive at varying road speeds and engine speeds.
- Do not drive faster than 85 mph (140 km/h).
- Drive the vehicle in drive program **[C]** or **[E]**.
- Then shift to the next higher gear at the very latest when the needle reaches the last third before the red area in the tachometer.
- Do not shift down manually in order to brake.
- Avoid overstraining the vehicle, e.g. by driving at full throttle.
- Do not depress the accelerator pedal past the pressure point (kickdown).
- Increase the engine speed only gradually and accelerate the vehicle to full speed after 1000 miles (1500 km).

This also applies when the engine or parts of the drivetrain have been replaced.

Please also observe the following breaking-in notes:

- In certain handling and driving safety systems, the sensors adjust automatically while a certain distance is being driven after the vehicle has been delivered or after repairs. Full system effectiveness is reached only when this teaching-in process has concluded.
- Brake pads, brake discs and tires that are either new or have been replaced achieve optimum braking effect and grip only after the vehicle has been driven several hundred kilometers. Compensate for the reduced braking effect by applying greater force to the brake pedal.

Notes on driving

⚠ WARNING Risk of accident due to objects in the driver's footwell

Objects in the driver's footwell may impede pedal travel or block a depressed pedal.

This will jeopardize the operating- and road safety of the vehicle.

- ▶ Stow all objects in the vehicle securely so that they cannot get into the driver's footwell.
- ▶ Make sure that there is always sufficient clearance for the pedals.
- ▶ Always install the floor mats securely and as prescribed.
- ▶ Do not use loose floor mats and do not place floor mats on top of one another.

⚠ WARNING Risk of accident due to incorrect footwear

Incorrect footwear includes, for example:

- Shoes with platform soles
- Shoes with high heels
- Slippers

There is a risk of an accident.

- ▶ Always wear suitable footwear so that you can operate the pedals safely.

⚠ WARNING Risk of accident if the vehicle is switched off while driving

If you switch off the vehicle while driving, safety functions are restricted or no longer available.

This may affect the power steering system and the brake force boosting, for example.

You will need to use considerably more force to steer and brake, for example.

- ▶ Do not switch off the vehicle while driving.

⚠ DANGER Risk of death caused by exhaust gases

Combustion engines emit poisonous exhaust gases such as carbon monoxide. Inhaling these exhaust gases is hazardous to health and leads to poisoning.

- ▶ Never leave the engine or, if present, the auxiliary heating running in an enclosed space without sufficient ventilation.

⚠ WARNING Risk of skidding and of an accident due to shifting down on slippery road surfaces

If you shift down on slippery road surfaces to increase the engine braking effect, the drive wheels may lose traction.

- ▶ Do not shift down on slippery road surfaces to increase the engine braking effect.

⚠ DANGER Risk of fatal injury due to poisonous exhaust gases

If the tailpipe is blocked or sufficient ventilation is not possible, poisonous exhaust gases such as carbon monoxide may enter the vehicle. This is the case, for example, if the vehicle gets stuck in the snow.

- ▶ Keep the tailpipe and the area around the vehicle free from snow when the engine or the stationary heater is running.
- ▶ Open a window on the side of the vehicle facing away from the wind to ensure an adequate supply of fresh air.

⚠ WARNING Risk of accident and injury due to being under the influence of alcohol and drugs while driving

Drinking and driving and/or taking drugs and driving are very dangerous combinations. Even a small amount of alcohol or drugs can affect your reflexes, perceptions and judgment.

The possibility of a serious or even fatal accident are greatly increased when you drink or take drugs and drive.

- ▶ Do not drink or take drugs and drive or allow anyone to drive who has been drinking or taking drugs.

⚠ WARNING Risk of accident due to the brake system overheating

If you leave your foot on the brake pedal when driving, the brake system may overheat.

This increases the braking distance and the brake system can even fail.

- ▶ Never use the brake pedal as a footrest.
- ▶ Do not depress the brake pedal and the accelerator pedal at the same time while driving.

! NOTE Engine damage due to excessive engine speed

You will damage the engine if you drive at excessive engine speeds.

- ▶ Do not drive at engine speeds in the red area of the tachometer, or shown in red in the driver display.

! NOTE Wearing out the brake linings by continuously depressing the brake pedal

- ▶ Do not depress the brake pedal continuously whilst driving.
- ▶ To use the braking effect of the engine, shift to a lower gear in good time.

! NOTE Damage to the drivetrain and engine when pulling away

- ▶ Do not warm up the engine while the vehicle is stationary. Pull away immediately.
- ▶ Avoid high engine speeds and driving at full throttle until the engine has reached its operating temperature.

! NOTE Damage to the catalytic converter due to non-combusted fuel

The engine is not running smoothly and is misfiring.

Non-combusted fuel may get into the catalytic converter.

- ▶ Only depress the accelerator pedal slightly.
- ▶ Have the cause rectified immediately at a qualified specialist workshop.

! NOTE Reduced battery life due to frequent short-distance trips

The 12 V battery may not be sufficiently charged when the vehicle is used only for short-distance trips. This reduces the life of the battery.

- ▶ Drive longer distances regularly to charge the battery.

! **NOTE** Vehicle damage due to failure to observe the maximum permissible clearance height

If the vehicle height exceeds the maximum permissible clearance height, the roof and other vehicle parts may be damaged.

- ▶ Please observe the maximum clearance height indicated.
- ▶ If the vehicle exceeds the permissible clearance height, do not drive in.
- ▶ Take the modified vehicle height into account in the case of roof superstructures or other carrier systems.

i Please bear in mind that all speed values stated in this Operator's Manual are approximate and are subject to a certain tolerance.

Observe the notes on driving with a roof load, trailer or fully laden vehicle.

Driving with a loaded roof luggage rack or trailer, or with the vehicle fully laden or occupied, changes the handling and steering characteristics of your vehicle.

Therefore please observe the following notes:

- Do not exceed the permissible roof load and trailer load. Also observe the information in the technical data in this respect.
- Distribute the roof load and vehicle load evenly, and place heavy objects at the bottom. Also comply with the notes on loading the vehicle (→ page 112).
- Drive carefully, avoiding abrupt starting, braking and steering as well as fast cornering.
- If trailer operation is permitted, observe the notes on trailer operation .

Notes on driving on roads treated with de-icing salt

The braking effect is limited on road surfaces treated with de-icing salt.

Please therefore bear in mind the following notes:

- Due to salt build-up on the brake discs and brake linings, the braking distance can increase considerably or braking may be one-sided.

- Maintain a much greater safety distance to the vehicle traveling ahead.

Remove salt build-up as follows:

- Brake occasionally, paying attention to the traffic conditions
- Carefully depress the brake pedal at the end of the journey and when starting the next journey

Notes on hydroplaning

Hydroplaning can take place if a certain depth of water has built up on the road surface.

Observe the following notes during heavy precipitation or in conditions in which hydroplaning may occur:

- Reduce speed.
- Avoid tire ruts.
- Avoid sudden steering movements.
- Brake carefully.

i Also observe the notes on regularly checking wheels and tires (→ page 321).

Notes on driving through water on the road

Water ingress can damage the engine, electrics and transmission.

Water can also enter the air intake of the engine and cause engine damage.

Observe the following if you need to drive through water:

- The water, when calm, should reach no higher than the lower edge of the vehicle body.
- Drive at a walking pace at most, otherwise water may enter the vehicle interior or engine compartment.
- Vehicles traveling ahead, or oncoming vehicles, may create waves that cause the water to exceed the maximum permissible depth.

Braking performance will be reduced after fording. Brake carefully while paying attention to the traffic conditions until braking performance has been fully restored.

ECO start/stop function

ECO start/stop function

- ① Depending on the engine, the ECO start/stop function is not available in all drive programs. Observe the status display on the driver display concerning this.

The engine will be switched off automatically in the following situations if all vehicle conditions for an automatic engine stop are met:

- You brake the vehicle to a standstill in transmission position **D** or **N**.
- **Vehicles with a 48 V on-board electrical system:** you depress the brake pedal when traveling at a low speed.

If the system has detected one of the following situations, the engine will not stop:

- You stop at a stop sign and there is no vehicle in front of you.
- The vehicle that stopped in front of you pulls away again.
- You maneuver, turn the steering wheel sharply or engage reverse gear.





This prevents the engine from stopping briefly.

- ① If the system detects a stop inhibitor to prevent a short stop, e.g. a stop sign, the engine will not stop. If you activate the HOLD function or engage park position **P**, the engine can be switched off in spite of such a stop inhibitor.

The engine will restart automatically in the following cases:

- You engage transmission position **D** or **R**.
- You step on the accelerator pedal.
- The vehicle requires an automatic engine start.
- You release the brake pedal.
- **Vehicles with a 48 V on-board electrical system:**
 - You release the brake pedal on a downhill gradient and the vehicle does not roll.
 - The vehicle rolls on a downhill gradient and does not automatically enter glide mode at 15 mph (20 km/h).

ECO start/stop function symbols on the driver display:

- The  symbol (green) appears when the vehicle is at a standstill: the engine was switched off by the ECO start/stop function.
- The  symbol (yellow) appears when the vehicle is at a standstill: not all vehicle conditions for an engine stop have been met.
- Neither the  nor the  symbol appears when the vehicle is at a standstill: a stop inhibitor to prevent a short stop has been detected, e.g. a stop sign.
- The  symbol appears: the ECO start/stop function is deactivated or there is a malfunction.

If the engine was switched off by the ECO start/stop function and you leave the vehicle, a warning tone will sound and the engine will not be restarted. In addition, the following display message will appear on the driver display:

Vehicle is Ready to Drive Switch Off Vehicle Before Exiting

If you do not switch off the vehicle, it will automatically be switched off after three minutes.

Switching the ECO start/stop function on/off

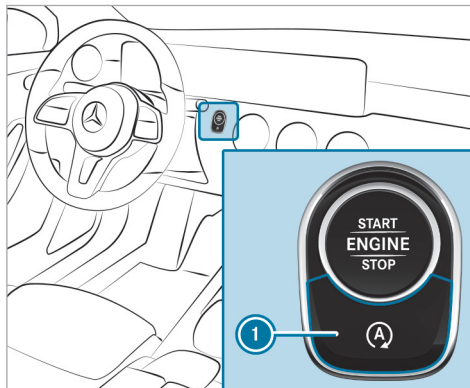

NOTE Mercedes-AMG vehicles

- ▶ Observe the notes in the Supplement. You could otherwise fail to recognize dangers.



- ▶ Press button .

A symbol will appear on the driver display when you switch the ECO start/stop function on/off.

- ▶   will be shown permanently on the driver display while the ECO start/stop function is deactivated.

ECO display function

- ▶  Depending on the model and equipment, your vehicle will have one of the following representations of the ECO display.

The ECO display summarizes your driving characteristics from the start of the journey to its completion and assists you in achieving the most economical driving style.

The ECO display assesses the following criteria for an economical driving style:

- Coasting at the right times
- Consistent speed
- Moderate acceleration

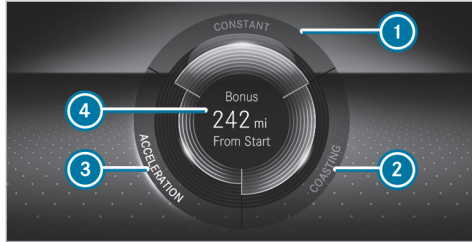

The lettering in the segment will light up brightly, the outer edge will light up and the segment will fill up when the following driving style is adopted:

- ① Steady speed
- ② Gentle deceleration and rolling
- ③ Moderate acceleration

The lettering in the segment will be gray, the outer edge will be dark and the segment will empty when the following driving style is adopted:

- ① Fluctuations in speed
- ② Heavy braking
- ③ Sporty acceleration

The ECO display will show you when you have driven economically:

- The three segments will fill up completely at the same time
- The edge around all three segments will light up

The additional range achieved as a result of your driving style in comparison with a driver with a very sporty driving style will be shown in the center of the display ④. The range displayed does not indicate a fixed reduction in consumption.

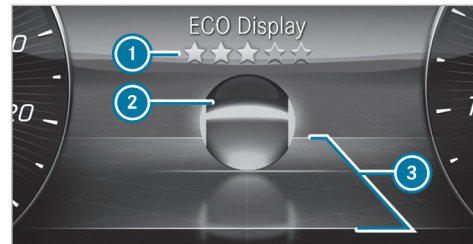

The ECO display shows an evaluation of your driving style on the driver display depending on the

situation. This enables you to check the efficiency of your driving style and adjust it if necessary. The **ECO Display** menu shows a ball ② that will roll forwards or backwards in the direction of travel on a stylized road according to the driving characteristics.

Above and below the road, lines mark the area for an efficient driving style ③. Ball ② will light up in green if it is rolling within these lines. Outside the lines, the ball will light up in orange.

The overall assessment of your driving style "from start" is indicated using stars ①. It starts with five empty stars, which you can fill one after the other if you drive efficiently. When all five stars are filled, a glow will appear in the background.

- ① You can call up the **ECO Display** function via the **Classic** menu (→ page 229).

ECO Assist function (vehicles with 48 V on-board electrical system)

- ① ECO Assist is active only in drive programs **[E]** and **[C]**.

ECO Assist analyzes data for the vehicle's expected route. This allows the system to optimally adjust the driving style for the route ahead, save fuel and recuperate. If the system detects an event ahead and the vehicle nears the event, ECO Assist will calculate the optimum speed for maximum fuel economy and recuperative energy based on the distance, speed and downhill gradient.

If the deceleration provided by ECO Assist is not sufficient, you must also brake with the service brake. This is especially the case if, for example, you pull away again in slow-moving traffic and the distance to the vehicle in front is very short.

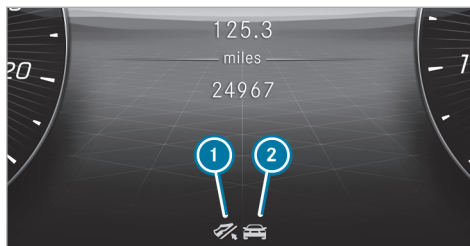

- ① "Foot off the accelerator" recommendation
- ② Route event ahead





If a route event ahead or a vehicle driving in front is detected which requires an adjustment to your driving style to ensure greater efficiency, corresponding symbol ② and the  symbol will be displayed in gray.



If you release the accelerator pedal, the  symbol will turn green and recuperation in overrun mode will be initiated. If the deceleration is not sufficient, also apply the service brake. If ECO Assist intervenes for a route event ahead (not for a vehicle in front) and you then press the accelerator pedal again, you end ECO Assist's control.

The ECO Assist display is hidden again in the following cases:

- You do not react to the ECO Assist recommendation for a long time.
- You press the accelerator pedal while ECO Assist is intervening for a route event ahead (not for a vehicle in front).
- ECO Assist cannot identify any further recommendations from the route ahead.

Depending on the equipment, in addition to the  vehicle driving ahead, ECO Assist detects following route events ②:

-  Traffic circle
-  T-intersection
-  Downhill gradient
-  Speed limit

- ① In the  drive program, ECO Assist only reacts to the route event "Vehicle in front" without a display of the  route event and the  recommendation.

System limits

If the calculated route is adhered to when route guidance is active, ECO Assist will operate with greater accuracy. The basic function is also available without active route guidance. Not all information and traffic situations can be foreseen. The quality depends on the map data.

ECO Assist is only an aid. The driver is responsible for keeping a safe distance from the vehicle in front, for vehicle speed and for braking in good time.

The system may be impaired or may not function in the following situations:

- If there is poor visibility, e.g. due to insufficient illumination of the road, highly variable shade conditions, rain, snow, fog or heavy spray.
- If there is glare, e.g. from oncoming traffic, direct sunlight or reflections.
- If the windshield is dirty in the vicinity of the multifunction camera.
- If the multifunction camera is fogged up, damaged or obscured.

- If road signs are hard to detect, e.g. due to dirt, snow or insufficient lighting, or because they are obscured.
- If the information in the navigation system's digital map is incorrect or out of date.
- If signs are ambiguous, e.g. road signs in roadworks or in adjacent lanes.
- If the radar sensors are dirty or obscured.
- When you drive on roads with steep uphill or downhill gradients.
- If there are narrow vehicles in front, such as bicycles or motorcycles.

DYNAMIC SELECT

Function of DYNAMIC SELECT

NOTE Mercedes-AMG vehicles

- ▶ Observe the notes in the Supplement. You could otherwise fail to recognize dangers.

DYNAMIC SELECT allows a drive program to be selected quickly according to the current driving conditions or the desired vehicle characteristics. You will be able to select the following drive programs.

-  Depending on the engine line-up and equipment, the vehicle will have different drive programs.

The drive program selected will appear on the driver display.

Individual

- Custom settings (→ page 154)

Sport

- Maximum output is available
- Sporty driving
- Sporty, but with an emphasis on stability
- Enables a sporty driver to adopt a more active driving style
- Suitable only for good road conditions, a dry surface and a clear stretch of road

C Comfort

- Comfortable and economical driving
- Balance between traction and stability
- Recommended for all road conditions

E Eco

- Particularly economical driving
- Balance between traction and stability
- Recommended for all road conditions

i The ESP® settings in drive programs **E** and **C** are designed for stability. Therefore, choose one of these drive programs especially when transporting roof loads, in trailer operation and when the vehicle is fully laden or fully occupied.

Depending on the drive program, the following systems will change their characteristics:

- Drive
 - Engine and transmission management
 - Active Distance Assist DISTRONIC
 - Availability of Glide mode

- ESP®
- **Vehicles with adaptive damping adjustment:** suspension
- Steering

Selecting the drive program

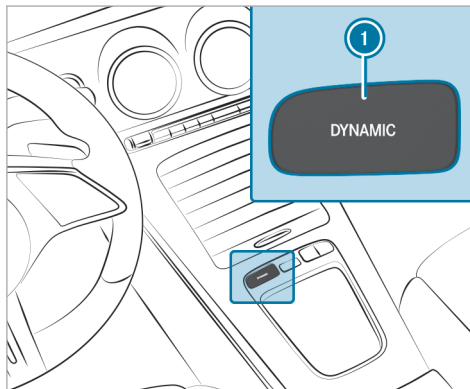

▶ Press DYNAMIC SELECT button **1** repeatedly until the selected drive program appears on the driver display.

or

▶ Press DYNAMIC SELECT button **1** and select the drive program in the DYNAMIC SELECT menu on the central display.

Configuring DYNAMIC SELECT in the multimedia system

Multimedia system:

▶ ▶ Settings ▶ Vehicle ▶ DYNAMIC SELECT

Setting the I drive program

▶ Select **I** Individual.

▶ Select .

▶ Select a category from the list and set it.

i A sporty ESP mode can be set in conjunction with a sporty suspension mode.

Switching the reset display on/off

▶ Activate or deactivate **Request at Start**.

ⓘ This function must be activated for each user profile separately. Only when this function is activated will the drive program and ECO start/stop setting for the previous journey be saved for the respective user profile.

Function on: the next time the vehicle is started a prompt appears asking whether the last active drive program should be restored. If the ECO start/stop function was deactivated, an additional prompt appears asking if the function should remain deactivated.

ⓘ The prompt appears only if the previously active settings deviate from the standard settings.

Function off: the next time the vehicle is started the **[C]** drive program is set automatically. The ECO start/stop function is activated automatically.

Displaying vehicle data

Multimedia system:



▶ Select **Vehicle**.
The vehicle data is displayed.

Displaying engine data

Multimedia system:



▶ Select **Engine**.
The engine data is displayed.

ⓘ The actual maximum values that can be achieved for engine output and engine torque may deviate from the certified values within the country-specific guidelines for permissible tolerances (basis: UN-ECE No. 85 or country-specific guidelines).

Influencing variables include:

- Sea level
- Fuel quality
- Outside temperature

- Operating temperature of the engine

Adjust your driving style accordingly. The  warning lamp in the driver display is on until the engine has reached operating temperature.

- ⓘ The values displayed serve only as guidance. The values for engine output and engine torque shown in the media display may deviate from the actual values.
- ⓘ The  warning lamp to show the power output limitation after starting the vehicle is not available in all vehicle models.

Calling up the fuel consumption indicator

Multimedia system:



▶ Select **Consumption**.
The current and average fuel consumption will be displayed.

Automatic transmission

DIRECT SELECT lever

Function of the DIRECT SELECT lever

⚠ WARNING Risk of accident due to incorrect gearshifting

If the engine speed is higher than the idle speed and you engage the transmission position **D** or **R**, the vehicle may accelerate sharply.

- ▶ If you engage the transmission position **D** or **R** when the vehicle is at a standstill, always depress the brake pedal firmly and do not accelerate at the same time.

⚠ WARNING Risk of accident and injury due to children left unattended in the vehicle

If you leave children unattended in the vehicle, they could, in particular:

- open doors, thereby endangering other persons or road users.
- get out and be struck by oncoming traffic.
- operate vehicle equipment and become trapped, for example.

In addition, the children could also set the vehicle in motion by, for example:

- releasing the parking brake.
- changing the gearbox position.
- starting the vehicle.
- ▶ Never leave children unattended in the vehicle.
- ▶ When leaving the vehicle, always take the key with you and lock the vehicle.
- ▶ Keep the key out of reach of children.

⚠ WARNING Risk of accident- and injury when the transmission position is not engaged

The current transmission position will be highlighted on the driver display.

If the selected transmission position is not highlighted, the vehicle may pull away in the wrong direction or roll away.

- ▶ After changing the transmission position, always check the transmission position indicator on the driver display.

If the transmission position is not highlighted on the driver display even after a short time:

- ▶ Pay attention to the display messages.
- ▶ Pull away carefully and check the engaged transmission position.
- ▶ When parking, engage the parking brake and secure the vehicle against rolling away.
- ▶ Have the transmission checked immediately at a qualified specialist workshop.

Use the DIRECT SELECT lever to switch the transmission position. The current transmission position will be highlighted on the driver display.

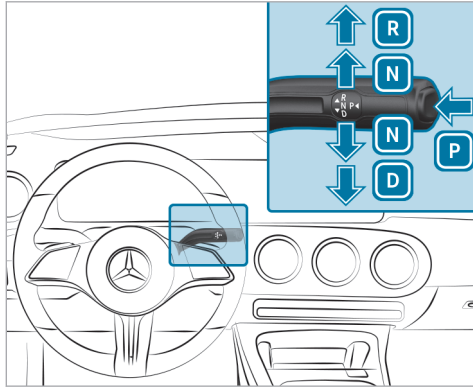

- P** Park position
- R** Reverse gear
- N** Neutral
- D** Drive position

Engaging reverse gear R

- ▶ Depress the brake pedal and push the DIRECT SELECT lever upwards past the first point of resistance.

Engaging neutral N

- ▶ Depress the brake pedal and push the DIRECT SELECT lever up or down to the first point of resistance.
- ⓘ To shift into neutral **N** with the vehicle switched on, push the selector lever up or down for several seconds to the first point of resistance.

Subsequently releasing the brake pedal will allow you to move the vehicle freely, e.g. to push it or tow it away.

Proceed as follows if you want the automatic transmission to remain in neutral **N, even if the vehicle is switched off or the driver's door is opened:**

- ▶ Depress the brake pedal and engage neutral **N** when the vehicle is at a standstill.
- ▶ Release the brake pedal.

- ▶ Switch off the vehicle.

The **Risk of Vehicle Rolling Away N Activated Manually No Automatic Change to P** message appears on the driver display.

- ⓘ If you then exit the vehicle leaving the key in the vehicle, the automatic transmission will remain in neutral **N**.

Park position **P** will automatically be re-engaged as soon as one of the following conditions is met:

- You switch to transmission position **D** or **R**.
- You press the button **P**.

Engaging park position P

! **NOTE** Damage due to engaging park position **P** while the vehicle is rolling

If you shift the transmission into park position **P** while the vehicle is rolling, the transmission may be damaged.

- ▶ If the vehicle is rolling, do not open a door.

▶ Only engage park position **P** when the vehicle is stationary.

▶ Observe the notes on parking the vehicle (→ page 164).

▶ Depress the brake pedal until the vehicle comes to a standstill.

▶ When the vehicle is stationary, press button **P**.

When the **P** transmission position display is shown, park position is engaged. If the **P** transmission position display is not shown, apply the parking brake and secure the vehicle to prevent it from rolling away.

i Depending on the situation, it may take a short time until **P** is engaged. Therefore, always pay attention to the transmission position display.

Park position **P** will be engaged automatically if one of the following conditions is met:

- You switch the stationary vehicle off in transmission position **D** or **R**.

- You open the driver's door when the vehicle is stationary in transmission position **D** or **R**.
- When the vehicle is rolling, you switch it off in transmission position **D** or **R** and bring it to a standstill.
- When the vehicle is rolling, you shift to transmission position **N**, bring the vehicle to a standstill and open the driver's door when the vehicle is stationary.
- Engaging park position **P** automatically is required by the vehicle.

i To maneuver with the driver's door open, open the driver's door while the vehicle is stationary and engage transmission position **D** or **R** again.

i At very low outside temperatures below approximately -4°F (-20°C), it may not be possible to shift the transmission from **P** to another transmission position when the vehicle is switched off. If this is the case, change the transmission position only while the vehicle is switched on.

Engaging drive position D

▶ Depress the brake pedal and push the DIRECT SELECT lever down past the first point of resistance.

When the automatic transmission is in transmission position **D**, it will shift gears automatically. This depends, among other things, on the following factors:

- The selected drive program
- The position of the accelerator pedal
- The vehicle speed

Problems with the transmission

The transmission is experiencing gearshift problems

Possible cause:

- The transmission is losing oil.
- ▶ Have the transmission checked at a qualified specialist workshop immediately.

The acceleration characteristics are getting worse and the transmission is no longer shifting.

Possible cause:

- The transmission is in emergency operation mode.
- ▶ Stop the vehicle as the traffic conditions permit.
 - ▶ Shift the transmission to position **P**.
 - ▶ Switch off the vehicle.
 - ▶ Wait at least ten seconds.
 - ▶ Restart the vehicle.
 - ▶ Shift the transmission to position **D**.
 - ▶ Have the transmission checked at a qualified specialist workshop immediately.

Manual gear shifting

! NOTE Mercedes-AMG vehicles

- ▶ Observe the notes in the Supplement. You could otherwise fail to recognize dangers.

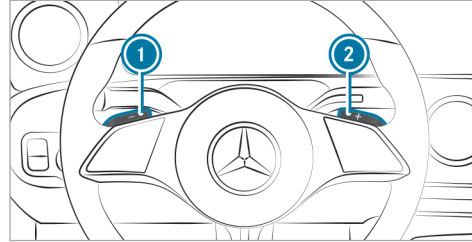

When the automatic transmission is set to position **D**, you can shift it manually using the steering wheel paddle shifters. If permitted, the automatic transmission will shift to a higher or lower gear depending on the steering wheel paddle shifter pulled.

You have two options for manually shifting the automatic transmission:

- Temporary setting
- Permanent setting

The gears are shifted automatically when manual gear shifting is deactivated.

Temporary setting:

- ▶ **To activate:** pull steering wheel paddle shifter **1** or **2**.
Manual gear shifting will be activated for a short time. The transmission position display will show **M** and the current gear.

- ▶ **i** How long manual gear shifting stays activated depends on various factors.

Manual gear shifting can be deactivated automatically in the following cases:

- When the drive program is changed
- When the vehicle is restarted
- When transmission position **D** is engaged again
- Driving style

- ▶ **To shift up:** pull steering wheel paddle shifter **2**.

- ▶ **To shift down:** pull steering wheel paddle shifter **1**.
If you pull and hold steering wheel paddle shifter **1**, the transmission will shift down to the lowest possible gear.

▶ **To deactivate:** pull and hold steering wheel paddle shifter ②.

The transmission position display will show **D**.

① You can activate or deactivate manual gear shifting permanently in the multimedia system.

Permanently activate/deactivate manual gear-shifting

Multimedia system:

→  ▶ Settings ▶ Vehicle ▶ Driving

▶ Permanently activate or deactivate the function.

Gearshift recommendation

The gearshift recommendation assists you in adopting an economical driving style.



▶ If gearshift recommendation ① appears next to the transmission position display, shift to the recommended gear.

Using kickdown

▶ **Maximum acceleration:** depress the accelerator pedal beyond the point of resistance.

To protect against engine overrev, the automatic transmission will shift up to the next gear when maximum engine speed has been reached.

Glide mode function

! **NOTE** Mercedes-AMG vehicles

▶ Observe the notes in the Supplement. You could otherwise fail to recognize dangers.

Glide mode helps you to reduce fuel consumption when you employ an anticipatory driving style.

Glide mode is characterized by the following:

- The internal-combustion engine is disconnected from the drivetrain and continues to run in neutral.
- The transmission position display **D** is shown in green.
- **Vehicles with 48 V on-board electrical system:** the internal-combustion engine is switched off depending on the driving situation. All the vehicle functions remain active.

Glide mode is activated if the following conditions are met:

- Drive program **E** is selected.

- The speed is within a suitable range.
- The road's course is suitable, e.g. no steep inclines or tight bends.
- The state of charge of the battery is sufficient.
- You do not depress the accelerator or brake pedal (except for light brake applications).

i Glide mode can also be activated if you have selected the "Eco" setting for the drive in the drive program .

Glide mode will be deactivated again if one of the conditions is no longer met.

Vehicles with Active Distance Assist DISTRONIC: when Active Distance Assist DISTRONIC is active, glide mode is not available.

Glide mode can also be prevented by the following parameters:

- Incline
 - Downhill gradient
 - Temperature
 - Altitude
 - Speed
- Operating condition of the engine
 - Traffic situation
- i** You can end glide mode by operating a steering wheel paddle shifter (→ page 159).

Function of 4MATIC

4MATIC ensures that all four wheels are driven. Together with ESP® and 4ETS, 4MATIC improves the traction of your vehicle whenever a driven wheel spins due to insufficient traction.

If you fail to adapt your driving style, 4MATIC can neither reduce the risk of an accident nor override the laws of physics. 4MATIC cannot take account of road, weather and traffic conditions. 4MATIC is only an aid. You are responsible in particular for maintaining a safe distance from the vehicle in front, for vehicle speed, for braking in good time and for staying in lane.

i In wintry road conditions, the maximum effect of 4MATIC can be achieved only if you use winter tires (M+S tires), with snow chains if necessary.

Refueling

Refueling the vehicle

⚠ WARNING Risk of fire or explosion from fuel

Fuels are highly flammable.

- ▶ Fire, open flames, smoking and creating sparks must be avoided.
- ▶ Before refueling, switch off the vehicle and, if installed, the stationary heater, and leave them switched off during refueling.

⚠ WARNING Risk of injury from fuels

Fuels are poisonous and hazardous to your health.

- ▶ Do not swallow fuel or let it come into contact with skin, eyes or clothing.
- ▶ Do not inhale fuel vapor.
- ▶ Keep children away from fuel.

- ▶ Keep doors and windows closed during the refueling process.

If you or other people come into contact with fuel, observe the following:

- ▶ Immediately rinse fuel off your skin with soap and water.
- ▶ If fuel comes into contact with your eyes, immediately rinse them thoroughly with clean water. Seek medical attention immediately.
- ▶ If you swallow fuel, seek medical attention immediately. Do not induce vomiting.
- ▶ Change immediately out of clothing that has come into contact with fuel.

⚠ WARNING Risk of fire and explosion due to electrostatic charge

Electrostatic charge can ignite fuel vapor.

- ▶ Before you open the fuel filler cap or take hold of the pump nozzle, touch the metallic vehicle body.
- ▶ To avoid creating another electrostatic charge, do not get into the vehicle again during the refueling process.

! NOTE Damage caused by the wrong fuel

Vehicles with a gasoline engine:

Even small amounts of the wrong fuel could result in damage to the fuel system, the engine and the emission control system.

- ▶ Refuel only with low-sulfur spark-ignition engine fuel.

This fuel may contain up to 10% ethanol. Your vehicle is suitable for use with E10 fuel.

Never refuel with any of the following fuels:

- Diesel
- Gasoline with more than 10% ethanol by volume, e.g. E15, E85, E100

- Gasoline with more than 3% methanol by volume, e.g. M15, M30, M85, M100
- Gasoline with metallic additives

If you have accidentally refueled with the wrong fuel:

- ▶ Do not switch on the vehicle.
- ▶ Consult a qualified specialist workshop.

! NOTE Do not use diesel to refuel vehicles with a gasoline engine

If you have accidentally refueled with the wrong fuel:

- Do not switch on the vehicle. Otherwise fuel can enter the engine.
Even small amounts of the wrong fuel could result in damage to the fuel system and the engine. The repair costs are high.
- ▶ Consult a qualified specialist workshop.
- ▶ Have the fuel tank and fuel lines drained completely.

! **NOTE** Damage to the fuel system due to overfilling the fuel tank

▶ Only fill the fuel tank until the pump nozzle switches off.

If too much fuel has been added due, for example, to a faulty filling pump:

- ▶ Do not switch on the vehicle.
- ▶ Consult a qualified specialist workshop.

! **NOTE** Fuel may spray out when you remove the fuel pump nozzle

▶ Only fill the fuel tank until the pump nozzle switches off.

Requirements:

- The vehicle is unlocked.

Observe the notes on operating fluids and fuel.

Only refuel with fuel that has at least the octane number specified in the information label on the inside of the fuel filler flap. Otherwise engine out-

put may be reduced and fuel consumption increased.

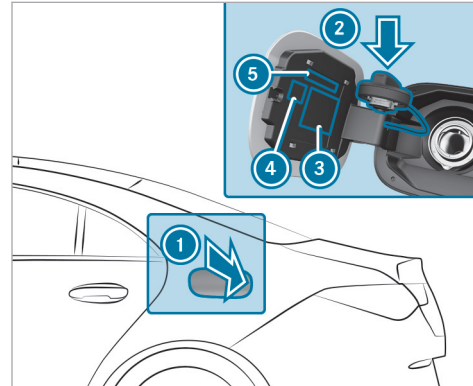

- ① Fuel filler flap
- ② Bracket for the fuel filler cap
- ③ Tire pressure table
- ④ QR code for rescue card
- ⑤ Fuel type

- ▶ Press on the center rear of the fuel filler flap ①.
- ▶ Turn the fuel filler cap counter-clockwise and remove it.
- ▶ Insert the fuel filler cap from above into bracket ②.
- ▶ Completely insert the pump nozzle into the tank filler neck, hook in place and refuel.
- ▶ Fill the fuel tank only until the pump nozzle switches off.
- ▶ Replace the fuel filler cap on the tank filler neck and turn clockwise until it engages audibly.
- ▶ Close fuel filler flap ①.

Parking

Parking the vehicle

- ⚠ WARNING** Risk of accident and injury caused by an insufficiently secured vehicle rolling away

If the vehicle is not securely parked sufficiently, it can roll away in an uncontrolled way even at a slight downhill gradient.

- ▶ On uphill or downhill gradients, turn the front wheels so that the vehicle rolls towards the curb if it starts moving.
- ▶ Apply the parking brake.
- ▶ Switch the transmission to position **P**.

- ⚠ WARNING** Risk of fire caused by hot exhaust system parts

Flammable materials such as leaves, grass or twigs may ignite.

- ▶ Park the vehicle so that no flammable material can come into contact with hot vehicle components.

- ▶ In particular, do not park on dry grass-land or harvested grain fields.

- ⚠ WARNING** Risk of accident and injury due to children left unattended in the vehicle

If you leave children unattended in the vehicle, they could, in particular:

- open doors, thereby endangering other persons or road users.
- get out and be struck by oncoming traffic.
- operate vehicle equipment and become trapped, for example.

In addition, the children could also set the vehicle in motion by, for example:

- releasing the parking brake.
- changing the gearbox position.
- starting the vehicle.

- ▶ Never leave children unattended in the vehicle.

- ▶ When leaving the vehicle, always take the key with you and lock the vehicle.
- ▶ Keep the key out of reach of children.

- !** **NOTE** Damage to the vehicle due to it rolling away

- ▶ Always secure the vehicle against rolling away.

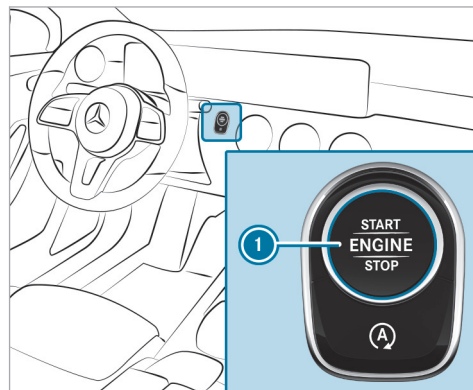

- ▶ Bring the vehicle to a standstill by depressing the brake pedal.
- ▶ On inclines, turn the front wheels so that the vehicle will roll towards the curb if it starts moving.
- ▶ Apply the electric parking brake.
- ▶ Engage transmission position **P** when the vehicle is stationary and the brake pedal is depressed (→ page 157).
- ▶ Switch off the vehicle by pressing button **i**.
- ▶ Release the service brake slowly.
- ▶ Get out of the vehicle and lock it.

i When you park the vehicle, you can still operate the side windows and the panoramic sliding sunroof for approximately four minutes if the driver's door is closed.

Automatic vehicle shut-off upon locking

Your vehicle is equipped with automatic engine shut-off.

When you leave the vehicle ready to drive, the vehicle will be turned off when locked under the following conditions:

- The ignition is switched on or the engine is running.
- Transmission position **P** is engaged.
- The driver's door is closed.
- **In addition, one of the following conditions must be fulfilled:**
 - The vehicle is locked using the vehicle key.
 - **Vehicles with KEYLESS-GO:** the vehicle is locked via KEYLESS-GO on the door handle of a closed door.
 - **Vehicles with KEYLESS-GO:** the vehicle is locked via the locking button on the trunk lid.

i The engine will continue to run if the vehicle is not locked as described after you have left it. In this case, switch off the vehicle manually.

Automatic vehicle shut-off after a period of time (equipment-dependent)

When the engine is running, the following display message will appear on the driver display when you leave the vehicle or after a certain holding time in transmission position **P**: **Vehicle Ready to Drive Shutdown Occurs When Locked or Automatically in XX Mins**

The vehicle will then switch off automatically after a total holding time of 20 minutes.

i To avoid automatic shut-off after a period of time, acknowledge the corresponding message on the central display of the multimedia system.

The engine will continue to run in the following cases:

- If the vehicle is not locked as described after you have left it
- If automatic shut-off is not indicated by the display message
- If automatic shut-off after a period of time has been deactivated via the corresponding message on the central display

In this case, switch off the vehicle manually.

Garage door opener

■ Programming buttons for the garage door opener

⚠ DANGER Risk of death caused by exhaust gases

Combustion engines emit poisonous exhaust gases such as carbon monoxide. Inhaling these exhaust gases is hazardous to health and leads to poisoning.

▶ Never leave the engine or, if present, the auxiliary heating running in an enclosed space without sufficient ventilation.

⚠ WARNING Risk of injury by becoming trapped when opening and closing a garage door

When you operate or program a garage door with an integrated garage door opener, persons can become trapped or struck by the garage door if they stand within its range of movement.

▶ Always make sure that nobody is within the range of the garage door's movement.

Operate only the following doors using the garage door opener:

- Doors with a safety stop and reversing function
- Doors that conform to the current US safety standards

Before programming the garage door opener, park the vehicle outside the garage. Make sure that the vehicle is switched on but not started.

Requirements

- The vehicle has been parked outside the garage or outside the range of movement of the door.
 - The vehicle is switched on.
 - The vehicle has not been started.
- ⓘ The garage door opener function will always be available when the vehicle is switched on.

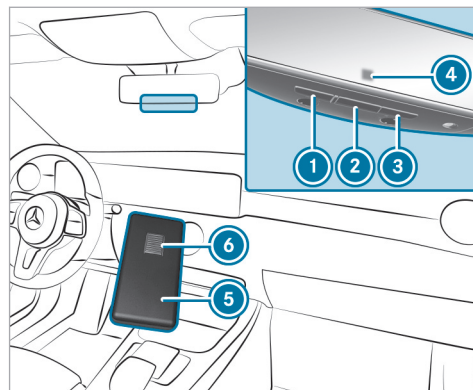

▶ Check whether the transmitter frequency of the remote control has the frequency range of 280 to 868 MHz.

Radio equipment approval number:

- NZLMUAHL5 (USA)
- 4112A-MUAHL5 (Canada)

- ▶ Press and hold button ①, ② or ③ that you wish to program. Indicator lamp ④ will flash yellow.
- ① It may take up to 20 seconds before the indicator lamp flashes yellow.
- ▶ Release the previously pressed button. Indicator lamp ④ will continue to flash yellow.
- ▶ Point the remote control ⑤ from a distance of between 0.4 in (1 cm) and 3 in (8 cm) towards button ①, ② or ③.
- ▶ Press and hold button ⑥ of remote control ⑤ until one of the following signals appears:
 - Indicator lamp ④ lights up green continuously. Programming is complete.
 - Indicator lamp ④ flashes green. Programming was successful. Additionally, the rolling code must be synchronized with the door system.
- ▶ If indicator lamp ④ does not light up or flash green: repeat the process.
- ▶ Release all the buttons.

- ① The remote control for the door drive is not included in the scope of delivery for the garage door opener.

■ Synchronizing the rolling code

Requirements

- The door system uses a rolling code.
- The vehicle must be within range of the garage door or door drive.
- The vehicle, as well as persons and objects are located outside the range of movement of the door.
- ▶ Press the programming button on the door drive unit. Initiate the next step within approximately 30 seconds.
- ▶ Press the previously programmed button ①, ② or ③ repeatedly until the door closes. When the door closes, programming is completed.
- ① Please also read the operating instructions for the door drive.

■ Troubleshooting during programming of the remote control

- ▶ Check whether the transmitter frequency of the remote control ⑤ is supported.
- ▶ Replace the batteries in the remote control ⑤.
- ▶ Hold the remote control ⑤ at various angles in front of the inside mirror from a distance of between 0.4 in (1 cm) and 3 in (8 cm). You should test every position for at least 25 seconds before trying another position.
- ▶ Hold remote control ⑤ at the same angles at various distances in front of the inside mirror. You should test every position for at least 25 seconds before trying another position.
- ▶ Press the button ⑥ on the remote control ⑤ again before transmission ends on remote controls that transmit only for a limited period.
- ▶ Angle the antenna line of the garage door opener unit towards the remote control.

- ❗ It is possible that older garage doors cannot be operated using the remote control in the inside mirror, even after you have successfully performed the measures described above. In this case, contact the HomeLink® Hotline.
- ❗ Support and additional programming information:
 - from the toll-free HomeLink® Hotline on 1-800-355-3515
 - online at <https://www.homelink.com/mercedes>

■ Opening or closing the garage door

Requirements

- The corresponding button is programmed to operate the door.
- ▶ Press and hold buttons ❶, ❷ or ❸ until the door opens or closes.
- ▶ If the indicator lamp ❹ flashes yellow after approx. 20 seconds: Press the previously pressed button again and hold pressed until the door opens or closes.

■ Clearing the garage door opener memory

- ▶ Press and hold buttons ❶ and ❸. Indicator lamp ❹ lights up yellow.
- ▶ If indicator lamp ❹ flashes green: release buttons ❶ and ❸. The entire memory has been deleted.

Electric parking brake

■ Function of the electric parking brake (applying automatically)

⚠ WARNING Risk of accident and injury due to children left unattended in the vehicle

If you leave children unattended in the vehicle, they could, in particular:

- open doors, thereby endangering other persons or road users.
- get out and be struck by oncoming traffic.
- operate vehicle equipment and become trapped, for example.

In addition, the children could also set the vehicle in motion by, for example:

- releasing the parking brake.
 - changing the gearbox position.
 - starting the vehicle.
- ▶ Never leave children unattended in the vehicle.
 - ▶ When leaving the vehicle, always take the key with you and lock the vehicle.
 - ▶ Keep the key out of reach of children.

The electric parking brake is applied if the transmission is in position **P** and one of the following conditions is fulfilled:

- The vehicle is switched off.
 - The driver's seat belt is not fastened and the driver's door is opened.
- ❗ To prevent application: pull the handle of the electric parking brake (→ page 170).

In the following situations, the electric parking brake is also applied:

- The HOLD function is keeping the vehicle stationary.
- Active Distance Assist DISTRONIC is bringing the vehicle to a standstill.
- Active Parking Assist is keeping the vehicle stationary.
- **In addition, one of the following conditions must be fulfilled:**
 - The vehicle is switched off.
 - The driver's seat belt is not fastened.
 - There is a system malfunction.
 - The power supply is insufficient.
 - The vehicle is stationary for a lengthy period.
- **Vehicles with Active Parking Assist:** In the following situations, the electric parking brake is also engaged:
 - Following completion of a parking procedure.

- If an error occurs during a parking procedure.

When the electric parking brake is applied, the red indicator lamp lights up in the driver display **PARK** (USA) or **(P)** (Canada).

- ⓘ The electric parking brake is not automatically applied if the vehicle is switched off by the ECO start/stop function.

■ Function of the electric parking brake (automatic release)

The electric parking brake is released when the following conditions are fulfilled:

- The driver's door is closed.
- The vehicle has been started.
- The transmission is in position **D** or **R** and you step on the accelerator pedal, or you shift from transmission position **P** to **D** or **R** on level ground.
- If the transmission is in position **R**, the trunk lid must be closed.
- The driver's seat belt is not properly fastened.

If the driver's seat belt is not fastened, the following condition must be met:

- You shift from transmission position **P**.

When the electric parking brake is released, the red **PARK** (USA) or **(P)** (Canada) indicator lamp in the driver display goes out.

■ Applying/releasing the electric parking brake manually

Apply

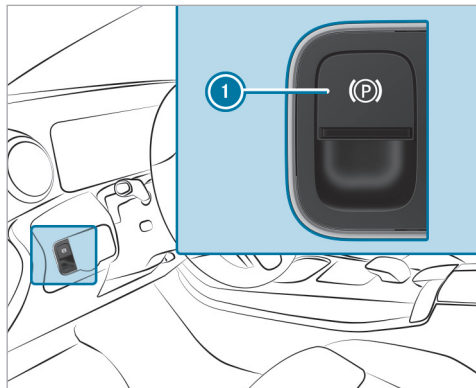

- ▶ Push handle ①.
The red indicator lamp lights up on the driver display **PARK** (USA) or **(P)** (Canada).

- ① The electric parking brake is only securely applied if the red **PARK** (USA) or **(P)** (Canada) indicator lamp is lit continuously.

Release

- ▶ Switch on the vehicle.
- ▶ Pull handle ①.
The red indicator lamp on the driver display goes out **PARK** (USA) or **(P)** (Canada).

■ Emergency braking

- ▶ Press and hold handle ①.
As long as the vehicle is in motion, the **Release Parking Brake** message is displayed and the red indicator lamp **PARK** (USA) or **(P)** (Canada) flashes.

When the vehicle has been braked to a standstill, the electric parking brake is applied. The red indicator lamp **PARK** (USA) or **(P)** (Canada) lights up on the driver display.

Information on collision detection for a parked vehicle

Suppose a collision is detected on the locked vehicle when the tow-away alarm is switched on, and collision detection is switched on. In that case, when the vehicle is switched on, you will receive a message in the multimedia system.

You will receive information about the following points:

- The area of the vehicle that may have been damaged.
- The force of the impact.

The following situation can lead to inadvertent activation:

- For example, the parked vehicle is moved to a two-story garage.
- ① Deactivate the tow-away alarm to prevent inadvertent activation. If you deactivate the tow-away alarm, collision detection will also be deactivated.

You can permanently deactivate collision detection via the multimedia system (→ page 171).

- ❗ If the battery is heavily discharged, the function for detecting a collision on a parked vehicle is automatically deactivated to facilitate the next engine start.

System limits

Detection may be restricted in the following situations:

- the vehicle is damaged without impact, for example, if an outside mirror is torn off or the paint is damaged by a key
 - an impact occurs at low speed
 - the electric parking brake is not applied
- ❗ You are responsible for your vehicle. Convince yourself that your vehicle is free of damage and roadworthy.

Setting collision detection for a parked vehicle

Multimedia system:

→  **Settings** **▶▶ Vehicle**
▶▶ Open/Close **▶▶ Vehicle Protection**

- ▶ Activate or deactivate the function via **Collision Notification**.
- ❗ A maximum of three incidents can be registered. Up to 15 photos are taken for every incident. In the event of another incident, the photos of the first incident will be overwritten if they have not been deleted already.

Activating or deactivating the collision photos function

Please note that legal restrictions regarding automatic recording of the vehicle surroundings may be in place in certain countries.

- ▶ Activate or deactivate **Collision Photos**.

Transferring the collision photos with the Mercedes me app

- ▶ Select **Upload Collision Photos**.
- or

- ▶ Select **Upload Automatically**.

- ❗ Any device that can scan QR codes can be used to view the collision photos in the Mercedes me app.

Copying the collision photos to a USB flash drive

- ▶ Connect a USB flash drive.
- ▶ Select **Manage Collision Photos**.
- ▶ Select **Copy (USB)**.
All collision photos are copied to the USB flash drive.
- ❗ Only use FAT32 or exFAT formatted USB storage devices to ensure secure operation.

Deleting collision photos

- ▶ Select **Manage Collision Photos**.
- ▶ Select **Delete**.
All collision photos are deleted.

Notes on parking up the vehicle

If you leave the vehicle parked up for longer than six weeks, it may suffer damage through disuse.

172 Driving and parking

The 12 V battery may also be impaired or damaged by heavy discharging.

Do not disconnect the 12 V battery even if the vehicle is left idle for a lengthy period.

- ① Further information can be obtained at a qualified specialist workshop.

Standby mode (extension of the starter battery's period out of use)

Standby mode function

① This function is not available for all models. If standby mode is activated, energy loss will be minimized during extended idle times.

Standby mode is characterized by the following:

- The starter battery is preserved.
- The maximum idle time appears on the driver display.
- The connection to online services is interrupted.
- The ATA (anti-theft alarm system) is not available.

- The interior protection and tow-away alarm functions are not available.
- The function for detecting collisions when the vehicle is parked is not available.

If the following conditions are fulfilled, standby mode can be activated or deactivated using the multimedia system:

- The vehicle is switched on.
- The vehicle has not been started.

Exceeding the vehicle's displayed idle time may cause inconvenience; i.e. it cannot be guaranteed that the starter battery will reliably start the vehicle.

Charge the starter battery in the following situations:

- If the vehicle's idle time needs to be extended.
- If the starter battery state of charge is insufficient for standby mode.

① Standby mode is automatically deactivated when the vehicle is switched on.

Activating/deactivating standby mode (parking up the vehicle)

Requirements

- The vehicle is switched on.
- The vehicle has not been started.

Multimedia system:

→  » Settings » Vehicle

» Other Functions

▶ Activate or deactivate Standby Mode.

Driving and driving safety systems

Driving systems and your responsibility

Your vehicle is equipped with driving systems that assist you in driving, parking and maneuvering the vehicle. The driving systems are only aids. They are not a substitute for you paying attention to your surroundings and do not relieve you of your responsibility pertaining to road traffic law. The driver is always responsible for maintaining a safe distance to the vehicle in front, for vehicle speed, for braking in good time and for staying in lane.

Pay attention to the traffic conditions at all times and intervene when necessary. Be aware of the limitations regarding the safe use of these systems.

Driving systems can neither reduce the risk of an accident if you fail to adapt your driving style nor override the laws of physics. They cannot always take into account road, weather or traffic conditions.

- ① Some driving systems can regulate or limit the speed to a previously set value. Draw attention to the stored speed when changing drivers.

Information on vehicle sensors and cameras

Some driving and driving safety systems use cameras as well as radar or ultrasonic sensors to monitor the area in front of, behind or next to the vehicle.

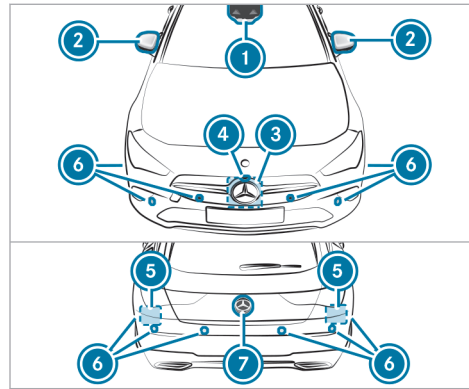

- ① Multifunction camera
- ② Cameras in the exterior mirrors
- ③ Front radar
- ④ Front camera
- ⑤ Corner radars
- ⑥ Ultrasonic sensors
- ⑦ Rear-view camera

⚠ WARNING Risk of accident due to restricted detection performance of vehicle sensors and cameras

If the area around vehicle sensors or cameras is covered, damaged or dirty, certain driving and safety systems cannot function correctly. There is a risk of an accident.

- ▶ Keep the area around vehicle sensors or cameras clear of any obstructions and clean.
- ▶ Have damage to the bumper, radiator grille or stone chipping in the area of the front and rear windows repaired at a qualified specialist workshop.

Particularly, keep the areas around the sensors and cameras free of dirt, ice or slush (→ page 294). The sensors and cameras must not be covered and the detection ranges around them must be kept free. Do not attach additional license plate brackets, advertisements, stickers, car foils or rock chip protection films in the detection range of the sensors and cameras. Make sure

174 Driving and parking

there are no overhanging loads protruding into the detection range.

If there is damage to a bumper or the radiator shell, or after an impact, have the function of the sensors checked at a qualified specialist workshop. Have damage or stone chipping in the area of the cameras on the front and rear windows repaired at a qualified specialist workshop.

- ❗ The rear-view camera can extend and retract automatically for the purpose of calibration, even though there is no camera image on the display.

Overview of driving systems and driving safety systems

- ABS (→ page 174)
- BAS (→ page 175)
- ESP® (→ page 175)
- ESP® Crosswind Assist (→ page 176)
- EBD (→ page 177)
- STEER CONTROL steering assistance system (→ page 177)

- HOLD function (→ page 177)
- Hill Start Assist (→ page 178)
- Start-off assist (→ page 179)
- ATTENTION ASSIST (→ page 179)
- Cruise control (→ page 181)
- Traffic Sign Assist (→ page 198)
- Suspension with adaptive damping adjustment (→ page 206)

Driving Assistance Package

- ❗ The following functions are part of the Driving Assistance Package. Certain functions are available only in some countries. Some functions are also available without the Driving Assistance Package, albeit with restricted functionality.

- Active Distance Assist DISTRONIC (→ page 183)
- Active Speed Limit Assist (→ page 188)
- Route-based speed adaptation (→ page 188)
- Active Brake Assist (→ page 194)
- Active Steering Assist (→ page 190)

- Active Emergency Stop Assist (→ page 192)
- Blind Spot Assist with exit warning (→ page 202)
- Active Lane Keeping Assist (→ page 204)

Parking Package

- ❗ The availability of individual functions depends on country and equipment.
- Rear view camera (→ page 206)
- 360° camera (→ page 210)
- Parking Assist PARKTRONIC (→ page 214)
- Active Parking Assist (→ page 218)

Function of ABS

The Anti-lock Brake System (ABS) regulates the brake pressure in critical driving situations:

- During braking, for instance, at maximum full-stop braking or if there is insufficient tire traction, the wheels are prevented from locking.
- Vehicle steerability while braking is ensured.

If ABS intervenes when braking, you will feel a pulsing in the brake pedal. The pulsating brake pedal can be an indication of hazardous road conditions and can serve as a reminder to take extra care while driving.

System limits

- ABS is active from speeds of approx. 3 mph (5 km/h).
- ABS may be impaired or may not function if a malfunction has occurred and the yellow  ABS warning lamp lights up continuously after the vehicle is started.

Function of BAS

▲ WARNING Risk of an accident caused by a malfunction in BAS (Brake Assist System)

If BAS is malfunctioning, the braking distance in an emergency braking situation is increased.

- ▶ Depress the brake pedal with full force in emergency braking situations. ABS prevents the wheels from locking.

The Brake Assist System (BAS) supports your emergency braking situation with additional brake force.

If you depress the brake pedal quickly, BAS is activated:

- BAS automatically boosts the brake pressure.
- BAS can shorten the braking distance.
- ABS prevents the wheels from locking.

The brakes will function as usual once you release the brake pedal. BAS is deactivated.

ESP® (Electronic Stability Program)

Function of ESP®

▲ WARNING Risk of skidding if ESP® is deactivated

If you deactivate ESP®, ESP® cannot carry out vehicle stabilization.

- ▶ ESP® should only be deactivated in the following situations.

! **NOTE** Mercedes-AMG vehicles

- ▶ Observe the notes in the Supplement. You could otherwise fail to recognize dangers.

The Electronic Stability Program (ESP®) can monitor and improve driving stability and traction in the following situations within physical limits:

- When starting off on wet or slippery roads.
- When braking.

If the vehicle deviates from the direction desired by the driver, ESP® can stabilize the vehicle by intervening in the following ways:

- One or more wheels are braked.
- The engine output is adapted according to the situation.

When ESP® is deactivated, the  warning lamp lights up continuously:

- Driving stability will no longer be improved.
- The drive wheels could spin.

- ETS/4ETS traction control is still active.

When the  warning lamp flashes, one or several wheels has reached its grip limit:

- Adapt your driving style to suit the current road and weather conditions.
- Do not deactivate ESP®.
- Depress the accelerator pedal only as far as is necessary when starting off.

To improve traction, ESP® can be switched off in the following situations:

- When using snow chains.
- In deep snow.
- On sand or gravel.

 Spinning the wheels results in a cutting action, which enhances traction.

If the  warning lamp lights up continuously, ESP® is not available due to a malfunction.

Observe the following information:

- Indicator and warning lamps (→ page 415)
- Display messages (→ page 364)

ETS/4ETS

ETS/4ETS traction control (Electronic Traction System) is part of ESP® and makes it possible to pull away and accelerate on a slippery road.

ETS/4ETS can improve the vehicle's traction by intervening in the following ways:

- The drive wheels are braked individually if they spin.
- More drive torque is transferred to the wheel or wheels with traction.

Influence of drive program on ESP®

The drive programs enable ESP® to adapt to different weather and road conditions as well as the driver's preferred driving style.

(→ page 154) Depending on the selected driving mode, the appropriate ESP® mode will be activated.

Function of ESP® Crosswind Assist

ESP® Crosswind Assist detects sudden gusts of side wind and helps the driver to keep the vehicle in the lane:

- ESP® Crosswind Assist operates at vehicle speeds between approximately 50 mph (80 km/h) and 125 mph (200 km/h) when you are driving straight ahead or cornering slightly.
- The system stabilizes the vehicle by applying the brakes to specific wheels on one side.

Activating/deactivating ESP® (Electronic Stability Program)

Multimedia system:



 ESP® can be activated/deactivated using quick access only when at least one other function is available in quick access. ESP® can otherwise be found on the [Assistance](#) menu.

! NOTE Mercedes-AMG vehicles

▶ Observe the notes in the Supplement. You could otherwise fail to recognize dangers.

- ▶ Select **ESP**.
- ▶ Select **On** or **Off**.

ESP® is deactivated if the  ESP® OFF warning lamp lights up continuously on the driver display.

Observe the information on the warning lamps and the display messages that may be shown on the driver display.

Function of EBD

Electronic Brakeforce Distribution (EBD) is characterized by the following:

- Monitoring and regulating the brake pressure on the rear wheels.
- Improved driving stability when braking, especially on bends.

Function of STEER CONTROL

STEER CONTROL assists you by transmitting a noticeable steering force to the steering wheel in the direction required for vehicle stabilization.

This steering recommendation is given in the following situations:

- both right wheels or both left wheels are on a wet or slippery road surface when you brake
- the vehicle starts to skid

System limits

STEER CONTROL may be impaired or may not function in the following situations:

- ESP® is deactivated.
- ESP® is malfunctioning.
- The steering is malfunctioning.

If ESP® is malfunctioning, you will be assisted further by the power steering.

HOLD function**■ HOLD function**

The HOLD function holds the vehicle at a standstill without requiring you to depress the brake pedal, e.g. while you are waiting in traffic.

The HOLD function is only an aid. The responsibility for the vehicle safely standing still remains with the driver.

System limits

The HOLD function is intended only to provide assistance during driving and is not a sufficient means of safeguarding the vehicle against rolling away when stationary.

- The gradient must not be greater than 30%.

■ Activating/deactivating the HOLD function

▲ WARNING Risk of an accident due to the HOLD function being active when you leave the vehicle

If the vehicle is only braked with the HOLD function it could, in the following situations, roll away:

- If there is a malfunction in the system or in the power supply.
 - If the HOLD function is deactivated by depressing the accelerator pedal or brake pedal, e.g. by a vehicle occupant.
- ▶ Always secure the vehicle against rolling away before you leave it.

Requirements

- The vehicle is stationary.
- The driver's door is closed or the driver is correctly belted.
- The vehicle has been started or has been automatically switched off by the ECO start/function.

- The electric parking brake has been released.
- The transmission position **D**, **R** or **N** is engaged.

Activating the HOLD function

- ▶ Depress the brake pedal, and after a short time quickly depress further until the **HOLD** display appears on the driver display.
- ▶ Release the brake pedal.

Deactivating the HOLD function

- ▶ Depress the accelerator pedal to start off. or
- ▶ Depress the brake pedal until **HOLD** disappears from the driver display.

The HOLD function is also deactivated in the following situations:

- The parking position **P** is engaged.
- The vehicle is secured with the electric parking brake.

In the following situations, the vehicle is held by the parking position **P** and/or electric parking brake:

- The seat belt is unfastened and the driver's door is opened.
 - The vehicle is switched off.
 - There is a system malfunction.
 - The power supply is insufficient.
- ▶ Immediately depress the brake pedal firmly. The HOLD function is deactivated.
 - ▶ Additionally secure the vehicle against rolling away.

Function of Hill Start Assist

▲ WARNING Risk of accident and injury due to the vehicle rolling away

After a short time, Hill Start Assist no longer holds the vehicle.

- ▶ Swiftly move your foot from the brake pedal to the accelerator pedal. Do not

leave the vehicle when it is being held by Hill Start Assist.

Hill Start Assist holds the vehicle for a short time when you pull away uphill under the following conditions:

- The transmission position **D** or **R** for starting off uphill is selected.
- The electric parking brake has been released.

This gives you enough time to move your foot from the brake pedal to the accelerator pedal and depress it without the vehicle rolling away immediately.

Start-off assist

Function of the start-off assist

The start-off assist enables optimal vehicle acceleration from a standstill. For this, a suitably high-grip road surface is required and the tires and vehicle must also be in good condition.

Do not activate the start-off assist on public roads.

Be sure to observe the safety notes and information on ESP® (→ page 175).

Activating the start-off assist

⚠ WARNING Risk of skidding and having an accident from wheels spinning

When you use start-off assist, individual wheels could spin and you could lose control of the vehicle.

If ESP® is deactivated, there is a risk of skidding and accident!

- ▶ Make sure that no persons or obstacles are in the close vicinity of your vehicle.

- ▶ Deactivating ESP® (→ page 176).
- ▶ Move the steering wheel to the straight-ahead position.
- ▶ Depress the brake pedal firmly with your left foot and keep it depressed.
- ▶ Engage the **D** drive position (→ page 158).
- ▶ Select the sportiest available drive program **S** or **S** (→ page 154).

- ▶ Rapidly depress the accelerator pedal fully.
- ▶ Take your foot off the brake, but keep the accelerator pedal depressed. The vehicle pulls away at maximum acceleration.
- ▶ Switch on ESP® once the acceleration procedure is complete. ESP® will otherwise not be able to stabilize the vehicle if the vehicle starts to skid or a wheel starts to spin.

Canceling the start-off assist

- ▶ Remove your foot from the accelerator pedal.
- ▶ Reactivate the ESP®.

ATTENTION ASSIST

Function of ATTENTION ASSIST

ATTENTION ASSIST assists you on long, monotonous journeys, e.g. on highways and trunk roads. If indicators of fatigue or increasing lapses in concentration on the part of the driver are detected, the system suggests taking a break.

ATTENTION ASSIST serves solely as an aid. It cannot always promptly detect fatigue or lapses in

concentration. The system is not a substitute for a well-rested and attentive driver. On long journeys, take regular, timely breaks to allow for adequate recovery.

You can choose between two settings:

- **Standard:** normal system sensitivity.
- **Sensitive:** higher system sensitivity. The driver is warned earlier and the attention level detected by ATTENTION ASSIST is adapted accordingly.

If fatigue or increasing lapses in concentration is detected, the driver display shows the warning: **ATTENTION ASSIST: Take a Break!** You can acknowledge the message and take a break if necessary. If you do not take a break and ATTENTION ASSIST continues to detect increasing lapses in concentration, you will be warned again after a minimum of 15 minutes.



The following information is displayed on the driver display:

- journey time since the last break.
- the attention level determined by ATTENTION ASSIST

The more segments ① of the circle displayed, the higher the detected attention level. Fewer segments ① are displayed in the circle as the attention level decreases.

If ATTENTION ASSIST is unable to calculate the attention level and cannot issue a warning, the **System Suspended** message appears.

If the driver display shows a warning, the MBUX multimedia system offers to search for a rest area. You can select a rest area and start navigation to this rest area.

When you restart the vehicle, ATTENTION ASSIST is automatically switched on. The last selected sensitivity level remains stored.

System limits

ATTENTION ASSIST is active in the 37 mph (60 km/h) to 124 mph (200 km/h) speed range. If the system is unavailable due to a malfunction, the ATTENTION ASSIST warning lamp  lights up continuously on the driver display.

Functionality of ATTENTION ASSIST is restricted, and warnings may be delayed or not issued at all in the following situations in particular:

- If you have been driving for less than approximately 30 minutes
- If the road condition is poor (uneven road surface or potholes)
- If there is a strong side wind

- If you adopt a sporty driving style (high cornering speeds or high rates of acceleration)
- If the Active Steering Assist function of Active Distance Assist DISTRONIC is active
- If the clock is set to the incorrect time.
- If you change lanes and vary your speed frequently in active driving situations.

Observe also any information regarding display messages that can be displayed on the driver display.

The ATTENTION ASSIST drowsiness or alertness assessment is reset and restarted when continuing the journey in the following situations:

- You switch off the vehicle.
- If you unfasten your seat belt and open the driver's door (e.g. to change drivers or take a break).

Setting ATTENTION ASSIST

Multimedia system:

→  ► Settings ► Assistance
► Assistance ► ATTENTION ASSIST

Setting the sensitivity

- ▶ Select  next to ATTENTION ASSIST.
- ▶ Select **Standard** or **Sensitive**.

Speed control cruise control

Function of cruise control

Cruise control regulates the speed to the value selected by the driver.

Forexample, the stored speed is not deleted if you accelerate to overtake. If you remove your foot from the accelerator pedal after overtaking, cruise control will resume speed regulation back to the stored speed.

You can set any speed above 15 mph (20 km/h) up to the maximum design speed.

Observe the notes on driving systems and your responsibility; you may otherwise fail to recognize potential dangers (→ page 172).

Mercedes-AMG vehicles: cruise control is available up to a maximum speed of 155 mph (250 km/h).

Notifications on the driver display

 **Gray:** cruise control is selected but not yet active or temporarily in passive mode.

 **Green:** cruise control is active.

A stored speed is shown below the display  and is indicated in the speedometer.

System limits

Cruise control may be unable to maintain the stored speed on uphill gradients. The stored speed is resumed when the gradient evens out.

On long and steep downhill gradients, you must change down to a lower gear in good time. This is particularly important when driving a laden vehicle. You are thus making full use of the engine's braking effect. This will take some of the strain off the brake system and prevent the brakes from overheating and wearing too quickly.

Do not use cruise control in the following situations:

- in traffic situations that require frequent changes of speed, e.g. in heavy traffic, on winding roads
- on slippery roads. Accelerating can cause the drive wheels to lose traction and the vehicle could then begin skidding.
- when visibility is poor

Operating cruise control

⚠ WARNING Risk of accident due to stored speed

If you call up the stored speed and this is lower than your current speed, the vehicle decelerates.

- ▶ Take into account the traffic situation before calling up the stored speed.

Requirements:

- The transmission is in position **D**.
- The vehicle speed is at least 15 mph (20 km/h).

- ESP® must be activated, but not intervening.
- Cruise control is selected.

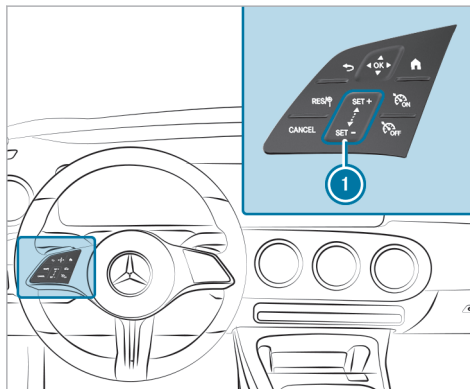

Steering wheel control panel for cruise control

RES/Ⓜ

Adopts the stored/detected speed

CANCEL

Deactivating cruise control

① SET + SET -

Control panel to increase/decrease speed



Switching on cruise control



Switching off cruise control

Switching on cruise control:

- ▶ Press **RES/Ⓜ**.

Activating cruise control:

- ▶ Press **SET +** or **SET -** on the control panel ①. The current vehicle speed is stored and maintained by the vehicle.

or

- ▶ Press **RES/Ⓜ**. The last stored speed is called up and maintained by the vehicle.

If the last stored speed has previously been deleted, the current vehicle speed is stored.



- ① When you switch off the vehicle, the last speed stored is deleted.

Increasing/decreasing the stored speed:

- ▶ To increase the stored speed: swipe upwards from the bottom of the control panel ①.
 - The stored speed is increased by 1 mph (1 km/h).

- ▶ To decrease the stored speed: swipe downwards from the top of the control panel .
 - The stored speed is decreased by 1 mph (1 km/h).



or

- ▶ Briefly press  or  on the control panel .

The stored speed is increased or decreased to the following values depending on the unit:

- **mph:** the next value ending in 5
- **km/h:** the next value ending in 0

or

- ▶ Accelerate the vehicle to the desired speed.
- ▶ Press  on the control panel .

Adopting a detected speed:

If cruise control is activated and Traffic Sign Assist has detected a traffic sign with a maximum permissible speed and this is displayed on the driver display:

- ▶ Press . The maximum permissible speed shown by the traffic sign is stored, and the vehicle maintains this speed.

Deactivating cruise control

- ▶ Press .

Switching off cruise control

- ▶ Press .

-  If you brake, deactivate ESP® or if ESP® intervenes, cruise control is deactivated.

Active Distance Assist DISTRONIC

Function of Active Distance Assist DISTRONIC

-  The Active Distance Assist DISTRONIC described for vehicles without the Driving Assistance Package is an on-demand feature (country-dependent) (→ page 25).

Active Distance Assist DISTRONIC maintains the set speed on free-flowing roads. If vehicles are detected ahead the set distance is maintained, if necessary until the vehicle comes to a standstill.

The vehicle accelerates or brakes depending on the distance to the vehicle in front and the set speed.

The speed and distance to the vehicle in front are set and saved using the steering wheel.

Available speed range: 15 mph (20 km/h) - 100 mph (160 km/h)

Other features of Active Distance Assist DISTRONIC:

- Adjusts the driving style depending on the selected drive program
- Initiates acceleration to the stored speed if the turn signal indicator is switched on to change to the overtaking lane
- **Vehicles with Driving Assistance Package:**
 - Reacts to stationary vehicles detected in urban speed ranges (except bicycles and motorcycles)
 - Takes one-sided overtaking restrictions into account on freeways or multi-lane roads with separate roadways (country-dependent)

- ① In the Active Distance Assist menu, it is possible to set the driving mode of Active Distance Assist DISTRONIC. Depending on the selected drive program, the driving behavior is energy-saving, comfortable or dynamic (→ page 190).

If the vehicle is braked to a standstill by Active Distance Assist DISTRONIC on multi-lane, separate roadways, it can automatically follow the vehicle in front when driving off again, depending on the respective vehicle equipment. If a critical situation is detected when you are driving off, a visual and acoustic warning is issued indicating that the driver must now take control of the vehicle. The vehicle is not accelerated any further.

Observe the notes on driving systems and your responsibility, otherwise you may fail to recognize potential dangers (→ page 172).

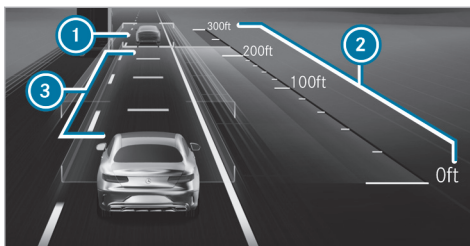



Notification on the driver display in the **Assistance** menu

- ① Vehicle in front
- ② Distance indicator
- ③ Set specified distance

The vehicle detected in front ① is highlighted in green. It may also be in the lane to the right of your vehicle in situations where it is not permitted to overtake on the left, for example, on UK free-ways.

Permanent status display

-  **Gray:** Active Distance Assist DISTRONIC selected but not yet active



-  **Green speedometer, gray vehicle:** Active Distance Assist DISTRONIC active, speed set

-  **Green:** Active Distance Assist DISTRONIC active and vehicle detected

The stored speed is shown under the permanent status display and highlighted in the speedometer. Active Distance Assist DISTRONIC's status display is grayed out when in passive mode.

If the speed of the vehicle in front or the ascertained target speed due to the route event ahead is less than the stored speed, the segments in the speedometer light up.

If you increase or decrease the set specified distance ③, the  display appears briefly.

- ① The green vehicle symbol  is displayed cyclically when the vehicle is ready to pull away.
- ① If the accelerator pedal is depressed while Active Distance Assist DISTRONIC is operational, the system can be switched to passive mode. The  **Suspended** message appears briefly on the driver display.

System limits

The system may be impaired or inoperative in the following instances, forexample:

- In snow, rain, fog, heavy spray, if there is glare, in direct sunlight or in greatly varying ambient light.
- The windshield in the camera's area is dirty, fogged up, damaged or covered.
- If the radar sensors are dirty or covered.
- In parking garages or on roads with steep uphill or downhill gradients.
- If there are narrow vehicles in front, such as bicycles or motorcycles.

In addition, one or more wheels may lose grip due to braking or acceleration on smooth or slippery roads, and the vehicle may begin skidding. If ESP® intervenes, Active Distance Assist DISTRONIC is deactivated.

Do not use Active Distance Assist DISTRONIC in these situations.

⚠ WARNING Risk of accident from acceleration or braking by Active Distance Assist DISTRONIC

Active Distance Assist DISTRONIC may accelerate or brake in the following cases, for example:

- If the vehicle pulls away using Active Distance Assist DISTRONIC.
- If the stored speed is called up and is considerably faster or slower than the currently driven speed.
- If Active Distance Assist DISTRONIC no longer detects a vehicle in front or does not react to relevant objects.

- ▶ Always carefully observe the traffic conditions and be ready to brake at all times.
- ▶ Take into account the traffic situation before calling up the stored speed.

⚠ WARNING Risk of accident due to insufficient deceleration by Active Distance Assist DISTRONIC

Active Distance Assist DISTRONIC brakes your vehicle with up to 50% of the possible deceleration. If this deceleration is not sufficient, Active Distance Assist DISTRONIC alerts you with a visual and acoustic warning.

- ▶ Adjust your speed and maintain a suitable distance from the vehicle in front.
- ▶ Brake the vehicle yourself and/or take evasive action.

⚠ WARNING Risk of accident if detection function of Active Distance Assist DISTRONIC is impaired

Active Distance Assist DISTRONIC does not react or has a limited reaction:

- when driving on a different lane or when changing lanes

- to pedestrians, animals, bicycles or stationary vehicles, or unexpected obstacles
- to complex traffic conditions
- to oncoming vehicles and crossing traffic

As a result, Active Distance Assist DISTRONIC may neither give warnings nor intervene in such situations.

▶ Always observe the traffic conditions carefully and react accordingly.

Operating Active Distance Assist DISTRONIC

Requirements:

- The electric parking brake has been released.
- ESP® is switched on and is not intervening.
- Transmission position **D** is engaged.
- All the doors are closed.
- The check on the radar sensor system has been successfully completed.

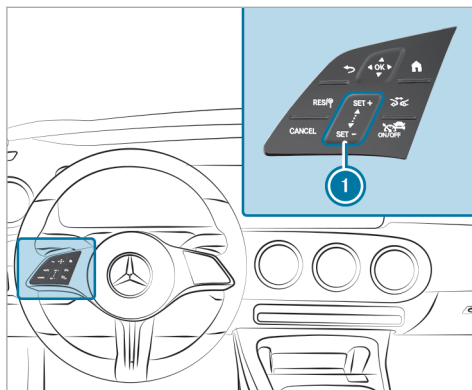

RES/Ⓟ

Adopts the stored/detected speed
Deactivates Active Distance Assist DISTRONIC

CANCEL

1 **SET +** **SET -**

Control panel to increase/decrease speed

↔

Increases/decreases the specified distance

RES/Ⓟ

Activates/deactivates Active Distance Assist DISTRONIC

▶ **To operate Active Distance Assist DISTRONIC:** press the respective button with only one finger or swipe across the control panel.

Activates/deactivates Active Distance Assist DISTRONIC

▶ Press **RES/Ⓟ**.

Activating Active Distance Assist DISTRONIC

▶ **To activate without a stored speed:** press the control panel **1** on the top **SET +** or on the bottom **SET -** or press **RES/Ⓟ**. Remove your foot from the accelerator pedal.

or



▶ **To activate with a stored speed:** press **RES/Ⓟ**. Remove your foot from the accelerator pedal. The last stored speed will be called up and maintained by the vehicle.

If the stored speed has been deleted, the current vehicle speed will be stored.

Increasing or decreasing the speed

- ▶ To increase the stored speed: swipe upwards from the bottom of control panel ①.
 - The stored speed will be increased by 1 mph (1 km/h).
- ▶ To decrease the stored speed: swipe downwards from the top of control panel ①.
 - The stored speed will be decreased by 1 mph (1 km/h).

or

- ▶ Briefly press the top  or bottom  of control panel ①. The stored speed will be increased or decreased by 5 mph (10 km/h).

or

- ▶ Accelerate the vehicle to the desired speed.
- ▶ Press the top  of control panel ①.

Adopting the speed restriction shown on the driver display

- ▶ Activate Active Distance Assist DISTRONIC: press ,  or .

- ▶ Adopt the displayed speed restriction: press . The speed restriction shown on the driver display will be adopted as the stored speed. The vehicle will adapt its speed to that of the vehicle in front, but only up to the stored speed, or will limit its speed accordingly.

- ① A speed restriction shown on the driver display will be adopted only while the vehicle is in motion, not when it is stationary.



Pulling away with Active Distance Assist DISTRONIC

- ▶ Activate Active Distance Assist DISTRONIC and remove your foot from the brake pedal.
- ▶ Press .

or

- ▶ Depress the accelerator pedal briefly and firmly. The functions of Active Distance Assist DISTRONIC will remain active.

Increasing or decreasing the specified distance from the vehicle in front

- ▶ Press . The  indicator will appear. The specified distance will be reduced by one level. If the lowest level is already selected, the selection will jump to the highest level.

Deactivating Active Distance Assist DISTRONIC

⚠ WARNING Risk of an accident due to Active Distance Assist DISTRONIC being active when you leave the driver's seat

If you leave the driver's seat while the vehicle is being braked by Active Distance Assist DISTRONIC only, the vehicle can roll away.

- ▶ Always deactivate Active Distance Assist DISTRONIC and secure the vehicle to prevent it from rolling away before you leave the driver's seat.

- ▶ Press .

- ❶ If you brake or deactivate ESP® or if ESP® intervenes, Active Distance Assist DISTRONIC will be deactivated.

■ Function of Active Speed Limit Assist

If a change in speed limit is detected and the automatic adoption of speed limits is switched on, this will automatically be adopted as the set speed (→ page 190). Speed limits below 12 mph (20 km/h) will not be adopted.

The vehicle's speed will be adjusted when the vehicle is level with the traffic sign at the latest. In the case of signs indicating entry into an urban area, the speed will be adapted according to the speed permitted within the urban area. The speed limit indicator on the driver's display will always be updated when the vehicle is level with the traffic sign.

If you are driving on German motorways with no speed limit, the system will use the speed stored for a stretch of road with no speed limit as the set speed. If you do not alter the set speed on a stretch of road with no speed limit, the recommended speed of 80 mph (130 km/h) will be adopted.

If Active Distance Assist DISTRONIC has been switched to passive mode as a result of you pressing the accelerator pedal, only speed limits that are higher than the set speed will be adopted.

The maximum permissible speed does not take the road condition and current weather and traffic conditions into consideration. Adjust your speed accordingly when necessary.

Observe the notes on driving systems and your responsibility; you may otherwise fail to recognize potential dangers (→ page 172).

System limits

The system limits of Traffic Sign Assist apply to the detection of traffic signs (→ page 198).

Speed limits below 12 mph (20 km/h) will not automatically be adopted by the system as the set speed. Temporary speed restrictions (e.g. for a specific time or due to weather conditions) cannot be unequivocally detected by the system.

Adjust your speed in these situations.

▲ WARNING Risk of accident due to speed adaptation via Active Speed Limit Assist

The speed limit adopted by Active Speed Limit Assist may be too high or otherwise erroneous in certain circumstances:

- in the case of speed limits below 12 mph (20 km/h)
- due to weather, e.g. in wet or foggy conditions

- ▶ Ensure that the vehicle speed always complies with the traffic regulations.
- ▶ Adjust the vehicle speed to the current traffic and weather conditions.

■ Function of route-based speed adaptation

When Active Distance Assist DISTRONIC is activated, the vehicle speed will be adapted accordingly to the route events ahead. Depending on the drive program selected, the vehicle will negotiate a route event ahead in an energy-saving, comfortable or dynamic manner. When the route event has been passed, the vehicle will accelerate again to the stored speed. The set distance to the vehicle

in front, vehicles detected ahead and speed restrictions ahead will be taken into account.

Route-based speed adaptation can be activated in the multimedia system (→ page 190).

The following route events will be taken into account:

- Bends
- Traffic circles
- T-intersections
- Turns and exits

Also, the speed will be reduced if the turn signal indicator is switched on and one of the following situations is detected:

- Turning off at intersections
- Driving in slowing-down lanes
- Driving in lanes adjacent to slowing-down lanes

The driver is responsible for choosing the right speed and observing other road users. This applies in particular to intersections, traffic circles

and traffic lights, as route-based speed adaptation does not brake the vehicle to a standstill.

When route guidance is active, the first speed adjustment will be carried out automatically. If the turn signal indicator is switched on, the selected route will be confirmed and further speed adjustment will be activated.

Speed adjustment will be canceled in the following cases:

- If the turn signal indicator is switched off before the route event and it is therefore assumed that the route event is not relevant to the driver
- If the driver depresses the accelerator or brake pedal during the process

System limits

Route-based speed adaptation does not take right of way regulations into account. The driver is responsible for complying with road traffic regulations and driving at a suitable speed.

In difficult conditions, the speed selection made by the system may not always be suitable. This applies to the following situations, for example:

- The road's course is not clearly visible
- Road narrowing
- Varying maximum permissible speeds in individual lanes, e.g. at toll stations
- Wet road surfaces, snow or ice

The driver will need to intervene accordingly in these situations.

WARNING Risk of accident in spite of route-based speed adaptation

Route-based speed adaptation can malfunction or be temporarily unavailable in the following situations:

- If the driver does not follow the calculated route
- If map data is not up-to-date or available
- In the event of roadworks
- In bad weather or road conditions

- If the accelerator pedal is depressed
 - In the event of electronically displayed speed limitations
- ▶ Adapt the speed to the traffic situation.

■ Setting the driving style of Active Distance Assist DISTRONIC

Requirements:

- Active Distance Assist DISTRONIC is activated.

Multimedia system:

→  ▶ Settings ▶ Assistance
▶▶ Driving ▶▶ Active Distance Assist

Selecting a driving style

▶ Select **Based on DYNAMIC SELECT**, **Dynamic** or **Comfortable**.

- ⓘ Additional information on Active Distance Assist DISTRONIC (→ page 183).

Setting speed adaptation

▶ Select **Adopt Speed Limit** or **Route-based Speed Adaptation**.

When these functions are active, the travel speed is adapted depending on the route events ahead or in accordance with a speed restriction.

- ⓘ If one of the following systems is activated, the detected speed can be manually adopted as the maximum permissible speed:
- Active Distance Assist DISTRONIC
 - Variable limiter
- ⓘ Additional information on speed adaptation (→ page 188).

Active Steering Assist

■ Function of Active Steering Assist

Active Steering Assist is available up to a speed of 100 mph (160 km/h).

The system helps you to stay in the center of the lane by means of moderate steering interventions. Depending on the vehicle speed, Active Steering

Assist uses the vehicles ahead and lane markings as a reference.

- ⓘ Depending on the respective country, Active Steering Assist can use the surrounding traffic as a reference in the lower speed range. If necessary, Active Steering Assist can also assist when you are driving outside the center of the lane, for example, to form an emergency corridor.

If the detection of lane markings and vehicles ahead is impaired, Active Steering Assist switches to passive mode. The system provides no support in this case.

Status display of Active Steering Assist



Gray: activated and in passive mode





Green: activated and active



Red, flashing: prompt to the driver to actively confirm or transition from active to passive mode, system limits detected



White, red hands: "hands on the steering wheel" prompt

- ❗ During the transition from active to passive mode, the  symbol is shown as enlarged and flashing. Once the system is in passive mode, the  symbol is shown as gray on the driver display.
- ❗ Depending on the selected vehicle settings, Active Steering Assist may be unavailable.

Steering and touch detection

The driver is required to keep their hands on the steering wheel at all times to ensure that they can intervene at any time to correct the course of the vehicle and keep it in lane. The driver must expect a change from active to passive mode or vice versa at any time.



If the system detects that the driver has not steered the vehicle for a considerable period of time or has removed their hands from the steering wheel, an initial visual warning is issued. The notification  appears on the driver display. If the driver still does not steer the vehicle, or gives no confirmation to the system, a warning tone sounds in addition to the visual warning message.

If the driver does not react to this warning for a considerable period, an emergency stop may be initiated (→ page 192).

The warning is not issued or stops as soon as the system detects the driver touching or steering the steering wheel.

Touch detection may be limited or inoperative if there is no direct contact between the hand and the steering wheel, e.g. when you are wearing gloves or if there is a steering wheel cover on the steering wheel.

If Active Steering Assist detects that a system limit has been reached, a visual warning is issued and a warning tone sounds.

Observe the notes on driving systems and your responsibility, otherwise you may fail to recognize potential dangers (→ page 172).

System limits

Active Steering Assist has a limited steering torque for lateral guidance. In some cases, the steering intervention is not sufficient to keep the vehicle in the lane or to drive through exits.

The system may be impaired or inoperative in the following situations:

- There is poor visibility, e.g. due to snow, rain, fog, heavy spray, greatly varying ambient light or dense shadows on the road.
- There is glare, e.g. from oncoming traffic, direct sunlight or reflections.
- Insufficient road illumination.
- The windshield is dirty, fogged up, damaged or covered in the vicinity of the camera, e.g. by a sticker.
- There are no lane markings in a given lane, or the markings are not easily discernible or change quickly, for example, in a construction area or at intersections.

- The lane markings are worn away, dark or covered up, e.g. by dirt or snow.
- If the distance to the vehicle in front is too short and the lane markings can therefore not be detected.
- The roadway is narrow and winding.
- There are obstacles on the lane or projecting out into the lane, such as object markers.

The system does not provide assistance in the following conditions:

- On very tight bends and when turning.
- When crossing intersections.
- At traffic circles or toll stations.
- When actively changing lane without switching on the turn signal indicator.
- When the tire pressure is too low.

⚠ WARNING Risk of accident if Active Steering Assist unexpectedly stops functioning

If the system limits of Active Steering Assist are reached there is no guarantee that the

system will remain active or will keep the vehicle in lane.

- ▶ Always keep your hands on the steering wheel and observe the traffic carefully.
- ▶ Always steer the vehicle paying attention to traffic conditions.

⚠ WARNING Risk of accident if Active Steering Assist unexpectedly intervenes

The detection of lane markings and objects may malfunction and cause unexpected steering interventions.

- ▶ Steer according to traffic conditions.

■ Activating/deactivating Active Steering Assist

Requirements:

- ESP® is activated, but is not intervening.
- Active Distance Assist DISTRONIC is activated.

Multimedia system:

➔  ➔ Settings ➔ Assistance
➔ Driving

- ▶ Activate or deactivate **Active Steering Assist**.

Function of Active Emergency Stop Assist

i The following function is available only in combination with the Driving Assistance Package.

Active Emergency Stop Assist monitors the steering wheel, as well as the accelerator and brake pedals. If the system detects a lack of driver activity or the vehicle is in danger of leaving the lane, a warning can be issued and an emergency stop initiated.

If Active Steering Assist is switched off, the system is available from a speed of approx. 37 mph (60 km/h).

If the system detects that the vehicle is in danger of leaving the lane, a warning can be issued and an emergency stop initiated.

- The driver has not touched the steering wheel for a certain while, or no steering movement is

detected for a lengthy period (depending on the vehicle equipment).

- Neither the accelerator nor the brake pedal is depressed.
- i** If Active Steering Assist is switched on and active, the system monitors only the steering wheel. If the driver has not touched the steering wheel for a certain while, a warning may be issued despite pedal actuation. Observe also the instructions on the touch detection of Active Steering Assist (→ page 190).



Active Emergency Stop Assist issues the following warnings in order:

- Display message **1** appears on the driver display.
- In addition to the display **1**, a warning tone sounds.
- The **Initiating Emergency Stop** message appears on the driver display, a continuous warning tone sounds and the vehicle will no longer accelerate.
- The vehicle speed is reduced in increments until the vehicle comes to a standstill. Sharp brake impulses are also effected.

When automatic braking is initiated, Active Distance Assist DISTRONIC is deactivated. Depending on the respective country, the hazard warning light system is also switched on.

When the vehicle has come to a standstill:

- the vehicle is secured with the electric parking brake.
- the vehicle is unlocked.

- if possible, an emergency call is made to the Mercedes-Benz emergency call center.

Before the **Initiating Emergency Stop** message is displayed, you can cancel Active Emergency Stop Assist by turning the steering wheel.

Once the **Initiating Emergency Stop** message has been displayed, you can cancel Active Emergency Stop Assist as follows:

- Accelerating or braking: braking is canceled, but the warning message, warning tone and electric power steering remain active.
- Steering: electric power steering is canceled, the warning message and warning tone remain active, and the vehicle continues to be braked
- Steering and accelerating or braking: The emergency stop and electric power steering are canceled. The warning message and the warning tone are canceled.

- ① Active Emergency Stop Assist can initiate an emergency stop a maximum of three times within a driving cycle. After that, Active Steering Assist and Active Emergency Stop Assist are disabled until the vehicle has been restarted.

System limits

For the detection of vehicles and other obstacles, observe the system limits of the following functions:

- Active Distance Assist DISTRONIC (→ page 183)
- Active Steering Assist (→ page 190)
- Active Lane Keeping Assist (→ page 204)
- Active Brake Assist (→ page 194)

The Active Emergency Stop Assist is inactive in the following case:

- Active Lane Keeping Assist and Active Steering Assist are switched off.

Active Brake Assist

Function of Active Brake Assist

Active Brake Assist consists of the following functions:

- Collision warning
- Autonomous braking function
- Situation-based brake force boosting
- **Vehicles Driving Assistance Package:** Evasive Steering Assist

Active Brake Assist can help you to minimise the risk of a collision with vehicles, cyclists or pedestrians, or to reduce the effects of such a collision.

If Active Brake Assist has detected a risk of collision, a warning tone sounds and the Active Brake Assist lamp  lights up.

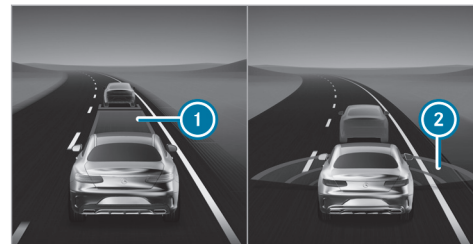

Notification on the driver display in the menu **Assistance**

- ① Distance insufficient
- ② Red radar waves

In the **Assistance** menu, an insufficient distance to the vehicle in front ① is displayed in red. If you further reduce the distance, the vehicle in front is also highlighted in red. When the system detects a risk of collision, red radar waves ② appear ahead of the vehicle.

- ① **Vehicles with PRE-SAFE®:** depending on the country, an additional haptic warning is given in the form of slight, repeated tensioning of the driver's seat belt.

If you do not react to the warning, autonomous braking can be initiated in critical situations.

In particularly critical situations, Active Brake Assist can also initiate autonomous braking directly. In this case, the warning tone and distance warning lamp  are simultaneous with the braking action.

If you apply the brakes yourself in a critical situation or apply the brakes during autonomous braking, situation-based braking assistance is given. The brake pressure increases up to maximum emergency braking if necessary.



If autonomous braking, situation-related based assistance or evasive action has occurred, pop-up

 appears on the driver display. It automatically disappears after a short time.

If the autonomous braking function or the situation-based braking assistance is triggered, additional preventive measures for occupant protection by PRE-SAFE® may also be initiated.

⚠ WARNING Risk of an accident caused by limited detection performance of Active Brake Assist

Active Brake Assist cannot always clearly identify objects and complex traffic situations.

In such cases, Active Brake Assist might:

- Give a warning or brake without reason
- Not give a warning or not brake

Active Brake Assist is only an aid. The driver is responsible for maintaining a sufficiently safe distance to the vehicle in front, vehicle speed and for braking in good time.

 Always pay careful attention to the traffic situation; do not rely on Active Brake Assist alone.

 Be prepared to brake or swerve if necessary.

If Active Brake Assist is deactivated or the functions are restricted, e.g. owing to activation of another driving system, the Active Brake Assist warning lamp  appears in the driver display.

If the system is unavailable owing to soiled or damaged sensors or a malfunction, or if the functions are restricted, the Active Brake Assist  warning lamp appears on the driver display.

Also observe the system limits of Active Brake Assist.

Collision warning

The collision warning can assist you in the following situations with an intermittent warning tone and the  warning lamp:

- at speeds up to approximately 155 mph (250 km/h) when approaching moving vehicles ahead.
- at speeds up to approximately 50 mph (80 km/h) when approaching stationary vehi-

cles, pedestrians walking along the road and moving cyclists ahead.

- at speeds up to approximately 43 mph (70 km/h) when approaching crossing pedestrians and cyclists.
- at speeds up to approximately 37 mph (60 km/h) when approaching stationary pedestrians and cyclists.

Autonomous braking function

At speeds above approximately 4 mph (7 km/h), the autonomous braking function can intervene in the following situations:

- at speeds up to approximately 155 mph (250 km/h) when approaching moving vehicles ahead.
- at speeds up to approximately 50 mph (80 km/h) when approaching moving cyclists ahead, pedestrians walking along the road and stationary vehicles.
- at speeds up to approximately 43 mph (70 km/h) when approaching crossing pedestrians and cyclists.

Situation-based brake force boosting

At speeds above approximately 4 mph (7 km/h), situation-related brake force boosting can intervene in the following situations.

- at speeds up to approximately 155 mph (250 km/h) when approaching moving vehicles ahead.
- at speeds up to approximately 50 mph (80 km/h) when approaching moving cyclists ahead, pedestrians walking along the road and stationary vehicles.
- at speeds up to approximately 43 mph (70 km/h) when approaching crossing pedestrians and cyclists.
- at speeds up to approximately 37 mph (60 km/h) when approaching stationary pedestrians and cyclists.

Canceling a brake application of Active Brake Assist

You can cancel a brake application of Active Brake Assist at any time by:

- firmly depressing the accelerator pedal or by kickdown
- releasing the brake pedal.

Active Brake Assist may cancel the brake application when one of the following conditions is fulfilled:

- You steer to avoid an obstacle.
- There is no longer a risk of collision.
- An obstacle is no longer detected in front of your vehicle.

Turning maneuver function (vehicles with Driving Assistance Package):

If the system detects a risk of a collision with an oncoming vehicle when turning across an oncoming lane, autonomous braking can be initiated at speeds below 9 mph (15 km/h) before you have left your own lane.

Active Evasive Steering Assist

WARNING Risk of accident despite Active Evasive Steering Assist

Active Evasive Steering Assist cannot always clearly identify objects and complex traffic situations.

In such cases, Active Evasive Steering Assist may:

- issue a warning or initiate a steering intervention without reason
- fail to issue a warning or initiate a steering intervention

Active Evasive Steering Assist can help to prevent a collision by automatically initiating a steering intervention.

- ▶ Always pay close attention to the road and traffic conditions and do not rely on Active Evasive Steering Assist alone.
- ▶ Be prepared to brake or swerve if necessary.

- ▶ Adjust your speed if there are pedestrians near the vehicle.

Active Evasive Steering Assist can automatically react to objects that are stationary or moving longitudinally in your lane.

Active Evasive Steering Assist has the following features:

- Detection of pedestrians, cyclists and vehicles.
- Assistance through autonomous steering intervention during a necessary evasive maneuver
- Autonomous activation if there is sufficient space in your own lane
- Reaction from a speed of approximately 18 mph (30 km/h) up to a speed of approximately 50 mph (80 km/h).

When Active Evasive Steering Assist is intervening, and for the duration of the evasive action, a warning tone is sounded and the distance warning lamp  flashes.

The steering assistance by Active Evasive Steering Assist can be canceled at any time by steering, accelerating or braking.

Active Evasive Steering Assist can intervene in the following speed ranges:

- when approaching stationary vehicles, pedestrians or cyclists at speeds from approximately 18 mph (30 km/h) to approximately 50 mph (80 km/h)
- when approaching pedestrians or cyclists moving longitudinally ahead at speeds from approximately 18 mph (30 km/h) to approximately 50 mph (80 km/h)

System limits

Full system performance is not yet available for a short time after switching on the vehicle or after driving off. Depending on the environmental conditions, it may take a few minutes before full system performance is available.

The system may be impaired or may not function, particularly in the following situations:

- In snow, rain, fog, heavy spray, glare, in direct sunlight or in varying ambient light.

- If the sensors are soiled, fogged up, damaged or covered.
- If the sensors are impaired owing to interference from other radar sources, e.g. strong radar reflections in parking garages.
- If a loss of tire pressure or a defective tire has been detected and displayed.
- In complex traffic situations where objects cannot always be clearly identified.
- If pedestrians or vehicles move quickly into the sensor detection range.
- if pedestrians are hidden by other objects.
- If the typical outline of a pedestrian cannot be distinguished from the background.
- If a pedestrian is not detected as such, e.g. owing to special clothing or other objects.
- On bends with a tight radius.
- If the driver's seat belt is not fastened.
- If there is no lane marking, or it is not clearly recognisable
- If the course of the road is nowhere near straight

Setting Active Brake Assist

Requirements:

- The vehicle is switched on.



Multimedia system:

  **» Settings » Assistance**
» Collision Avoidance



 Activate or deactivate the function.

 It is recommended that you always leave Active Brake Assist activated.

Switching off Active Brake Assist also switches off the distance warning function, the collision warning, the autonomous braking function and Active Evasive Steering Assist (with Driving Assistance Package - country-dependent).

-  If Active Brake Assist is deactivated, the  symbol appears in the status bar of the driver display and when the vehicle is next started the system is activated again.
-  The setting after starting the vehicle depends on the country.

Setting warning timing

-  Select  alongside **Active Brake Assist**.
-  Select **Early**, **Medium** or **Late**.

Traffic Sign Assist

Function of Traffic Sign Assist

 This function is an on-demand feature (→ page 25).

Traffic Sign Assist detects the traffic signs with the multifunction camera and compares them with the information from the digital road map of the navigation system. It assists you by displaying detected speed limits and overtaking restrictions on the driver display.

Speed limits can also be shown on the head-up display.

The system can issue a warning when you exceed the speed limit.

In some countries, the system can provide you with further functions and warn you when you are approaching pedestrian crossings. If the system detects that you are driving onto a section of road

in the wrong direction of travel, it will trigger a warning.

The camera also detects and analyzes traffic signs with a restriction indicated by an additional sign (e.g. in wet conditions).

Traffic Sign Assist shows only selected signs on the driver display. Actual traffic signs and speed limits have priority over traffic signs and speed limits shown on the driver display.

Observe the notes on driving systems and your responsibility; you may otherwise fail to recognize potential dangers (→ page 172).

Also observe the following information:

- select a speed adapted to the traffic, surroundings and weather conditions
- observe actual traffic signs
- observe applicable traffic rules and regulations

Observe the notes on driving systems and your responsibility; you may otherwise fail to recognize potential dangers (→ page 172).

Indicators on the driver display

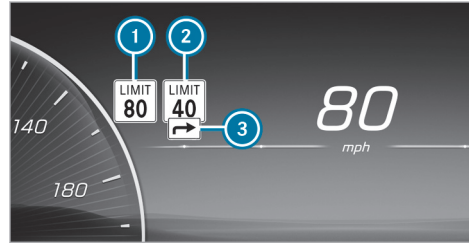

(Example)

- 1 Permissible speed
- 2 Permissible speed when there is a restriction
- 3 Additional sign with restriction

The system can show up to two traffic signs on the driver display simultaneously. The system will always prioritize displaying speed restrictions. No more than one traffic sign with a maximum permissible speed can be shown on the head-up display. If two speed signs are shown on the driver display, e.g. in the event of detected restrictions, the value of left-hand speed restriction 1 will

always be conveyed to the cruise control or Active Distance Assist DISTRONIC for acceptance and shown on the head-up display.

Important information from other systems may cause traffic signs to be hidden for a short time.

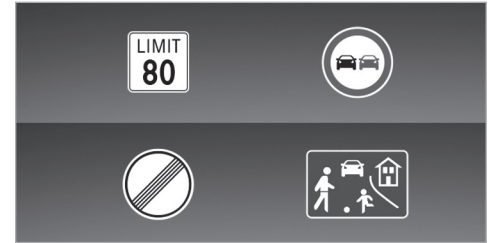

Examples of traffic signs that can be displayed

Traffic Sign Assist can detect and display the following traffic signs 1:

- speed restrictions
- end of the speed restriction
- overtaking restrictions
- play streets

- recommended speeds

Traffic Sign Assist can detect the following additional signs  and evaluate relevance of the restrictions as required using auxiliary vehicle sensors:

- in wet conditions
- slippery road surfaces
- in fog
- temporary restrictions
- exits

Traffic Sign Assist also uses data from the digital street map in the navigation system. When you pass a city or city boundary or move from one road onto another, e.g. when joining or exiting a freeway, or when turning at a crossroads, the view on the driver display can thus also be updated without a traffic sign having been detected.

 Regularly update the digital road map of the navigation system to enable Traffic Sign Assist to work optimally.

Depending on vehicle equipment and country, the system can also display speed limits ahead on the

driver display and head-up display. The driver display can also show the distance to an upcoming lower speed limit. Information from the digital road map of the navigation system is used for this purpose. The **Assistance** menu can also display a dynamic visualization of the speed limit ahead.

If the Traffic Sign Assist cannot determine the current maximum permissible speed, e.g. due to a lack of signage, the following indicator will appear on the driver display:



Traffic Sign Assist is not available in all countries. This display will be shown permanently in the vehicle when you are traveling in countries where Traffic Sign Assist is not supported.

If the system is temporarily or permanently unavailable due to a technical malfunction or dirt on the windshield, a corresponding display message will appear on the driver display. The Traffic Sign Assist  warning lamp will also light up on the driver display in certain countries.

 Please also note the information on the display messages from Traffic Sign Assist (→ page 364).

Warning when the maximum permissible speed is exceeded

The system can warn you if you are about to exceed the maximum permissible speed. Depending on the country, you can set in the multimedia system by how much the maximum permitted speed may be exceeded before a warning is given. You can switch off the warning or set whether the warning should be visual (by flashing the traffic sign on the driver's display) or visual and audible. Depending on the country, the selection of the type of warning will be confirmed by an indicator on the driver display.

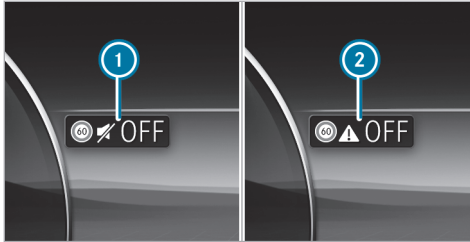

(Example)

- ① Visual warning only
- ② WARNING off

ⓘ The type, duration and deployment thresholds of the speed warning as well as the possibility of setting the deployment thresholds from which the warning is to be triggered are subject to the country-specific legislation of the country in which the vehicle is delivered.

Additional functions of Traffic Sign Assist (country-specific)

Warning for no-entry signs: Traffic Sign Assist can warn you if you drive the wrong way down a sec-

tion of road, such as on freeway on-ramps or one-way streets.

Warning at pedestrian crossings: if you are approaching a pedestrian crossing and pedestrians are in the danger zone or are moving towards it, Traffic Sign Assist can warn you up to a speed of approximately 44 mph (70 km/h).

System limits

The system may be impaired or inoperative in the following situations in particular:

- If visibility is poor, e.g. due to insufficient illumination of the road, highly variable shade conditions, rain, snow, fog, swirling dust or heavy spray.
- if there is glare, e.g. from oncoming traffic, direct sunlight or reflections.
- If there is dirt on the windshield in the vicinity of the multifunction camera or if the camera is fogged up, damaged or obscured.
- If the traffic signs are difficult to see because, for example, they are dirty, obscured, faded, iced over, damaged, inconveniently positioned, insufficiently illuminated or twisted.
- Active traffic signs with LED displays may not be detected correctly or at all due to technical factors, such as transmission frequency.
- If the information on the navigation system's digital map is incorrect, incomplete or out of date.
- If the signs, road markings or road layout are ambiguous, e.g. in the case of traffic signs at road work sites, at on-ramps and off-ramps, in the case of adjacent lanes or parallel roads or where there are pedestrian crossing markings at traffic lights.
- If the signage or road markings do not comply with the standard.
- If the signage, road markings or road guidance is country-specific and deviates from the route guidance of the navigation system, e.g. at or after road work sites.
- After sharp turns and tight bends, if traffic signs are outside the camera's field of vision.
- If you overtake vehicles with traffic signs attached to them.

Setting Traffic Sign Assist

Multimedia system:

-  → Settings → Assistance
- Assistance → Traffic Sign Assist

Activating or deactivating the speed limit warning

- ▶ Switch off **Speed Limit Warning**.
Following country-specific legislation, the speed limit warning remains deactivated until the next time the vehicle is switched on or off.

Change the type of speed limit warning

- ▶ Change the warning to **Visual** or **Visual & Audible**.

Setting the warning threshold

This value determines the speed at which a warning is issued when exceeded.

- ▶ Set the desired speed under Warning Threshold.

Blind Spot Assist

Function of Blind Spot Assist with exit warning

Blind Spot Assist uses two lateral, rear-facing radar sensors to monitor the area up to 130 ft (40 m) behind and 10 ft (3 m) next to your vehicle.

If at speeds above approximately 8 mph (12 km/h) a vehicle is detected and this vehicle subsequently enters the monitoring range directly next to your vehicle, the warning lamp in the outside mirror lights up red.

Status display on the driver display



Gray: the system is activated but inoperative.



Green: the system is activated and operational.

If a vehicle is detected close to your vehicle and you actuate the turn signal indicator in its direction, a double warning tone sounds and the red warning lamp in the outside mirror flashes. If the turn signal indicator remains switched on, all other detected vehicles are indicated only by the flashing of the red warning lamp.

If you overtake a vehicle quickly, no warning is given.

WARNING Risk of accident despite Blind Spot Assist

Blind Spot Assist does not react to vehicles approaching and overtaking you at a greatly different speed.

Blind Spot Assist cannot warn drivers in this situation.

- ▶ Always pay careful attention to the traffic situation and maintain a safe distance at the side of the vehicle.

Observe the notes on driving systems and your responsibility; you may otherwise fail to recognize potential dangers (→ page 172).

Exit warning

The exit warning is an additional function of Blind Spot Assist and can warn vehicle occupants about approaching vehicles when leaving the vehicle when stationary.

▲ WARNING Risk of accident despite exit warning

The exit warning neither reacts to stationary objects nor to persons or road users approaching you at a greatly differing speed.

The exit warning cannot warn drivers in these situations.

- ▶ Always pay particular attention to the traffic situation when opening the doors and make sure there is sufficient clearance.

If there is a vehicle in the monitoring range, this is indicated in the outside mirror. If a vehicle occupant opens the door on the side with the warning, a warning tone sounds and the warning lamp in the outside mirror starts to flash.

This additional function is available only when Blind Spot Assist is active. When the exit warning is activated, it can warn vehicle occupants for up to three minutes after switching the vehicle off. The exit warning is no longer available once the warning lamp in the outside mirror flashes three times.

The exit warning is only an aid and not a substitute for the attention of vehicle occupants. The responsibility for opening the doors and exiting the vehicle remains with the vehicle occupants at all times.

System limits

Blind Spot Assist may be restricted in the following situations, in particular:

- if there is dirt on the sensors or the sensors are obscured
- in poor visibility, e.g. owing to fog, heavy rain or snow
- if there are narrow vehicles, e.g. bicycles or motorcycles
- if the road has very wide or narrow lanes
- if vehicles are not driving in the middle of their lane

Warnings may be issued in error when driving close to crash barriers or similar continuous lane borders. Always make sure that there is sufficient distance to the side for other traffic or obstacles.

Warnings may be interrupted when driving alongside long vehicles, e.g. trucks, for a prolonged time.

Blind Spot Assist is not operational when reverse gear is engaged.

The exit warning may be limited in the following situations:

- when the sensors are covered by adjacent vehicles in narrow parking spaces
- when people approach the vehicle
- in the event of stationary or slowly moving objects

■ Activating/deactivating Blind Spot Assist

Multimedia system:

➔  ➔ Settings ➔ Assistance

➔ Collision Avoidance

▶ Activate or deactivate **Blind Spot Assist**.

Active Lane Keeping Assist

Function of Active Lane Keeping Assist

Active Lane Keeping Assist monitors the area in front of your vehicle using the multifunction camera (→ page 173).

It can protect you against unintentionally departing your lane. The system can guide you back into your lane with a course-correcting steering intervention, and warn you with tangible steering wheel feedback.

Active Lane Keeping Assist is available in the speed range between 37 mph (60 km/h) and 124 mph (200 km/h).

The system can intervene if the following conditions are met:

- Active Lane Keeping Assist detects a lane marking.
- You touch this lane marking with one of your front wheels.

If you activate the turn signal indicators, there is no steering intervention on that side.

There is no steering intervention if you leave your lane without activating the turn signal indicators, but there is a risk of collision with a moving obstacle in your own lane.

Vehicles with Blind Spot Assist or Driving Assistance Package: If the system detects an obstacle, e.g. another vehicle, in the adjacent lane, there is steering intervention despite the turn signal indicators.

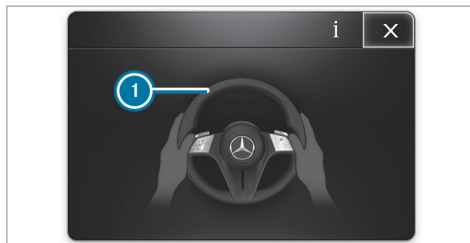

In the following cases the warning  appears on the driver display and a warning tone sounds:

- A steering intervention by Active Lane Keeping Assist lasts more than approximately ten seconds.

- There are two or more steering interventions by the systems within approximately three minutes, without steering action by the driver.

You can set the sensitivity of the system in the Active Lane Keeping Assist settings in order to determine the level of assistance. You can also determine whether the system is to react to broken lane markings or only to continuous lane markings (→ page 206).

Status displays of Active Lane Keeping Assist



White: Active Lane Keeping Assist is switched off.

If ESP® is switched off or a tire pressure loss warning is indicated, Active Lane Keeping Assist is automatically switched off.



Yellow: There is a malfunction. Also note any display messages.



Gray: Active Lane Keeping Assist is switched on but not ready.



Green: Active Lane Keeping Assist is switched on and ready.

 **Red:** Active Lane Keeping Assist has guided you back into your lane by a course-correcting steering intervention. If a tangible warning is also given in the steering wheel, the status display flashes. The lane marking of the affected side is shown in red.



Notification on the driver display in the menu **Assistance**

If one of your front wheels moves onto a detected lane marking, this is highlighted in red in the **Assistance** menu on the driver display.

System limits

In the following situations, there may be no course-correcting steering intervention, but a warning may be given in the steering wheel depending on the situation:

- if you clearly and actively steer, brake or accelerate.
- if a driving safety system is intervening, e.g. ESP® or Active Brake Assist
- if you have adopted a sporty driving style with high cornering speeds or high rates of acceleration.

The system may be impaired or inoperative in the following situations in particular:

- if there is poor visibility, e.g. owing to insufficient road illumination, highly variable shadows, rain, snow, fog or heavy spray
- if there is glare, e.g. from oncoming traffic, direct sunlight or reflections.
- If there is soiling on the windshield in the vicinity of the multifunction camera, or if the camera is fogged up, damaged or obscured.

- if the bumper is soiled in the area of the radar sensors, or if these are damaged or obscured
- if there are no lane markings, or several unclear lane markings are present for one lane, e.g. around roadworks.
- if the lane markings are worn, dark or covered.
- If the distance to the vehicle in front is too short and the lane markings can therefore not be detected.
- if the lane markings change quickly, e.g. lanes branch off, cross one another or merge.
- if the lanes are very narrow and winding.

Observe the notes on driving systems and your responsibility; you may otherwise fail to recognize potential dangers (→ page 172).

■ Activating/deactivating Active Lane Keeping Assist

Multimedia system:

-  ▶▶ Settings ▶▶ Assistance
- ▶▶ Collision Avoidance
- ▶▶ Active Lane Keeping Assist

- ▶ Activate or deactivate the function.

Alternatively, Active Lane Keeping Assist can be activated and deactivated via vehicle quick-access



- ⓘ The setting after starting the vehicle depends on the country.

■ Setting Active Lane Keeping Assist

Multimedia system:

-  ▶▶ Settings ▶▶ Assistance
- ▶▶ Collision Avoidance
- ▶▶ Active Lane Keeping Assist

Setting the sensitivity

- ▶ Select .
- ▶ Select **Early**, **Med.** or **Late**.

The last setting selected will be applied the next time the vehicle is started.

- ⓘ The standard setting of this function is country-dependent.
- ⓘ The function may not be available on vehicles with Driving Assistance Package, depending on the country.

■ Activating/deactivating assistance when lane markings are interrupted

- ▶ Select **Advanced Support**.

The last setting selected will be applied the next time the vehicle is started.

- ⓘ The standard setting of this function is country-dependent.
- ⓘ Depending on the country, this function must be activated in order for the full scope of Emergency Stop Assist to be available. Further information on Emergency Stop Assist (→ page 192).

■ Function of adaptive damping adjustment

The suspension with adaptive damping adjustment continually adjusts the characteristics of the suspension dampers to the current operating and driving conditions.

The damping is set individually for each wheel and is affected by the following factors:

- the road surface conditions
- the vehicle load
- the drive program selected
- the driving style

The drive program can be adjusted using DYNAMIC SELECT.

■ Rear view camera

■ Function of the rear view camera

The rear view camera serves solely as an aid. It is not a substitute for you having to pay attention to your surroundings. The responsibility for safe maneuvering and parking remains with you. Ensure that no persons, animals, objects, etc. are

in the maneuvering area while maneuvering and parking.

- ① The area behind the vehicle is displayed as a mirror image, as it would appear in the inside mirror.

Vehicles without Parking Package

The following camera perspectives are available on the central display:

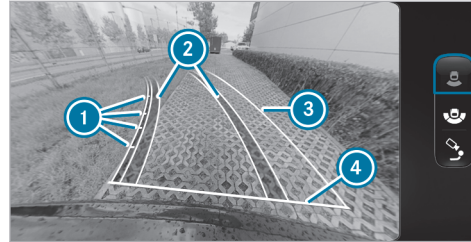

Standard view (example)

- ① Guide lines at a distance of approximately 1.6 ft (0.5 m), 3.3 ft (1.0 m), 5 ft (1.5 m) and 9.9 ft (3.0 m) from the rear area
- ② Path indicating the route the wheels will take at the current steering angle (dynamic)
- ③ Driven surface depending on the current steering angle (dynamic)
- ④ Guide line at a distance of approximately 1.0 ft (0.3 m) from the rear area



Wide-angle view (example)

- ⑤ Switching on the wide-angle view

Pedestrian braking function

- ① This function is available only in vehicles without the Parking Package. Vehicles with the Parking Package are equipped with maneuvering assistant functions (→ page 223).

The pedestrian braking function can prevent collisions with pedestrians when the vehicle is backing up at slow speeds. If the rear view camera detects a person in the vehicle's path, the vehicle can be braked to a standstill.

The pedestrian braking function can intervene under the following conditions:



- The vehicle is backing up at a speed below 9 mph (15 km/h).
- The camera image is shown on the central display.

When automatic braking is triggered, the symbol  appears in red in the camera image.

In addition, the message  **Pedestrian! For Emerg. Braking Off: Tap Here** appears.

The driver can close or ignore this message. Pedestrian braking then remains active. When the driver taps the message, pedestrian braking is momentarily deactivated.

In the following cases, the pedestrian braking function is activated again:

- The vehicle is traveling forwards at over 10 mph (16 km/h).
 - The vehicle is switched off and on again.
-  If the function is unavailable or deactivated, the symbol  appears in gray in the camera image.

The pedestrian braking function serves solely as an aid. It is not a substitute for you having to pay attention to your surroundings. The responsibility for safe maneuvering, parking and exiting parking spaces remains with you. Ensure that no persons, animals, objects, etc. are in the vehicle's path.

 **WARNING** Risk of accident caused by limited detection of the pedestrian braking function

The pedestrian braking function cannot always clearly detect people. Other obstacles are not detected by the function.

In these cases, the function may brake unnecessarily or not brake at all.

 Always pay careful attention to the traffic situation; do not rely on the pedestrian braking function alone.

 Be ready to brake.

In the following situations, the pedestrian braking function is not available:

- on uphill gradients

- if the rear view camera is not operational



Please also note the system limits of the rear view camera.

Vehicles with Parking Package

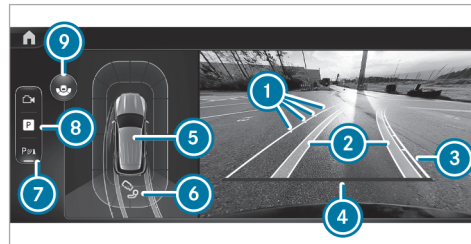
The following camera perspectives are available on the central display:



Camera Views menu (example)

-  Guide lines at a distance of approximately 1.6 ft (0.5 m), 3.3 ft (1.0 m), 5 ft (1.5 m) and 9.9 ft (3.0 m) from the rear area
-  Path indicating the route the wheels will take at the current steering angle (dynamic)

- ③ Driven surface depending on the current steering angle (dynamic)
- ④ Guide line at a distance of approximately 1.0 ft (0.3 m) from the rear area
- ⑤ Warning display of Parking Assist PARKTRONIC (→ page 214)
- ⑥ Trailer view (depending on the respective equipment) or rear view camera
- ⑦ Activating/deactivating Parking Assist PARKTRONIC (→ page 217)
- ⑧ Menu [Parking Assistance](#)
- ⑨ Wide-angle view
- ⓘ When Active Parking Assist is active, the paths ② are displayed in green (→ page 218).



Wide-angle view (example)

- ⑥ Warning display of Parking Assist PARKTRONIC (→ page 214)
- ⑦ Activating/deactivating Parking Assist PARKTRONIC (→ page 217)
- ⑩ Standard view

System limits

If the system is not ready for operation, the message [System Inoperative](#) appears on the driver display and/or on the central display.

If a camera perspective is selected and the central display is temporarily black or does not show a camera image, the camera system is also faulty or is not ready for operation.

⚠ WARNING Risk of accident due to functional limitations of the rear-view camera

Functional limitations of the rear-view camera could lead to a risk of collision with persons or objects.

- ▶ Do not use the rear-view camera if its functions are limited.
- ▶ Ensure that no persons, animals, objects, etc. are in the maneuvering area while maneuvering and parking.

The rear view camera will not function or will function only partially in the following situations:

- You are driving forwards at a speed greater than approximately 10 mph (16 km/h).
- The trunk lid is open.
- The weather conditions are poor, e.g. heavy rain, snow, fog, storm or spray.
- The ambient light is poor, e.g. at night or if a light is shining into the camera.

- The camera lens is obstructed, dirty or fogged up. Observe the notes on cleaning the rear view camera (→ page 294).
- The camera or rear of your vehicle is damaged. In this case, have the camera, its position and setting checked at a qualified specialist workshop.

The field of vision and other functions of the camera system may be restricted due to additional vehicle attachments (e.g. license plate bracket or bicycle rack).

- ⓘ The contrast of the display may be impaired by direct sunlight or by other light sources, e.g. when driving out of a garage. Particular attention must be afforded in this case.
- ⓘ Have the display repaired or replaced if, for example, its use is considerably restricted due to pixel errors.

Observe also the information on vehicle sensors and cameras (→ page 173).

360° camera

Function of the 360° camera

The 360° camera is a system comprising four cameras that cover the immediate vehicle surroundings. The cameras support you, for example, when parking or when exits are difficult to see.

The 360° camera includes the following cameras and evaluates their images:

- Rear view camera
- Front camera
- Two outside mirror cameras

The cameras serve solely as aids and may show a distorted view of obstacles, show them incorrectly or even omit them altogether. They are not a substitute for you having to pay attention to your surroundings. The responsibility for safe maneuvering and parking remains with you. Ensure that no persons, animals, objects, etc. are in the maneuvering area while maneuvering and parking.

The following camera perspectives are available on the central display:

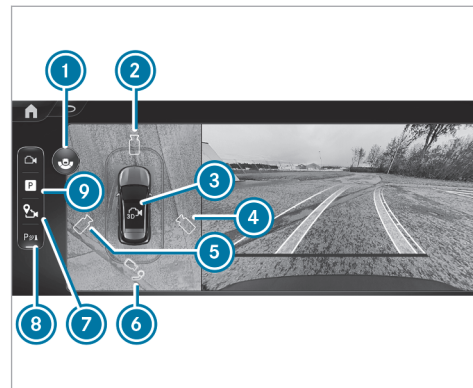

Overview of **Camera Views** menu (example)

- ① Switching between standard view and wide-angle view
- ② Image from the front camera
- ③ 3D auto view
- ④ 3D view right-hand side of the vehicle
- ⑤ 3D view left-hand side of the vehicle
- ⑥ Trailer view (depending on the respective equipment) or rear view camera

- ⑦ Set the GPS activation point (→ page 214)
- ⑧ Activating/deactivating Parking Assist PARKTRONIC (→ page 217)
- ⑨ Menu **Parking Assistance**
- ⓘ The warning display of Parking Assist PARKTRONIC is shown in all views (→ page 214).
- ⓘ Availability of the 3D-Auto-View ③ and 3D-View ④, ⑤ functions is dependent upon the respective equipment.

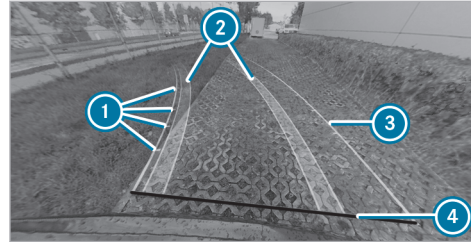

Function of the guide lines (example)

- ① Guide lines at a distance of approximately 1.6 ft (0.5 m), 3.3 ft (1.0 m), 5 ft (1.5 m) and 9.9 ft (3.0 m) from the rear area
- ② Path indicating the route the wheels will take at the current steering angle (dynamic)
- ③ Driven surface depending on the current steering angle (dynamic)
- ④ Guide line at a distance of approximately 1.0 ft (0.3 m) from the rear area
- ⓘ When Active Parking Assist is active, paths and guide lines are displayed in green instead of yellow (→ page 218).

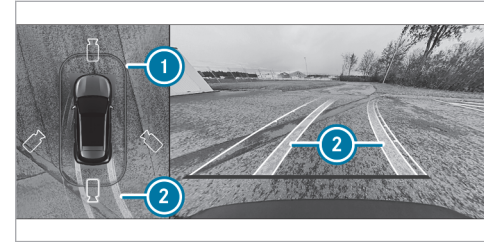

Image from the front camera or rear view camera (example)

- ① Warning display of Parking Assist PARKTRONIC (→ page 214)
- ② Path indicating the current steering angle

⚠ WARNING Risk of accidents due to objects not being displayed or being displayed in a distorted manner

Due to the projection of the cameras, objects in the 3D views may be strongly distorted or not displayed at all.

212 Driving and parking

- ▶ Make sure that there are no persons, animals or objects etc., in the maneuvering area while maneuvering and parking.

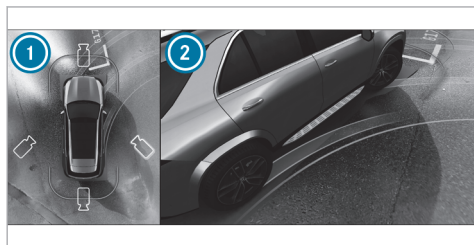

3D view left/right-hand side of the vehicle (example)

- 1 Top view with warning display of Parking Assist PARKTRONIC
- 2 Side view of the outside mirror cameras

In the 3D view, left/right-hand side of the vehicle, the virtual camera moves to the respective side of the vehicle 2. When you change the transmission position, the view is automatically adapted. In addition, the top view 1 is displayed with the Parking Assist PARKTRONIC warning display.

- i Display of the area beneath the vehicle may deviate from the actual circumstances.
- i The area behind the vehicle is **not** displayed as a conventional mirror image in the 3D views.

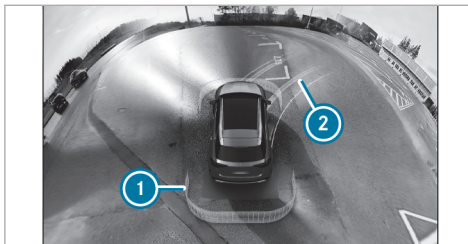

3D auto view (example)

- 1 Warning display of Parking Assist PARKTRONIC (→ page 214)
- 2 Guide lines

In the 3D auto view, the virtual camera moves to the standard view, facing forward from the rear above the roof. The view changes automatically when approaching obstacles.

If you touch the touchscreen, the view changes to a 3D view with free rotation. You can turn, tilt and zoom the views by touch.

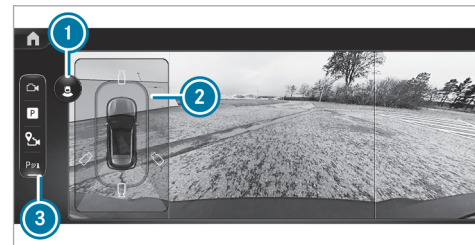

Wide-angle view (example)

- 1 Switching between standard view and wide-angle view
- 2 Display of Parking Assist PARKTRONIC (→ page 214)
- 3 Activating/deactivating Parking Assist PARKTRONIC (→ page 217)

System limits

If the system is not ready for operation, the message **System Inoperative** appears on the driver display and/or on the central display.

If a camera perspective is selected and the central display is temporarily black or does not show a camera image, the camera system is also faulty or is not ready for operation.

▲ WARNING Risk of accident due to restrictions in the function of the 360° camera

If the function of the 360° camera is restricted, there is a risk of collision with people or objects.

- ▶ Do not use the 360° camera in the event of function restrictions.
- ▶ Make sure that there are no persons, animals or objects etc., in the maneuvering area while maneuvering and parking.

The 360° camera will not function or will function only partially in the following situations, for example:

- You are driving forwards at a speed greater than approximately 10 mph (16 km/h).
- The doors are open.
- An outside mirror is not completely extended.
- The trunk lid is open.
- The weather conditions are poor, e.g. heavy rain, snow, fog, storm or spray.
- The ambient light is poor, e.g. at night or if a light is shining into the camera.
- The camera lens is obstructed, dirty or fogged up. Refer to the notes on cleaning the 360° camera (→ page 294).
- If cameras or vehicle components in which the cameras are installed are damaged. In this event, have the cameras, their positions and their setting checked at a qualified specialist workshop.

For technical reasons, the standard height of the vehicle may be altered if the vehicle is carrying a

heavy load and can result in inaccuracies in the guide lines and in the display of generated images.

The field of vision and other functions of the camera system may be restricted due to additional vehicle attachments (e.g. license plate bracket or bicycle rack).

- ⓘ Contrast of the display may be impaired by abrupt direct sunlight or other light sources, e.g. when driving out of a garage. Particular attention must be afforded in this case.
- ⓘ Have the display repaired or replaced if, for example, its use is considerably restricted due to pixel errors.

Observe also the information on vehicle sensors and cameras (→ page 173).

Calling up the 360° camera views using the button

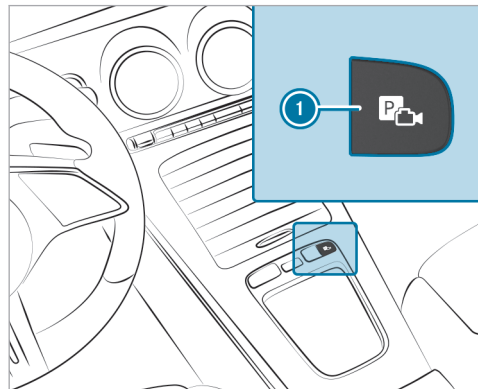

- ▶ Press button ①.
- ▶ Select **Camera Views** menu.
- ▶ Select the desired view in the multimedia system (→ page 210).

Selecting a view for the 360° camera (reverse gear)

- ▶ Engage reverse gear.
- ▶ Select the desired view in the multimedia system (→ page 210).

Managing 360° camera with GPS-activation positions

Multimedia system:

- ▶ ▶ Settings ▶ Assistance
- ▶▶ Camera

Renaming an activation position

- ▶ You can determine activation positions in the **Camera Views** menu (→ page 210).
- ▶ Select for the desired activation position.
- ▶ Select **Edit**.
- ▶ Enter a name and confirm.
The activation position is stored under the new name.

Deleting an activation position

- ▶ Select for the desired activation position.
- ▶ Select **Delete Entry**.
- ▶ Confirm the prompt.
The activation position is deleted.

Opening the camera cover

Multimedia system:

- ▶ ▶ Settings ▶ Assistance
- ▶▶ Camera

- ▶ Select **Open Camera Cover**.

- ▶ The camera cover closes automatically after some time, or after the vehicle is switched on or off.

Parking Assist PARKTRONIC

Function of Parking Assist PARKTRONIC

Parking Assist PARKTRONIC is an electronic parking assistance system that monitors the area surrounding your vehicle. The distance between your

vehicle and a detected obstacle is displayed visually and acoustically.

The passive side impact protection also warns you of obstacles to the side. These must be detected beforehand by the sensors in the front or rear bumper while driving by them. If you steer in the direction of a detected obstacle and there is a risk of a lateral collision, a warning is issued.

Passive side impact protection can be activated and deactivated via the multimedia system (→ page 218).

In order that front or rear obstacles to the side can be displayed, the vehicle must first travel a distance of at least half a vehicle length. Once the vehicle has travelled a distance of one vehicle length, obstacles on all sides can be shown.

Parking Assist PARKTRONIC serves solely as an aid. It is not a substitute for you having to pay attention to your surroundings. The responsibility for safe maneuvering, parking and exiting parking spaces remains with you. Ensure that no persons, animals, objects, etc. are in the maneuvering area while maneuvering and parking in / exiting parking spaces.

Displays on the central display

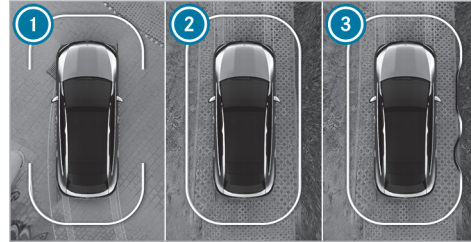

Example: vehicles with 360° camera

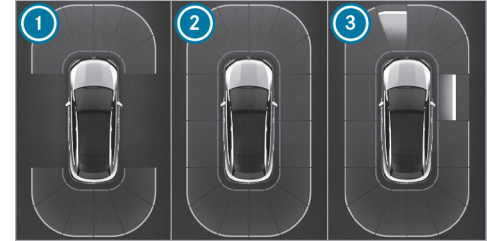

Example: vehicles with rear view camera

- ① Ready for display at the front and rear
- ② Ready for display all around
- ③ Ready for display all around and obstacles detected

As soon as Parking Assist PARKTRONIC is ready for display, the respective areas ① to ③ of the display are shown in blue.

The color of the display changes depending on the distance to the detected obstacle:

- **Blue:** > 3.3 ft (1 m) (no obstacles detected)
- **Yellow:** approximately 3.3 ft (1 m) - 2.3 ft (0.7 m)

216 Driving and parking

- **Orange:** approximately 2.3 ft (0.7 m) - 1.3 ft (0.4 m)
- **Red:** < 1.3 ft (0.4 m)

Vehicles with 360° camera: the boundary line shifts dynamically depending on the position and distance of the obstacles detected.

An intermittent warning tone also sounds depending on the distance to the obstacle detected. You can set the timing of the warnings in the multimedia system. In the **Warn Early** setting, the system warns you from a distance of 3.3 ft (1 m). In the standard setting, from a shorter distance of 1.3 ft (0.4 m).



Example: vehicles with 360° camera

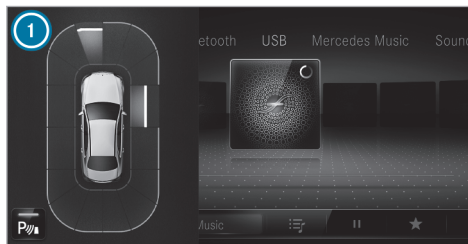

Example: vehicles with rear view camera

If you are not in the **Camera & Parking** menu and an obstacle in the vehicle's path is detected, a pop-up window ① appears on the central display if the following requirements are met:

- **Vehicles without Active Parking Assist:** when driving no faster than 8 mph (12 km/h).
- **Vehicles with Active Parking Assist:** when driving no faster than 11 mph (18 km/h).

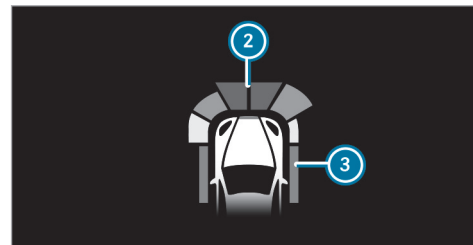

Head-up display (example)

Optionally, obstacles detected by Parking Assist PARKTRONIC from a distance of approximately 3.3 ft (1.0 m) in front ② and 2.3 ft (0.7 m) at the

sides ③ can also be displayed on the head-up display.

System limits

Parking Assist PARKTRONIC does not necessarily take into account the following obstacles:

- Obstacles below the detection range, e.g. persons, animals or objects
- Obstacles above the detection range, e.g. protruding loads, overhangs or loading ramps of truck
- Pedestrians or animals approaching the vehicle from the side
- Objects placed next to the vehicle

Obstacles on the sides are not shown in the following situations, for example:

- You park the vehicle and switch it off.
- You open the doors.

After the vehicle is restarted, obstacles must be detected again by driving past them before a new warning can be issued.

Observe also the system limits of the following systems:

- Rear view camera (→ page 206)
- 360° camera (→ page 210)

Observe the information on vehicle sensors and cameras; otherwise the system cannot function properly (→ page 173).

Problems with Parking Assist PARKTRONIC

If the Parking Assist PARKTRONIC display lights up red for approximately three seconds and then goes out, and the  symbol appears on the driver display, the system may have been deactivated due to signal interference. Start the vehicle again and check whether Parking Assist PARKTRONIC works in a different location.

If a warning tone also sounds, the causes may be as follows:

- **The sensors are dirty:** clean the sensors (→ page 294).
- **Parking Assist PARKTRONIC has been deactivated due to a malfunction:** restart the vehi-

cle. If the problem persists, consult a qualified specialist workshop.

Activating/deactivating Parking Assist PARKTRONIC

! **NOTE** Vehicle damage during parking or maneuvering due to objects at close range

Parking Assist PARKTRONIC may not detect certain objects close to the vehicle.

▶ When parking or maneuvering, look out in particular for objects that are underneath or above the sensors, e.g. flower pots or drawbars. Otherwise, the vehicle or other objects could be damaged.

Requirements:

- The camera menu is open.
- Or: the Parking Assist PARKTRONIC pop-up window is displayed.

▶ Tap  on the central display.

If the indicator lamp is lit, Parking Assist PARKTRONIC is active. If the indicator lamp does not light up or the symbol  is displayed, Parking Assist PARKTRONIC is not active.

 Parking Assist PARKTRONIC is automatically activated when the vehicle is started.

Alternatively, Parking Assist PARKTRONIC can be activated or deactivated in the quick-access menu.

■ Setting the warning tones of Parking Assist PARKTRONIC

Multimedia system:

  **Settings**  **Assistance**
 **Parking**  **PARKTRONIC**

Setting warning tones

- ▶ Select **Set Warning Tones**.
- ▶ Set the desired level under **Volume** or **Tone Pitch**.

Activating/deactivating audio fadeout

- ▶ Select **Audio Fadeout** and activate or deactivate **Audio Fade for Warnings**.

The volume of the media source currently playing is reduced when a warning tone sounds in Parking Assist PARKTRONIC.

or

- ▶ Select **Audio Fadeout** and switch **Audio Fadeout When in R** on or off.

The volume of the media source currently playing is reduced when reverse gear is engaged.

Setting warning timing

- ▶ Select **Time of Warning**.
- ▶ Set the desired warning time for **Front** or **Rear**.
- ▶ Activate or deactivate **Side Warning**.

Active Parking Assist

■ Function of Active Parking Assist

Active Parking Assist is an electronic parking assistance system that uses ultrasound with the

assistance of the rear view camera or 360° camera. When you are driving forwards up to approximately 22 mph (35 km/h), the system automatically measures parking spaces on both sides of the vehicle.

Active Parking Assist serves solely as an aid. It is not a substitute for you having to pay attention to your surroundings. The responsibility for safe maneuvering, parking and exiting parking spaces remains with you. Ensure that no persons, animals, objects, etc. are in the vehicle's path.

Active Parking Assist offers the following functions:

Vehicles with rear view camera



- Parking in parking spaces parallel to the roadway
- backing up into parking spaces perpendicular to the roadway

The parking space is freely selectable. The parking procedure is executed with the vehicle backing up.

Vehicles with 360° camera

- Parking in parking spaces parallel to the roadway
- Parking in parking spaces perpendicular to the roadway (either forwards or backing up as desired)
- Parking in parking spaces that can be detected as such only from markings (forexample at the roadside)
- Exiting parking spaces if you have parked using Active Parking Assist

The parking space is freely selectable. The parking direction (forwards or backing up) can also be freely selected, depending on the orientation of the parking space.



If Active Parking Assist is available, the notification  appears on the driver display. When the system detects parking spaces, the notification  appears. The arrows show the side of the roadway on which free parking spaces are located. These are then shown on the central display.

When Active Parking Assist is activated, the turn signal indicators are activated based on the calcu-

lated path of your vehicle. The parking and unparking procedures are assisted by acceleration, braking, steering and gear changes.

To start the parking procedure, press the button  (→ page 220).

Active Parking Assist will be canceled in the following situations:

- You press the button  again.
- You begin steering.
- You select the park position .
- You engage the electric parking brake.
- ESP® intervenes.
- You open the driver's door.

System limits

If the exterior lighting is malfunctioning, Active Parking Assist is not available.

Objects above or below the detection range of Active Parking Assist, e.g. protruding loads, overhangs or loading ramps of trucks or parking space boundaries are not detected when measuring the parking space. These are also not subsequently taken into account when calculating the parking

procedure. In some circumstances, Active Parking Assist may therefore prematurely guide you into the parking space or brake too late.

Certain environmental conditions, such as snowfall or heavy rain, may lead to a parking space being mismeasured. Parking spaces that are partially occupied by trailer drawbars might not be identified as such or may be measured incorrectly. Use Active Parking Assist only on level road surfaces with adequate grip.

⚠ WARNING Risk of accident due to objects located above or below the detection range of Active Parking Assist

If there are objects above or below the detection range, the following situations may arise:

- Active Parking Assist may steer too early.
- The vehicle may not stop in front of these objects.

There is a danger of collision!

- ▶ In these situations, do not use Active Parking Assist.

Active Parking Assist can also display unsuitable parking spaces, e.g. parking spaces in which parking is not permitted or on unsuitable surfaces.

Do not use Active Parking Assist in the following situations, for example:

- In extreme weather conditions, such as ice, packed snow or in heavy rain.
- When transporting a load that protrudes beyond the vehicle.
- If the parking space is on a steep downhill or uphill gradient.
- When snow chains are installed.
- Directly after a tire change or when spare tires are installed.
- If the tire pressure is too low or too high.
- On steep downhill gradients of more than approximately 15%.
- If the vehicle level has been offset, e.g. mounting the curb on one side (vehicles with level control).

Parking with Active Parking Assist

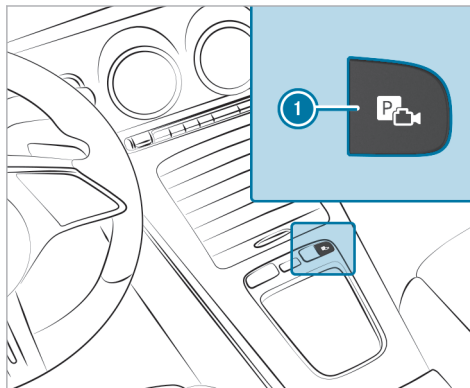

▶ Press the button ①.



Parking Assist menu (example for left-hand side of the screen)

▶ Select the menu **Parking Assistance** ②.

Parking spaces ③ detected by the system are shown on the central display.

At speeds greater than approximately 10 mph (16 km/h), the camera perspective on the right-hand side of the screen switches off.



Parking Assist menu (example)

When the vehicle is at a standstill, the indicated vehicle path (5) into the currently selected parking space (6) also appears.

- ▶ If a parking space is displayed: stop the vehicle.
- ▶ If necessary, select another parking space.
- ▶ **Vehicles with 360° camera:** to change the parking direction, tap the selected parking space again.
- ▶ **To start the parking procedure:** press the button (1) again.

or

- ▶ Depress the brake pedal and select **Start Parking Procedure** (4).
 - ▶ Take your hands off the steering wheel. The vehicle drives into the selected parking space.
 - ▶ The duration of the parking procedure is indicated by a progress bar.
- The turn signal indicator is switched on automatically when the parking procedure begins. You are responsible for selecting the turn signal indicator in accordance with the traffic conditions. If necessary, select the turn signal indicator accordingly.

⚠ WARNING Risk of accident due to vehicle swinging out while parking or pulling out of a parking space

While parking or exiting a parking space, the vehicle swings out and can drive onto areas of the oncoming lane. This could cause you to collide with objects or other road users.

- ▶ Pay attention to objects and other road users.

- ▶ Where necessary, stop the vehicle or cancel the parking procedure with Active Parking Assist.

Following completion of the parking procedure, the **Active Parking Assist Finished** message appears.

- ▶ Secure the vehicle against rolling away. When necessitated by legal requirements or local conditions: turn the wheels towards the curb.
- ⓘ You can stop the vehicle and change the transmission position during the parking procedure. The system then calculates a new vehicle path. If no new vehicle path is available, the transmission position can be changed again, or the process can be canceled.

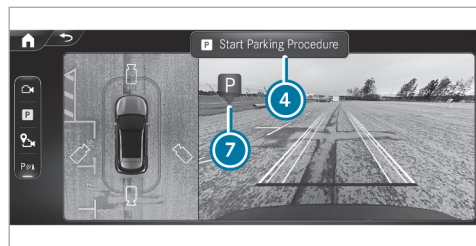

Immediate parking via the **Camera Views** menu

- ▶ Select the **Camera Views** menu.
- ▶ When the vehicle is stationary and in transmission position **R**, and the symbol **7** appears in the camera image: press the button **1** again.

or

- ▶ Depress the brake pedal and select **Start Parking Procedure 4**.
- The parking procedure is initiated for the detected parking space.

i The parking space and parking direction cannot be changed in immediate parking.

Exiting a parking space with Active Parking Assist

Requirements:

- The vehicle is equipped with a 360° camera.
- The vehicle has been parked with Active Parking Assist.

- ▶ Start the vehicle.

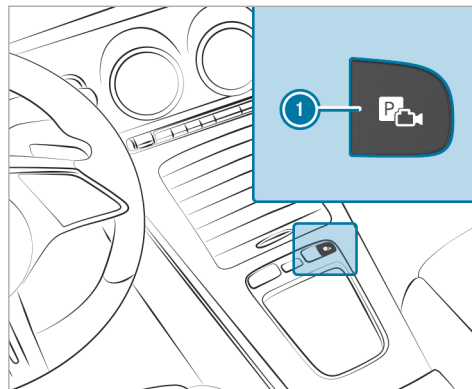

- ▶ Press the button **1**.

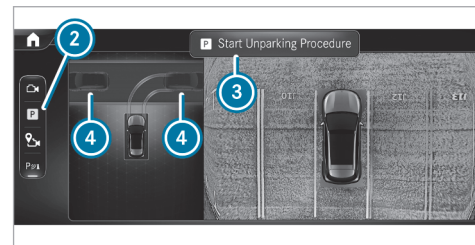

Parking Assist menu (example for left-hand side of the screen)

- ▶ Select the menu **Parking Assistance 2**.
- ▶ If necessary, change the direction of exit **4**.
- ▶ **To initiate the unparking procedure:** press the button **1** again.

or

- ▶ Depress the brake pedal and select **Start Unparking Procedure 3** (depending on the respective vehicle equipment).

- ▶ If necessary, change the transmission position. Observe any messages displayed on the driver display and central display. The vehicle moves out of the parking space. The duration of the unparking procedure is indicated by a progress bar.

The turn signal indicator is automatically switched on when the unparking procedure is initiated, and automatically switched off again when it is completed. You are responsible for selecting the turn signal indicator in accordance with the traffic conditions. If necessary, select the turn signal indicator accordingly.

After the parking space has been exited, a warning tone and the  **Active Parking Assist Finished: Take Control of Vehicle** message prompt you to take control of the vehicle. You have to accelerate, brake, steer and change gear yourself again.

If you do not react to the prompt to reassume control of the vehicle, the system will brake the vehicle to a standstill.

■ Pausing Active Parking Assist

You can interrupt the parking or unparking procedure of Active Parking Assist by performing one of the following actions, for example:

- ▶ Depress the brake pedal.
- ▶ Open the front passenger door, a rear door, the trunk or the hood.
- ▶ Apply the electric parking brake or activate the HOLD function.
- ▶ **To resume the parking or unparking procedure:** gently depress the accelerator pedal.

- ⓘ If the electric parking brake was applied before Active Parking Assist was activated, depress the accelerator pedal gently to start the parking or unparking procedure.

Check the area around your vehicle again before resuming a paused parking procedure. Ensure that persons, animals or objects are no longer in the maneuvering range. Observe also the system limits of Active Parking Assist.

■ Automatic braking function of Active Parking Assist

Persons or objects detected in the vehicle's path may trigger a sudden braking action, which will in turn halt the parking or unparking procedure. The vehicle will then remain at a standstill. The parking or unparking procedure is resumed if you depress the accelerator pedal.

Check the area around your vehicle again before resuming the parking or unparking procedure. Ensure once again that no persons, animals or objects are in the vehicle's path. Observe also the system limits of Active Parking Assist.

Maneuvering assistance

■ Function of Drive Away Assist

Drive Away Assist can reduce the severity of an impact when you are pulling away. If the system detects an obstacle in the direction of travel, the vehicle's speed will briefly be restricted to approximately 1 mph (2 km/h). When a critical situation is detected, the  symbol will appear on the central display.

Drive Away Assist can be switched on or off on the **Maneuvering Assistance** menu.

- ① You can cancel intervention by Drive Away Assist at any time by deactivating Parking Assist PARKTRONIC.

⚠ WARNING Risk of accident caused by limited detection performance of Drive Away Assist

Drive Away Assist cannot always clearly identify objects and traffic situations.

- ▶ Always pay careful attention to the traffic situation; do not rely on Drive Away Assist alone.
- ▶ Be prepared to brake or swerve as necessary, provided the traffic situation permits and that it is safe to take evasive action.

Drive Away Assist serves solely as an aid. It is not a substitute for you having to pay attention to your surroundings. The responsibility for safe maneuvering, parking and exiting parking spaces

remains with you. Ensure that no persons, animals or objects etc. are in the vehicle's path.

A risk of collision may arise in the following situations, for example:

- If the driver mixes up the accelerator and brake pedals.
- If an incorrect transmission position is engaged.

The Drive Away Assist function will be active in the following circumstances:

- If Parking Assist PARKTRONIC is activated.
- If you shift the transmission position to **R** or **D** when the vehicle is at a standstill.
- If the detected obstacle is less than approximately 3.3 ft (1.0 m) away.
- Maneuvering assistant is activated (→ page 225).

System limits

The performance of Drive Away Assist will be limited on uphill gradients.

- ① Also observe the system limits of Parking Assist PARKTRONIC (→ page 214).

Function of Cross Traffic Alert

- ① The Cross Traffic Alert function is available only for vehicles with Blind Spot Assist.

The Cross Traffic Alert function can warn drivers of any crossing traffic when they are backing up and maneuvering out of a parking space. The radar sensors in the bumper also monitor the area adjacent to the vehicle. If a critical situation is detected, the symbol  appears on the central display, and the vehicle can be braked automatically.

If the radar sensors are obstructed by vehicles or other objects, detection is not possible.

The Cross Traffic Alert function is active under the following conditions:

- If the vehicle is backing up at walking pace.
- Maneuvering assistant is activated (→ page 225).
- ① Observe also the instructions on Blind Spot Assist (→ page 202).

System limits

The Cross Traffic Alert function is not available on uphill gradients.

Function of close-range braking



Close-range braking can prevent collisions with pedestrians when the vehicle is backing up at slow speeds. If the rear view camera detects a person in the vehicle's path, the vehicle can be braked to a standstill.

Close-range braking can intervene under the following conditions:

- The vehicle is backing up at a speed slower than 6 mph (10 km/h).
- The camera image is shown on the central display (→ page 214).

Depending on the respective country, close-range braking can be deactivated or activated in the **Maneuvering Assistance** menu (→ page 225).

When close-range braking is triggered, the symbol  appears in red in the selected view in the menu **Camera & Parking**.

-  If close-range braking is not available, the symbol  appears in gray.

Close-range braking serves solely as an aid. It is not a substitute for you having to pay attention to your surroundings. The responsibility for safe maneuvering, parking and exiting parking spaces remains with you. Ensure that no persons, animals, objects, etc. are in the vehicle's path.

 **WARNING** Risk of accident caused by limited detection by the maneuvering brake function

The maneuvering brake function cannot always clearly detect people. Other obstacles are not detected by the function.

In these cases, the function may brake unnecessarily or not brake at all.

- ▶ Always pay careful attention to the traffic situation; do not rely on the maneuvering brake function alone.
- ▶ Be ready to brake.

System limits

Observe the system limits of the following functions:

- Active Parking Assist (→ page 218)
- 360° camera (→ page 210)
- Rear view camera (→ page 206)



The close-range braking function is not available in the following situations:

- on uphill gradients

Activating/deactivating the maneuvering assistant

Multimedia system:

  **Settings**  **Assistance**
 **Parking**

-  This function is an on-demand feature (→ page 25).
 -  The Activating/deactivating maneuvering assistant function is not available in all countries.
-  Select **Maneuvering Assistance**.

226 Driving and parking

- ▶ Activate or deactivate the desired maneuvering assistant.

Vehicle towing instructions

The vehicle is not suitable for the use of tow bar systems that are used for flat towing or dinghy towing, for example. Attaching and using tow bar systems may result in damage to the vehicle. When you are towing a vehicle with tow bar systems, safe driving characteristics cannot be guaranteed for the towing vehicle or the towed vehicle. The vehicle-trailer combination may swerve from side to side.

Observe the following information:

- Permitted towing methods (→ page 313)
- The notes on towing the vehicle with both axles on the ground (→ page 314)

Notes on the driver display

⚠ WARNING Risk of accident if the driver display malfunctions

if the driver display is inoperative or its functions are restricted, you will not receive information about such issues as other function restrictions, speed, current drive range and the status of the electric parking brake.

This will impair operating safety.

- ▶ Stop the vehicle immediately in accordance with the traffic conditions and switch it off. Do not continue driving.
- ▶ Consult a qualified specialist workshop.
- ▶ Have the vehicle transported rather than towed.

! NOTE Mercedes-AMG vehicles

- ▶ Observe the notes in the Supplement. You could otherwise fail to recognize dangers.

If the operating safety of your vehicle is impaired, park the vehicle immediately and safely. Contact a qualified specialist workshop.

The driver display shows the following basic information:

- Speed and engine speed
- Fuel level and coolant temperature
- Indicator and warning lamps

Additional functions available include the following:

- Various menus, such as **Assistance** and **Navigation**
- Status displays for the driving systems
- Display messages
- Information on speed, **Consumption** and **Range**

Some menu content and settings can be changed.

Driver display malfunction

⚠ WARNING Risk of accident if the driver display malfunctions

if the driver display is inoperative or its functions are restricted, you will not receive information about such issues as other function restrictions, speed, current drive range and the status of the electric parking brake.

This will impair operating safety.

- ▶ Stop the vehicle immediately in accordance with the traffic conditions and switch it off. Do not continue driving.
- ▶ Consult a qualified specialist workshop.
- ▶ Have the vehicle transported rather than towed.

Identifying a driver display malfunction

A driver display malfunction can be identified by characteristics such as the following:

- When the vehicle is switched on, the driver display continues to show nothing but a black screen.

- The driver display restarts.
- The content freezes.
- The display stops showing data such as speed. Various indicator and warning lamps are also displayed.

What to do in the event of a driver display malfunction

If the driver display is inoperative or its functions are restricted, stop the vehicle immediately in accordance with the traffic conditions and switch it off. The following procedure is recommended in this eventuality:

- ▶ Stop the vehicle in accordance with the traffic conditions.
- ▶ While the vehicle is stationary, continue to hold the brake pedal down.
- ▶ Press the **P** button on the DIRECT SELECT lever.
- ▶ Apply the parking brake.
- ▶ Slowly release the brake pedal and make sure that the vehicle is secured against rolling away.

- ▶ Press and hold the start/stop button (→ page 164) once for roughly three seconds to switch off the drive system.
 - ▶ Contact a qualified specialist workshop immediately.
 - ▶ Have the vehicle transported rather than towed.
- i** In addition, note the additional information about switching off the vehicle (→ page 164) and the notes on transporting the vehicle (→ page 316).

Operating the driver display

⚠ WARNING Risk of distraction from information systems and communications equipment

If you operate information systems and communication devices integrated in the vehicle when driving, you could be distracted from the traffic situation. This could also cause you to lose control of the vehicle.

- ▶ Only operate this equipment when the traffic situation permits.
- ▶ If you cannot be sure of this, stop the vehicle whilst paying attention to road and traffic conditions and operate the equipment with the vehicle stationary.

Observe the legal requirements for the country in which you are currently driving when operating the driver display.

Scrolling on the menu bar

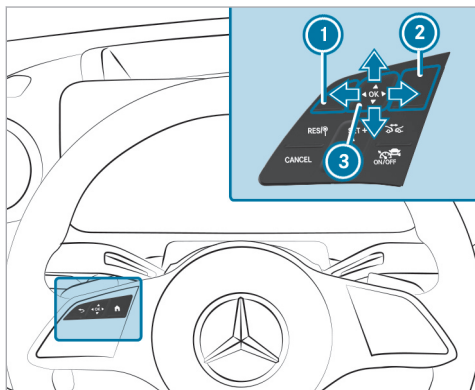

- ① Back button
- ② Main menu button
- ③ Touch Control

The controls on the left of the steering wheel manage the content of the driver display. Swipe with your finger on Touch Control ③ to navigate

vertically or horizontally through the content. Press the Touch Control to confirm your selection.

- ① To operate Touch Control ③ in the most effective way, use the tip of your thumb if possible. You can also set the sensitivity of the Touch Control on the central display.
- ▶ Briefly press main menu button ②.
- ▶ Select a menu by swiping to the left or right on Touch Control ③.
- ▶ **To confirm:** press Touch Control ③.

Driver display menus

Notes on menus on the driver display

⚠ WARNING Risk of distraction from information systems and communications equipment

If you operate information systems and communication devices integrated in the vehicle when driving, you could be distracted from the traffic situation. This could also cause you to lose control of the vehicle.

- ▶ Only operate this equipment when the traffic situation permits.
- ▶ If you cannot be sure of this, stop the vehicle whilst paying attention to road and traffic conditions and operate the equipment with the vehicle stationary.

Observe the legal requirements for the country in which you are currently driving when operating the driver display.

The following menus can be called up via the menu bar on the driver display:

- Understated
- Sport
- Classic
- Navigation
- Assistance
- Service

On some of these menus, you can choose from a range of information for the center display content.

230 Driver's display

On most of the menus, you can use **Options** to configure further settings for the menu-specific display content.

You can find further information about the possible settings and selections on the menus in the Digital Operator's Manual.

Sport menu (Mercedes-AMG vehicles)

Driver display:



The **Sport** menu displays information about the engine data, the setup and the temperature of the vehicle.

To call up the menu: swipe to the left or right on the Touch Control.

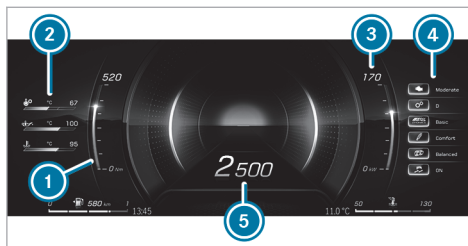

- ① Current torque
 - ② Temperature (transmission oil temperature, engine oil temperature, coolant temperature)
 - ③ Current power output
 - ④ Set-up (drive position, transmission position, AMG DYNAMICS, suspension tuning, exhaust system, ESP®)
 - ⑤ Engine speed
- i** Depending on the equipment, AMG-specific content regarding temperature, setup and engine data will be displayed. You can set the setup display content using the buttons on the multifunction steering wheel or via the MBUX multimedia system . You can also acti-

vate or deactivate ESP® using the steering-wheel button or via the MBUX multimedia system.

Head-up Display

Function of the head-up display

The head-up display projects various content into the driver's field of vision, for example.

You can use the head-up display menu bar to select different contexts, e.g.:

- Minimal
- Sport
- Standard
- ECO display (depending on model and equipment) (→ page 150)
- Settings
- Head-up display on/off

The following image shows an example of the head-up display. You can choose what content is displayed (→ page 231).

System limits

Visibility is influenced by the following conditions in particular:

- Seat position
- Image position setting
- Ambient light
- Wet road surfaces
- Objects on the display cover
- Polarization in sunglasses

Operating the head-up display

Selecting display content of the head-up display via the menu bar of the driver display

- ▶ Press the main menu button .
- ▶ **To select the menu bar of the head-up display:** swipe upwards on the Touch Control.



Switching between display content on the head-up display



- ▶ Swipe to the left or right on the Touch Control. A preview of the selected display content will appear on the head-up display.
- ▶ **To confirm:** press the  button.

Switching back to the driver display

- ▶ Press the  or  button.

Setting the position and brightness

- ▶ Swipe to the left or right on the Touch Control and select **Settings** on the menu bar of the head-up display.

- ▶ Press the Touch Control. The current position and brightness settings will be displayed as graphics on the head-up display as well as on the driver display.
- ▶ **To adjust the position:** swipe upwards or downwards on the Touch Control.
- ▶ **To adjust the brightness:** swipe to the left or right on the Touch Control. The settings configured for position and brightness will be saved automatically.
- ▶ Press the  or  button to exit the settings.

Switching the head-up display on/off

Driver display:



Switching on

- ▶ Swipe upwards on the Touch Control.
- ▶ Press Touch Control .

Switching off

- ▶ Swipe upwards on the Touch Control.

- ▶ Swipe on the Touch Control and select **Head-up Display**.
- ▶ Press Touch Control **OK**.

Setting the head-up display in the multimedia system

Multimedia system:



Switching the head-up display on/off

- ▶ Select **Head-up Display**.
The head-up display is activated or deactivated.

Vehicles with a 48 V on-board electrical system

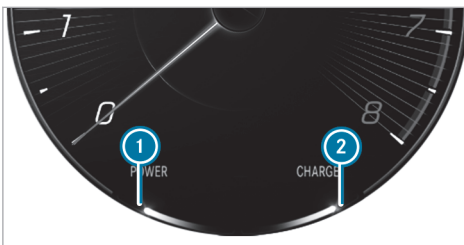







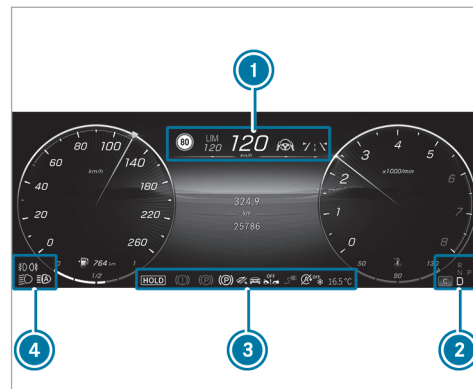







- ① Electric drive support
- ② Recuperation behavior of the electric motor
- ⓘ Due to various system limits, the values displayed may temporarily differ slightly from the actual value.

Overview of status indicators on the driver display

The status indicators for the driving and driving safety systems are shown in areas ① and ④.



- ⓐ Active Parking Assist is available (→ page 220)
- ⓑ Active Parking Assist has detected a parking space (→ page 220)
- ⓒ Parking Assist PARKTRONIC deactivated (→ page 217)
- ⓓ Cruise control (→ page 181)

-  Active Distance Assist DISTRONIC (→ page 183)
-  Specified distance for Active Distance Assist DISTRONIC (→ page 183)
-  Active Brake Assist switched off (→ page 198)
-  Active Brake Assist impaired or not functioning (→ page 198)
-  Active Steering Assist (→ page 190)
-  Active Lane Keeping Assist (→ page 204)
-  Active Blind Spot Assist (on assistant display only) (→ page 202)
-  Blind Spot Assist (on assistant display only) (→ page 202)
-  Plug-in hybrid operation activated
-  Haptic accelerator pedal (→ page 151)
-  ECO start/stop function (→ page 149)
-  HOLD function (→ page 177)
-  Adaptive Highbeam Assist (→ page 128)
-  Active Stop-and-Go Assist
-  Slippery road surface warning

Vehicles with Traffic Sign Assist: detected instructions and traffic signs (→ page 198)

Important information from other driving systems may briefly appear in front of the displayed traffic signs.

Overview and operation

Notes on the MBUX multimedia system

⚠ WARNING Risk of distraction from information systems and communications equipment

If you operate information systems and communication devices integrated in the vehicle when driving, you could be distracted from the traffic situation. This could also cause you to lose control of the vehicle.

- ▶ Only operate this equipment when the traffic situation permits.
- ▶ If you cannot be sure of this, stop the vehicle whilst paying attention to road and traffic conditions and operate the equipment with the vehicle stationary.

You must observe the legal requirements for the country in which you are currently driving when operating the multimedia system. Depending on the equipment, the scope of function and product designation of your MBUX multimedia system may differ from the description and

images in this Operator's Manual. For example, route guidance with augmented reality is not available in all equipment variants.

ⓘ The functions of your MBUX multimedia system may differ and depend on the following factors:

- Market
- National version
- Technical conditions

Functions, services and service aspects provided by Mercedes-Benz and/or third-party providers may no longer be available when the contractual period expires or due to technical conditions. There is therefore no entitlement to the continuous provision of functions and services.

The described functions may be modified, optimized and adapted after the time of going to press.

Mercedes-Benz therefore reserves the right to introduce changes in the following areas:

- Features

- Services
- Service aspects

For these reasons, descriptions and depictions relating to the MBUX multimedia system may, in some cases, differ for your vehicle.

! NOTE Increased surface temperature due to direct sunlight on the central display

The surface of the central display is very dark. If the display is exposed to direct sunlight, the surface can become very hot.

- ▶ If the central display has been exposed to direct sunlight, allow it to cool down before touching it for a long time.

Overview of the MBUX multimedia system

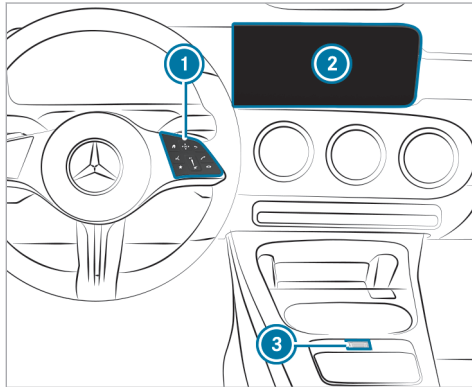

- ① Touch Control and control panel for the MBUX multimedia system
MBUX stands for Mercedes-Benz User Experience.
 - Operating Touch Control
- ② Media display with touch functionality
 - Home screen overview

- Operating the touchscreen
- ③ Controller
 - Press and hold: switches the MBUX multimedia system or media display on or off
 - Press briefly: switches the mute function on/off
 - Turn: adjusts the volume

Further operating options:

- Conducting a dialog with the MBUX Voice Assistant.
 - Operating functions contact-free with the MBUX Interior Assistant.
- ① You can find further information about operation as well as about applications and services in the Digital Operator's Manual.

Anti-theft protection

This device is equipped with technical provisions to protect it against theft. Further information on anti-theft protection can be obtained at an authorized Mercedes-Benz Center.

Home screen overview

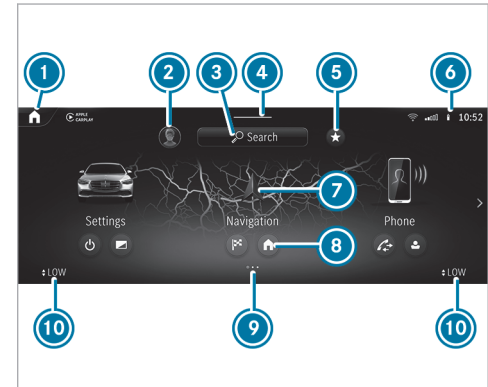

- ① On the home screen: displays the first three applications
In other displays: calls up the home screen
- ② Calls up user profile settings and switches user
- ③ Uses the global search
- ④ Calls up the Control Center: pull the bar down

- ⑤ Calls up favorites
- ⑥ Displays in the status line
- ⑦ Calls up applications
- ⑧ Quick-access to application
- ⑨ Index points for selected display area
- ⑩ Calls up the air conditioning menu

The following functions are called up in the Control Center:

- Notifications Center
- Favorites
- Vehicle quick-access

Operating the MBUX multimedia system

Using Touch Control

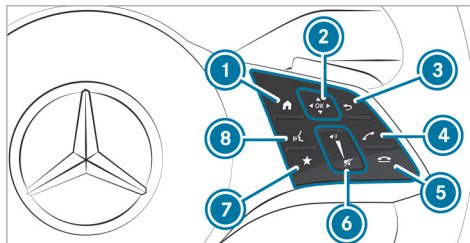

- ① Shows the home screen
- ② Touch Control
 - swipe in the direction of the arrow (navigate)
 - Press (confirm)
- ③ Returns to the previous display
- ④ Makes or accepts a call
- ⑤ Rejects or ends a call
- ⑥ To increase volume: swipe upwards
To reduce volume: swipe down

To switch off the sound: press

⑦ Calls up favorites

⑧ Starts the MBUX Voice Assistant

i To operate Touch Control ② in the most effective way, use the tip of your thumb if possible.

You can navigate through menus and lists via the touch-sensitive surface of Touch Control ② using a **single-finger swipe**, e.g.:

- ▶ **To enter a character:** select a character using the keyboard and press on Touch Control ②.
- ▶ **To select a menu option:** scroll in a list and press Touch Control ②.
- ▶ **To move the digital map:** swipe in any direction.

Using the touchscreen

- ▶ **To select a menu item or entry:** tap on a symbol or an entry.
- ▶ **To increase the map scale:** tap twice quickly with one finger.
- ▶ **To reduce the map scale:** tap with two fingers.

- ▶ **To enter characters with the keypad:** tap on a button.
- ▶ **To navigate in menus:** swipe up, down, left or right.
- ▶ **To use handwriting to enter characters:** write the character with one finger on the touchscreen.
- ▶ **To zoom in and out of the map:** move two fingers together or apart.
- ▶ **To enlarge or reduce the size of a section of a website:** move two fingers together or apart.
- ▶ **To turn the digital map:** turn counter-clockwise or clockwise using two fingers.
- ▶ **To move the digital map:** touch the touchscreen and move your finger in any direction.
- ▶ **To save the destination in the digital map:** touch the touchscreen and hold until a message is shown.
- ▶ **To set the volume on a scale:** touch the touchscreen and move your finger to the left or right.

- ▶ **To call up a global menu in the applications:** touch the touchscreen and hold until the **Options** menu appears.

On the lower control panel of the center console



- ① Turn: adjusts the volume
Press: switches sound on or off
- ▶ Select one of the functions.

Function of the MBUX Voice Assistant

⚠ WARNING Risk of distraction from information systems and communications equipment

If you operate information systems and communication devices integrated in the vehicle when driving, you could be distracted from the traffic situation. This could also cause you to lose control of the vehicle.

- ▶ Only operate this equipment when the traffic situation permits.
- ▶ If you cannot be sure of this, stop the vehicle whilst paying attention to road and traffic conditions and operate the equipment with the vehicle stationary.

For your own safety, always observe the following points when operating mobile communications equipment and especially your voice control system:

- Observe the legal requirements for the country in which you are driving.

- If you use the voice control system in an emergency your voice can change and your telephone call, e.g. an emergency call, can thereby be delayed.
- Familiarize yourself with the voice control system functions before starting the journey.

Using the MBUX Voice Assistant, vehicle functions and various areas of the MBUX multimedia system can be operated by voice input. The MBUX Voice Assistant is operational approximately half a minute after switching on the vehicle and can be operated from all seats. Further information and examples of voice commands can be found in the Digital Operator's Manual.

You can use the MBUX Voice Assistant to operate the following functions depending on the vehicle equipment:

- Telephone
- Text messages and e-mails
- Navigation
- Radio and media
- Vehicle functions
- Online functions

Full functionality of the voice control system is only available for you with activation of online voice control.

Conducting a dialog

Starting a dialog

- ▶ Say "Hey Mercedes" to activate the MBUX Voice Assistant. Voice activation must be switched on in the multimedia system.

or

- ▶ Press the  button on the multifunction steering wheel. A blue line appears in the MBUX multimedia system. The dialog can be started.

For the dialog with the MBUX Voice Assistant, you can use complete sentences of colloquial language as voice commands. Voice activation can also be directly combined with a voice command, e.g. "Hey Mercedes, how fast can I drive?"

Calling up help

- ▶ For information about the MBUX Voice Assistant: say "Hey Mercedes, what can you do?"

- ▶ **Digital Operator's Manual:** "Show me the Operator's Manual". The full extent of the Digital Operator's Manual is available when the vehicle is stationary.

Operating functions (examples)

- ▶ **To operate the navigation:** "Search for an Asian restaurant, but not Japanese, in South Manhattan."
- ▶ **To operate the phone:** "Call my father."
- ▶ **To change the system language to English (short command):** "Change language to English".
- ▶ **To operate the radio:** "Show me the list of radio stations."
- ▶ **To operate media:** "Switch on random playback."
- ▶ **To operate vehicle functions:** "Switch the seat heating to level 2."
- ▶ **To operate online functions:** "What's the time in Sydney?"
- ▶ **To ask a question about the vehicle:** "Do I have Blind Spot Assist?"

Overview of the MBUX Interior Assistant

⚠ WARNING Risk of injury from the camera's laser radiation

This product uses a classification 1 laser system. If the housing is opened or damaged, laser radiation may damage your retina.

- ▶ Do not open the housing.
- ▶ Always have maintenance work and repairs carried out by a qualified specialist workshop.

This product complies with the requirements of the FDA 21 CFR 1040.10 and 1040.11 with exception of the variations according to the FDA Laser Notice No. 50 from 24 June 2007.

The camera is located in the overhead control panel.

If the vehicle is equipped with the MBUX Interior Assistant, selected functions of the multimedia

system can be operated contact-free. In addition, the reading light or search light can be switched on or off contact-free.

The MBUX Interior Assistant can differentiate between driver and front passenger interactions. The MBUX Interior Assistant recognizes specific hand movements and a pose.

System limits, display messages and notes for rectification

The system may be impaired or may not function in the following situations:

- The camera in the overhead control panel may heat up due to operating conditions. As a result the camera may switch off temporarily, particularly during longer periods of operation and at high outside temperatures.

Do not touch or cover the camera and wait until the camera has cooled down and is available again.

- The camera is covered, dirty, fogged up or scratched.

Wait until the camera has cooled down before cleaning the camera lens.

Clean the outside of the camera lens with a dry or damp cotton cloth. Do not use micro-fiber cloths. Do **not** remove the cover when cleaning.

- Recognition can be impaired by reflective clothing, an adverse color of clothing or by accessories, for example.
- Clothing being worn (hat, shawl, scarf) may be limiting the detection range of the camera. Keep the camera's field of vision clear.
- The camera is not operational. Consult an authorized Mercedes-Benz Center.

The MBUX Interior Assistant supports the following interactions:

Interaction area	Interaction	Description
In front of the media display or above the touchpad	Proximity to the control element	The Interior Assistant recognizes the approach of your hand towards a control element. Depending on the active application, the display will be adjusted in the media display. Some functions differentiate between driver and front passenger. No specific hand position is required.
Above the center console	Defined pose	A favorite is called up with a defined pose.
Below the inside rearview mirror	Brief up and down movements	With brief up and down movements below the inside rearview mirror the reading light for the driver or the front passenger is switched on or off.
Above the front passenger seat	Stretching out a hand above the front passenger seat	By stretching out a hand above the front passenger seat the search light is switched on. If you withdraw a hand from this area, the search light is switched off again.

Switching the reading light and search light and on or off

Requirements

- **For the reading light:**
 - The function is available when it is dark.
- **For the search light:**
 - The hand movement takes place in the interaction area below the inside rearview mirror.
 - The function is available when it is dark.
 - The hand movement takes place in the interaction area above the front passenger seat.
 - The seat belt on the front passenger seat must **not** be inserted in the seat belt buckle.

Switching the reading light on and off



- ▶ Briefly move a hand up or down beneath the inside rearview mirror. The reading light is switched on or off for the driver or the front passenger.

Switching the search light on and off



- ▶ **To switch on:** reach across the front passenger seat with a hand. The search light is switched on for the driver.
- ▶ **To switch off:** take a hand back away from the front passenger seat. The search light is switched off again.

Information on users, suggestions and favorites

⚠ WARNING Risk of becoming trapped during adjustment of the driver's seat after calling up a driver profile

Selecting a user profile may trigger an adjustment of the driver's seat to the position saved under the user profile. You or other vehicle occupants could be injured in the process.

- ▶ Make sure that when the position of driver's seat is being adjusted using the multimedia system, no people or body parts are in the seat's range of movement.

If there is a risk of someone becoming trapped, immediately stop the adjustment process by:

- ▶ a) Pressing the warning message on the central display.

or

- ▶ b) Pressing a position button of the memory function or a seat adjustment switch in the driver's door. The adjustment process is stopped.

The driver's seat is equipped with an anti-entrapment feature.

If the driver's door is open, the driver's seat will **not** be set after calling up the driver's profile.

User profiles and user-specific content

Prerequisites for the vehicle owner:

- You have a Mercedes me user account.
 - You have a Mercedes me PIN.
 - You have agreed to the terms of use.
 - The vehicle is linked to a Mercedes me user account.
- i** If one of the pre-requisites listed is missing or if no user profile has been selected, the data described in the following section will be saved in the vehicle as the standard setting. Standard settings can be changed by all vehicle users.

User profiles save personal settings. If the vehicle is used by several people, a person can change their profile settings without changing the settings of other users.

You can individualize a user profile in the vehicle using the set-up assistant or using the settings in your user profile. Some settings, e.g. the Mercedes me PIN and a profile photo are made in the Mercedes me App or in the Mercedes me Portal.

User-specific content and applications with personal data are protected by different levels of security. To access protected content, the Mercedes me PIN and, depending on the vehicle equipment, biometric sensors can be used.

- i** The security level is set by the multimedia system and calculated from the combination of all sensor inputs. Some security levels cannot be turned off.
- i** When a user profile is activated, the following personalized comfort systems, for example, can be adjusted or their settings loaded:
- Seat
 - Ambient light
 - Outside mirrors
 - Roller sunblinds
 - Climate control settings

If the user profile is activated when driving, the driver's seat position will not be adjusted.

Depending on the vehicle equipment you can, as a user, save the following settings, for example:

- Driver's seat, steering wheel and mirror settings
- Climate control
- Ambient lighting
- Radio (including station list)
- Suggestions and favorites

Suggestions

The vehicle can learn the habits of the driver. It then makes suggestions regarding navigation destinations, phone numbers and music preferences. The requirements for that are the selection of a user, your consent to the recording of data and sufficient collected data.

Favorites

Favorites offer you quick access to frequently used applications. 100 favorites are available in total.

Configuring users, suggestions and favorites

Requirements:

- The vehicle is stationary.

Multimedia system:



Adding a user

- ▶ Select **+** **Add User** .
A QR code is loaded.
- ▶ Scan the displayed QR code with the Mercedes me App or any QR code scanner on a mobile device. If the Mercedes me App is not yet installed on your mobile device, you will be directed to the store of your mobile device.
- ▶ Follow the directions in the app.
The vehicle is connected with your Mercedes me user account. This automatically creates your user profile in the vehicle.
You will be informed when your user profile is available.

When the vehicle is stationary, the set-up assistant starts automatically after user selection.

Protecting user-specific content and applications

If you add a new user, access protection is already activated for the user profile. The Mercedes me PIN and, depending on the vehicle equipment, biometric sensors are available for access. Biometric sensors in the vehicle must be taught in. The authentication process then takes all taught-in and available sensors into account.

The following user-specific content and applications are protected, for example:

- User selection and user profile settings
- Biometric sensors
The teaching-in of biometric sensors is protected.
- Suggestions
The data and determination of the most probable navigation destinations, media sources, radio stations, contacts and messages are protected.
- ENERGIZING COACH

The recorded health data and their evaluation are protected.

- Mercedes me connect store
The purchase of services is protected.
- ▶ Switch **Protect Content** on or off.
- ▶ Switch **Access Protection** on or off.
- ⓘ When access protection is switched off, your user profile can be viewed from any seat and changes can be made.
- ⓘ Access protection is switched on or off on a vehicle-specific basis.

Setting up, editing and deleting biometric recognition

The biometric data models are saved in the sensors in the vehicle. If recognition has been taught-in, this sensor serves as a contributory factor for authentication on the multimedia system.

- ▶ Select **Protect Content**.
- ▶ Select **Voice Recognition**.
- ⓘ If necessary, authenticate yourself on the multimedia system.

Setting up voice recognition

- ▶ Speak the sentence shown on the media display and follow the voice assistant's instructions. If voice recognition was successful, a message appears on the media display. You can unlock your user profile.
- ⓘ Avoid background or disturbing noises during voice recognition.

Deleting biometric data



- ▶ Tap on  behind **Voice Recognition**.
- ▶ Select **Yes**.

Selecting a user

- ⓘ When you call up your driver profile, the driver's seat and the steering wheel can be set. You can cancel the setting process with the following actions:
 - Tap on the **Tap Here to Cancel** message on the media display.
 - Press one of the seat operating buttons in the driver's door.

- ▶ Select **Select User**.
- ▶ Select a user.
- ▶ When requested to do so, authenticate with the Mercedes me PIN or a taught-in biometric characteristic. The user profile is loaded and activated.
- ⓘ If you select **Continue Without Selecting a User**, no specific settings for the user profile are loaded.





Configuring and deleting suggestions

- ▶ Select .
- ▶ Select **Settings**.
- ▶ Select **System**.
- ▶ Select **Suggestions**.
- ▶ Select .
- ▶ Switch the options on or off individually. If an option is switched on and sufficient data has been gathered, personalized suggestions based on your user behavior will be offered to you on the zero layer. These are, for example, navigation destinations visited, phone num-

bers dialed as well as suggestions based on your music preferences.

- ▶ **To delete collected suggestions:** select .
- ▶ Select **Yes**. The suggestions are reset.

Adding favorites from categories

- ▶ Select .
- ▶ Select .
- ▶ Select .
- ▶ Select  **Create New Favorite**.
- ▶ Select the category.
- ▶ Select a favorite.

System settings

Overview of the system settings menu

In the system settings menu, you can make settings in the following menus and control elements:

- Display
 - Display brightness

- Control elements
 - Keyboard language and handwriting recognition
 - Sensitivity of Touch Control
 - Haptic operation for the touchscreen
- MBUX Voice Assistant
- MBUX Interior Assistant
- Sound
 - Entertainment
 - Navigation and traffic announcements
 - Telephone
- Data protection
- Connectivity
 - Wi-Fi, Bluetooth®, NFC
- Time & date
- Language
- Units for distance
- System PIN
- Suggestions
- Software update

- System reset

Overview of software updates

Important software updates may be necessary for the security of your multimedia system's data. Install these updates, or else the security of your multimedia system cannot be ensured.

The multimedia system displays a corresponding message when a software update is available.

If the **Automatic Online Update** option is active, software updates are downloaded automatically. If the option is deactivated, you will be informed of new software updates once. The software updates are available for downloading for a limited period of time.

Carrying out a software update:

- You can start software updates via the communication module.
- You can start software updates via a WLAN hotspot.
- You can start map updates from an external medium.

- ❗ Online software updates cannot be performed via external WLAN hotspots that are encrypted via TKIP.
- ❗ If the WLAN hotspot requires logging in via the browser, once the connection is successfully established the browser will open in order to start the update. To start the download follow the instructions in the browser.
- ❗ To complete software updates via the communication module, the vehicle must be connected with the Internet and a Mercedes me user account.
- ❗ To complete software updates via WLAN, the vehicle must be connected to an external WLAN hotspot.

A software update consists of three steps:

- Downloading or copying of the data required for installation
- Installation of the downloaded software update
- Activation of the downloaded software update

- ❗ It may be necessary to restart the MBUX multimedia system after completion of a software update.
- ❗ While some software updates are being downloaded, the multimedia system cannot be operated and the vehicle functions may be restricted.
- ❗ Some software updates require a safe vehicle status for the installation to be completed. They can only be carried out in a safely parked vehicle with the vehicle switched off.

For software updates requiring a safe vehicle status: when the last installation step is reached, a message appears on the media display after the vehicle is switched off. Follow the step-by-step instructions on the media display to complete the installation.

There are software updates that can only be installed when the vehicle is safely parked, there are no more people in the vehicle and the vehicle is locked.

Availability of the driver and media display

During the installation of software updates, it is not possible to use the vehicle, media display and

driver display. You may receive the following display message when an installation is running:

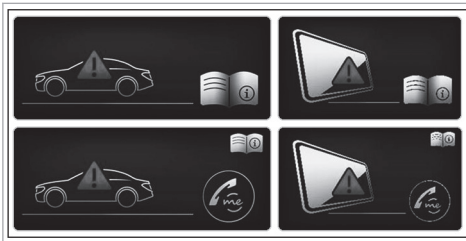

- ❗ The display message does not appear every time a software update is installed.

In rare cases, an error can occur during the installation. The multimedia system automatically attempts to restore the previous version.

If it is not possible to restore the previous version, the display message shown above appears every time the vehicle is started.

Failure of the driver display

If the driver display fails or there is a malfunction, you may not recognize limitations in the functions

of systems relevant to safety or the speed display, for example. This may impair the operating safety of the vehicle. Park the vehicle safely as soon as possible and notify a qualified specialist workshop. (→ page 374)

Further information about software updates can be found at <https://me.secure.mercedes-benz.com>

Failure of the media display

If the media display fails or the display message shown above is shown continuously, several systems such as the rear view camera, Parking Assist PARKTRONIC or climate control are no longer available. Drive on carefully and consult a specialist workshop as soon as possible.

Setting up a Wi-Fi hotspot

Requirements:

- The Wi-Fi function is activated on the multimedia system and the communication device to be connected.

- The communication device to be connected supports at least one of the types of connection described.

The connection types shown depend on the device to be connected. The function must be supported by the multimedia system and by the device to be connected. The type of connection must be selected on the multimedia system and on the device to be connected.

- ⓘ Some functions may first need to be activated on the communication device being connected. More detailed information can be found in the manufacturer's operating instructions.
- ⓘ The use of the vehicle data tariff by external devices is not available in all countries.

Multimedia system:

→  » Settings » System
» Internet and Bluetooth

- ⓘ The availability of the functions is country-dependent.
- ▶ Select **Wi-Fi**.
The controller is to the right: Wi-Fi is switched on.

When the Wi-Fi function is switched on, you can connect the multimedia system with external hotspots or make it available as a hotspot for external devices.

When the Wi-Fi function is switched off, it is not possible to establish a hotspot connection.

- ⓘ Depending on the vehicle equipment, you can obtain an Entertainment Package via the Mercedes me Store. In order to use the data package included, you must conclude your own contract with a mobile phone network provider via the Mercedes me App. This can be terminated at any time and incurs no costs. Without this contract it is not possible to use the services included in the previously acquired Entertainment Package. The availability of this option is dependent on the country. If the data package option is not available or can be upgraded, you can purchase data volume directly from the mobile phone network provider for a fee. The availability of this option is dependent on the country.
- ⓘ The use of the vehicle data tariff by external devices is not available in all countries.

Using the multimedia system as a Wi-Fi hotspot

- ▶ Select **MBUX Hotspot**.
- ▶ Select one of the following connection options.

Connecting using a QR code

Requirement: an app for scanning the QR code is installed on the device being connected.

Alternatively: the device being connected has an integrated QR code scanner (see the manufacturer's operating instructions).

- ▶ Scan the QR code shown.
The WLAN connection is established.

Connecting using NFC

- ▶ Activate NFC on the device to be connected.
- ▶ When the NFC symbol is displayed in the **MBUX Hotspot** menu, hold the device to be connected to the NFC interface.
- ▶ Follow the instructions on the device.
The WLAN connection is established.

Connecting using a security key

- ▶ Select the vehicle from the device to be connected. The vehicle is displayed with the **MBUX XXXXX** network name.
- ▶ Enter the security key shown on the device to be connected.
- ▶ Confirm the entry.

Generating a new security key

- ▶ Select the **Generate New Security Key** option in the **MBUX Hotspot** menu.
- ▶ Confirm the prompt with **Yes**.
A new security key is generated.

A connection will be established with the newly created security key.

- ⓘ When a new security key is generated, all existing Wi-Fi connections are then disconnected. If the WLAN connections are re-established, the new security key must be entered.

Using a mobile communication device as a Wi-Fi hotspot (tethering)

- ⓘ This function is country-dependent.
 - ▶ Select the **Manage Internet Access** option in the **Internet and Bluetooth** menu.
 - ⓘ The Wi-Fi function on the mobile phone and Internet access via Wi-Fi must be activated (see the manufacturer's operating instructions).
 - ▶ Select **Search for Access**.
 - ▶ Select the network.
 - ▶ Log in to the Wi-Fi network.
- or
- ▶ Select the mobile phone with the  Wi-Fi symbol.

- ⓘ With external Wi-Fi hotspots, which are encrypted via TKIP, online software updates cannot be carried out via the external Wi-Fi hotspot.

System language

Notes on the system language

This function allows you to determine the language for the menus and navigation announcements. The selected language affects the characters available for entry. The navigation announcements are not available in all languages. If a language is not available, the navigation announcements will be in English.

Setting the language

Multimedia system:

- ▶  **Settings** ▶ **System**
▶ **Language**

Setting the system language

A list of the available system languages is shown.

- ▶ Select a language.
The system language is switched to the selected language.

Resetting the multimedia system (reset function)

⚠ WARNING Risk of accident due to failure of central display functions

While the multimedia system is reset, its functions, such as the rear view camera, are not available.

▶ Only reset the multimedia system when the vehicle is stationary.

Requirements:

- The vehicle is switched on.
- The vehicle is stationary.

Multimedia system:

➔  ▶▶ Settings ▶▶ System ▶▶ Reset

When resetting the system, personal data and settings are deleted, for example:

- Connected devices
- Individual user profiles
- Biometric data

① The data used and saved in the multimedia system by the driver assistance systems is deleted.

▶ Select **Reset**.

A query appears asking if the system should really be reset.

▶ Select **Yes**.

The multimedia system is reset to the factory settings. The multimedia system is restarted after the system reset.

① Due to data protection, as well as the function of individual driving systems and driving safety systems, it is a requirement to carry out a complete system reset before selling the vehicle or transferring it to a third party, or after use as a hire car.

Navigation and traffic

Notes on navigation

Route guidance with augmented reality

⚠ WARNING Risk of accident and injury as a result of distraction, incorrect depiction or wrong interpretation of the display

The camera image of the augmented reality display is not suitable as a guide for driving.

- ▶ Always keep an eye on the actual traffic situation.
- ▶ Avoid extended observation of the camera image.

⚠ WARNING Risk of accident and injury due to imprecise positioning of additional information

The additional information from the augmented reality display may be inaccurate and is not a substitute for observing and assessing the actual driving situation.

- ▶ Always keep an eye on the actual traffic situation when carrying out all driving maneuvers.

Switching navigation on

Multimedia system:



- ▶ Alternatively, press the  button on the steering wheel on the right (→ page 236). The zero layer with the digital map is displayed.

Navigation overview

Digital map

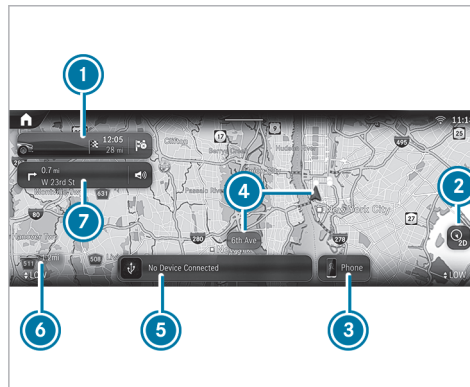

- ① Navigation module (reduced view)
Route guidance active:
The navigation module shows the information relevant to the route in the zoomed-out view, e.g. the destination or a traffic delay

-  Ends the current route guidance

Tapping opens the navigation module and displays the route overview

- ② Sets map orientation  and map type
- ③ Calls up the telephone menu
- ④ Current vehicle position (vehicle symbol or arrow)
- ⑤ Calls up entertainment applications
- ⑥ Elevation and map scale
- ⑦ Navigation window shows the next maneuver (zoomed out view) or the route monitor (zoomed in view)

Route guidance active: route monitor shows, e.g. route sections, upcoming driving maneuvers with lane recommendations, destination, traffic delays, 3D images at freeway exits, online content

Pressing ② several times changes the map orientation in this order:

- 2D and to the north
- 2D and in the direction of travel
- 3D and in the direction of travel

- Map with complete route
- ① If the map is moved, the map switches between 3D direction of travel and 2D north orientation.

The following map types ② are available:

- Daytime display
- Night-time display
- Satellite map

- ① If you notice a problem with the digital map you can report this under <https://mapfeedback.here.com/#/report>.

Navigation module (expanded view)

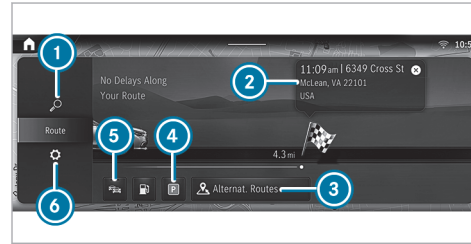

Example: route guidance is active

- ① Enters an address or POI
- ② Destination and time of arrival beneath that the current distance to the destination and the checkered flag
- ③ Alternative routes
- ④ Searches for parking
- ⑤ Switches traffic information display on or off
- ⑥ Makes settings for [View, Messages & Acoustic Signals](#) and [Route](#)

Overview of the toll system

- ① The toll system is optional equipment and is not available in all vehicles.

Debiting of toll charges at freeway toll gates is facilitated with an electronic payment system.

The toll system uses RFID (Radio Frequency Identification) for data transfer between the control unit and the toll station.

The toll system is initially switched off at the factory.

The control unit is in the vehicle glove box.

In order to be able to use the toll system, it must have been registered by the customer and activated by the service provider:

- Activate the toll system in the settings of the MBUX multimedia system or on the control unit.
- There are two ways to register and activate:
 - In the Mercedes me App, register the unit identification number of the control unit and activate the toll system.

- Alternatively, you can register and activate via the **Toll Service** app.

Activation of the toll system can take up to 48 hours after registration.

When the toll system is activated, the automatic detection of the number of vehicle occupants is initially switched off at the factory. The number of vehicle occupants is preset with one person.

The following applies for roads on which toll charges are dependent on the number of vehicle occupants:

- If the automatic detection of the number of vehicle occupants is switched off, the number of vehicle occupants must be selected manually. This ensures correct toll accounting.
- The number of vehicle occupants can be transmitted automatically. In the process, the number of seat belts worn is determined.

If the number of detected persons does not correspond with the number of persons actually in the vehicle, the number of persons must be manually selected.

The standard setting of one person does not need to be changed for roads which require toll payment regardless of the number of vehicle occupants.

The toll system enables the payment of toll charges in many states of the USA.

- ① In Mexico, for example, the toll system can be registered and activated for journeys to the USA.

Notices

- You can only use the toll system once registration and activation are complete.
- Drive at the prescribed vehicle speed in the toll lane.
- Mercedes-Benz recommends operation using the MBUX multimedia system. Alternatively, this can also be done on the control unit in the glove box.
- For safety reasons, entries should be made while the vehicle stationary.
- For further information, please consult the Mercedes me App or an authorized Mercedes-Benz Center.

Or call 1-800-FOR-MERcedes (in the USA) or 1-800-387-0100 (in Canada).

For information on how to register and activate the toll system, see the Digital Operator's Manual.

Entering a destination

Requirements:

- **For the online search:**

- There is an Internet connection.
- Mercedes me connect is available.
- You have set up a user account in the Mercedes me Portal.
- The vehicle is connected with the user account and you have accepted the terms of use.
- Further information can be found at: <https://www.mercedes.me>
- The service is available.
- The service has been activated at an authorized Mercedes-Benz Center.

- ❗ If Online Search is not available, the search is performed using the data of the digital map.

Multimedia system:

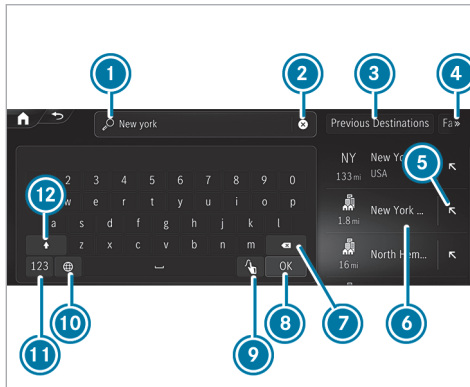

Example: entering a POI or address

- ① Input line with current entry
- ② Deletes an entry
- ③ Selects previous destinations

- ④ Displays and selects additional destination searches
- ⑤ Adopts the search result in the input line and continues the search
- ⑥ Search result
- ⑦ Deletes the last character entered
- ⑧ Hides the keypad
- ⑨ Switches to handwriting recognition
- ⑩ Sets the written language
- ⑪ Switches to digits and special characters
- ⑫ Switches to upper-case or lower-case letters

If available, selecting the  symbol starts the MBUX Voice Assistant.

- ▶ Enter the destination in ①. The entries can be made in any order. The search results are displayed in a list.

- ❗ Online search results for POIs may contain additional information, for example opening times and ratings. The information is provided by an online map service. This online function is not available in all countries.

- ❗ You can enter a destination as a three-word address from what3words. This option is not available in all countries.
- ▶ Hide the keyboard with **OK**.
- ▶ Select the destination in the list. The following menu shows the selected destination with the address information and a corresponding map section. The menu enables the route to be calculated.
- ❗ Observe the notes on the MBUX multimedia system (→ page 234).

Calculating a route and using settings for route guidance



Example: detailed display

- 1 Calls up alternative routes
- 2 Calculates the route and starts route guidance
- 3 Selects a point of interest in the vicinity of the destination
- 4 Destination address

After selection of a destination the route is be calculated.

- ▶ Select one of the options.

Calling up alternative routes

- ▶ Select **Routes**.
- ▶ Select an alternative route.

Starting route guidance

- ▶ Select **Let's Go!**.

Calling up the detailed display with destination address

- ▶ Pull the bar above upwards. Depending on the destination selection and availability, online content, for example ratings and weather information, is shown. If the destination is in a different time zone, a message is displayed.
- ▶ **To share a destination:** select **Share**. This option allows you to scan the displayed QR code.
- ▶ **To save a destination as a favorite:** select **Favorite** and then an option.
- ▶ **To call up an Internet address:** if a web address is available, select **www**.

- ▶ **To call the destination:** if a telephone number is available, select **Call**.

Searching for POIs in the vicinity of the destination shown

- ▶ Select **In The Vicinity**.
- ▶ Search using categories, enter a search entry or search for a personal POI.

Selecting a route type

- ▶ In the navigation module (expanded view), select (→ page 250).
- ▶ Select **Route**. The route is calculated as a fast route with a short journey time. Trailer mode is available if a trailer has been coupled with the vehicle. If available, you can select online routes. Traffic announcements for the route are taken into account via **Reroute Based on Traffic** .
 Trailer mode and online routes are not available in all countries and for all vehicles.

Calculating alternative routes

- ▶ In the navigation module (expanded view), select .
- ▶ Select **View**.
- ▶ Switch on **Route Overview after Start**.
Alternative routes are calculated for every route.



Selecting alternative routes

- ① If **Route Overview after Start** has been switched on and a route has been calculated, the function is available.
- ▶ In the navigation module (expanded view), select **Alternative Routes**.
- ▶ When the alternative routes have been calculated, display the route in the navigation window by swiping to the right or left.
- ▶ Select **Start**.

Activating a commuter route

- ① A user profile has been created and **Allow Destination Suggestions** has been activated

in the user options (→ page 243). Route guidance is not active.

- ▶ In the navigation module (expanded view), select .
- ▶ Select **Route**.
- ▶ Switch on **Commuter Route**.
The navigation system automatically detects that the vehicle is on a commuter route.
For the daily commuter route, traffic incidents on the route are also reported when driving without active route guidance.
- ▶ **To select or delete a commuter route:** select **Start** or .

Avoiding or using route sections, e.g. highways or ferries

- ▶ In the navigation module (expanded view), select .
- ▶ Select **Route**.
- ▶ Select **Avoid Options**.
- ▶ Activate or deactivate the avoid option.

Activating route guidance with augmented reality

- ▶ In the navigation module (expanded view), select .
- ▶ Select **View**.
- ▶ Select **Augmented Reality Video**.
- ▶ Activate or deactivate **Augmented Reality Video**.
The camera's video image is shown on the media display before a turning maneuver. The video image includes additional information.

Showing property information for route guidance with augmented reality

Route guidance with augmented reality is activated.

- ▶ In the navigation module (expanded view), select .
- ▶ Select **View**.
- ▶ Select **Augmented Reality Video**.
- ▶ Activate **Street Names** and **House Numbers**.
During route guidance, the activated options are shown as additional information in the camera image.

Using map functions

Multimedia system:



Increasing map scale

▶ When the map is shown, tap twice quickly with one finger on the media display.

or

▶ Move two fingers apart on the media display.

Decreasing map scale

▶ Tap with two fingers on the media display.

or

▶ Move two fingers together on the media display.

Moving the map

▶ When the map is displayed, swipe in any direction with one finger on the media display.

▶ **To reset the map to the current vehicle position:** select  **Center**.

Selecting map orientation

▶ Tap repeatedly on the  compass symbol on the map.

The map orientations changes in this order:

- The 2D map view is displayed so that north is always at the top.
- The 2D map view is aligned to the direction of travel.
- The 3D map view is aligned to the direction of travel.
- The map shows the complete route.

Using services

Requirements:

- There is an Internet connection.
- Mercedes me connect is available.
- You have set up a user account in the Mercedes me Portal.
- The vehicle is connected to a user account and you have accepted the conditions of use for the service.

Further information can be found at: <https://www.mercedes.me>

- The service is available.
- The service has been activated at an authorized Mercedes-Benz Center.

Multimedia system:



Showing traffic information

Route guidance uses traffic reports via Live Traffic Information.

▶ In the navigation module (expanded view), select  (→ page 250).

▶ Select **View**.

▶ Activate **Traffic**.

▶ Activate **Traffic Incidents** and **Free Flowing Traffic**.

Traffic incidents, for example roadworks, local area reports (e.g. fog) and warning messages, are shown on the route.

The traffic delay is displayed for the current route. The smallest value for the display for traffic delays is a minute.

i For more information on Live Traffic Information, please refer to the Digital Operator's Manual.

Displaying hazard warnings

If hazard warnings are available these can be shown as symbols on the map. The display depends on the settings for the **Traffic Incidents** option.

- ▶ In the navigation module (expanded view), select  (→ page 250).
- ▶ Activate or deactivate **Traffic Incidents**. If the option is activated, all of the symbols are shown.

If the option is deactivated, the symbols are only shown when there is a hazard warning.

The following hazards may be shown on the map:

- Accidents and breakdowns
- Slippery roads, fog, crosswinds and heavy rain
- Hazards reported manually
- Vehicle with active hazard warning light

- Roadworks
- Additional hazards (if available)

Displaying online map contents

- ▶ In the navigation module (expanded view), select .
- ▶ Select **View**.
- ▶ Switch on an online service, e.g. **Weather**. Current weather information is displayed on the navigation map, e.g. temperature or cloud cover. The service information is not shown in all map scales, e.g. weather symbols.

Parking service

i **NOTE** Vehicle damage due to failure to observe the maximum permissible clearance height

If the vehicle height exceeds the maximum permissible clearance height, the roof and other vehicle parts may be damaged.

- ▶ Please observe the maximum clearance height indicated.
- ▶ If the vehicle exceeds the permissible clearance height, do not drive in.
- ▶ Take the modified vehicle height into account in the case of roof superstructures or other carrier systems.

i **NOTE** Vehicle damage due to failure to observe local information and parking conditions

The data is based on the information provided by the respective service providers.

Mercedes-Benz does not guarantee the accuracy of the information provided in relation to the car park or parking area.

- ▶ Always observe the local information and conditions.

- i** This service is not available in all countries.
- ▶ In the navigation module (expanded view), select  and switch on **Parking**.

▶ Tap on **P** the map.
or

▶ In the route overview, select **P** **Parking Spaces**.

▶ Select the search position and search filter, e.g. **Near Destination** and **Parking Garages**. The map shows car parks suited to the selected settings.

▶ Select a parking option.
The map shows the parking options in the vicinity.

The following information is displayed (if available):

- Destination address, distance from current vehicle position and arrival time
- Information on the parking garage/car park

For example, opening times, parking charges, current occupancy, maximum parking time, **maximum access height**.

The maximum access height shown by the parking service does not replace the need

for observation of the actual circumstances.

- Available payment options (Mercedes pay, coins, bank notes, cards)
- Details on parking tariffs
- Number of available parking spaces
- Payment method (e.g. at parking meters)
- Services/facilities at the parking option
- Telephone number

▶ Calculate the route (→ page 254).

Notes on the dashcam

! **NOTE** Risk of legal consequences due to violation of legal regulations and data protection provisions

You are legally responsible for operation and use of the dashcam functions.

The legal requirements relating to operation and use of the dashcam can vary depending

on the country in which the dashcam is operated.

This function is not permitted in all countries.

- ▶ Before using the dashcam, read up on the content of the legal regulations, in particular the data protection requirements in the respective country of use.
- ▶ Observe the legal regulations, in particular the data protection requirements.

i Observe the following instructions for safe operation:

- Only use FAT32 or exFAT formatted USB storage devices.
- Use USB-IF certified USB storage devices.

USB-IF is a non-profit corporation and stands for USB Implementers Forum. Based on the USB specification, USB-IF certifies, for example, USB versions, corresponding cables and plugs as well as energy supply processes via the USB interface.

- USB storage devices may be damaged if often or permanently overwritten at high speed. Mercedes-Benz recommends a high-quality external SSD drive.
The abbreviation SSD stands for Solid State Drive.

i The file size and therefore the duration of single recording is limited by the limitations of the USB flash drive format. So FAT32 formatted USB flash drives do not allow files larger than 4 GB, for example.
When the file size is reached, the recording stops and you receive a notification.

- i** The following functions are available in the Gallery app:
- Switching write protection on or off
 - Deleting video files

Selecting a USB device for a video recording with the dashcam

Requirements:

- At least one USB device is connected with the multimedia system .

Multimedia system:

→  » Apps » Dashcam

- ▶ Select the USB symbol.
- ▶ Select the USB device.
- i** When USB devices contain multiple partitions, recorded video files are not always displayed in the recording list.
Mercedes-Benz recommends that you use USB devices with one partition.

Starting or stopping a loop recording with the dashcam

Requirements:

- For recording and saving a video file: a USB device is connected with the multimedia system.
- The vehicle is switched on.

Multimedia system:

→  » Apps » Dashcam

- ▶ If several USB devices are connected with the multimedia system, select a USB device (→ page 259).
If no USB device is selected, a selection is made automatically when recording starts.
- ▶ **To select recording mode:** select **Loop Recording**.
Loop Recording continuously records short video files. When the memory is full, recording is continued automatically. In doing so, the oldest video file is written over.
- ▶ **To start:** select **Start Recording**.
The length of the recording is shown. The **Do not remove the storage medium during recording. Before removing the storage medium, eject it first.** message appears. The video file is stored on the USB device.
- ▶ **To end:** select **End Recording**.
- i** In some countries, geo-coordinates (longitude and latitude) are shown in the video image.
For technical reasons, the geo-coordinates may show greater inaccuracies.

A message may appear in the following cases:

- The camera is not functional, the **Camera Unavailable** message appears.
Have the camera checked in an authorized Mercedes-Benz Center.
- If the country border indication has been switched on.
- If an outdoor recording is started with the camera app during a dashcam recording, the dashcam recording pauses and resumes automatically after the camera recording is finished. A notification to this effect is displayed.

Starting or stopping individual recordings with the dashcam

Requirements:

- For recording and saving a video file: a USB device is connected with the multimedia system.
- The vehicle is switched on.

Multimedia system:

↳  **Apps** **Dashcam**

- ▶ If several USB devices are connected with the multimedia system, select a USB device (→ page 259).
If no USB device is selected, a selection is made automatically when recording starts.
- ▶ **To select recording mode:** select **Individual Recording**.
Individual Recording stops recording when the memory limit is reached. An individual recording is automatically protected against being overwritten.
- ▶ **To start:** select **Start Recording**.
The length of the recording is shown. The **Do not remove the storage medium during recording. Before removing the storage medium, eject it first.** message appears. The video file is stored on the USB device.
- ▶ **To end:** select **End Recording**.
- ⓘ In some countries, geo-coordinates (longitude and latitude) are shown in the video image. For technical reasons, the geo-coordinates may show greater inaccuracies.

A message may appear in the following cases:

- **Individual Recording:** the memory is full or there are only a few minutes recording time available. The video recording stops or will be stopped imminently.
Change the USB device or delete a video file.
- The camera is not functional, the **Camera Unavailable** message appears.
Have the camera checked in an authorized Mercedes-Benz Center.
- If the country border indication has been switched on.
- If an outdoor recording is started with the camera app during a dashcam recording, the dashcam recording pauses and resumes automatically after the camera recording is finished. A notification to this effect is displayed.

Telephone

Telephony

Notes on telephony

- ⚠ WARNING** Risk of distraction from operating integrated communication equipment while the vehicle is in motion

If you operate communication equipment integrated in the vehicle when driving, you could be distracted from the traffic situation. This could also cause you to lose control of the vehicle.

- ▶ Only operate this equipment when the traffic situation permits.
- ▶ If you cannot be sure of this, stop the vehicle whilst paying attention to road and traffic conditions and operate the equipment with the vehicle stationary.

- ⚠ WARNING** Risk of accident from operating mobile communication equipment while the vehicle is in motion

Mobile communication devices distract the driver from the traffic situation. This can also cause the driver to lose control of the vehicle.

- ▶ As a driver, only operate mobile communication devices when the vehicle is stationary.
- ▶ As a vehicle occupant, use mobile communication devices only in the designated area, e.g. in the rear passenger compartment.

You must observe the legal requirements for the country in which you are currently driving when operating the multimedia system and mobile communication equipment in the vehicle.

- ⚠ WARNING** Risk of injury due to objects being stowed incorrectly

If objects in the vehicle interior are stowed incorrectly, they can slide or be thrown around

and hit vehicle occupants. In addition, cup holders, open stowage spaces and mobile phone receptacles cannot always retain all objects within.

There is a risk of injury, particularly in the event of sudden braking or a sudden change in direction.

- ▶ Always stow objects so that they cannot be thrown around in such situations.
- ▶ Always make sure that objects do not protrude from stowage spaces, parcel nets or stowage nets.
- ▶ Close the lockable stowage spaces before starting a journey.
- ▶ Always stow and secure heavy, hard, pointed, sharp-edged, fragile or bulky objects in the trunk/cargo compartment.

Observe the additional information on stowing mobile communications devices correctly:

- Loading the vehicle (→ page 112)

Bluetooth® connection:

The menu view and the available functions in the telephone menu are in part dependent on the Bluetooth® profile of the connected mobile phone. If the mobile phone supports all the following Bluetooth® profiles, the full range of features is available:

- PBAP (Phone Book Access Profile)
 - The contacts on the mobile phone are shown automatically on the multimedia system.
- MAP (Message Access Profile)
 - The mobile phone message functions can be used on the multimedia system.
- HFP (hands-free profile)
 - Wireless telephony is available on the multimedia system.
- SAP (SIM Access Profile)
 - The car telephone has access to the SIM card data and dials into the mobile phone network via the exterior antenna.

Irrespective of this, Bluetooth® audio functionality can be used with any mobile radio unit.

For information on the range of functions of the mobile radio unit to be connected, see the manufacturer's operating instructions.

Network connection:

The following cases can lead to the call being disconnected while the vehicle is in motion:

- You switch into a transmission/reception station, in which no communication channel is free.
- The SIM card used is not compatible with the network available
- A mobile phone with "Twincard" is logged into the network with the second SIM card at the same time

The multimedia system supports calls in HD Voice® for improved speech quality. A requirement for this is that the mobile phone and the mobile phone network provider of the person you are calling support HD Voice®.

Depending on the quality of the connection, the voice quality may fluctuate.

Further information can be obtained from an authorized Mercedes-Benz Center or at: <https://www.mercedes-benz.com/connect>.

Telephone menu overview

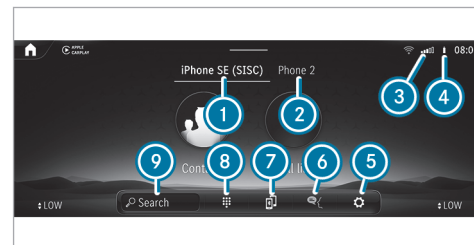

- ① Bluetooth® device name of the currently connected mobile phone/of the mobile phone
- ② Bluetooth® device name of the currently connected mobile phone/of the mobile phone (two phone mode)
- ③ Signal strength of the mobile phone network
- ④ Battery status of the connected mobile phone
- ⑤ Options
- ⑥ Messages

- 7 Calls up devices
- 8 Numerical pad
- 9 Starts contact search

Telephony operating modes overview

Depending on your equipment, the following telephony operating modes are available:

- A mobile phone is connected to the multimedia system via Bluetooth®.
- Two mobile phones are connected with the multimedia system via Bluetooth® (two phone mode).
 - You can use all the functions of the multimedia system with both mobile phones.

Connecting a mobile phone

Requirements

- Bluetooth® is activated on the mobile phone (see the manufacturer's Operator's Manual).
- Bluetooth® is activated on the multimedia system.

Multimedia system:

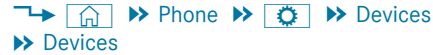

Searching for a mobile phone



- ▶ Select **Connect New Device**.

Connecting a mobile phone

- ▶ Select a mobile phone.
A code is displayed in the multimedia system and on the mobile phone.
- ▶ If both codes match, confirm the code on the mobile phone.

Functions in the telephony menu

In the telephony menu you have the following functions, for example:

- Making calls, e.g.:
 -  Accepting a call
 -  **End Call**
 - Answering a call with a message
 -  **Conference**
 - Accepting or rejecting a waiting call

- Managing contacts, e.g.:
 - Downloading mobile phone contacts
 - Managing the format of a contact's name
 - Deleting favorites
- Receiving and sending messages, e.g.:
 - Using the read-aloud function
 - Dictating a new message

Mercedes me Apps

Mercedes me calls

Making a call via the overhead control panel

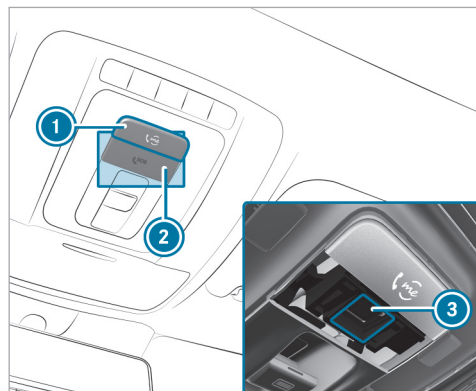

- ① me button for service or information calls
- ② SOS button cover
- ③ SOS button (emergency call system)

Making a Mercedes me call

- ▶ Press me button ①.

Making an emergency call

- ▶ To open the cover of SOS button ②, press it briefly.
- ▶ Press and hold SOS button ③ for at least one second.

If a Mercedes me call is active, an emergency call can still be triggered. This has priority over all other active calls.

Information about the Mercedes me call using the me button

A call to the Mercedes-Benz Customer Center has been initiated via the me button in the overhead control panel or the multimedia system (→ page 264).

Using the voice dialog system you access the desired service:

- Accident and Breakdown Management
- Mercedes-Benz Customer Center for general information about the vehicle

You can find information on the following topics:

- Activation of Mercedes me connect
- Operating the vehicle
- Nearest authorized Mercedes-Benz Center
- Other products and services from Mercedes-Benz

Data is transferred during the connection to the Mercedes-Benz Customer Center (→ page 266).

Calling the Mercedes-Benz Customer Center using the multimedia system

Requirements

- Access to a GSM network is available.
- The contract partner's GSM network coverage is available in the respective region.
- The vehicle must be switched on so that vehicle data can be transferred automatically.

Multimedia system:



▶ Call **Mercedes me connect**.

After confirmation, the multimedia system sends the required vehicle data. The data transfer is shown in the display.

Then you can select a service and be connected to a specialist at the Mercedes-Benz Customer Center.

■ **Calling the Mercedes-Benz Customer Center after automatic accident or breakdown detection**

Requirements:

- The vehicle has detected an accident or breakdown situation (→ page 171).
- The vehicle is stationary.
- The hazard warning lights are switched on.

❗ This function is not available in all countries.

The vehicle can detect accident or breakdown situations under certain circumstances.

Requirements for collision detection in the context of accident recovery:

- The vehicle is equipped with an anti-theft alarm system (ATA) (code 551).
- The vehicle is equipped with the interior protection (code 882).
- The vehicle is equipped with the Anti-Theft Protection Package (code P54).
- The collision detection service with theft notification has been activated on Mercedes me connect.

If a collision is detected when the tow-away alarm is armed on a locked vehicle, you will receive a notification in the multimedia system when you switch the vehicle on.

The message informs you about the potentially affected area of the vehicle and the strength of the collision.

In the event an accident or breakdown is detected, the emergency guide shows safety notes in the multimedia system display. This may take a few seconds.

❗ The availability of collision detection depends on the vehicle.

After quitting the emergency guide display on the multimedia system, a prompt appears asking whether you would like to get support from the Mercedes-Benz Customer Center.

▶ Select **Call**.

- After your agreement, or if the Mercedes me connect service "Accident and Breakdown Management" is active, the vehicle data is transferred automatically (→ page 268).
- The Mercedes-Benz Customer Center takes your call and organizes the breakdown and accident assistance.

You may be charged for these services.

❗ Depending on the severity of the accident, an automatic emergency call can be initiated. This has priority over all other active calls (→ page 272).

- ❗ In addition, if the Mercedes me connect service "Telediagnosics" is active, a similar prompt can appear after a delay in the event of a breakdown. If you are already in contact with the Mercedes-Benz Customer Center or have already received support, this prompt can be ignored or declined.
- ❗ If you answer the prompt for support from the Mercedes-Benz Customer Center with **Call Later**, the message will be hidden and appear again later.
The prompt triggered by the Mercedes me connect service "Telediagnosics", can either be confirmed or declined. After being declined, this will not be shown again.

■ Arranging a service appointment via a Mercedes me call

If you have activated the maintenance management service, relevant vehicle data is transferred automatically to the Mercedes-Benz Customer Center. You will then receive individual recommendations regarding the maintenance of your vehicle.

Regardless of whether you have consented to the maintenance management service, the multimedia system reminds you after a certain amount of time that a service is due. A prompt appears asking if you would like to make an appointment.

▶ **To arrange a service appointment:** select **Call**. After your consent, the vehicle data is transferred and the Mercedes-Benz Customer Center takes your preferred appointment date. The information is then sent to your desired service outlet.

This will contact you to confirm the appointment and if necessary consult about the details.

- ❗ If you select **Call Later** after the service message appears, the message is hidden and reappears at a later time.

■ Data transferred during a Mercedes me call

If you initiate a service call using Mercedes me, data is transferred to enable targeted advice and an efficient service.

The following requirements must be fulfilled for the transfer of the data:

- The vehicle is switched on.
- The required data transfer technology is supported by the mobile phone network provider.
- The quality of the mobile connection is sufficient.

Multi-stage transfer depends on the following factors:

- Reason for the initiation of the call
- The available mobile phone transmission technology
- The activated Mercedes me connect services
- The service selected in the voice control system

- ❗ The scope of the data transmitted depends on the vehicle model and vehicle equipment. For technical reasons, not all data is available at all times.

Data transfer if Mercedes me connect services are not activated

If no Mercedes me connect services are activated, the following data is transferred:

- Vehicle identification number
- Time of the call
- Reason for the initiation of the call
- Confirmation of the data protection prompt
- Country indicator of the vehicle
- Set language for the multimedia system
- Telephone number of the communication platform installed in the vehicle

If a call is made for a service appointment via the service reminder, the following data is also transmitted:

- Current mileage and maintenance data

If a call is made after automatic accident or breakdown detection using the multimedia system, the following data is also transmitted:

- Current mileage and maintenance data

- Current vehicle location

If Accident and Breakdown Management is called via the voice control system, the following data can also be called up from the vehicle by the Mercedes-Benz Customer Center:

- Current vehicle location

Data processing

The data transmitted within the scope of the call is deleted from the processing system after the call is finished, in so far as this data is not being used for other activated Mercedes me connect services.

The incident-specific data is processed and stored in the Mercedes-Benz Customer Center and, if required to process the incident, forwarded to the service partner authorized by the Mercedes-Benz Customer Center. Take note of the data protection information on the Mercedes me Internet page <https://www.mercedes.me> or in the recorded message immediately after calling the Mercedes-Benz Customer Center.

- ⓘ The recorded message is not available in every country.

Mercedes me connect

Information on Mercedes me connect

Mercedes me connect consists of multiple services.

You can use the following services via the multimedia system and the overhead control panel, for example:

- Accident and Breakdown Management (me button or situation-dependent display in the multimedia system)
- Mercedes-Benz Emergency Call System (automatic emergency call and SOS button)

The Mercedes me connect Accident and Breakdown Management and the Mercedes-Benz emergency call center are available to you around the clock.

The me button and the SOS button can be found on the vehicle's overhead control panel (→ page 264).

You can also call the Mercedes-Benz Customer Center using the multimedia system (→ page 264).

Please note that Mercedes me connect is a Mercedes-Benz service. In emergencies, first call the national emergency services using the standard national emergency service telephone numbers. In emergencies, you can also use the Mercedes-Benz emergency call system (→ page 271).

Please note the Mercedes me connect terms of use and the data protection information for Mercedes me connect. You can find these in your Mercedes me user account.

Further information about Mercedes me connect services can be obtained in the Mercedes me Portal: <https://me.secure.mercedes-benz.com>

■ Information on Mercedes me connect Accident and Breakdown Management

- ❶ Accident and Breakdown Management is not available in every country. Contact an authorized Mercedes-Benz Center to find out whether this function is available in your country.

The Accident and Breakdown Management can include the following functions:

- Supplement to the Mercedes-Benz emergency call system (→ page 271)

If necessary, the contact person at the Mercedes-Benz emergency call center forwards the call to Mercedes me connect Accident and Breakdown Management. Forwarding the call is however not possible in all countries.

- Breakdown assistance by a technician on location and/or the towing away of the vehicle to the nearest authorized Mercedes-Benz Center

You may be charged for these services.

- Addition to the emergency guide after automatic accident or breakdown detection (→ page 265)

In the event of a breakdown or accident, further vehicle data is sent which enables optimal support by the Mercedes-Benz Customer Center and the authorized service partner or breakdown assistance.

- Addition to the Mercedes me connect service Telediagnosics

With the Telediagnosics function, specific wear and failure reports are recorded by the service provider, in so far as these can be clearly interpreted and are available through the monitoring of components that are subject to diagnostics.

If your vehicle detects a breakdown or threat of a breakdown, you may be prompted via the multimedia system to contact the Mercedes-Benz Customer Center for further help. This prompt in the multimedia system only appears when the vehicle is stationary.

- ❶ These services are subject to technical restrictions such as the mobile phone coverage, mobile network quality and the ability of the processing systems to interpret the transferred data. In some circumstances, this can result in delays or the failure of the information to appear in the multimedia system.

Please note that the service and breakdown call is a Mercedes-Benz service. In emergencies, be sure to contact the usual national emergency

number first or use the Mercedes-Benz emergency call system (→ page 271).

More information about Mercedes me connect services can be obtained in the Mercedes me Portal: <https://me.secure.mercedes-benz.com>

■ Data transferred during Mercedes me connect call services

The data transferred during a Mercedes me connect call depends on:

- The reason for initiation of the call
- The service that is selected in the voice control system
- The activated Mercedes me connect services

You can find out which data is transferred when using the services in the currently valid Mercedes me connect terms of use and the data protection information for Mercedes me connect. You can find these in your Mercedes me user account.

Overview of the Mercedes me & Apps menu

When you log in with a user account to the Mercedes me Portal, then services and offers from Mercedes-Benz will be available to you.

For more information consult an authorized Mercedes-Benz Center or visit the Mercedes me Portal: <https://me.secure.mercedes-benz.com>

- ① Make sure you always keep the Mercedes me Apps updated.

You can call up the menu using **Apps** in the multimedia system.

In the **Apps** menu, the following options can be available:

- Connecting the vehicle with the **Mercedes me** user account
- Deleting a connection between a user account **Mercedes me** and the vehicle
- Calling up the Mercedes me services
- Calling up apps such as In-Car Office or the web browser depending on availability

Web browser overview

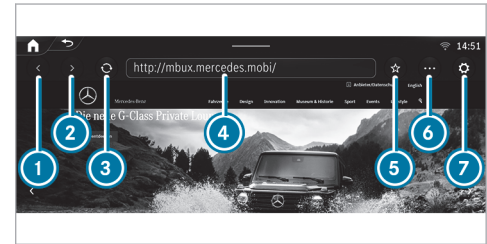

- ① Previous website
 - ② Next website
 - ③ Update
 - ④ URL
 - ⑤ Adds/removes bookmarks
 - ⑥ Options
 - ⑦ Settings
- ① Under **[...]** you have the following options:
- **Tabs**
 - **Bookmarks & History**
 - **Reading Mode**

- [Share Link](#)
- [Share Content](#)
- [Request Mobile Website](#)

❗ Websites cannot be shown while the vehicle is in motion.

Overview of Smartphone Integration

With Smartphone Integration, you can use certain functions on your mobile phone via the multimedia system display.

Only one mobile phone at a time can be connected via Smartphone Integration to the multimedia system. Also for use with two phone mode with Smartphone Integration, only one additional mobile phone can be connected using Bluetooth® with the multimedia system.

The full range of functions for Smartphone Integration is only possible with an internet connection. The appropriate application must be downloaded on the mobile phone to use Smartphone Integration. The mobile phone must be switched on and connected to the multimedia system via the USB port using a suitable cable.

Apps for Smartphone Integration:

- Apple CarPlay® (wireless connection via Bluetooth® also possible)
- Android Auto (wireless connection via Bluetooth® also possible)

❗ For safety reasons, the first activation of Apple CarPlay® or Android Auto on the multimedia system must be carried out when the vehicle is stationary with the parking brake.

You can start Smartphone Integration using the **Devices** menu.

You can end Smartphone Integration via the **Devices** or by disconnecting the connecting cable between the mobile phone and multimedia system.

❗ Mercedes-Benz recommends disconnecting the connection via the device manager or the connecting cable only when the vehicle is stationary.

Overview of transferred vehicle data

When using Smartphone Integration, certain vehicle data is transferred to the mobile phone. This

enables you to get the best out of selected mobile phone services. Vehicle data is not directly accessible.

The following system information is transmitted:

- Software release of the multimedia system
- System ID (anonymized)

The transfer of this data is used to optimize communication between the vehicle and the mobile phone.

To do this, and to assign several vehicles to the mobile phone, a vehicle identifier is randomly generated.

This has no connection to the vehicle identification number (VIN) and is deleted when the multimedia system is reset (→ page 249).

The following driving status data is transmitted:

- Transmission position engaged
- Distinction between parked, standstill, rolling and driving
- Day/night mode of the driver's display
- Drive type

The transfer of this data is used to alter how content is displayed to correspond to the driving situation.

The following position data is transmitted:

- Coordinates
- speed
- Compass direction
- Acceleration direction

The mobile phone uses this data to improve the accuracy of navigation, for example, when driving through a tunnel.

Mercedes-Benz emergency call system

Information on the Mercedes-Benz emergency call system

Your vehicle is equipped with the Mercedes-Benz emergency call system (“eCall”). This feature can help save lives in the event of an accident. eCall in no way replaces assistance provided from dialing 911.

Mercedes-Benz eCall only functions in areas where mobile phone coverage is available from the wireless service providers. Insufficient network coverage from the wireless service providers may result in an emergency call not being transmitted.

eCall is a standard feature in your Mercedes-Benz vehicle. In order to function as intended, the system relies on the transmission of data detailed in the Transmitted Data section that follows.

To disable eCall, a customer must visit an authorized Mercedes-Benz Service department to deactivate the vehicle’s communication module.

Deactivation of this module prevents the activation of any and all Mercedes me connect services. After the deactivation of eCall, automatic emergency call and manual emergency call will not be available.

The vehicle must be switched on before an automatic emergency call can be made.

- ① eCall is activated at the factory.
- ① eCall can be deactivated by an authorized Mercedes-Benz dealer. Please note that in the event ownership of the vehicle is transferred

to another owner in its deactivated state, eCall will remain deactivated unless the new owner visits an authorized Mercedes-Benz dealership to reactivate the system.

Overview of the Mercedes-Benz emergency call system

eCall can help to reduce the time between an accident and the arrival of emergency services at the site of the accident. It helps locate an accident site in places that are difficult to access. However, even if a vehicle is equipped with eCall, this does not mean the system is ON. As such, eCall does not replace dialing 911 in the event of an accident.

An emergency call can be made automatically or manually.

Only make emergency calls if you or others are in need of rescue. Do not make an emergency call in the event of a breakdown or a similar situation.

Information on the display:

SOS NOT READY: the vehicle is not on or eCall not available.

During an active emergency call, <schar> appears in the display.

You can find more information on the regional availability of eCall at: <https://www.mercedes-benz-mobile.com/extra/ecall/>

i If there is a malfunction of the emergency call system, the loudspeakers, microphone, air bag or the SOS button, for example, are faulty.

You can recognize a malfunction in the emergency call system by the following displays:

- A corresponding message appears on the driver display.
- The SOS button lights up red continuously.

Triggering an automatic Mercedes-Benz emergency call

Requirements:

- The vehicle is switched on.
- The starter battery is sufficiently charged.

The Mercedes-Benz emergency call system triggers an emergency call automatically in the following cases:

- After activation of the restraint systems such as air bags or Emergency Tensioning Devices after an accident

The emergency call has been made:

- A voice connection is made to the Mercedes-Benz emergency call center.
- A message with accident data is transmitted to the Mercedes-Benz emergency call center.

The Mercedes-Benz emergency call center can transmit the vehicle position data to one of the emergency call centers.

The SOS button in the overhead control panel flashes until the emergency call is finished.

It is not possible to immediately end an automatic emergency call.

If no connection can be made to the emergency services either, a corresponding message appears in the media display.

▶ Dial the local emergency number on your mobile phone.

If an emergency call has been initiated:

- Remain in the vehicle if the road and traffic conditions permit you to do so until a voice connection is established with the emergency call center operator.
- Based on the call, the operator decides whether it is necessary to call rescue teams and/or the police to the accident site.
- If no vehicle occupant answers, an ambulance is sent to the vehicle immediately.

Triggering a manual Mercedes-Benz emergency call

▶ **To use the SOS button in the overhead control panel:** press the SOS button at least one second long (→ page 264).

or

▶ **To use voice control:** use the voice commands of the MBUX Voice Assistant.

The emergency call has been made:

- A voice connection is made to the Mercedes-Benz emergency call center.
- A message with accident data is transmitted to the Mercedes-Benz emergency call center.

The Mercedes-Benz emergency call center can transmit the vehicle position data to one of the emergency call centers.

- Remain in the vehicle if the road and traffic conditions permit you to do so until a voice connection is established with the emergency call center operator.
- Based on the call, the operator decides whether it is necessary to call rescue teams and/or the police to the accident site.

If no connection can be made to the emergency services, a corresponding message appears in the central display.

- ▶ Dial the local emergency number on your mobile phone.

Ending an unintentionally triggered manual Mercedes-Benz emergency call

- ▶ Select  on the multifunction steering wheel. Depress button for several seconds.

Data transfer of the Mercedes-Benz emergency call system

In the event of an automatic or manual emergency call the following data is transmitted, for example:

- Vehicle's GPS position data
- GPS position data on the route (a few hundred meters before the incident)
- Direction of travel
- Vehicle identification number
- Vehicle drive type
- Number of people detected in the vehicle
- Whether Mercedes me connect is available or not
- Whether the emergency call was initiated manually or automatically
- Time of the accident

- Language setting on the multimedia system

Data transmitted is vehicle information. For any questions about the collection, use and sharing of the eCall system data, please contact MBUSA's Customer Assistance Center at 800-FOR-MERC.

For Canada, please contact MBC's Customer Assistance Center at 1-800-387-0100.









Customer requests for covered information should be submitted via the same channels.





For accident clarification purposes, the following measures can be taken up to an hour after the emergency call has been initiated:

- The current vehicle position can be determined.
- A voice connection to the vehicle occupants can be established.

Radio & media

Overview of the symbols and functions in the media menu







Symbol	Designation	Function
	Play	Select to start or continue playback.
	Rest	Select to pause the playback.
	Repeat a track	Select to repeat the current track or the active playlist. <ul style="list-style-type: none"> • Select once: the active playlist is repeated. • Select twice: the current track is repeated. • Select three times: the function is deactivated.
	Random playback	Select to play back the tracks in random order.
	Skip forwards/back	Select to skip to the next or to the previous track.
	Additional options	Select to show additional options.
	Categories	Select to show or search through available categories such as playback lists, albums or artists.
	Search	Select to search in the active menu. You can search for artists, genres or moods, for example.

Symbol	Designation	Function
	Settings	Select to make settings.
	Home	Select to return to the home screen.
	Messaging	Select to call up messaging.
	Full screen	Select to switch to full screen mode.

The following functions and settings are available in the **Media** menu:





- Connecting external data storage media with the multimedia system (e.g. using USB or Bluetooth®)
- Playing back audio or video files

Overview of the symbols and functions in the radio menu

Symbol	Designation	Function
	Home	Select to return to the home screen.
	Messaging	Select to call up messaging.
	Skip forwards/back	Select to skip to the next or to the previous station.
	Settings	Select to have further options shown. The setting options are country-dependent.
HD	HD radio™	Select to switch the HD Radio™ function on or off. This function is not available in all countries.
	Station list	Select to have the station list shown.
	Search	Select to search in the active menu. You can search for artists, genres or moods, for example.

Additional functions of TuneIn Radio

-  A relatively large volume of data can be transmitted when using TuneIn Radio.

Symbol	Designation	Function
	Settings	The following additional settings are available in the TuneIn Radio menu: <ul style="list-style-type: none"> • Selecting stream • Logging on to or out of the TuneIn account
	Favorites	Select during playback to save the station currently set as a favorite.
	Play/Pause	Select to start, stop or continue playback.
	Browse	Select to choose a category and then a radio station.



Additional functions of the satellite radio

SIRIUS XM[®] satellite radio offers more than 175 digital-quality radio channels providing commercial-free music, sports, news and entertainment, for example. SIRIUS XM[®] satellite radio employs a fleet of high-performance satellites to broadcast

around the clock throughout the USA and Canada. The satellite radio program is available for a monthly fee. Information about this can be obtained from a Sirius XM[®] Service Center and at <https://www.siriusxm.com> (USA).

 Sirius, XM and all related marks and logos are trademarks of Sirius XM Radio Inc. and its subsidiaries. All other marks, channel names

and logos are the property of their respective owners. All rights reserved.

Symbol	Designation	Function
	Settings	The following additional settings are available in the satellite radio menu: <ul style="list-style-type: none"> • Activate child safety lock to lock channels with adult content • Set alarm program for music and sport alerts • Create TuneMix lists to listen to music seamlessly
	Play	Select to start or continue playback.
	Rest	Select to pause the playback.

Depending on the frequency band selected, different functions are available to you.

Select the desired frequency band in the radio menu head runner.

Calling up Tuneln Radio

Requirements:

- There is a user account at <https://www.mercedes.me>.
- The vehicle is linked to the Mercedes me user account.
- The Tuneln Radio service is activated in the Mercedes me portal.

- The data volume is available. Depending on the country, data volume may need to be purchased.
 - A fast Internet connection for data transmission free of interference.
-  New data volume can be purchased **directly from a mobile phone network provider** via the Mercedes me Portal.

-  The functions and services are country-dependent. For more information, consult an authorized Mercedes-Benz Center.

Multimedia system:

  **Radio**

-  Select **TuneIn Radio**.
The TuneIn menu appears. The last station set starts playing.

-  The connection quality depends on the local mobile phone reception.





Setting up satellite radio

Requirements:

- Satellite radio equipment is available.
- Registration with a satellite radio provider has been completed.
- If registration is not included when purchasing the system, your credit card details will be required to activate your account.

Multimedia system:

  **Radio**  **SiriusXM**
 

-  Select **Service Information**.
The service information screen appears showing the radio ID and the current subscription status.
 -  Establish a telephone connection.
 -  Follow the service staff's instructions.
The activation process may take up to ten minutes.
-  You can also have the satellite service activated online. To do so, please visit <https://www.siriusxm.com> (USA) or <https://www.siriusxm.ca> (Canada).

Music and sport alerts

Multimedia system:

  **Radio**  **SiriusXM**
   **Alerts**

Setting music and sport alerts

This function enables you to program an alert for your favorite artists, tracks or sporting events. Music alerts can be saved whilst a track is being played and sport alerts can be saved during a live game. You can also specify sport alerts via the menu option. The system then continuously searches through all the channels.

-  Set a music or sports alert, to be informed of matches in the Live program.

Activating messages for a category

-  Select a category and activate .

Adding messages for a category

-  Select a category and add a message .

- ▶ Select **Artist Alerts** or **Track Alerts** in the dialog window.
The message is set for the activated track and artist. If a match is found, a prompt appears asking whether you wish to change to the station.

Deleting messages in a category

- ▶ Select a category, mark the desired messages and delete .

or

- ▶ Do not mark any messages and delete all entries .

Sound settings

Overview of functions in the sound menu

The setting options and functions available depend on the sound system installed. You can find out which sound system is installed in your vehicle in the Digital Operator's Manual.

Standard sound system

The following functions are available:

- Equalizer
 - Treble, mid-range and bass
- Balance and fader
- Volume
 - Automatic adjustment

ASSYST PLUS service interval display

Function of the ASSYST PLUS service interval display

The ASSYST PLUS service interval display on the driver's display provides information on the remaining time or distance before the next service due date.

You can hide this service display using the back button  on the steering wheel.

Depending on how the vehicle is used, the ASSYST PLUS service interval display may shorten the service interval, e.g. in the following cases:

- Mainly short-distance driving
- When the engine is often left idling for long periods
- In the event of frequent cold start phases

Mercedes-Benz recommends avoiding such operating conditions.

You can obtain information concerning the servicing of your vehicle from a qualified specialist workshop, e.g. an authorized Mercedes-Benz Center.

Displaying the service due date

Driver display:



The next service due date is displayed.

▶ **To exit the display:** press the back button  on the steering wheel.

Bear in mind the following related topic:

- Operating the driver display (→ page 228).

Information on regular maintenance work

! **NOTE** Premature wear through failure to observe service due dates

Maintenance work which is not carried out at the right time or incompletely can lead to increased wear and damage to the vehicle.

- ▶ Adhere to the prescribed service intervals.
- ▶ Always have the prescribed maintenance work carried out at a qualified specialist workshop.

Notes on special service requirements

The prescribed service interval is based on normal operation of the vehicle. Have the maintenance work carried out more often than prescribed if operating conditions are difficult or the vehicle is subject to increased stress.

The ASSYST PLUS service interval display is only an aid. It is the responsibility of the driver of the vehicle to have maintenance work carried out more often than prescribed due to actual operating conditions and/or stresses.

Examples of arduous operating conditions:

- Regular city driving with frequent intermediate stops
- Mainly short-distance driving
- Frequent operation in mountainous terrain or on poor road surfaces
- When the engine is often left idling for long periods
- Operation in particularly dusty conditions and/or if air-recirculation mode is frequently used

In these or similar operating conditions, have the interior air filter, air filter, engine oil and oil filter, for example, changed more frequently. If subject to increased stress, check the tires more. Further information can be obtained at a qualified specialist workshop.

Battery disconnection periods

The ASSYST PLUS service interval display can calculate the service due date only when the battery is connected.

- ▶ Display and note down the service due date on the driver display before disconnecting the battery (→ page 281).

Maintenance Management

Notes about Maintenance Management

If the Maintenance Management service is activated, relevant data is automatically transferred to the Mercedes-Benz customer center.

The customer center transmits the data to the service partner that you have entered on the

Mercedes me website at: <http://www.mercedes.me>. You will then receive individual recommendations regarding the maintenance of your vehicle.

- ① The calculation of the optimal transmission time of the maintenance request to the service partner is subject to technical limitations that may cause the maintenance recommendation to be perceived as too early or too late or not to be made at all. In this case, you can conveniently arrange a maintenance appointment with the customer center via the maintenance reminder in the multimedia system.
- ① Maintenance Management and the maintenance reminder in the multimedia system are not available in every country. Contact an authorized Mercedes-Benz Center to find out whether this function is available in your country.

Data transferred when using Maintenance Management

When the service is activated, relevant data is automatically transferred to determine the required scope of maintenance as well as malfunction detection and malfunction rectification.

Details on data transfer can be found in the data protection information for the Mercedes me connect services. These can be found at: <https://www.mercedes.me> under "My Account", "Data Protection & Legal Notice".

- ① Maintenance Management and the maintenance reminder in the multimedia system are not available in every country.

Telediagnosis

Notes about Telediagnosis

- ① This service is not available in all countries. The vehicle can detect if certain wear parts need to be replaced or if malfunctions have occurred in vehicle systems. If the Telediagnosis service is activated, relevant data is automatically transmit-

ted to the manufacturer. If fault conditions are detected by the vehicle system self-diagnosis, the system transmits recommendations for action to the Mercedes-Benz customer center depending on the fault detected. The customer center transmits the data to the service partner that you have entered on the Mercedes me website at: <http://www.mercedes.me>.

For selected faults, the notification that a malfunction has been detected may appear in the multimedia system with a request to contact the Mercedes-Benz customer center. From this message, a call can be made directly to the customer center for assistance.

- ❗ The transmission of a notification to the multimedia system depends on the country, vehicle model and equipment and requires a fast data connection, over which the service provider has no influence.
- ❗ Reliable fault detection is subject to technical limitations. Therefore, only a limited selection of faults can be detected and recommendations for action transmitted to the customer center and the service partners. Mercedes-Benz AG is continuously working on the

expansion of this service. The fault detection depends on the country, vehicle model and equipment.

Data transferred when using Telediagnosics

When the service is activated, relevant data is automatically transferred to determine the required scope of maintenance as well as malfunction detection and malfunction rectification.

Details on data transfer can be found in the data protection information for the Mercedes me connect services. These can be found at: <https://www.mercedes.me> under "My Account", "Data Protection & Legal Notice".

- ❗ The scope of the transmitted data depends on the vehicle model and its equipment. For technical reasons, not all data is available at all times.

Engine compartment

Opening and closing the hood

⚠ WARNING Risk of accident due to driving with the hood unlocked

The hood may open and block your view.

- ▶ Never release the hood when driving.
- ▶ Before every trip, ensure that the hood is locked.

⚠ WARNING Risk of accident and injury when opening and closing the hood

The hood may suddenly drop into the end position.

There is a risk of injury for anyone in the hood's range of movement.

- ▶ Do not open or close the hood if there is a person in the hood's range of movement.

⚠ WARNING Risk of burns when opening the hood

If you open the hood in the event of an overheated engine or fire in the engine compartment, the following situations may occur:

- You may come into contact with hot gases.
- You may come into contact with other escaping hot operating fluids.
- ▶ Before opening the hood, allow the engine to cool down.
- ▶ In the event of a fire in the engine compartment, keep the hood closed and call the fire service.

⚠ WARNING Risk of injury due to moving parts

Components in the engine compartment may continue to run or start unexpectedly even when the drive system is switched off.

Observe the following if you must open the hood:

- ▶ Switch off the vehicle.
- ▶ Never touch the danger zones surrounding moving components, e.g. the rotation area of the fan.
- ▶ Remove jewellery and watches.
- ▶ Keep items of clothing and hair away from moving parts.

⚠ WARNING Risk of injury from touching live components

The ignition system and the fuel injection system operate with a high voltage. You could receive an electric shock.

- ▶ Never touch components of the ignition system or fuel injection system when the vehicle is switched on.

The live components include the following, for example:

- Ignition coils
- Fuel injectors

- Electric lines to the ignition coils and the fuel injectors

⚠ WARNING Risk of burns from hot component parts in the engine compartment

Certain component parts in the engine compartment can be very hot, e.g. the engine, the cooler and parts of the exhaust system.

- ▶ Allow the engine to cool down and only touch component parts described in the following.

⚠ WARNING Risk of injury from using the windshield wipers when the hood is open

If the windshield wipers start moving when the hood is open, you could be trapped by the wiper linkage.

- ▶ Always switch off the windshield wipers and the vehicle first if you need to open the hood.

Opening the hood

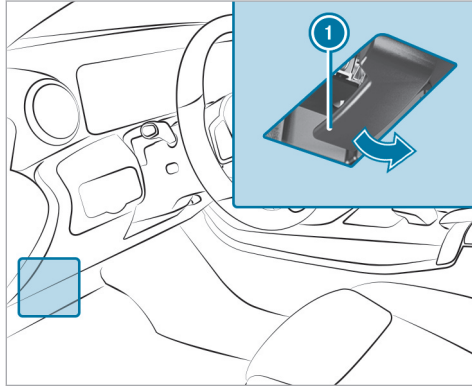

- ▶ To release the hood, pull on handle ①.

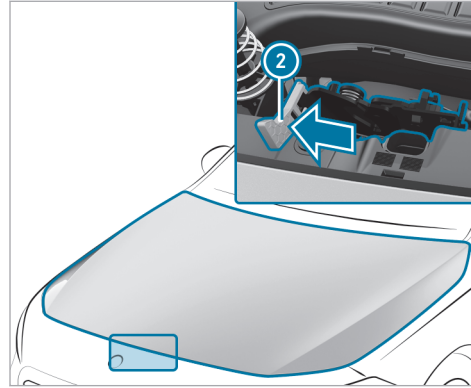

- ▶ Push yellow handle ② on the hood catch to the left as far as it will go (palm downwards). Lift the hood until it is automatically raised by the pneumatic spring.

Closing the hood

- ▶ Lower the bonnet and let it drop from a height of approximately 8 in (20 cm).

- ▶ If the hood can still be lifted slightly, open the hood again and close it with a little force until it engages correctly.

Engine oil

Checking the engine oil level using the driver's display

Requirements

- The engine has been warmed up.
- The vehicle is parked on a level surface.
- The engine is running at idle speed.
- The hood is closed.

Determining the engine oil level can take up to 30 minutes with a normal driving style and even longer with an active driving style.

Driver display:

↪ [Service](#)

The engine oil level is shown.

One of the following messages will appear on the driver's display:

- **Engine Oil Level Measuring Now...**: the engine oil level cannot be determined yet.
- ▶ Repeat the request after a maximum of 30 minutes' driving.
- **Engine Oil Level OK** and the bar display for indicating the engine oil level on the driver's display is green and is between "min" and "max": the engine oil level is correct.
- **Engine Oil Level Refill 1,0 liq.gal.** and the bar display for indicating the engine oil level on the driver's display is yellow and is below "min":
- ▶ Add 1.1 US qt (1 l) of engine oil.
- **Engine Oil Level Reduce** and the bar display for indicating the engine oil level on the driver's display is yellow and is above "max":
- ▶ Drain off any excess engine oil that has been added. To do so, consult a qualified specialist workshop.
- **For Engine Oil Level Switch on Vehicle**

- ▶ Switch on the vehicle to check the engine oil level.
- **Engine Oil Level System Inoperative:** The oil level sensor is defective or not connected.
- ▶ Consult a qualified specialist workshop.
- **Engine Oil Level System Currently Unavailable**
- ▶ Close the hood.

■ Adding engine oil

⚠ WARNING Risk of burns from hot component parts in the engine compartment

Certain component parts in the engine compartment can be very hot, e.g. the engine, the cooler and parts of the exhaust system.

- ▶ Allow the engine to cool down and only touch component parts described in the following.

⚠ WARNING Risk of fire and injury from engine oil

If engine oil comes into contact with hot component parts in the engine compartment, it may ignite.

- ▶ Make sure that no engine oil is spilled next to the filler opening.
- ▶ Allow the engine to cool off and thoroughly clean the engine oil from component parts before starting the vehicle.

! NOTE Engine damage caused by an incorrect oil filter, incorrect oil or additives

- ▶ Do not use engine oils or oil filters which do not correspond to the specifications explicitly prescribed for the service intervals.
- ▶ Follow the instructions on the service interval display for changing the engine oil and observe the prescribed change intervals.
- ▶ Do not use additives.

! **NOTE** Damage caused by adding too much engine oil

Excessive engine oil can damage the engine or the catalytic converter.

- ▶ Have excess engine oil removed in a qualified specialist workshop.

i Depending on driving style, the vehicle consumes up to 0.9 US qt (0.8 liters) of oil per 600 miles (1,000 km). The oil consumption may also be higher than this when the vehicle is new or if you frequently drive at high engine speeds.

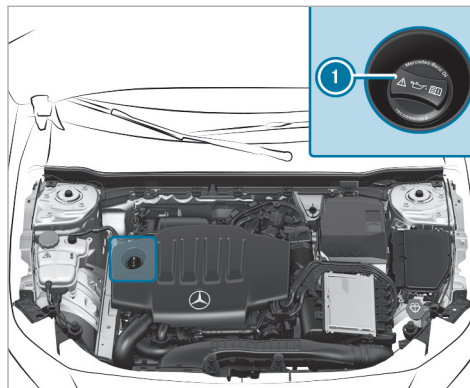

- ▶ Turn cap **1** counter-clockwise and remove it.
- ▶ Add engine oil.
- ▶ Replace cap **1** and turn it clockwise until it engages.
- ▶ Check the oil level again (→ page 285).

Checking the coolant level

! **WARNING** Risk of scalding from hot coolant

If you open the cap, you could scald yourself.

- ▶ Allow the engine to cool down before opening the cap.
- ▶ When opening the cap, wear protective gloves and safety glasses.
- ▶ Open the cap slowly to release pressure.

! **WARNING** Risk of burns from hot component parts in the engine compartment

Certain component parts in the engine compartment can be very hot, e.g. the engine, the cooler and parts of the exhaust system.

- ▶ Allow the engine to cool down and only touch component parts described in the following.

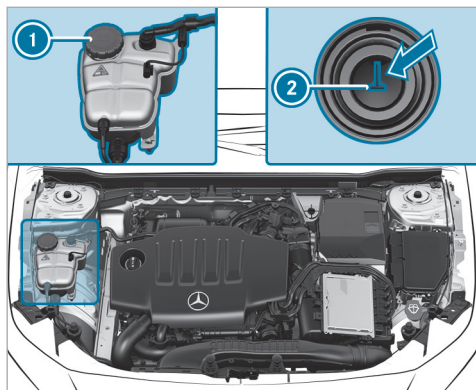

- ▶ Park the vehicle on a level surface.
- ▶ Check the coolant temperature reading in the driver display.
The coolant temperature must be in the bottom quarter of the temperature display.
- ▶ Slowly turn the cap ① counter-clockwise to release overpressure.

- ▶ Continue turning the cap ① counter-clockwise and remove it.

The coolant level is correct in the following cases:

- if the engine is cold, the coolant is up to marker bar ②.
- if the engine is warm, the coolant is up to 0.6 in (1.5 cm) over the marker bar ②.
- ▶ If necessary, add coolant that has been approved for Mercedes-Benz.
- ① Further information on coolant (→ page 360).

Refilling the windshield washer system

⚠ WARNING Risk of burns from hot component parts in the engine compartment

Certain component parts in the engine compartment can be very hot, e.g. the engine, the cooler and parts of the exhaust system.

- ▶ Allow the engine to cool down and only touch component parts described in the following.

⚠ WARNING - Risk of fire and injury from windshield washer concentrate

Windshield washer concentrate is highly flammable. It could ignite if it comes into contact with hot engine component parts or the exhaust system.

- ▶ Make sure that no windshield washer concentrate spills out next to the filler opening.

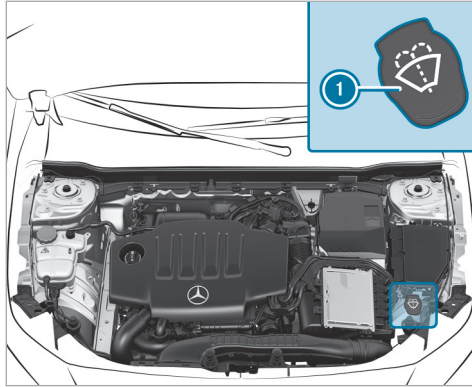

- ▶ Remove cap ① by the tab.
- ▶ Add washer fluid.

① Further information about the windshield washer fluid (→ page 361).

Keeping the air/water duct free

- ▶ Keep the area between the hood and the windshield free of deposits, e.g. ice, snow or leaves.

Checking the brake lining thickness

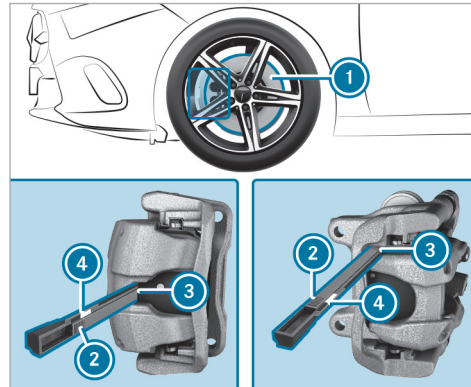

- ▶ Bring the vehicle and wheels into a suitable position so that you can position the gage.

① Measuring point ③ for the test gage depends on the equipment. The gage is positioned at point ③, which is located either in the center of the brake lining or at the upper end to the side, depending on the brake caliper.

- ▶ Switch off the vehicle.
- ▶ Secure the vehicle against rolling away.
- ▶ Take the gage out of the vehicle document wallet in the glove compartment.
- ▶ Place the test gage between the wheel spokes at measuring point ③ on the brake lining.
- ▶ Hold the gage vertically to brake disc ① and slide measuring pin ② onto brake disc ①.
- ▶ Check which color field ④ the arrow on measuring pin ② is pointing to.

Green: the brake lining thickness is sufficient.

Red: the brake lining thickness is not sufficient. Have the brake linings checked at a qualified specialist workshop.

- ⓘ To avoid an inaccurate measurement:
- Make sure the wheels are suitably positioned.
 - In the case of perforated brake discs, do not put the measuring pin on one of the bores in the brake disc.

Cleaning and care

Information on washing the vehicle in a car wash

⚠ WARNING Risk of accident due to reduced braking effect after washing the vehicle

The braking effect is reduced after washing the vehicle.

- ▶ After the vehicle has been washed, brake carefully while paying attention to the traffic conditions until the braking effect has been fully restored.

! NOTE Damage from automatic braking

If one of the following functions is activated, the vehicle will brake automatically in certain situations:

- Active Brake Assist
- Active Distance Assist DISTRONIC
- HOLD function
- Active Parking Assist

To avoid damage to the vehicle, switch off these systems, e.g. when towing or using a car wash.

! NOTE Damage due to unsuitable car wash

- ▶ Before driving into a car wash make sure that the car wash is suitable for the vehicle dimensions.
- ▶ Ensure there is sufficient ground clearance between the underbody and the guide rails of the car wash.

- ▶ Ensure that the clearance width of the car wash, in particular the width of the guide rails, is sufficient.

To avoid damage to your vehicle when using a car wash, ensure the following beforehand:

- Active Distance Assist DISTRONIC is deactivated.
- the HOLD function is switched off.
- the 360° Camera or the reversing camera is switched off.
- the side windows and sliding sunroof are completely closed.
- the blower for the ventilation and heating is switched off.
- the windshield wiper switch is in position **0**.
- the key is at a minimum distance of 10 ft (3 m) away from the vehicle. Otherwise the trunk lid could open unintentionally.
- for car washes with a conveyor system:
 - Neutral **N** is engaged.

- If you would like to leave the vehicle while it is being washed, make sure the key is located in the vehicle. The park position **P** is otherwise automatically engaged.

i If, after the car wash, you remove the wax from the windshield and wiper rubbers, this will prevent smearing and reduce wiper noise.

Car wash mode

In car wash mode, the vehicle is configured in readiness for entering an automatic car wash. Car wash mode can be activated up to a speed of 12 mph (20 km/h) (→ page 291).

The following settings will be adjusted when car wash mode is activated:

- The outside mirrors will be folded in.
- To prevent the windshield washer system from starting up automatically, the rain sensor will be deactivated.
- Parking Assist PARKTRONIC will be deactivated.
- **Vehicles with 360° camera:** the front image will be activated after approximately eight seconds.

If one of the settings cannot be selected, this will be indicated by a **X** after the respective setting.

Car wash mode will automatically be deactivated above a speed of 12 mph (20 km/h).

The following settings will be reset when car wash mode is deactivated:

- The outside mirrors will be folded out.
- The rain sensor will be activated.
- Parking Assist PARKTRONIC will be reset to the previously selected setting.
- **Vehicles with 360° camera:** the front image will be deactivated at speeds above 11 mph (18 km/h).

Switching car wash mode on/off

Requirements:

- The vehicle is stationary.

- The vehicle is switched on.

Multimedia system:

→  **▶▶ Settings ▶▶ Vehicle ▶▶ Driving**

Activating car wash mode

- ▶ Select **Automatic Car Wash Mode**.
- ▶ Select **Activate**.

If one of the settings cannot be selected, this will be shown by a **X** next to the respective setting.

i For an overview of the settings configured when you activate car wash mode (→ page 291).

Deactivating car wash mode

- ▶ Select **Switch Off**.
The settings of car wash mode will be reset.
- i** Car wash mode will be automatically deactivated as soon as your speed exceeds 12 mph (20 km/h).

Information on using a power washer

⚠ WARNING Risk of an accident when using power washers with round-spray nozzles

The water jet can cause externally invisible damage.

Components damaged in this way may unexpectedly fail.

- ▶ Do not use a power washer with round-spray nozzles.
- ▶ Have damaged tires or chassis parts replaced immediately.

To avoid damage to your vehicle, observe the following when using a power washer:

- The key is at a minimum distance of 10 ft (3 m) away from the vehicle. Otherwise the trunk lid could open unintentionally.
- Maintain a distance of at least 11.8 in (30 cm) to the vehicle.
- **Vehicles with decorative films:** Parts of your vehicle are covered with a decorative film. Maintain a distance of at least 27.6 in (70 cm)

between the film-covered parts of the vehicle and the nozzle of the power washer. Move the nozzle of the power washer around while cleaning. The water temperature of the power washer must not exceed 140°F (60°C).

- Observe the information on the correct distance in the equipment manufacturer's operating instructions.
- Do not point the nozzle of the power washer directly at sensitive parts, e.g. tires, gaps, electrical components, batteries, illuminants or ventilation louvers.

Washing the vehicle by hand

! NOTE Engine damage due to water ingress

- ▶ Take care not to point the water jet directly towards the air inlet grille below the hood.

Observe the relevant legal requirements (e.g. in some countries, washing by hand is permitted only in specially designated wash bays).

- ▶ Use a mild cleaning agent, e.g. car shampoo.
- ▶ Do not use acidic cleaning agents.
- ▶ Wash the vehicle with lukewarm water using a soft car sponge. When doing so, do not expose the vehicle to direct sunlight.
- ▶ Carefully hose the vehicle off with water and dry using a chamois.
- ⓘ Observe the notes on the care of vehicle parts (→ page 294).

Notes on paintwork/matte finish paintwork care

To avoid damaging the paintwork and interfering with the driving assistance systems, please observe the following notes:

Paint

- Insect remains: soak with insect remover and rinse off the treated areas afterwards.
- Bird droppings: soak with water and rinse off afterwards.
- Tree resin, oils, fuels and greases: remove by rubbing gently with a cloth soaked in petroleum ether or lighter fluid.

- Coolant and brake fluid: remove with a damp cloth and clean water.
- Tar stains: use tar remover.
- Wax: use silicone remover.
- Do not attach stickers, films or similar materials. Only have film attached to the bumper at a qualified specialist workshop.
- Remove dirt immediately, where possible. Do not use acidic solutions and acidic cleaning agents.

Matte finish

- Only use care products approved for Mercedes-Benz.
- Do not attach stickers, films or similar materials. Only have film attached to the bumper at a qualified specialist workshop.
- Do not polish the vehicle or the light-alloy wheels.
- Only use car washes that correspond to the latest engineering standards.
- Do not use a car wash program with a final hot wax treatment.

- Do not use paint cleaners, buffing or polishing products, gloss preservers, e.g. wax.

In the event of paintwork damage:

- Always have paintwork repairs carried out at a qualified specialist workshop.
- Make sure the radar sensors function (→ page 173).

Notes on cleaning decorative car films

Please observe the "Notes on paintwork/matt paintwork care" (→ page 292). These notes also apply for matt decorative car films.

To avoid damage, please observe the notes on cleaning decorative car films.

Cleaning

- When cleaning with a power washer, maintain a minimum distance of 27.6 in (70 cm) between the film-covered parts of the vehicle and the nozzle of the power washer.
- To clean, use lots of water and a mild cleaning agent without additional or abrasive products,

e.g. a car shampoo approved for Mercedes-Benz.

- Do not use any acidic cleaning agents.
- Remove dirt immediately, if possible. Avoid hard rubbing to avoid damaging the decorative car film irreparably.
- In case of dirt embedded in the surface or a dull decorative car film: use the 'Paint Cleaner' cleaning agent recommended and approved for Mercedes-Benz.
- Insect remains: Soak with insect remover and rinse off the treated areas afterwards.
- Bird droppings: Soak with water and rinse off afterwards.
- Dry vehicles covered with car film after every wash using a soft, absorbent cloth to prevent water stains.

Preventing damage to the decorative car film

- The durability and color of decorative car films are affected by:
 - Solar radiation
 - Temperature, e.g. heat gun

- Weather
- Stone chips and dirt
- Chemical cleaning products
- Products containing grease
- Do not use polishes on matt decorative car films. Polishing results in the film-covered surface developing a shine.
- Do not use wax on matt or structured decorative car films. This may result in permanent stains.

Scratches, corrosive deposits, etched areas and damage caused by inadequate care cannot always be completely repaired. In such cases, please contact a qualified specialist workshop.

For more information about special care and cleaning products, please contact the manufacturer.

Laminated surfaces may exhibit optical differences to surfaces which were not protected by a decorative film when the decorative film is removed.

- ① Have work or repairs on decorative car film carried out at a qualified specialist workshop, e.g. a Mercedes-Benz Service Center.

Information on window films

! **NOTE** Damage to electronic components due to excess fluids

When window films have been retrofitted, fluids such as cleaning agents or water may run down and get behind trim parts of the vehicle interior and cause damage to electronic components.

- ▶ Use cleaning agents as sparingly as possible.
- ▶ Immediately absorb any excess fluids.

Notes on car parts cleaning and care

! **WARNING** Risk of entrapment if the windshield wipers are switched on while the windshield is being cleaned

If the windshield wipers are set in motion while you are cleaning the windshield or wiper blades, you can be trapped by the wiper arm.

- ▶ Always switch off the windshield wipers and the vehicle before cleaning the windshield or wiper blades.

! **NOTE** Damage caused by acidic cleaning agents

- ▶ Do not use acidic cleaning agents. Otherwise, the surfaces could be damaged.

To avoid damage to the vehicle, observe the notes on cleaning and care of the following car parts:

Windows

! **NOTE** Damage to electronic components due to excess fluids

When cleaning the windows from the inside, fluids such as cleaning agents or water may run down and get behind trim parts of the vehicle interior and cause damage to electronic components.

- ▶ Use cleaning agents as sparingly as possible.
- ▶ Immediately absorb any excess fluids.

- Clean the windows inside and outside with a damp cloth and with a cleaning agent recommended for Mercedes-Benz.
 - Do not use dry cloths or abrasive or solvent-based cleaning agents to clean the insides of windows.
- i** After changing the wiper blades or treating the vehicle with wax, clean the windshield thoroughly with cleaning agents recommended for Mercedes-Benz. Failure to observe the

application instructions may result in damage, smear marks or glare spots.

- i** Remove external misting or dirt on the windshield in front of the multifunction camera. Otherwise, driving systems and driving safety systems may be impaired or unavailable (→ page 173).

Wheels and rims

- Use water and acid-free alloy wheel cleaners.
- Do not use acidic alloy wheel cleaners to remove brake dust. This could damage wheel bolts and brake components.
- To avoid corrosion of the brake discs and pads, drive the vehicle for a few minutes after cleaning before parking it. The brake discs and brake linings will warm up and dry out.

Wiper blades

- Move the wiper arms into the replacement position (→ page 132).
- With the wiper arms folded out, clean the wiper blades with a damp cloth.

- i** Note that the wiper blades are coated. The coating may leave residue on a cloth. Do not rub the wiper blades excessively or clean them too often.

Exterior lighting

- Clean the lenses with a wet sponge and mild cleaning agent (e.g. car shampoo).
- Use only cleaning agents or cleaning cloths that are suitable for plastic lenses.

Sensors

- Clean the sensors in the front and rear part of the vehicle with car shampoo, plenty of water and a soft cloth (→ page 173).
- When using a power washer, maintain a minimum distance of 11.8 in (30 cm).

Cameras

- Open the camera cover with the multimedia system (→ page 214).
- Use clean water and a soft cloth to clean the camera lenses.
- Do not use a power washer.

- ① Remove external misting or dirt on the windshield in front of the multifunction camera. Otherwise, driving systems and driving safety systems may be impaired or unavailable (→ page 173).

Notes on care of the interior

⚠ WARNING Risk of injury from plastic parts breaking off after the use of solvent-based care products

Care and cleaning products containing solvents can cause surfaces in the cockpit to become porous. When the airbags are deployed, plastic parts may break away.

- ▶ Do not use any care or cleaning products containing solvents to clean the cockpit.

⚠ WARNING Risk of injury or fatal injuries from bleached seat belts

Bleaching or dyeing seat belts can severely weaken them.

This can, for example, cause seat belts to tear or fail in an accident.

- ▶ Never bleach or dye seat belts.

! **NOTE** Property damage due to disinfectants

The interior includes a number of sensitive surfaces such as displays, plastics and leather.

Disinfectants can contain alcohol and other substances that penetrate and damage surfaces. Technology behind buttons and displays can also be damaged.

- ▶ Do not use disinfectant on interior surfaces.

To avoid damage to the vehicle, observe the following notes on cleaning and care:

Seat belts

- Clean with lukewarm and soapy water.
- Do not use chemical cleaning agents.

- Do not dry by heating them to over 176°F (80°C) or exposing them to direct sunlight.

Display

- Switch off the display and let it cool down.
- Clean the surface carefully with a microfiber cloth and a suitable display care product (TFT-LCD).
- Do not use any other agents.

Head-up display

- Clean with a soft, non-static, lint-free cloth.
- Do not use cleaning agents.

Plastic trim

- Clean with a damp microfiber cloth.
- For heavy soiling: Use a cleaning agent recommended for Mercedes-Benz.
- Do not attach stickers, films or similar materials.
- Do not allow cosmetics, insect repellent or sun cream to come in contact with the plastic trim.

Real wood and trim elements

- Clean with a microfiber cloth.
- Black piano-lacquer look: clean with a damp cloth and soapy water.
- For heavy soiling: Use a cleaning agent recommended for Mercedes-Benz.
- Do not use solvent-based cleaning agents, polishes or waxes.

Headliner

- Clean with a brush or dry shampoo.

Carpet

- Use a carpet and textile cleaning agent recommended for Mercedes-Benz.

Imitation leather steering wheel

- Clean the entire steering wheel with a damp cotton cloth and a 1% soap solution. Do not spot clean.
- Use cleaning and care products recommended for Mercedes-Benz.
- Do not use a microfiber cloth.
- Do not use oil-based cleaning and care products.

Steering wheel made of genuine leather or DINAMICA**! NOTE** Damage caused by wrong cleaners

▶ Do not use solvent-based cleaning agents such as tar remover or wheel cleaner; neither should you use polishes or waxes. Otherwise you may damage the finish.

- Clean with a damp cloth and a 1% soap solution and then wipe with a dry cloth.
 - For heavy soiling: Use a cleaning agent recommended for Mercedes-Benz.
 - Leather care: Use a leather care agent that has been recommended for Mercedes-Benz.
 - Do not allow the leather to become too damp.
 - Do not use a microfiber cloth.
- ⓘ Leather is a natural product. It has natural surface characteristics, such as differences in structure, marks caused by growth and injury or subtle color differences. These surface characteristics are particular to leather, and

are not material defects. Leather is also subject to a natural aging process, which changes the surface characteristics.

Genuine leather seat covers

- Vacuum up dirt such as crumbs or dust and then clean the seat covers with a damp cotton cloth and wipe down with a dry cloth. Regularly clean the seat covers.
- For heavy soiling: use a leather care agent recommended for Mercedes-Benz aftercare.
- Leather care: Use a leather care agent that has been recommended for Mercedes-Benz.
- Do not use a microfiber cloth.
- Do not allow the leather to become too damp.
- Do not use oil-based cleaning and care products.

- i** Leather is a natural product. It has natural surface characteristics, such as differences in structure, marks caused by growth and injury or subtle color differences. These surface characteristics are particular to leather, and are not material defects. Leather is also subject to a natural aging process, which changes the surface characteristics. Waves or wrinkling in the seat cover may occur due to the stress on the seat; this is caused by the natural leather material. Regular cleaning and care of the leather reduces soiling, wear marks and aging damage and thus significantly extends its life span. Clothing that can leave stains (e.g. jeans) may discolour the leather.

DINAMICA seat covers

- Vacuum up dirt such as crumbs or dust and then use a damp cloth to clean.
- Do not use a microfiber cloth.

Imitation leather seat covers

- Vacuum up dirt such as crumbs or dust and then use a damp cotton cloth and a 1% soap

solution to clean the entire seat cover. Do not spot clean.

- Use cleaning and care products recommended for Mercedes-Benz.
- Do not use a microfiber cloth.
- Do not use oil-based cleaning and care products.

Cloth seat covers

- Vacuum up dirt such as crumbs or dust and then use a damp microfiber cloth and a 1% soap solution to clean the entire seat cover. Do not spot clean.
- Use cleaning and care products recommended for Mercedes-Benz.
- Do not use oil-based cleaning and care products.

Emergency

Removing the safety vest

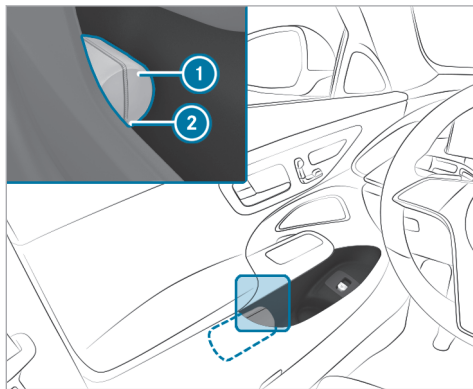

There is a safety vest storage recess in the door storage compartments of all doors for storing the safety vests.

- ▶ To remove: pull out the safety vest bag ① using the loop ②.

- ▶ Open the safety vest bag ① and take out the safety vest.
- ▶ To replace: fold the safety vest, roll it up and insert it into the safety vest bag ①.
- ▶ Slide the safety vest bag ① along the underside of the armrest into the safety vest storage recess. Ensure that the loop ② remains hanging out so that it is easy to grasp.

- ⓘ Remove the packaging film from a new safety vest before sliding it into the safety vest storage recess. Otherwise, it may slide out unintentionally or the packaging may hinder its removal.
- Observe the legal requirements for the individual countries.

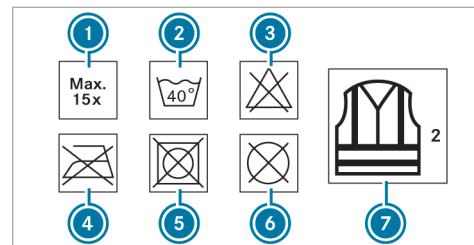

- ① Maximum number of washes
- ② Maximum wash temperature
- ③ Do not bleach
- ④ Do not iron
- ⑤ Do not tumble dry
- ⑥ Do not dry clean
- ⑦ Class 2 safety vest

The requirements defined by the legal standard are only fulfilled if the safety vest is the correct size and is fully closed.

Exchange the safety vest in the following cases:

- The reflective strips are damaged or dirty.

- The maximum permissible number of washes is exceeded.
- The fluorescence has faded, e.g. due to continuous exposure to sunlight.

Dispose of the safety vest in an environmentally friendly way:

- Please contact your local waste disposal company.

Warning triangle

Removing the warning triangle

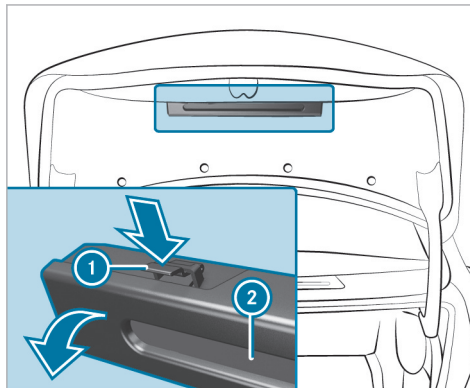

- ▶ Push both sides of the warning triangle holder ① in the direction of the arrow and open it.
- ▶ Remove the warning triangle ②.

Setting up the warning triangle

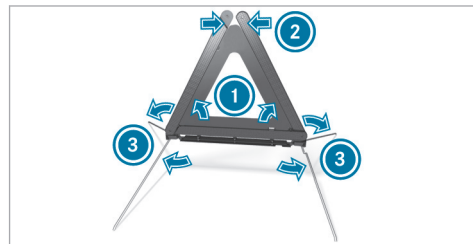

- ▶ Fold the side reflectors ① upwards to form a triangle and attach using the upper snap fastener ②.
- ▶ Fold the legs ③ down and out to the side.

First-aid kit (soft sided) overview

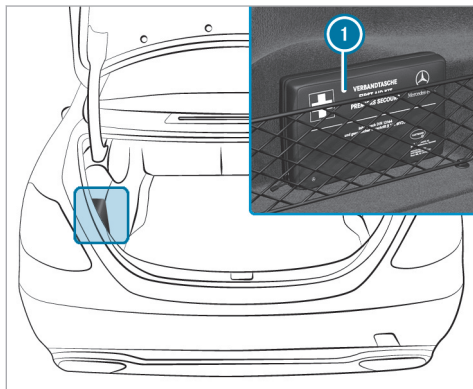

The first-aid kit (soft sided) ① is located in the trunk on the left in the stowage net or under the trunk floor, depending on the respective vehicle version.

Flat tire

Notes on flat tires

⚠ WARNING Risk of accident due to a flat tire

A flat tire severely affects the driving characteristics as well as steering and braking.

Tires without run-flat characteristics:

- ▶ Do not drive on with a flat tire.
- ▶ Change the flat tire immediately with an emergency spare wheel or spare wheel. Alternatively, consult a qualified specialist workshop.

Tires with run-flat characteristics:

- ▶ Observe the information and warning notes on MOExtended tires (run-flat tires).

In the event of a flat tire, you have the following options depending on your vehicle's equipment:

- **Vehicles with MOExtended tires:** it is possible to continue your journey for a short period of

time. Make sure you observe the notes on MOExtended tires (run-flat tires) (→ page 302).

- **Vehicles with a TIREFIT kit:** you can seal the tire so that it is possible to continue your journey for a short period of time. To do this, use the TIREFIT kit (→ page 303).
- **Vehicles with Mercedes me connect:** you can make a call for breakdown assistance via the overhead control panel in the case of a breakdown (→ page 264).
- **All vehicles:** change the wheel (→ page 344).

- ① The emergency spare wheel is available only in certain countries (→ page 349). Vehicles equipped with MOExtended tires are not equipped with a TIREFIT kit at the factory. It is therefore recommended that you additionally equip your vehicle with a TIREFIT kit if you mount tires on your vehicle that do not feature run-flat characteristics, e.g. winter tires. A TIREFIT kit may be obtained from a qualified specialist workshop.

Vehicles with a Mercedes-Benz emergency call system that are not equipped with a TIREFIT kit: in the event of a flat tire, contact the Customer Assistance Center for the Mercedes-Benz emergency call system .

Notes on MOExtended tires (run-flat tires)

⚠ WARNING Risk of accident when driving in limp-home mode

When driving in emergency mode the handling characteristics are impaired.

- ▶ Do not exceed the specified maximum speed of the MOExtended tires.
- ▶ Avoid any abrupt steering and driving maneuvers as well as driving over obstacles (curbs, pot holes, off-road). This applies, in particular, to a loaded vehicle.
- ▶ Stop driving in the emergency mode if you notice:
 - Banging noise
 - Vehicle vibration

- Smoke which smells like rubber
- Continuous ESP® intervention
- Cracks in the tire side walls

- ▶ After driving in emergency mode, have the rims checked by a qualified specialist workshop with regard to their further use.
- ▶ The defective tire must be replaced in every case.

With MOExtended tires (run-flat tires), you can continue to drive your vehicle even if there is a total loss of pressure in one or more tires. However, the tire affected must not show any clearly visible damage.

You can recognize MOExtended tires by the MOExtended marking which appears on the side wall of the tire.

Vehicles with tire pressure monitoring system: MOExtended tires may only be used in conjunction with an activated tire pressure monitoring system.

If a pressure loss warning message appears in the driver's display, proceed as follows:

- Check the tire for damage.
- If driving on, observe the following notes.

Driving distance possible in emergency mode after the pressure loss warning:

Load condition	Driving distance possible in emergency mode
Partially laden	50 miles (80 km)
Fully laden	19 miles (30 km)

The driving distance possible in emergency mode may vary depending on the driving style. Observe the maximum permissible speed of 50 mph (80 km/h).

If a tire has gone flat and cannot be replaced with an MOExtended tire, you can use a standard tire as a temporary measure.

TIREFIT kit storage location

The TIREFIT kit is located under the trunk floor.

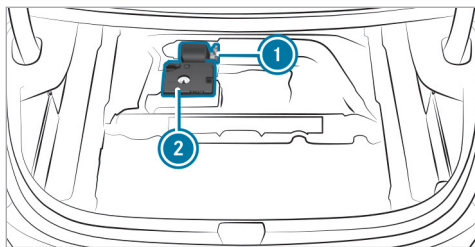

- ① Tire sealant bottle
- ② Tire inflation compressor

Depending on the vehicle version, the TIREFIT kit may also be located in other positions under the trunk floor.

Using the TIREFIT kit

Requirements

- Tire sealant bottle and tire inflation compressor are ready for use (→ page 302).
- TIREFIT sticker is displayed.
- Gloves are present.

You can use TIREFIT tire sealant to seal perforation damage of up to 0.16 in (4 mm), particularly in the tire tread. You can use TIREFIT in outside temperatures down to -4 °F (-20 °C).

⚠ WARNING Risk of accident when using tire sealant

The tire sealant may be unable to seal the tire properly, especially in the following cases:

- There are large cuts or punctures in the tire (larger than damage previously mentioned)
 - The wheel rims have been damaged
 - After journeys with very low tire pressure or with flat tires
- ▶ Do not continue driving.
 - ▶ Consult a qualified specialist workshop.

⚠ WARNING Risk of injury and poisoning from tire sealant

The tire sealant is harmful and causes irritation. Do not allow it to come into contact with

the skin, eyes or clothing, and do not swallow it. Do not inhale tire sealant fumes. Keep the tire sealant away from children.

If you come into contact with the tire sealant, observe the following:

- ▶ Rinse off the tire sealant from your skin immediately using water.
- ▶ If tire sealant gets into your eyes, thoroughly rinse out the eyes using clean water.
- ▶ If tire sealant has been swallowed, immediately rinse out the mouth thoroughly and drink plenty of water. Do not induce vomiting and seek medical attention immediately.
- ▶ Change out of any clothes contaminated with tire sealant immediately.
- ▶ If allergic reactions occur, seek medical attention immediately.

NOTE Overheating due to the tire inflation compressor running too long

Do not run the tire inflation compressor for longer than ten minutes without interruption.

Observe the manufacturer's safety notes on the sticker on the tire inflation compressor.

Have the tire sealant bottle replaced at a qualified specialist workshop every five years.

Do not remove any foreign objects that have pierced the tire.

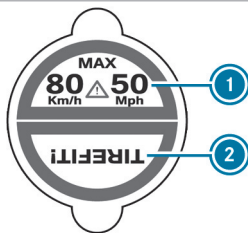

- ▶ Affix part ① of the TIREFIT sticker to the instrument cluster within the driver's field of vision.
- ▶ Affix part ② of the TIREFIT sticker near the valve on the wheel with the defective tire.

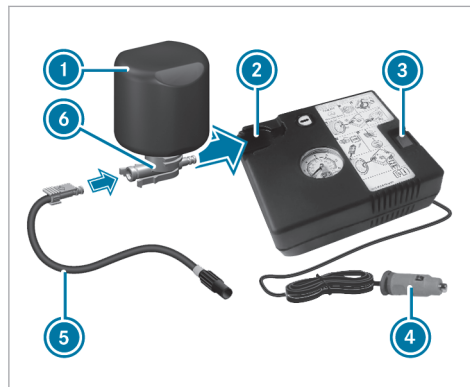

- ▶ Pull plug ④ with the cable and hose ⑤ out of the tire inflation compressor housing.

- ▶ Push the plug of hose ⑤ into flange ⑥ of tire sealant bottle ① until the plug engages.
- ▶ Place tire sealant bottle ① head downwards into recess ② of the tire inflation compressor.

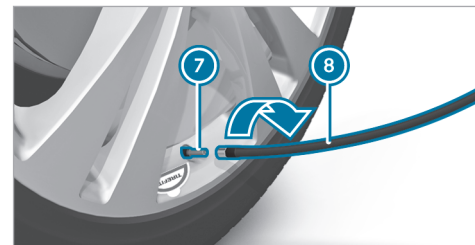

- ▶ Remove the valve cap from valve ⑦ on the defective tire.
- ▶ Screw filling hose ⑧ onto valve ⑦.
- ▶ Insert plug ④ into a 12 V socket in your vehicle.
- ▶ Switch on the vehicle.

- ▶ Switch on the tire inflation compressor using On/Off switch .
- The tire will be inflated. First, tire sealant will be pumped into the tire. The pressure may briefly rise to approximately 500 kPa (5.0 bar/73 psi).

Do not switch off the tire inflation compressor during this phase!

- ▶ Allow the tire inflation compressor to run for a maximum of ten minutes.
- The tire should then have attained a tire pressure of at least 200 kPa (2.0 bar/29 psi).

If tire sealant leaks out, make sure you clean the affected area as quickly as possible. It is preferable to use clean water.

If you get tire sealant on your clothing, have it cleaned as soon as possible with perchloroethylene.

If, after ten minutes, a tire pressure of 200 kPa (2.0 bar/29 psi) has not been attained:

- ▶ Switch off the tire inflation compressor.

- ▶ Unscrew the filling hose from the valve of the defective tire.

Please note that tire sealant may leak out when you unscrew the filling hose.

- ▶ Drive the vehicle forwards or in reverse very slowly for approximately 33 ft (10 m).
 - ▶ Pump up the tire again.
- After a maximum of ten minutes, the tire pressure must be at least 200 kPa (2.0 bar/29 psi).

⚠ WARNING Risk of accident due to the specified tire pressure not being achieved

If the specified tire pressure is not achieved after the specified time, the tire is too badly damaged. The tire sealant cannot repair the tire in this instance.

The braking characteristics as well as the driving characteristics may be greatly impaired.

- ▶ Do not continue driving.
- ▶ Consult a qualified specialist workshop.

If, after ten minutes, a tire pressure of 200 kPa (2.0 bar/29 psi) has been attained:

- ▶ Switch off the tire inflation compressor.
- ▶ Unscrew the filling hose from the valve of the defective tire.

⚠ WARNING Risk of accident from driving with sealed tires

A tire temporarily sealed with tire sealant impairs the handling characteristics and is not suitable for higher speeds.

- ▶ Adapt your driving style accordingly and drive carefully.
- ▶ Do not exceed the maximum speed limit with a tire that has been repaired using tire sealant.

- ▶ Observe the maximum permissible speed of 50 mph (80 km/h) for a tire sealed with tire sealant.

NOTE Staining caused by leaking tire sealant

After use, excess tire sealant may leak out from the filling hose.

- ▶ Therefore, place the filling hose in the plastic bag that contained the TIREFIT kit.

ENVIRONMENTAL NOTE Environmental pollution caused by environmentally irresponsible disposal

Tire sealant contains pollutants.

- ▶ Have the tire sealant bottle disposed of professionally, e.g. at an authorized Mercedes-Benz Center.

- ▶ Stow the tire sealant bottle and the tire inflation compressor.
- ▶ Pull away immediately.

- ▶ Stop driving after approximately ten minutes and check the tire pressure using the tire inflation compressor. The tire pressure must now be at least 130 kPa (1.3 bar/19 psi).

WARNING Risk of accident due to the specified tire pressure not being attained

If the specified tire pressure is not reached, the tire is too badly damaged. The tire sealant cannot repair the tire in this instance.

The braking and driving characteristics may be greatly impaired.

- ▶ Do not continue driving.
- ▶ Consult a qualified specialist workshop.

In cases such as the one mentioned above, contact an authorized Mercedes-Benz Center. Alternatively, call 1-800-FOR-MERCEdes (in the USA) or 1-800-387-0100 (in Canada).

- ▶ **To increase the tire pressure:** switch on the tire inflation compressor.

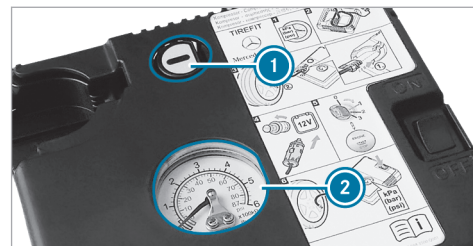

- ▶ **To reduce the tire pressure:** press pressure release button ① next to manometer ②.
- ▶ When the tire pressure is correct, unscrew the filling hose from the valve of the sealed tire.
- ▶ Screw the valve cap onto the valve of the sealed tire.
- ▶ Pull the tire sealant bottle out of the tire inflation compressor. The filling hose should remain on the tire sealant bottle.
- ▶ Drive to the nearest qualified specialist workshop and have the tire, tire sealant bottle and filling hose replaced.

Battery (vehicle)**Notes on the 12-V- battery**

⚠ WARNING Risk of an accident due to work carried out incorrectly on the battery

Work carried out incorrectly on the battery can, for example, lead to a short circuit. This can restrict functions relevant for safety systems and impair the operating safety of your vehicle.

You could lose control of the vehicle in the following situations in particular:

- When braking
- In the event of abrupt steering maneuvers and/or when the vehicle's speed is not adapted to the road conditions
- ▶ In the event of a short circuit or a similar incident, contact a qualified specialist workshop immediately.
- ▶ Do not drive on.
- ▶ Always have work on the battery carried out at a qualified specialist workshop.

- Further information on ABS (→ page 174)
- Further information on ESP® (→ page 175)

For safety reasons, Mercedes-Benz recommends that you only use batteries which have been approved for your vehicle by Mercedes-Benz.

All vehicles except vehicles with a lithium-ion battery

⚠ WARNING Risk of explosion due to electrostatic charge

Electrostatic charge can ignite the highly explosive gas mixture in the battery.

- ▶ To discharge any electrostatic charge that may have built up, touch the metal vehicle body before handling the battery.

The highly flammable gas mixture is created while the battery is charging and during starting assistance.

⚠ WARNING Danger of chemical burns from the battery acid

Battery acid is caustic.

- ▶ Avoid contact with the skin, eyes or clothing.
- ▶ Do not lean over the battery.
- ▶ Do not inhale battery gases.
- ▶ Keep children away from the battery.
- ▶ Immediately rinse battery acid off thoroughly with plenty of clean water and seek medical attention immediately.

All vehicles

🌿 ENVIRONMENTAL NOTE Environmental damage due to improper disposal of batteries



Batteries contain pollutants. It is illegal to dispose of them with the household rubbish.



Dispose of batteries in an environmentally responsible manner. Take discharged batteries to a qualified specialist workshop or to a collection point for used batteries.

If you have to disconnect the 12 -V- battery, contact a qualified specialist workshop.

Comply with safety notes and take protective measures when handling batteries.



Risk of explosion if the 12 -V- battery is used improperly.



Fire, open flame and smoking are prohibited when handling the battery. Avoid creating sparks.



Electrolyte or battery acid is corrosive. Avoid contact with your skin, eyes or clothing. Wear suitable protective clothing, in particular gloves, apron and face mask. Immediately rinse electrolyte or acid

splashes off with clean water. Consult a doctor immediately.



Do not place heavy objects on the surface of the battery or use the battery to support a person in any way.



Wear safety goggles.



Keep children away.



Observe this Operator's Manual.

Observe the following if you do not intend to use the vehicle over an extended period of time:

- **If available:** activate standby mode (→ page 172).
- Alternatively: connect the battery to a battery charger approved by Mercedes-Benz or consult a qualified specialist workshop to disconnect the battery.

Notes on the 48 -V - battery

⚠ WARNING Risk of an accident due to work carried out incorrectly on the battery

Work carried out incorrectly on the battery can, for example, lead to a short circuit. This can restrict functions relevant for safety systems and impair the operating safety of your vehicle.

You could lose control of the vehicle in the following situations in particular:

- When braking
- In the event of abrupt steering maneuvers and/or when the vehicle's speed is not adapted to the road conditions

▶ In the event of a short circuit or a similar incident, contact a qualified specialist workshop immediately.

▶ Do not drive on.

▶ Always have work on the battery carried out at a qualified specialist workshop.

- Further information on ABS (→ page 174)

- Further information on ESP® (→ page 175)



ENVIRONMENTAL NOTE Environmental damage due to improper disposal of batteries



Batteries contain pollutants. It is illegal to dispose of them with the household trash.



Li-ion Dispose of batteries in an environmentally responsible manner. Take discharged batteries to a qualified specialist workshop or to a collection point for used batteries.

Only have work on the 48 -V- battery carried out at a qualified specialist workshop.

Comply with safety notes and take protective measures when handling batteries.



Risk of explosion if the 48 -V- battery is used improperly.



The surface of the 48 -V- battery may be hot.



Fire, open flame and smoking are prohibited when handling the battery. Avoid creating sparks.



Electrolyte or battery acid is corrosive. Avoid contact with your skin, eyes or clothing. Wear suitable protective clothing, in particular gloves, apron and face mask. Immediately rinse off splashes of electrolyte or acid with plenty of clean water. Consult a doctor immediately.



Do not place heavy objects on the surface of the battery or use the battery to support a person in any way.



Do not perform any work on the battery. Always have any work on the battery carried out at a qualified specialist workshop. Do not disconnect the battery yourself. Do not remove the battery yourself. Do not attempt to open the battery.



Keep children away.



Wear safety goggles.



Observe this Operator's Manual.

Observe the following if you do not intend to use the vehicle over an extended period of time:

- **If available:** activate standby mode (→ page 172).

Notes on starting assistance and charging the 12-V-battery

All vehicles

Always use the jump-start connection point in the engine compartment for charging the battery and jump starting.



NOTE Damage to the battery due to over-voltage

When charging using a battery charger without a maximum charging voltage, the battery or the on-board electronics may be damaged.

- ▶ Only use battery chargers with a maximum charging voltage of 14.8 V.

⚠ WARNING Risk of explosion due to igniting hydrogen gas

If you cause a short circuit or sparks occur, the hydrogen gas may ignite when a battery is charging.

- ▶ Ensure that the positive terminal of a connected battery does not come into contact with vehicle parts.
- ▶ Never place metal objects or tools on a battery.
- ▶ When connecting and disconnecting the battery, always observe the sequence of battery terminals described.
- ▶ When jump starting, take care to connect only battery terminals of identical polarity.
- ▶ When jump starting, always observe the sequence described for connecting and disconnecting the jumper cables.

- ▶ Do not connect or disconnect the battery terminals when the engine is running.

⚠ WARNING Risk of explosion due to a mixture of explosive gases

A mixture of explosive gases can escape from the battery during charging and jump starting.

- ▶ Fire, open flames, smoking and creating sparks must be avoided.
- ▶ Make sure that there is sufficient ventilation.
- ▶ Do not stand over the battery.

⚠ WARNING Risk of explosion from a frozen battery

A discharged battery may freeze at temperatures slightly above or below freezing point. During starting assistance or battery charging, battery gas can be released.

- ▶ Always allow a battery to thaw before charging it or performing starting assistance.

If the indicator/warning lamps in the instrument cluster do not light up at low temperatures, it is very likely that the discharged battery has frozen. In this case you must neither charge the battery nor give the vehicle starting assistance.

The service life of a defrosted battery may be drastically shortened. The starting behaviour may deteriorate, in particular at low temperatures.

Having a defrosted battery checked at a qualified specialist workshop is recommended.

All vehicles

- !** **NOTE** Damage caused by numerous or extended attempts to start the engine

Numerous or extended attempts to start the engine may damage the catalytic converter due to non-combusted fuel.

- ▶ Avoid numerous and extended attempts to start the engine.

Observe the following points during starting assistance and when charging the battery:

- Only use undamaged jumper cables/charging cables with a sufficient cross-section and insulated terminal clamps.
- Uninsulated parts of the terminal clamps must not come into contact with other metal parts while the jumper cables/charging cables are connected to the battery/jump-start connection point.
- The jumper cables/charging cables must not touch any parts which may move when the engine is running.
- Make sure that neither you nor the battery are electrostatically charged.
- Avoid fire and naked lights.
- Do not bend over a battery.

When charging the battery also observe the following points:

- Only use chargers tested and approved for Mercedes-Benz.

- Read the charger's Owner's Manual before you charge the battery.

Also observe the following points during starting assistance:

- Starting assistance may only be provided using vehicles, batteries or other jump start devices with a nominal voltage of 12-V-.
- The vehicles must not touch each other.
- **Vehicles with a gasoline engine:** jump-start the vehicle only when the engine and exhaust system are cold.

Starting assistance and charging the 12 -V- battery

Prepare starting assistance/charging process

- ▶ Use the electric parking brake to secure the vehicle.
- ▶ Shift the transmission to position **P**.
- ▶ Switch off the vehicle and all electrical consumers.
- ▶ Open the hood.

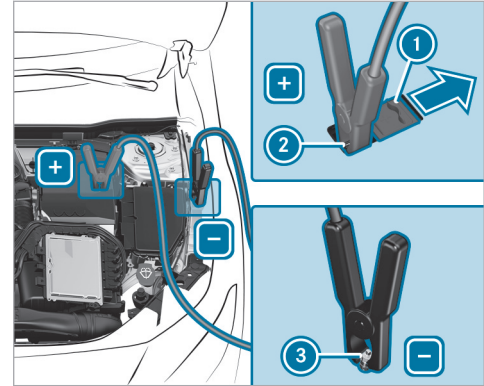

- ▶ Slide cover ① of positive terminal ② on the jump-starting connection point in the direction of the arrow.

Starting assistance

- ▶ Connect the positive terminal of your own vehicle to the jumper cable.
- ▶ Connect the positive terminal of the booster battery to the jumper cable.

- ▶ On the assisting vehicle, let the engine run at idling speed.
- ▶ Connect the negative terminal of the booster battery to the jumper cable.
- ▶ Connect the jumper cable to your vehicle's ground point ③.
- ▶ Start the engine of your own vehicle.
- ▶ Let the engines run for several minutes.
- ▶ Before disconnecting the jumper cable, switch on an electrical consumer in your own vehicle, e.g. the rear window heater or the lighting.

When the starting assistance process is complete:

- ▶ Disconnect the jumper cable from your vehicle's ground point ③.
- ▶ Remove the jumper cable from the negative terminal of the booster battery.
- ▶ Remove the jumper cable from the positive contact of your vehicle.
- ▶ Remove the jumper cable from the positive terminal of the booster battery.

- ▶ After removing the jumper cable, close cover ① of the positive terminal ②.

Further information can be obtained at a qualified specialist workshop.

Charging the 12 V battery

- ▶ Connect the positive terminal of your own vehicle to the charging cable.
- ▶ Connect the positive terminal of the charger to the charging cable.
- ▶ Connect the negative terminal of the charger to the charging cable.
- ▶ Connect the charging cable to your vehicle's ground point ③.
- ▶ Start the charging process.

When the charging process is complete:

- ▶ Disconnect the charging cable from your vehicle's ground point ③.
- ▶ Remove the charging cable from the negative terminal of the charger.
- ▶ Remove the charging cable from the positive terminal of your own vehicle.

- ▶ Remove the charging cable from the positive terminal of the charger.

- ▶ After removing the charging cable, close cover ① of the positive terminal ②.

Replacing the 12 V battery

- ▶ Observe the notes on the 12 V battery (→ page 307).

Mercedes-Benz recommends that you have the 12 V battery replaced at a qualified specialist workshop, e.g. at a Mercedes-Benz Service Center.

If you want to replace the battery yourself, observe the following notes:

- Replace a faulty battery with a battery which meets the specific vehicle requirements.

The vehicle is equipped with a battery with AGM -technology (Absorbent Glass Mat) or a lithium-ion battery. Full vehicle functionality is only guaranteed with an AGM battery or lithium-ion battery. For safety reasons, Mercedes-Benz recommends that you only use batteries

which have been tested and approved for your vehicle by Mercedes-Benz.

- Use the detachable parts such as vent hoses, elbow fittings or terminal covers from the battery which is to be replaced.
- Make sure that the vent hose is always connected to the original opening on the side of the battery.

Install any existing or supplied cell caps.

Otherwise, gases or battery acid could escape.

- Make sure that detachable parts are reconnected in the same way.

Tow starting or towing away

Overview of permissible towing methods (not plug-in hybrid)

! NOTE Damage from automatic braking

If one of the following functions is activated, the vehicle will brake automatically in certain situations:

- Active Brake Assist
- Active Distance Assist DISTRONIC
- HOLD function
- Active Parking Assist

To avoid damage to the vehicle, switch off these systems, e.g. when towing or using a car wash.

Mercedes-Benz recommends transporting your vehicle in case of a breakdown, rather than towing it.

For towing with both axles on the ground, use a tow rope or tow bar. Do not use tow bar systems.

! WARNING Risk of accident when towing with steering wheel locking



When the steering wheel locking is engaged, you can no longer steer the vehicle.

- ▶ Always switch on the vehicle when towing with a tow rope or tow bar.

! NOTE Damage to the vehicle due to towing away incorrectly

- ▶ Observe the instructions and notes on towing away.

Permitted towing methods

Vehicle equipment/towing method			
	Both axles on the ground	Front axle raised	Rear axle raised
Vehicles with automatic transmission	Yes, for a maximum of 31 miles (50 km) at 31 mph (50 km/h)	Yes, for a maximum of 31 miles (50 km) at 31 mph (50 km/h)	Yes, for a maximum of 31 miles (50 km) at 31 mph (50 km/h)
4MATIC vehicles	Yes, for a maximum of 31 miles (50 km) at 31 mph (50 km/h)	No	No

Towing with a raised axle: towing should be performed by a towing company.

Towing the vehicle with both axles on the ground

- ▶ Observe the notes on the permitted towing methods.
- ▶ Make sure that the battery is connected and charged.

Observe the following points when the battery is discharged:

- The vehicle cannot be started.
 - The electric parking brake cannot be released or applied
 - **Vehicles with automatic transmission:** the transmission cannot be shifted to position **N** or **P**.
- i** **Vehicles with automatic transmission:** if the transmission cannot be shifted to position **N**

or if the display does not show anything, transport the vehicle (→ page 316). A towing vehicle with lifting equipment is required for vehicle transportation.

! **NOTE** Damage due to towing away at excessively high speeds or over long distances

The drivetrain could be damaged when towing at excessively high speeds or over long distances.

- ▶ A towing speed of 30 mph (50 km/h) must not be exceeded.
- ▶ A towing distance of 30 miles (50 km) must not be exceeded.

⚠ WARNING Risk of accident when towing a vehicle which is too heavy

If the vehicle to be tow-started or towed away is heavier than the permissible gross mass of your vehicle, the following situations can occur:

- The towing eye may become detached.
 - The vehicle/trailer combination may swerve or rollover.
- ▶ Before tow-starting or towing away, check if the vehicle to be tow-started or towed away exceeds the permissible gross mass.

If a vehicle has to be tow-started or towed away, its gross vehicle weight rating must not exceed the gross vehicle weight rating of the towing vehicle.

- ▶ Information on the gross vehicle weight rating can be found on the vehicle identification plate (→ page 354).
- ▶ **Vehicles with automatic transmission:** do not open the driver's door or front passenger door; the transmission will otherwise automatically shift to position **P**.
- ▶ Install the towing eye (→ page 317).
- ▶ Fasten the towing device.

! NOTE Damage due to incorrect connection of the tow bar

- ▶ Only connect the tow rope or tow bar to the towing eyes.

- ▶ Deactivate the automatic locking mechanism (→ page 81).
- ▶ Do not activate the HOLD function.
- ▶ Deactivate the tow-away alarm (→ page 95).
- ▶ Deactivate Active Brake Assist (→ page 198).
- ▶ **Vehicles with automatic transmission:** shift the transmission to position **N**.

- ▶ Release the electric parking brake.

⚠ WARNING Risk of accidents due to restricted safety-related functions during towing

Safety-relevant functions will be restricted or no longer available in the following situations:

- The vehicle is switched off.
- The brake system or the power steering is malfunctioning.
- The power supply or the on-board electrical system is defective.

If your vehicle is being towed, considerably more force may be required for steering and braking.

In addition, important vehicle display messages will not be visible if the driver display is faulty.

- ▶ Use a tow bar.
- ▶ Before towing, ensure that the driver's display is operational and the steering can move freely.

! **NOTE** Damage due to excessive tractive power

If you pull away sharply, the tractive power may be too high and the vehicles could be damaged.

- ▶ Pull away slowly and smoothly.

Loading up the vehicle for transport

- ▶ Observe the notes on towing (→ page 314).
- ▶ Connect the towing device to the towing eye in order to load up the vehicle.
- ▶ **Vehicles with automatic transmission:** shift the automatic transmission to position **N**.
- ▶ **i Vehicles with automatic transmission:** the automatic transmission may be locked in position **P** in the event of damage to the electrical system. To shift to **N**, provide the on-board electrical system with power (→ page 311).
- ▶ Load the vehicle correctly onto the transporter.

- Ensure that all wheels are on the transportation surface.
- Ensure that the vehicle is parallel to the direction of travel.
- ▶ Put the selector lever into position **P**.
- ▶ Use the electric parking brake to secure the vehicle against rolling away.
- ▶ Stop the vehicle and switch off the power supply.
- ▶ Only secure the vehicle by the wheels.

Vehicles with Adaptive Damping System

! **WARNING** Risk of an accident when transporting vehicles with adaptive damping adjustment

When transporting vehicles with adaptive damping adjustment, the vehicle/trailer combination may begin to rock and start to skid.

- ▶ Load the vehicle correctly onto the transporter.
- ▶ Secure the vehicle on all four wheels with suitable tensioning straps.

! **NOTE** Damage to the vehicle from securing it incorrectly

- ▶ After loading, the vehicle must be secured on all four wheels. Otherwise, the vehicle could be damaged.
- ▶ A minimum distance of 8 in (20 cm) upwards and 4 in (10 cm) downwards must be kept to the transport platform.
- ▶ Load the vehicle correctly onto the transporter.
 - Ensure that all wheels are on the transportation surface.
 - Ensure that the vehicle is parallel to the direction of travel.
- ▶ Put the selector lever into position **P**.
- ▶ Use the electric parking brake to secure the vehicle against rolling away.
- ▶ Stop the vehicle and switch off the power supply.
- ▶ Secure the vehicle at all four wheels.

4MATIC vehicles/vehicles with automatic transmission

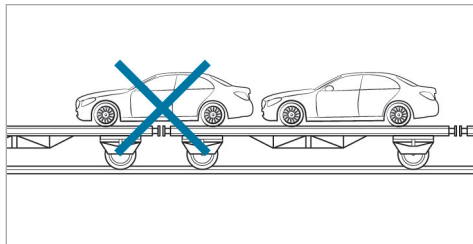

- ▶ Make sure that the front and rear axles come to rest on the same transport vehicle.

! **NOTE** Damage to the drive train due to incorrect positioning of the vehicle

- ▶ Do not position the vehicle above the connection point of the transport vehicle.

Towing eye storage location

The towing eye is located under the trunk floor.

- i** Depending on the vehicle version, the towing eye is located in a different position in the trunk.

Installing and removing the towing eye

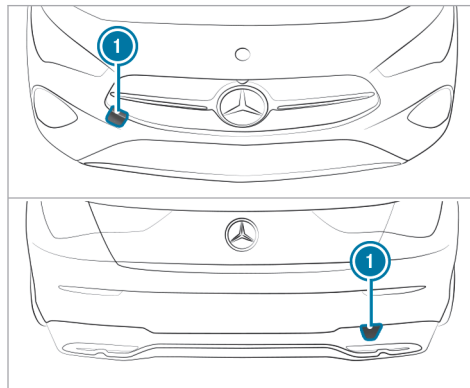

- ▶ Press the cover **1** inwards at the marking and remove.
- ▶ Screw in the towing eye clockwise to the end stop.
- ▶ After removing the towing eye, reattach the cover **1** in the bumper.

! **NOTE** Damage to the vehicle due to incorrect use of the towing eye or trailer hitch

When a towing eye or trailer hitch is used to recover a vehicle, the vehicle may be damaged in the process.

- ▶ Only use the towing eye or trailer hitch to tow away or tow start the vehicle.
- ▶ Do not use the towing eye or trailer hitch to tow the vehicle during recovery.

Tow-starting the vehicle

Vehicles with automatic transmission

- ▶ Observe the following note on material damage:

! **NOTE** Damage to the automatic transmission due to tow starting

The automatic transmission may be damaged in the process of tow starting vehicles with automatic transmission.

- ▶ Vehicles with automatic transmission must not be tow started.

Electrical fuses

Notes on electrical fuses

! **WARNING** Risk of accident and injury due to overloaded lines

If you manipulate or bridge a faulty fuse or if you replace it with a fuse with a higher amperage, the electric line could be overloaded.

This could result in a fire.

- ▶ Always replace faulty fuses with specified new fuses containing the correct amperage.

! **NOTE** Damage due to incorrect fuses

Using incorrect fuses can result in damage to electrical components or systems or their functions being considerably restricted.

- ▶ Use only fuses approved for Mercedes-Benz with the respective specified fuse rating.

Replace blown fuses with equivalent fuses, identifiable by their color and label. The fuse ratings and further information to be observed can be found in the fuse assignment diagram.

Fuse assignment diagram: on the fuse box in the engine compartment (→ page 319).

! **NOTE** Damage or malfunctions caused by moisture

Moisture may cause damage to the electrical system or cause it to malfunction.

- ▶ When the fuse box is open, make sure that no moisture can enter the fuse box.

- ▶ When closing the fuse box, make sure that the seal of the lid is positioned correctly on the fuse box.

If the newly inserted fuse also blows, have the cause determined and rectified at a qualified specialist workshop.

Ensure the following before replacing a fuse:

- The vehicle is secured against rolling away.
- All electrical consumers are switched off.
- The vehicle is switched off.

The electrical fuses are located in various fuse boxes:

- Fuse box in the engine compartment on the left-hand side of the vehicle, when viewed in the direction of travel (→ page 319)
- Fuse box in the front passenger footwell (→ page 319)
- Fuse box in the center of the trunk (→ page 320)

Opening and closing the fuse box in the engine compartment

Requirements:

- A dry cloth and a screwdriver are available.

Observe the notes on electrical fuses (→ page 318).

Opening

⚠ WARNING Risk of injury from using the windshield wipers when the hood is open

If the windshield wipers start moving when the hood is open, you could be trapped by the wiper linkage.

- ▶ Always switch off the windshield wipers and vehicle before opening the hood.

- ▶ Open the hood.

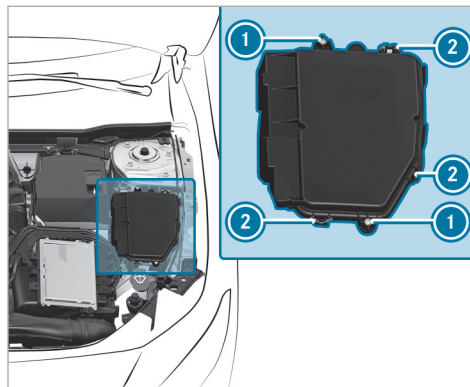

- ▶ Remove any existing moisture from the fuse box using a dry cloth.
- ▶ Loosen screws ①.
- ▶ Press clips ② and lift the fuse box lid up and out.

The fuse assignment diagram is in a recess on the side of the fuse box.

Closing

- ▶ Check whether the seal is positioned correctly in the lid.
- ▶ Place the lid on the fuse box.
- ▶ Make sure that clips ② engage.
- ▶ Tighten screws ①.
- ▶ Close the hood.

Opening and closing the fuse box in the front passenger footwell

Requirements

Observe the notes on electrical fuses (→ page 318).

Opening

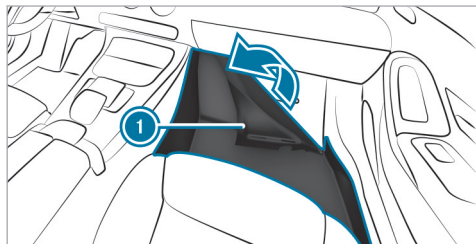

- ▶ Lift carpet ① in the direction of the arrow.

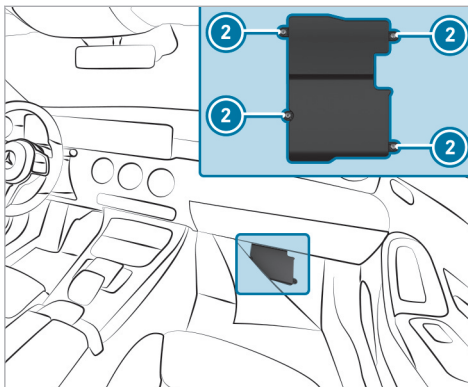

- ▶ Loosen screws ② and remove fuse box lid from the top.

Closing

- ▶ Place the lid on the fuse box.
- ▶ Tighten screws ②.
- ▶ Fold back the carpet.

Opening and closing the fuse box in the boot

Requirements

Observe the notes on electrical fuses (→ page 318).

- ▶ Open the boot floor .

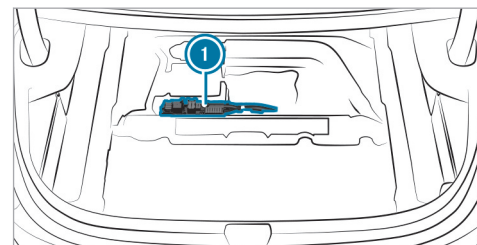

Fuse box ① is located in the center underneath the boot floor.

Notes on noise or unusual handling characteristics

Make sure there are no vibrations, noises or unusual handling characteristics when the vehicle is in motion. This may indicate that the wheels or tires are damaged. Hidden tire damage could also be causing the unusual handling characteristics.

If you suspect that a tire is defective, reduce your speed immediately and have the tires and wheels checked at a qualified specialist workshop.

Notes on regularly inspecting wheels and tires

⚠ WARNING Risk of injury through damaged tires

Damaged tires can cause tire pressure loss.

- ▶ Check the tires regularly for signs of damage and replace any damaged tires immediately.

⚠ WARNING Risk of hydroplaning due to insufficient tire tread

Insufficient tire tread will result in reduced tire grip. There is a risk of an accident.

On a wet road surface the risk of hydroplaning is increased, in particular where speed is not adapted to suit the conditions.

- ▶ Check the tread depth and the condition of the tire contact surface across the entire width of all tires on a regular basis.

Minimum tread depth for

- summer tires: $\frac{1}{8}$ in (3 mm)
- M+S tires: $\frac{1}{6}$ in (4 mm)
- ▶ For safety reasons, replace the tires before the legally-prescribed limit for the minimum tread depth is reached.
- ▶ Replace the tires immediately if the legally-prescribed limit for the minimum tread depth is reached.

Carry out the following checks on all wheels regularly, at least once a month or as required, for example, prior to a long journey or driving off-road:

- Check the tire pressure (→ page 322).
- Visually inspect wheels and tires for damage.
- Check the valve caps.
- Visual check of the tire tread depth and the tire contact surface across the entire width.

The minimum tread depth for summer tires is $\frac{1}{8}$ in (3 mm) and for winter tires $\frac{1}{6}$ in (4 mm).

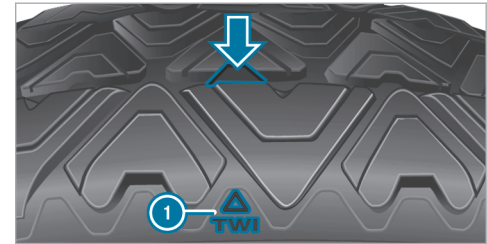

Six marks ① show where the bar indicators (arrow) are integrated into the tire tread. They are

visible once a tire tread depth of approximately $\frac{1}{16}$ in (1.6 mm) has been reached.

Notes on snow chains

⚠ WARNING Risk of accident due to incorrectly installed snow chains

If you have installed snow chains to the rear wheels, they may drag against the vehicle body or chassis components.

- ▶ Never install snow chains on the rear wheels.
- ▶ Only install snow chains on the front wheels in pairs.

! NOTE Damage to vehicle body or suspension components caused by installed snow chains

On 4MATIC vehicles, if you install snow chains on the rear wheels, you can damage vehicle body or suspension components.

- ▶ On 4MATIC vehicles, only install snow chains on the front wheels.

Please observe the following notes when using snow chains:

- Snow chains are only permissible for certain wheel/tire combinations. You can obtain information about this from a Mercedes-Benz Service Center.
- For safety reasons, only use snow chains that have been specifically approved for your vehicle by Mercedes-Benz, or snow chains with the same quality standard.
- The maximum permissible speed with snow chains is 30 mph (50 km/h).
- **Vehicles with Active Parking Assist:** Do not use Active Parking Assist with snow chains.
- ⓘ You can deactivate ESP® for starting off (→ page 176). This allows the wheels to spin, achieving increased tractive force.

Tire pressure

Notes on tire pressure

⚠ WARNING Risk of an accident owing to insufficient or excessive tire pressure

Tires with an insufficient or excessive pressure pose the following dangers:

- The tires can burst.
 - The tires can wear excessively and/or unevenly.
 - The driving characteristics as well as the steering- and braking may be greatly impaired.
- ▶ Observe the recommended tire pressure and check the tire pressure of all tires including the spare wheel:
- monthly
 - when the load changes
 - before embarking on a longer journey

- when the operating conditions change, e.g. off-road driving
 - when driving at over 250 km/h
- ▶ Adjust the tire pressure if necessary.

Too high or too low tire pressure can:

- Shorten the service life of the tires.
- Lead to tire damage.
- Adversely affect driving characteristics and thus driving safety, e.g. due to aquaplaning.

⚠ WARNING Risk of accident due to too low a tire pressure

Tires with pressure that is too low can overheat and burst as a consequence.

In addition, they also suffer from irregular wear, which can significantly impair the braking properties and the handling characteristics.

- ▶ Avoid excessively low tire pressure.

Too low tire pressure can cause:

- Tire defects as a result of overheating
- Impaired handling characteristics
- Irregular wear
- Increased fuel consumption

⚠ WARNING Risk of accident due to too high a tire pressure

Tires with excessively high pressure can burst. In addition, they also suffer from irregular wear, which can significantly impair the braking properties and the handling characteristics.

- ▶ Avoid excessively high tire pressures.

Too high tire pressure can cause:

- Increased braking distance
- Impaired handling characteristics
- Irregular wear
- Impaired driving comfort
- Susceptibility to damage

⚠ WARNING Risk of accident due to repeated pressure drop in the tires

The wheels, valves or tires could be damaged. Too low a tire pressure can lead to the tires bursting.

- ▶ Examine the tires for foreign objects.
- ▶ Check whether the tire has a puncture or the valve has a leak.
- ▶ If you are unable to rectify the damage, contact a qualified specialist workshop.

You can find information on tire pressure for the vehicle's factory-installed tires on the following labels:

- Tire and Loading Information placard on the B-pillar of your vehicle (→ page 328).
- Tire pressure table on the inside of the fuel filler flap (→ page 324).

Also observe the maximum tire pressure (→ page 335).

Use a suitable pressure gauge to check the tire pressure. The outer appearance of a tire does not give any reliable indication of the tire pressure.

Only correct the tire pressure when the tires are cold. Conditions for cold tires:

- The vehicle has been parked with the tires out of direct sunlight for at least three hours.
- The vehicle has travelled less than 1 mile (1.6 km).

The vehicle's tires heat up when driving. As the temperature of a tire increases, so does the tire pressure.

Vehicles with a tire pressure monitoring system: you can have the tire pressure shown in the driver display (→ page 326).

The tire pressure recommended for increased load/speed in the tire pressure table can affect the ride comfort.

⚠ WARNING Risk of accident due to unsuitable accessories on tire valves

If you mount unsuitable accessories onto tire valves, the tire valves may be overloaded and malfunction, which can cause tire pressure loss.

- ▶ Only screw standard valve caps or valve caps specifically approved by Mercedes-Benz for your vehicle onto the tire valve.

Tire pressure table

The tire pressure table is on the inside of the fuel filler flap.

- ⓘ The data shown in the images is example data.

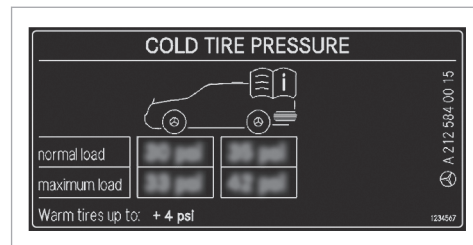

The tire pressure table shows the recommended tire pressure for all tires approved for this vehicle. The recommended tire pressures apply for cold tires under various operating conditions, i.e. vehicle load and/or speed.

If one or more tire sizes precede a tire pressure, the following tire pressure information is only valid for those tire sizes and their respective load condition.

The load conditions "partially laden" and "fully laden" are defined in the table for different numbers of passengers and amounts of luggage. The actual number of seats may differ from this.

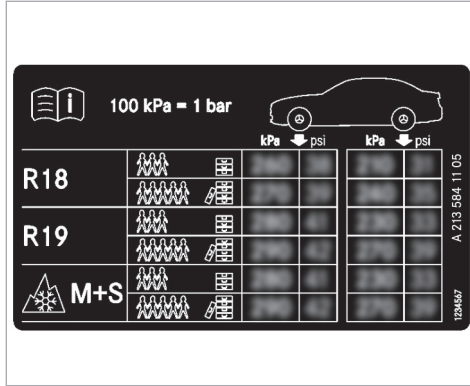

Some tire pressure tables only show the rim diameter instead of the complete tire size, e.g. **R18**. The rim diameter is part of the tire size. The rim diameter can be found on the sidewall of the tire (→ page 335).

- Tire and loading information placard (→ page 328)
- Maximum tire pressure (→ page 335)

Checking the tire pressure manually

- ▶ Read the tire pressure recommended for the current operating conditions from the tire and loading information placard or the tire pressure table. Observe the notes on tire pressure.
- ▶ Remove the valve cap of the tire to be checked.
- ▶ Press the tire pressure gauge securely onto the valve.
- ▶ Read the tire pressure.
- ▶ If the tire pressure is lower than the recommended value, increase the tire pressure to the recommended value.
- ▶ If the tire pressure is higher than the recommended value, release air. To do so, press down the metal pin in the valve, e.g. using the tip of a pen. Then check the tire pressure again using the tire pressure gauge.
- ▶ Screw the valve cap onto the valve.

Further related subjects:

- Notes on tire pressure (→ page 322)
- Tire pressure table (→ page 324)

- Tire and loading information placard (→ page 328)

Tire pressure monitoring system

Function of the tire pressure monitoring system

⚠ DANGER Risk of accident due to incorrect tire pressure

Each tire, including the spare (if provided), should be checked monthly when cold and inflated to the inflation pressure recommended by the vehicle manufacturer on the vehicle placard or tire inflation pressure label. (If your vehicle has tires of a different size than the size indicated on the vehicle placard or tire inflation pressure label, you should determine the proper tire inflation pressure for those tires.)

As an added safety feature, your vehicle has been equipped with a tire pressure monitoring system (TPMS) that illuminates a low tire pressure telltale when one or more of your tires is significantly under-inflated. Accordingly, when

the low tire pressure telltale illuminates, you should stop and check your tires as soon as possible, and inflate them to the proper pressure. Driving on a significantly under-inflated tire causes the tire to overheat and can lead to tire failure. Under-inflation also reduces fuel efficiency and tire tread life, and may affect the vehicle's handling and stopping ability. Please note that the TPMS is not a substitute for proper tire maintenance, and it is the driver's responsibility to maintain correct tire pressure, even if under-inflation has not reached the level to trigger illumination of the TPMS low tire pressure telltale.

Your vehicle has also been equipped with a TPMS malfunction indicator to indicate when the system is not operating properly. The TPMS malfunction indicator is combined with the low tire pressure telltale. When the system detects a malfunction, the telltale will flash for approximately one minute and then remain continuously illuminated. This sequence will continue upon subsequent vehicle start-ups as long as the malfunction exists.

When the malfunction indicator is illuminated, the system may not be able to detect or signal low tire pressure as intended. TPMS malfunctions may occur for a variety of reasons, including the installation of replacement or alternate tires or wheels on the vehicle that prevent the TPMS from functioning properly.

The system checks the tire pressure and the temperature of the tires installed on the vehicle by means of a tire pressure sensor.

The tire pressure and the tire temperature are displayed on the driver display.

In the event of significant pressure loss or excessive temperature of the tires, you will be warned by display messages (→ page 409) or the warning light  on the driver display (→ page 432).

The tire pressure monitoring system serves solely as an aid. It is the driver's responsibility to set the tire pressure to the recommended cold tire pressure suitable for the operating situation.

In most cases, the tire pressure monitoring system will automatically update the new reference

values after you have changed the tire pressure. You can, however, also update the reference values by restarting the tire pressure monitoring system manually (→ page 327).

System limits

The system may be impaired or inoperative in the following situations in particular:

- Incorrect reference values were taught in.
- Sudden pressure loss caused, e.g. by a foreign object penetrating the tire.
- There is a malfunction caused by another radio signal source.

■ Checking the tire pressure with the tire pressure monitoring system

Requirements:

- The vehicle is switched on.

Driver display:

  **Service**

 Press  to confirm.

One of the following messages will appear:

- Current tire pressure at each wheel:

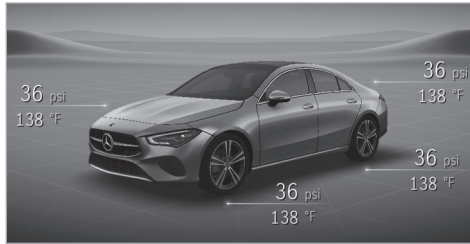

- **Tire pressure displayed after driving for a few minutes.:** Current values are not yet known to the system. The pressure/temperature values for each tire will be displayed as soon as they are known to the system.
 - **Tire Pressure Monitor Active:** The teach-in process of the system is not yet complete. The tire pressures are already being monitored.
- ▶ Compare the current tire pressure with the recommended tire pressure for the current

operating status (→ page 324). Additionally, observe the notes on cold tires (→ page 322).

- ⓘ The values displayed on the driver display may deviate from those of the tire pressure gauge as they relate to sea level. At high elevations, the tire pressure values indicated by a pressure gauge will be higher than those shown on the driver display.

Bear in mind the following related topic:

- Notes on tire pressure (→ page 322)

Restarting the tire pressure monitoring system

Requirements

- The recommended tire pressure is correctly set for the respective operating condition at each of the four wheels (→ page 322).

Restart the tire pressure monitoring system in the following situations:

- The tire pressure has changed.
- The wheels or tires have been changed or newly installed.

Driver display:

▶ ▶ **Service**

- ▶ Show tire pressure: press **OK**.
- ▶ Show options: press **OK** again.
- ▶ Select **Tire Pressure** and confirm with **OK**. The **Use current pressures as new reference values?** message will appear on the driver display.
- ▶ Select **Yes** and confirm the restart with **OK**. The **Tire Pressure Monitor Restarted** message will appear on the driver display.

Current warning messages will be deleted and the yellow warning lamp will go out.

After you have driven for a few minutes, the system will check whether the current tire pressures are within the specified range. The current tire pressures will then be accepted as reference values and monitored.

If the tire pressure levels are not within the specified range, the **Please Correct Tire Pressure** message will appear.

Bear in mind the following related topic:

- Notes on tire pressure (→ page 322)

Loading the vehicle

Notes on the Tire and Loading Information placard

⚠ WARNING Risk of accident from overloaded tires

Overloaded tires may overheat and burst as a consequence. Overloaded tires can also impair the steering and handling characteristics and lead to brake failure.

- ▶ Observe the load rating of the tires.
- ▶ The load rating must be at least half the permissible axle load of the vehicle.
- ▶ Never overload the tires by exceeding the maximum load.

The Tire and Loading Information placard is on the B-pillar on the driver's side of the vehicle.

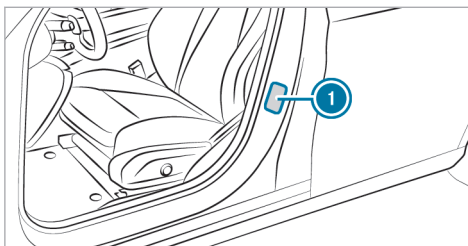

① Tire and Loading Information placard

TIRE AND LOADING INFORMATION		RENSEIGNEMENTS SUR LES PNEUS ET LE CHARGEMENT	
SEATING CAPACITY NOMBRE DE PLACES	TOTAL	FRONT AVANT	MIDDLE MI EU
7	2	3	REAR ARRIERE
The combined weight of occupants and cargo should never exceed Le poids total des occupants et du chargement ne doit jamais dépasser		XXX kg or XXX lbs. ¹ kg ou lbs.	
TIRE PNEU	SIZE DIMENSIONS	COLD TIRE PRESSURE PRESSION DES PNEUS À FROID	SEE OWNER'S MANUAL FOR ADDITIONAL INFORMATION
FRONT AVANT	255/40 ZR18 99Y XL	200 KPA, 29 PSI	VOIR LE MANUEL DE L'USAGER POUR PLUS DE RENSEIGNEMENTS
REAR ARRIERE	285/35 ZR18 101Y XL	200 KPA, 29 PSI	
SPARE DE SECOURS	175/55-18 95P	420 KPA, 60 PSI	

① The data shown in the illustration are sample data.

The Tire and Loading Information placard shows the following information:

- Maximum number of seats ② according to the maximum number of people permitted to travel in the vehicle.

- Maximum permissible load ③ comprises the gross weight of all vehicle occupants, luggage and additional load.
- Recommended tire pressure ① for cold tires. The recommended tire pressures are valid for the maximum permissible load and up to the maximum permissible vehicle speed.

Please also note:

- Information on permissible weights and loads on the vehicle identification plate (→ page 354).
- Information on the tire pressure in the tire pressure table (→ page 324).

Further related subjects:

- Determining the maximum permissible load (→ page 329).
- Notes on the tire pressure (→ page 322).

Steps for determining the correct load limit

The following steps were developed according to the regulations of Title 49, Code of U.S. Federal

Regulations, Part 575, which are binding on all manufacturers, and the National Traffic and Motor Vehicle Safety Act of 1966.

- ▶ (1): Locate the statement "The combined weight of occupants and cargo should never exceed XXX kg or XXX lbs." on your vehicle's placard.
- ▶ (2): Determine the combined weight of the driver and passengers that will be riding in your vehicle.
- ▶ (3): Subtract the combined weight of the driver and passengers from XXX kg or XXX lbs.
- ▶ (4): The resulting figure equals the available amount of cargo and luggage load capacity. For example, if the "XXX" amount equals 1400 lbs. and there will be five 150 lb passengers in your vehicle, the amount of available cargo and luggage load capacity is 650 lbs. (1400 - 750 (5 x 150) = 650 lbs.)
- ▶ (5): Determine the combined weight of luggage and cargo being loaded on the vehicle. That weight may not safely exceed the available cargo and luggage load capacity calculated in Step 4.

- ▶ (6): If your vehicle will be towing a trailer, load from your trailer will be transferred to your vehicle. Consult this manual to determine how this reduces the available cargo and luggage load capacity of your vehicle.

- ▶ ⓘ Not all vehicles are permitted to tow a trailer. Towing a trailer is only permitted if a trailer-hitch is installed. Please consult an authorized Mercedes-Benz dealer if you have any questions about towing a trailer with your vehicle.

Even if you have calculated the total load carefully, you should still make sure that the maximum permissible gross weight and the maximum gross axle weight rating of your vehicle are not exceeded. Details can be found on the vehicle identification plate.

- ▶ Have your loaded vehicle – including driver, occupants and load – weighed on a vehicle weighbridge. The measured values may not exceed the maximum permissible values stated on the vehicle identification plate.

Further related subjects:

- Calculation example for determining the maximum load (→ page 330)
- Tire and loading information placard (→ page 328)
- Tire pressure table (→ page 324)
- Vehicle identification plate (→ page 354)

Calculation example for determining the maximum payload

The following table shows examples of how to calculate total load capacities and payloads with varying seating configurations and different occupant numbers and weights. The following examples use a maximum payload of 1500 lbs

(680 kg). **This is for illustration purposes only.** Make sure you are using the actual maximum payload for your vehicle as stated in the Tire and Loading Information table of your vehicle (→ page 328).

The higher the weight of all the occupants, the lower the maximum luggage load.

Step 1

	Example 1	Example 2
Combined maximum weight of occupants and payload (data from the Tire and Loading Information table)	1500 lbs (680 kg)	1500 lbs (680 kg)

Step 2

	Example 1	Example 2
Number of persons in the vehicle (driver and passengers)	5	1
Distribution of vehicle occupants	Front: 2 Rear: 3	Front: 1
Weight of vehicle occupants	Occupant 1: 150 lbs (68 kg) Occupant 2: 180 lbs (82 kg) Occupant 3: 160 lbs (73 kg) Occupant 4: 140 lbs (63 kg) Occupant 5: 120 lbs (54 kg)	Occupant 1: 200 lbs (91 kg)
Total weight of all vehicle occupants	750 lbs (340 kg)	200 lbs (91 kg)

Step 3

	Example 1	Example 2
Permissible payload (maximum permissible gross vehicle weight from the Tire and Loading Information table minus the total weight of all occupants)	1500 lbs (680 kg) - 750 lbs (340 kg) = 750 lbs (340 kg)	1500 lbs (680 kg) - 200 lbs (91 kg) = 1300 lbs (589 kg)

Tire labeling

Overview of tire labeling

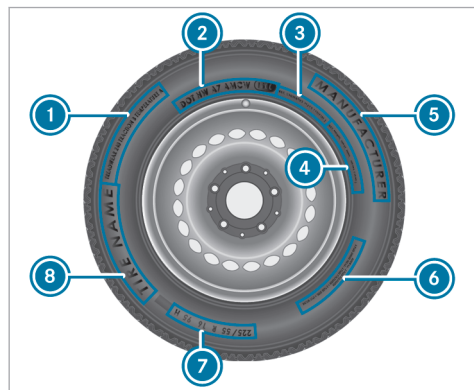

- ① Uniform Tire Quality Grading Standards
- ② DOT (Department of Transportation), (TIN) Tire Identification Number
- ③ Maximum tire load (→ page 334)
- ④ Maximum tire pressure (→ page 335)

- ⑤ Manufacturer
- ⑥ Tire characteristics (→ page 335)
- ⑦ Tire size designation, load-bearing capacity, speed rating and load index (→ page 335)
- ⑧ Tire name
- ① The data shown in the illustration is example data.

Tire quality grading

In accordance with the US Department of Transportation's "Uniform Tire Quality Grading Standards," tire manufacturers are required to grade their tires on the basis of the following three performance factors:

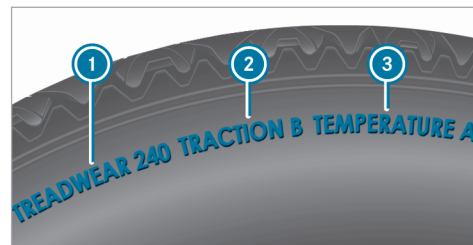

- ① Tread wear grade
- ② Traction grade
- ③ Temperature grade
- ① The data shown in the illustration is example data.
- ① The classification is not legally stipulated for Canada, but it is generally stated.

Tread wear grade

The treadwear grade is a comparative rating based on the wear rate of the tire when tested under controlled conditions on a specified government test course. For example, a tire graded 150 would wear one and one-half (1 1/2) times as

well on the government course as a tire graded 100.

The relative performance of tires depends upon the actual conditions of their use, however, and may depart significantly from the norm due to variations in driving habits, service practices and differences in road characteristics and climate.

Traction grade

⚠ DANGER Risk of accident due to inadequate traction

The traction grade assigned to this tire is based on straight-ahead braking traction tests.

- ▶ Always adapt your driving style and drive at a speed to suit the prevailing traffic and weather conditions.

! NOTE Damage to the drivetrain from wheelspin

- ▶ Avoid wheelspin.

The traction grades, from highest to lowest, are AA, A, B, and C. Those grades represent the tire's ability to stop on wet pavement as measured under controlled conditions on specified government test surfaces of asphalt and concrete. A tire marked C may have poor traction performance.

Temperature grade

⚠ WARNING Risk of accident from tire overheating and tire failure

Excessive speed, underinflation, or excessive loading, either separately or in combination, can cause excessive heat build-up and possible tire failure.

- ▶ Observe the recommended tire pressure.
- ▶ Regularly check the pressure of all the tires.
- ▶ Adjust the tire pressure, if necessary.

The temperature grades are A (the highest), B, and C, representing the tire's resistance to the generation of heat and its ability to dissipate heat when tested under controlled conditions on a specified indoor laboratory test wheel. Sustained

high temperature can cause the material of the tire to degenerate and reduce tire life, and excessive temperature can lead to sudden tire failure. The grade C corresponds to a level of performance which all passenger car tires must meet under the Federal Motor Safety Standard No. 109. Grades B and A represent higher levels of performance on the laboratory test wheel than the minimum required by law.

DOT, Tire Identification Number (TIN)

US tire regulations stipulate that every tire manufacturer or retreader must imprint a TIN in or on the side wall of each tire produced.

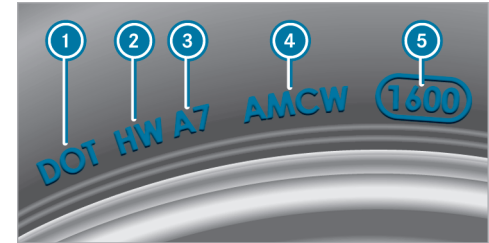

① The data in the illustration is shown as an example.

The TIN is a unique identification number to identify tires, and comprises the following:

- **DOT (Department of Transportation):** tire marking ① indicating that the tire complies with the requirements of the US Department of Transportation.
- **Manufacturer identification code:** the manufacturer identification code ② contains details of the tire manufacturer. New tires have a code with two symbols. Retreaded tires have a code with four symbols. Further information on retreaded tires (→ page 340).
- **Tire size:** the marking ③ states the tire size.
- **Tire type code:** the tire type code ④ can be used by the manufacturer as a code to describe specific characteristics of the tire.
- **Manufacturing date:** the manufacturing date ⑤ provides information about the age of a tire. The 1st and 2nd digits represent the calendar week and the 3rd and 4th digits state

the year of manufacture (e.g. "3208" represents the 32nd week of 2008).

Information on the maximum tire load

⚠ WARNING Risk of accident from overloaded tires

Overloaded tires may overheat and burst as a consequence. Overloaded tires can also impair the steering and handling characteristics and lead to brake failure.

- ▶ Observe the load rating of the tires.
- ▶ The load rating must be at least half the permissible axle load of the vehicle.
- ▶ Never overload the tires by exceeding the maximum load.



① The data in the illustration is shown as an example.

Maximum tire load ① is the maximum permissible weight for which the tire is approved.

Do not overload the tires by exceeding the maximum permissible load limit. The maximum permissible load can be found on the vehicle's Tire and Loading Information table on the B-pillar on the driver's side (→ page 328).

Information on maximum tire pressure

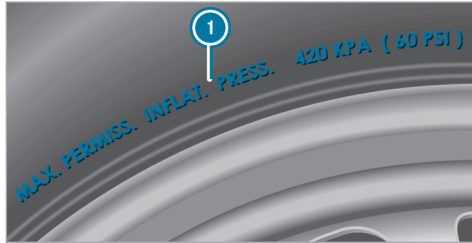

i The data in the illustration is shown as an example.

Do not exceed the maximum tire pressure **1** permitted for the tire. Always observe the recommended tire pressure for your vehicle when adjusting the tire pressure (→ page 324).

Information on tire composition



i The data in the illustration is shown as an example.

It describes the type of tire cord and the number of layers in the side wall **1** and under the tire tread **2**.

Tire size, load-bearing capacity, speed rating and load index

⚠ WARNING Risk of injury through exceeding the specified tire load-bearing capacity or the permissible speed rating

Exceeding the specified tire load rating or the permissible speed rating may lead to tire damage and to the tires bursting.

- ▶ Therefore, only use tire types and sizes approved for your vehicle model.
- ▶ Observe the tire load rating and speed rating required for your vehicle.

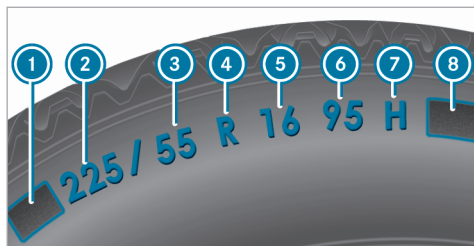

- ① Preceding letter
- ② Nominal tire width in millimeters
- ③ Aspect ratio in %
- ④ Tire code
- ⑤ Rim diameter
- ⑥ Load-bearing index
- ⑦ Speed rating
- ⑧ Load index

⑨ The data in the illustration is shown as an example.

Information about interpreting tire data can be obtained from any qualified specialist workshop.

Preceding letter ①:

- None: passenger car tires according to European manufacturing standards.
- "P": passenger car tires according to US manufacturing standards.
- "LT": light truck tires according to US manufacturing standards.
- "T": compact emergency spare wheels with high tire pressure that are only designed for temporary use in an emergency.

Aspect ratio ③:

Ratio between tire height and tire width in percent (tire height divided by tire width).

Tire code ④ (tire type):

- "R": radial tire
- "D": bias ply tire
- "B": bias radial tire
- "ZR": radial tire with a maximum permissible speed above 149 mph (240 km/h) (optional)

Rim diameter ⑤:

The diameter of the bead seat (not the diameter of the rim flange). The rim diameter is specified in inches (in).

Load-bearing index ⑥:

Numerical code that specifies the maximum load-bearing capacity of a tire (e.g. "91" corresponds to 1356 lbs (615 kg)).

The load-bearing capacity of the tire must be at least half the gross axle weight rating of your vehicle. Do not overload the tires by exceeding the maximum permissible payload.

See also:

- Maximum permissible payload in the Tire and Loading Information table (→ page 328)
- Maximum tire load (→ page 334)
- Load index

Speed rating ⑦:

Specifies the maximum permissible speed of the tire.

- i** An electronic speed limiter prevents your vehicle from exceeding a speed of 130 mph (210 km/h).

Make sure that your tires have the required speed rating. You can obtain information on the required speed rating from a Mercedes-Benz service center.

Summer tires

Index	Speed rating
Q	up to 100 mph (160 km/h)
R	up to 106 mph (170 km/h)
S	up to 112 mph (180 km/h)
T	up to 118 mph (190 km/h)
H	up to 130 mph (210 km/h)
V	up to 149 mph (240 km/h)
W	up to 168 mph (270 km/h)

¹ "ZR" stated in the tire code.

² Or "M+S"  for winter tires.

Index	Speed rating
Y	up to 186 mph (300 km/h)
ZR...Y ¹	up to 186 mph (300 km/h)
ZR... (..Y) ¹	over 186 mph (300 km/h)
ZR ¹	over 149 mph (240 km/h)

- Specifying the speed rating as the "ZR" index in the tire code **4** is optional for tires up to 186 mph (300 km/h).
- If your tire code **4** includes "ZR" and there is no speed rating **7**, find out the maximum permissible speed from the tire manufacturer.
- If the load-bearing index **6** and speed rating **7** are in brackets, the maximum permissible speed of your tire is above 186 mph (300 km/h). To find out the maximum permissible speed, ask the tire manufacturer.

All-weather tires and winter tires

Index	Speed rating
Q M+S ²	up to 100 mph (160 km/h)
T M+S ²	up to 118 mph (190 km/h)
H M+S ²	up to 130 mph (210 km/h)
V M+S ²	up to 149 mph (240 km/h)

Winter tires bear the snowflake symbol  and fulfill the requirements of the Rubber Manufacturers Association (RMA) and the Rubber Association of Canada (RAC) regarding the tire traction on snow.

Load index **8**:

- No specification given: standard load (SL) tire
- "XL" or "Extra Load": extra load tire or reinforced tire
- "Light Load": light load tire

- "C", "D", "E": a load range that depends on the maximum load the tire can carry at a certain pressure.

Definition of terms for tires and loading

Tire structure and characteristics: describes the number of layers or the number of rubber-coated belts in the tire contact surface and the tire wall. These are made of steel, nylon, polyester and other materials.

Bar: metric unit for tire pressure. 14.5038 pounds per square inch (psi) and 100 kilopascal (kPa) is the equivalent of one bar.

DOT (Department of Transportation): DOT-marked tires fulfill the requirements of the US Department of Transportation.

Average weight of the vehicle occupants: the number of vehicle occupants for which the vehicle is designed, multiplied by 150 lb (68 kg).

Uniform tire quality grading standards: a uniform standard to grade the quality of tires with regard to tread quality, tire traction and temperature characteristics. The quality grading assessment is

made by the manufacturer following specifications from the U.S. government. The quality grade of a tire is imprinted on the side wall of the tire.

Recommended tire pressure: the recommended tire pressure is the tire pressure specified for the tires fitted to the vehicle at the factory.

The tire and load information table contains the recommended tire pressure for cold tires, the maximum permissible load and the maximum permissible vehicle speed.

The tire pressure table contains the recommended tire pressure for cold tires under various operating conditions, i.e. loading and/or speed of the vehicle.

Increased vehicle weight due to optional equipment: the combined weight of all standard and optional equipment available for the vehicle, regardless of whether it is actually installed on the vehicle or not.

Rim: the part of the wheel on which the tire is mounted.

GAWR (Gross Axle Weight Rating): the GAWR is the maximum gross axle weight rating. The actual load on an axle must never exceed the gross axle

weight rating. The gross axle weight rating can be found on the vehicle identification plate on the B-pillar on the driver's side.

Speed rating: the speed rating is part of the tire identification. It specifies the speed range for which a tire is approved.

GVW (Gross Vehicle Weight): the gross vehicle weight comprises the weight of the vehicle including fuel, tools, spare wheel, fitted accessories, occupants, luggage and the trailer tongue weight, if applicable. The gross vehicle weight must not exceed the gross vehicle weight rating GVWR as specified on the vehicle identification plate on the B-pillar on the driver's side.

GVWR (Gross Vehicle Weight Rating): the GVWR is the maximum permitted gross weight of the fully laden vehicle (weight of the vehicle including all accessories, occupants, fuel, luggage and the trailer tongue weight if applicable). The gross vehicle weight rating is specified on the vehicle identification plate on the B-pillar on the driver's side.

Maximum weight of the laden vehicle: the maximum weight is the sum of the unladen weight of the vehicle, the weight of the accessories, the

maximum load and the weight of optional equipment installed at the factory.

Kilopascal (kPa): metric unit for tire pressure. 6.9 kPa corresponds to 1 psi. Another unit for tire pressure is bar. 100 kilopascal (kPa) equals 1 bar.

Load index: in addition to the load-bearing index, the load index may also be imprinted on the side wall of the tire. This specifies the load-bearing capacity of the tire more precisely.

Unladen weight: the weight of a vehicle with standard equipment including the maximum capacity of fuel, service fluids and coolant. It also includes the air conditioning system and optional equipment if these are installed in the vehicle, but does not include passengers or luggage.

Maximum tire load: the maximum tire load is the maximum permissible weight in kilograms or lbs for which a tire is approved.

Maximum permissible tire pressure: maximum permissible tire pressure for one tire.

Maximum load on one tire: maximum load per tire. This is calculated by dividing the maximum axle load of one axle by two.

PSI (pounds per square inch): standard unit of measurement for tire pressure.

Aspect ratio: ratio between tire height and tire width in percent.

Tire pressure: pressure inside the tire applying an outward force to every square inch of the tire. The tire pressure is specified in pounds per square inch (psi), in kilopascals (kPa) or in bar. The tire pressure should only be corrected when the tires are cold.

Cold tire pressure: the tires are cold when the vehicle has been parked for at least 3 hours without direct sunlight on the tires, or the vehicle has been driven for less than 1 mile (1.6 km).

Tire contact surface: the part of the tire that comes into contact with the road.

Tire bead: the purpose of the tire bead is to ensure that the tire sits securely on the wheel rim. There are several wire cores in the tire bead to prevent the tire from changing length on the wheel rim.

Side wall: the part of the tire between the tread and the tire bead.

Weight of optional equipment: the combined weight of the optional equipment weighing more than the replaced standard parts and more than 5 lbs (2.3 kg). This optional equipment, such as high-performance brakes, level control system, a roof luggage rack or high-performance batteries, is not included in the unladen weight and the weight of the accessories.

TIN (Tire Identification Number): a unique identification number which can be used by a tire manufacturer to identify tires, for example in a product recall, and thus identify the purchasers. The TIN is made up of the manufacturer's identity code, tire size, tire type code and the manufacturing date.

Load-bearing index: the load-bearing index is a code that contains the maximum load-bearing capacity of a tire.

Traction: traction is the grip resulting from friction between the tire and the road surface.

Wear indicator: narrow bars (tread wear bars) that are distributed over the tire contact surface. If the tire tread is level with the bars, the wear limit of 1/16 in (1.6 mm) has been reached.

Distribution of vehicle occupants: distribution of vehicle occupants over designated seat positions in a vehicle.

Maximum permissible payload weight: nominal load and luggage load plus 150 lb (68 kg) multiplied by the number of seats in the vehicle.

Changing a wheel

Notes on selecting, installing and replacing tires

! **NOTE** Mercedes-AMG vehicles

▶ Observe the notes in the Supplement. You could otherwise fail to recognize dangers.

⚠ **WARNING** Risk of accident due to incorrect wheel and tire dimensions

If wheels and tires of the wrong size are installed, the service brakes or components in the brake system and in the wheel suspension may be damaged.

▶ Always replace wheels and tires with ones that fulfill the specifications of the original part.

For wheels, pay attention to the following:

- Designation
- Type

For tires, pay attention to the following:

- Designation
- Manufacturer
- Type

⚠ **WARNING** Risk of injury through exceeding the specified tire load-bearing capacity or the permissible speed rating

Exceeding the specified tire load rating or the permissible speed rating may lead to tire damage and to the tires bursting.

- ▶ Therefore, only use tire types and sizes approved for your vehicle model.
- ▶ Observe the tire load rating and speed rating required for your vehicle.

! **NOTE** Vehicle and tire damage caused by non-approved tire types and sizes

For safety reasons, only use tires, wheels and accessories which have been specially approved by Mercedes-Benz for your vehicle.

These tires are specially adapted to the active safety systems, such as ABS, ESP® and 4MATIC, and marked as follows:

- MO = Mercedes-Benz Original
- MOE = Mercedes-Benz Original Extended (tires with run-flat characteristics for certain wheels only)
- MO1 = Mercedes-Benz Original (only certain AMG tires)

Otherwise, certain properties, such as driving characteristics, vehicle noise emissions, consumption, etc. could be adversely affected. Furthermore, other tire sizes could result in the tires rubbing against the body and axle components when loaded. This could result in damage to the tire or the vehicle.

Only use tires, wheels and accessories that have been checked and recommended by Mercedes-Benz.

! **NOTE** Risk to driving safety from retreaded tires

Retreaded tires are neither tested nor recommended by Mercedes-Benz, since previous damage cannot always be detected on retreaded tires.

For this reason driving safety cannot be guaranteed.

- ▶ Do not use used tires if you have no information about their previous usage.

! **NOTE** Possible wheel and tire damage when driving over obstacles

Large wheels have a smaller section width. As the section width decreases, the risk of wheels and tires being damaged when driving over obstacles increases.

- ▶ Avoid obstacles or drive especially carefully.
- ▶ Reduce your speed when driving over curbs, speed bumps, manhole covers and potholes.
- ▶ Avoid particularly high curbs.

! **NOTE** Possible wheel and tire damage when parking on curbs or in potholes

Parking on curbs or in potholes can damage the wheels and tires.

- ▶ Only park on as level a surface as possible.
- ▶ Avoid curbs and potholes when parking.

! **NOTE** Damage to electronic components due to the use of mounting tools

Vehicles with a tire pressure monitoring system: there are electronic components in the wheel.

Using mounting tools in the area of the valve may damage the electronic components.

- ▶ Tire mounting tools should not be used in the area of the valve.
- ▶ Always have tires changed at a qualified specialist workshop.

! **NOTE** Damage to summer tires at low ambient temperatures

At low ambient temperatures, tears could form when driving with summer tires, causing permanent damage to the tires.

- ▶ At temperatures below 45 °F (7 °C) use  M+S tires.

Accessory parts which are not approved for your vehicle by Mercedes-Benz, or which are not used correctly, can impair the operating safety.

Before purchasing and using non-approved accessories, visit a qualified specialist workshop and inquire about:

- Suitability
- Legal stipulations
- Factory recommendations

⚠ WARNING Risk of accidents with sports tires

The special tire tread in combination with the optimized tire compound means that the risk of skidding or hydroplaning on wet roads is increased.

In addition, the tire grip is greatly reduced at a low outside temperature and tire running temperature.

- ▶ Switch on ESP® and adapt your driving style accordingly.
- ▶ Use  M+S tires at outside temperatures of less than 45 °F (7 °C).
- ▶ Only use tires suitable for the intended use.

Observe the following when selecting, installing and replacing tires:

- The use of certain tire types in certain regions and areas of operation can be advisable.
- Only use tires and wheels of the same type (summer tires, winter tires, MOExtended tires) and the same make.

- Only install wheels of the same size on one axle (left and right).
Only deviate from this in the event of a flat tire, to enable you to drive to a specialist workshop.
- **Vehicles with a tire pressure monitoring system:** all installed wheels must be equipped with functioning sensors for the tire pressure monitoring system.

- At temperatures below 45 °F (7 °C), use winter tires or all-season tire marked  M+S for all wheels.

Winter tires provide the best possible grip in wintry road conditions.

- When fitting M+S tires, only use tires with the same tread.
- Observe the maximum permissible speed for the M+S tires installed.

If the tire's maximum speed is below that of the vehicle, this must be indicated by an appropriate label in the driver's field of vision.

- Run-in new tires at moderate speeds for the first 60 miles (100 km).

- Replace the tires after six years at the latest, regardless of wear.
- **When replacing with tires that do not feature run-flat characteristics:** vehicles with MOExtended tires are not equipped with a TIREFIT kit at the factory. Equip the vehicle with a TIREFIT kit after fitting tires that do not feature run-flat characteristics, e.g. winter tires.

For more information on wheels and tires, contact a qualified specialist workshop.

Be sure to also observe the following further related topics:

- Notes on tire pressure (→ page 322)
- Tire and Loading Information table (→ page 328)
- Tire size, load-bearing capacity, speed rating and load index (→ page 335)
- Tire pressure table (→ page 324)
- Notes on the emergency spare wheel (→ page 349)

Notes on rotating wheels

⚠ WARNING Risk of injury through different wheel sizes

Rotating the front and rear wheels can severely impair the driving characteristics.

The wheel brakes or suspension components may also be damaged.

▶ Rotate front and rear wheels only if the wheels and tires are of the same dimensions.

Observe the instructions and safety notes on "Changing a wheel" (→ page 340).

The front and rear wheels are subject to different wear:

- Front wheels wear more on the tire shoulder
- Rear wheels wear more in the center of the tire

Do not drive with tires that have too little tread depth. This significantly reduces traction on wet roads (hydroplaning).

On vehicles that have the same size front and rear wheels, rotate the wheels according to the intervals in the tire manufacturer's warranty booklet in your vehicle documents. If this is not available, rotate the tires every 3,000 to 6,000 miles (5,000 to 10,000 km), depending on wear. Do not change the direction of wheel rotation.

Notes on storing wheels

When storing wheels, observe the following notes:

- After removing wheels, store them in a cool, dry and preferably dark place.
- Protect the tires from contact with oil, grease or fuel.

Overview of the tire-change tool kit

⚠ NOTE Mercedes-AMG vehicles

▶ Observe the notes in the Supplement. You could otherwise fail to recognize dangers.

With the exception of some country-specific variants, vehicles are not equipped with a tire-change tool kit. Consult a qualified specialist workshop to find out which tire-change tool kit is necessary and approved for a wheel change on your vehicle.

You require the following tools, foreexample, to change a wheel:

- Jack
- Chock
- Lug wrench
- Alignment bolt

The tire-change tool kit is located in the tool bag **1** in the trunk.

- i** Depending on the respective vehicle model, the tool bag may be located in other positions in the trunk.
- i** When stowing the tool bag, ensure that it is adequately secured.

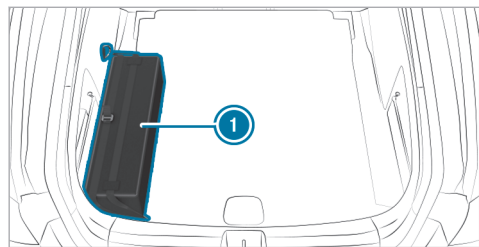

The tool bag contains:

- Jack
- Gloves
- Lug wrench
- Alignment bolt
- Folding chock
- Ratchet wrench for jack

Preparing the vehicle for a wheel change

Requirements

- The vehicle is not on a slope.

- The vehicle is on solid, non-slippery and level ground.
- The required wheel changing tools are on board.

i If your vehicle is not equipped with wheel changing tools, consult a qualified specialist workshop to find out about suitable tools.

- ▶ Apply the electric parking brake manually.
- ▶ Move the front wheels to the straight-ahead position.
- ▶ Shift the transmission to position **P**.
- ▶ Switch off the vehicle.
- ▶ Make sure that the vehicle cannot be started.
- ▶ Place chocks or other suitable items under the wheel that is diagonally opposite the wheel you wish to change.
- ▶ If necessary, remove the hub cap/hub cover (→ page 344).
- ▶ Raise the vehicle (→ page 345).

Removing and installing wheel trim/hub caps

Requirements

- The vehicle is prepared for a wheel change (→ page 344).

Plastic hub cap

Removing:

- ▶ Turn the center cover of the hub cap counter-clockwise and remove the hub cap.

Installing:

- ▶ Make sure that the center cover of the hub cap has been turned counter-clockwise.
- ▶ Position the hub cap and turn the center cover clockwise until the hub cap is felt and heard to engage.

Aluminum hub cap

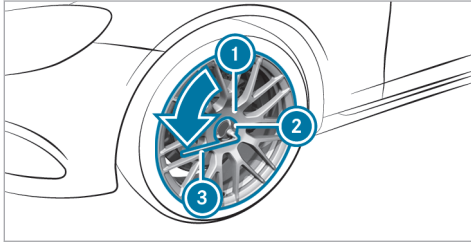

Removing:

- ▶ Position socket ② from the tire-change tool kit on hub cap ①.
- ▶ Position wheel wrench ③ on socket ②.
- ▶ Using wheel wrench ③ to turn the hub cap ① counter-clockwise and remove it.

Installing:

- ▶ Follow the instructions above in reverse order.
- ⓘ **Specified tightening torque:** 18 lb-ft (25 Nm).

Raising the vehicle when changing a wheel

Requirements

- There are no persons in the vehicle.
- The vehicle has been prepared for a wheel change (→ page 344).

Important notes on using the jack:

- Use only a vehicle-specific jack that has been approved by Mercedes-Benz to raise the vehicle.
- The jack is only designed for raising and holding the vehicle for a short time while a wheel is being changed and not for maintenance work under the vehicle.
- The jack must be placed on a firm, flat and non-slip surface. If necessary, use a large, flat, load-bearing, non-slip underlay.
- The foot of the jack must be positioned vertically under the jack support point.

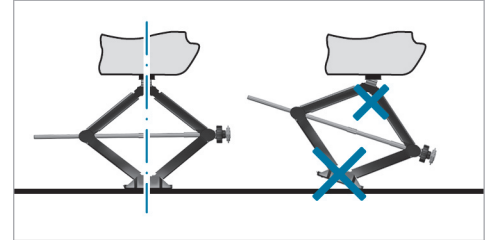

Rules of conduct when the vehicle is raised:

- Do not put your hands or feet under the vehicle.
- Do not lie under the vehicle.
- Do not start the vehicle and do not release the electric parking brake.
- Do not open or close any doors or the trunk lid.

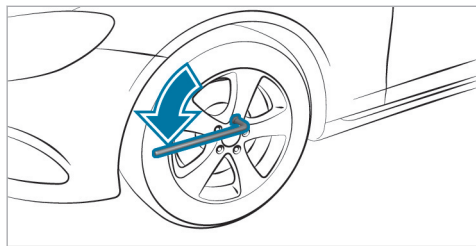

▶ Using the wheel wrench, loosen the wheel bolts on the wheel you wish to change by about one full turn. Do not unscrew the screws completely.

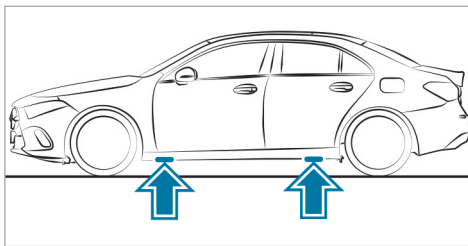

Position of the jack support points

! **NOTE** Mercedes-AMG vehicles

▶ Observe the notes in the Supplement. You could otherwise fail to recognize dangers.

! **WARNING** Risk of injury from incorrect positioning of the jack

If you do not position the jack correctly at the appropriate jacking point of the vehicle, the jack could tip with the vehicle raised.

▶ Only position the jack at the appropriate jacking point of the vehicle. The base of

the jack must be positioned vertically under the jacking point of the vehicle.

! **NOTE** Damage to the vehicle due to the jack

If you do not position the jack at the jack support points provided for this purpose, you could damage your vehicle.

▶ Only position the jack at the jack support points provided for this purpose.

▶ Take the ratchet out of the tire-change tool kit and place it on the hexagon nut of the jack so that the letters "AUF" are visible.

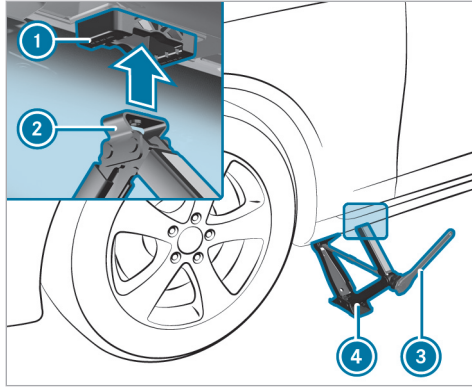

▶ Position support ② of jack ④ on jack support point ①.

ⓘ If there is a total loss of pressure in a tire, it may be possible that the jack cannot be positioned at jack support point ①. In this case, unload the vehicle.

- ▶ Turn ratchet ③ clockwise until support ② sits completely on jack support point ① and the base of the jack lies evenly on the ground.
- ▶ Turn ratchet ③ until the tire is raised a maximum of 1.2 in (3 cm) from the ground.
- ▶ Loosen and remove the wheel (→ page 347).

Removing a wheel

Requirements

- The vehicle is raised (→ page 345).

⚠ **NOTE** Mercedes-AMG vehicles

- ▶ Observe the notes in the Supplement. You could otherwise fail to recognize dangers.

When changing a wheel, avoid applying any force to the brake discs, since this could impair the level of comfort when braking.

⚠ **NOTE** Damage to threading from dirt on wheel bolts

- ▶ Do not place wheel bolts in sand or on a dirty surface.

- ▶ Unscrew the uppermost wheel bolt completely.

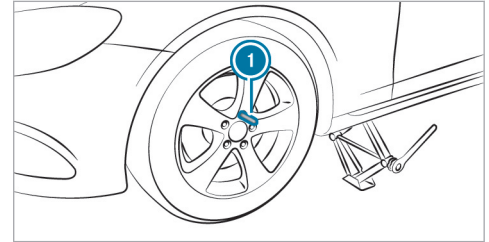

- ▶ Screw centering pin ① into the thread instead of the wheel bolt.
- ▶ Unscrew the remaining wheel bolts completely.
- ▶ Remove the wheel.

Mounting a new wheel

Requirements

- The wheel to be changed is removed and the centering pin is screwed in (→ page 347).

! NOTE Mercedes-AMG vehicles

- ▶ Observe the notes in the Supplement. You could otherwise fail to recognize dangers.

! WARNING Risk of accident from losing a wheel

Oiled, greased or damaged wheel bolt/wheel nut threads or wheel hub/wheel mounting bolt threads can cause the wheel bolts/wheel nuts to come loose.

- ▶ Never oil or grease the threads.
- ▶ In the event of damage to the threads, contact a qualified specialist workshop immediately.
- ▶ Have the damaged wheel bolts or damaged hub threads replaced.

- ▶ Do not continue driving.

- ▶ Observe the information on the choice of tires (→ page 340).

For tires with a specified direction of rotation, an arrow on the side wall of the tire indicates the correct direction of rotation. Observe the direction of rotation when mounting.

- ▶ Slide the wheel to be mounted onto the centering pin and push it on.

! WARNING Risk of injury from tightening wheel bolts and nuts

If you tighten the wheel bolts or wheel nuts when the vehicle is raised, the jack could tip.

- ▶ Only tighten wheel bolts or wheel nuts when the vehicle is on the ground.

- ▶ Be sure to observe the instructions and safety notes on "Changing a wheel" (→ page 340).

- ▶ For safety reasons, only use wheel bolts which have been approved by Mercedes-Benz and for the wheel in question.

! NOTE Damage to paintwork of the wheel rim when screwing in the first wheel bolt

If the wheel has too much play when screwing in the first wheel bolt, the wheel rim paint can be damaged.

- ▶ Press the wheel firmly against the wheel hub when screwing in the first wheel bolt.

- ▶ Tighten the wheel bolts evenly in a diagonal pattern in the order indicated until they are finger-tight.
- ▶ Unscrew and remove the centering pin.
- ▶ Tighten the last wheel bolt until it is finger-tight.
- ▶ Lower the vehicle (→ page 349).

Lowering the vehicle after a wheel change

Requirements:

- The new wheel has been installed (→ page 348).

- ▶ **To lower the vehicle:** place the ratchet wrench onto the hexagon nut of the jack so that the lettering "AB" are visible and turn counter-clockwise.

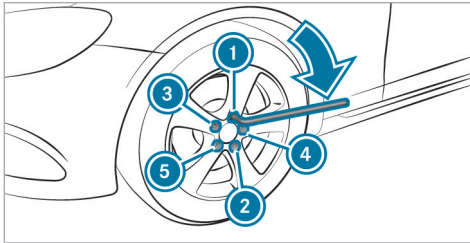

- ▶ Tighten the wheel bolts evenly in a diagonal pattern in the indicated order ① to ⑤ with an initial maximum force of 59 lb-ft (80 Nm).
- ▶ Tighten the wheel bolts evenly in a diagonal pattern in the indicated order ① to ⑤ with

the specified tightening torque of 96 lb-ft (130 Nm).

⚠ WARNING Risk of accident due to incorrect tightening torque

The wheels could come loose if the wheel bolts or wheel nuts are not tightened to the prescribed torque.

- ▶ Ensure that the wheel bolts or wheel nuts are tightened to the prescribed tightening torque.
- ▶ If you are not sure, do not move the vehicle. Contact a qualified specialist workshop and have the tightening torque checked immediately.

- ▶ Check the tire pressure of the newly installed wheel and adjust it if necessary.

ⓘ The following does not apply if the new wheel is an emergency spare wheel:

- ▶ **Vehicles with tire pressure monitoring system:** restart the tire pressure monitoring system (→ page 327).

Emergency spare wheel

Notes on the emergency spare wheel

⚠ WARNING Risk of accident caused by incorrect wheel and tire dimensions

The wheel or tire sizes and the tire type of the emergency spare wheel or spare wheel and the wheel to be replaced may differ. The emergency spare wheel or spare wheel can significantly impair driving characteristics of the vehicle.

To prevent hazardous situations:

- ▶ Drive carefully.
- ▶ Never install more than one emergency spare wheel or spare wheel that differs in size.
- ▶ Only use an emergency spare wheel or spare wheel briefly.
- ▶ Do not deactivate ESP®.
- ▶ Have the emergency spare wheel or spare wheel of a different size replaced at the nearest qualified specialist work-

shop. The new wheel must have the correct dimensions.

- ① The emergency spare wheel is secured in the emergency spare wheel bag in the trunk.

Observe the following notes on installing an emergency spare wheel:

- The maximum permissible speed with an emergency spare wheel installed is 50 mph (80 km/h).
 - Do not install the emergency spare wheel with snow chains.
 - Replace the emergency spare wheel after six years at the latest, regardless of wear.
 - Use the included wheel bolts for the emergency spare wheel.
 - Check the tire pressure of the emergency spare wheel when installed. Correct the pressure as necessary.
- ① The specified tire pressure is stated on the label of the emergency spare wheel.

- ① **Vehicles with tire pressure monitoring system:** if an emergency spare wheel is installed, the tire pressure monitoring system cannot function reliably. For a few minutes after an emergency spare wheel is installed, the system may still display the tire pressure of the removed wheel. Only restart the system when the emergency spare wheel has been replaced with a new wheel.

Be sure to observe the following further related topics:

- Notes on tire pressure (→ page 322)
- Tire and load information placard (→ page 328)
- Tire pressure table (→ page 324)
- Notes on installing tires (→ page 340)
- Installing an emergency spare wheel (→ page 344)

Inflating the emergency spare wheel

! **NOTE** Overheating due to the tire inflation compressor running too long

▶ Do not run the tire inflation compressor for longer than ten minutes without interruption.

Requirements:

Comply with the manufacturer's safety notes on the sticker of the emergency spare wheel and on the tire inflation compressor.

- ▶ Remove the sticker with the label 50 mph (80 km/h) from the tire inflation compressor housing and affix it to the instrument cluster within the driver's field of vision.
- ▶ Remove the tire inflation compressor from the storage well under the trunk floor (→ page 302).

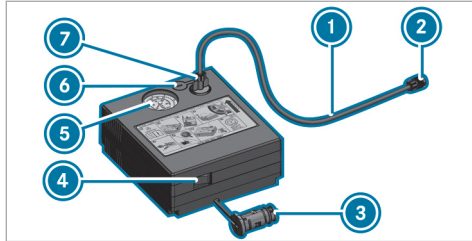

- ▶ Pull filler hose ① and plug ③ out of the tire inflation compressor housing.
- ▶ Insert plug ⑦ of filler hose ① in the socket on the tire inflation compressor and then turn it until plug ⑦ engages.
- ▶ Unscrew the cap from the valve on the emergency spare wheel.
- ▶ Screw union nut ② of filler hose ① onto valve.
- ▶ Make sure on and off switch ④ of the tire inflation compressor is set to 0.
- ▶ Insert plug ③ in a socket in your vehicle.
- 12 V socket (→ page 120)

- Observe the notes on sockets (→ page 120).
- ▶ Press the start/stop button once to switch on the power supply (→ page 141).
- ▶ Press on and off switch ④ on the tire inflation compressor to 1.
The tire inflation compressor is switched on. The tire is inflated. The tire pressure is shown on manometer ⑤.
- ▶ Pump the tire to the specified tire pressure.
- ① The specified tire pressure is stated on the label of the emergency spare wheel.
- ▶ When the specified tire pressure has been reached, press on and off switch ④ on the tire inflation compressor to 0.
The tire inflation compressor is switched off.
- ▶ Press the start/stop button to switch off the power supply.
- ▶ If the tire pressure is higher than the specified pressure, press pressure release valve button ⑥ until the correct tire pressure has been reached.

- ▶ Unscrew union nut ② of filler hose ① from the valve.
- ▶ Screw the valve cap of the emergency spare wheel onto the valve again.
- ▶ Store filler hose ① and plug ③ in the lower section of the tire inflation compressor housing.
- ▶ Store the tire inflation compressor in the vehicle.

Notes on technical data

! NOTE Mercedes-AMG vehicles

- ▶ Observe the notes in the Supplement. You could otherwise fail to recognize dangers.

The data stated only applies to vehicles with standard equipment. You can obtain further information from an authorized Mercedes-Benz Center.

Vehicle electronics

Two-way radios

! Notes on installing two-way radios

! WARNING Risk of accident due to improper work on two-way radios

If two-way radios are manipulated or retrofitted incorrectly, the electromagnetic radiation from the two-way radios can interfere with the

vehicle electronics and jeopardize the operating safety of the vehicle.

- ▶ You should have all work on electrical and electronic components carried out at a qualified specialist workshop.

! WARNING Risk of accident due to improper operation of two-way radios

If you use two-way radios in the vehicle improperly, their electromagnetic radiation can disrupt the vehicle's electronics. This is the case in the following situations, in particular:

- The two-way radio is not connected to an exterior antenna.
- The exterior antenna is installed incorrectly or is not a low-reflection antenna.

This could jeopardize the operating safety of the vehicle.

- ▶ Have the low-reflection exterior antenna installed at a qualified specialist workshop.

- ▶ When operating two-way radios in the vehicle, always connect them to the low-reflection exterior antenna.

! NOTE Invalidation of the operating permit due to failure to comply with the instructions for installation and use

The operating permit may be invalidated if the instructions for installation and use of two-way radios are not observed.

- ▶ Only use approved frequency bands.
- ▶ Observe the maximum permissible output power in these frequency bands.
- ▶ Only use approved antenna positions.

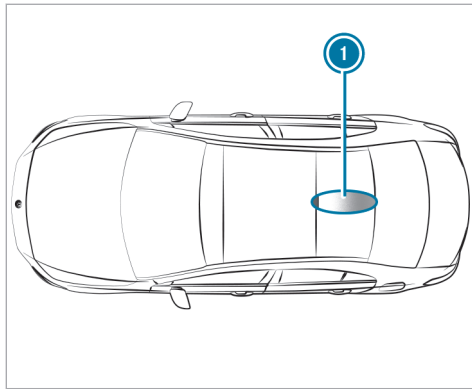

1 Rear roof area

Installing a roof antenna on a vehicle with a panorama roof with power tilt/sliding panel is not permitted.

Use Technical Specification ISO/TS 21609 (Road Vehicles – "EMCs for installation of aftermarket radio frequency transmitting equipment") when

retrofitting two-way radios. Comply with the legal requirements for detachable parts.

If your vehicle is equipped with the pre-installation for a two-way radio, use the power supply and antenna connectors provided in the pre-installation. Observe the manufacturer's supplements when installing.

Mobile phone transmission output

The maximum transmission output (PEAK) at the base of the antenna must not exceed the values in the following table.

Frequency band and maximum transmission output

Frequency band	Maximum transmission output
2-m- frequency band 144 - 174 MHz	50 W
Terrestrial Trunked Radio (TETRA) 380 - 460 MHz	10 W

Frequency band	Maximum transmission output
Mobile phone 2G	2 W
Mobile phone 3G/4G/5G	0.5 W

The following can be used in the vehicle without restrictions:

- two-way radios with a maximum transmission output of up to 100 mW
- two-way radios with transmitter frequencies in the 380 -410 MHz frequency band and a maximum transmission output of up to 2 W (TETRA)
- mobile phones (2G/3G/4G/5G)

There are no restrictions regarding the positioning of the antenna on the outside of the vehicle for the following frequency bands:

- Terrestrial Trunked Radio (TETRA)
- 2G/3G/4G/5G

Radio regulations

Regulatory radio identifiers and specific notes

Manufacturer information about radio-based vehicle components can be found using the key phrase "Regulatory radio information" in the Digital Operator's Manual in the vehicle, on the internet and in the app.

Further information and updates are available at the following web address:

[https://
regulatoryradioinformation.corpinter.net/us](https://regulatoryradioinformation.corpinter.net/us)



Information about the specific absorption rate (SAR)

Information on the specific absorption rate (SAR) can be found under the key word "Regulatory

information" in the vehicle's Digital Operator's Manual, on the Internet and in the app.

Further information and updates are available at the following web address:

[https://
regulatoryradioinformation.corpinter.net/us](https://regulatoryradioinformation.corpinter.net/us)



Vehicle identification plate, VIN and engine number overview

Vehicle identification plate

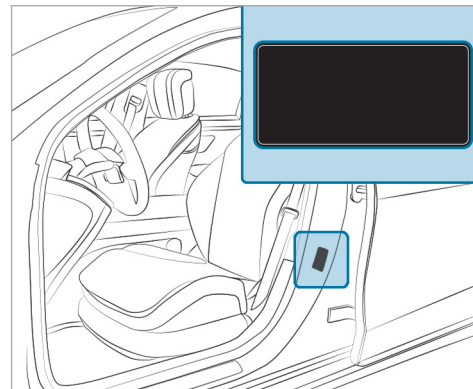

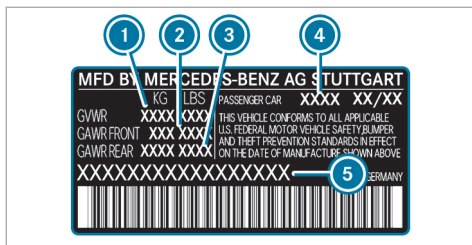

Vehicle identification plate (USA only)

- ① Gross vehicle weight rating
- ② Gross axle weight rating for front axle
- ③ Gross axle weight rating for rear axle
- ④ Paint code
- ⑤ VIN (vehicle identification number)

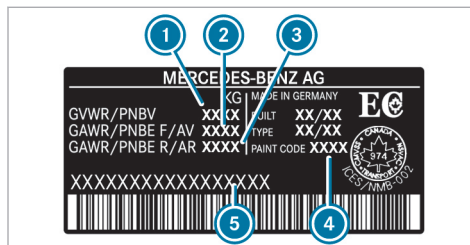

Vehicle identification plate (Canada only)

- ① Gross vehicle weight rating
- ② Gross axle weight rating for front axle
- ③ Gross axle weight rating for rear axle
- ④ Paint code
- ⑤ VIN (vehicle identification number)

The gross vehicle weight rating is made up of the vehicle weight, all vehicle occupants, the fuel and the load. The gross axle weight rating is the maximum weight that can be carried on one axle (front or rear axle).

Do not exceed the gross vehicle weight rating or the gross axle weight rating for the front or rear axle.

VIN, engine number and other signs

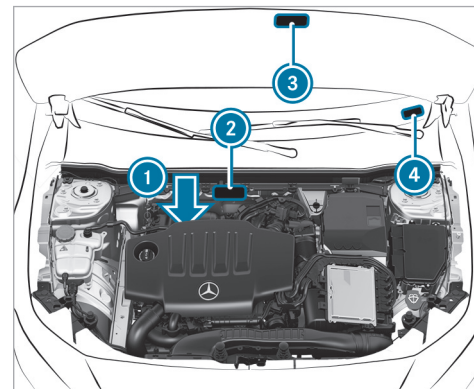

- ① Engine number stamped into the crankcase
- ② VIN (vehicle identification number) stamped onto the crossmember

- ③ Plate with information about emissions testing, including confirmation of emissions guidelines at the U.S. federal level as well as for California
- ④ VIN as a label at the lower edge of the windshield

Operating fluids

Notes on operating fluids

! NOTE Mercedes-AMG vehicles

- ▶ Observe the notes in the Supplement. You could otherwise fail to recognize dangers.

⚠ WARNING Risk of injury due to harmful operating fluids

Operating fluids can be toxic.

- ▶ When using, storing and disposing of operating fluids, observe the imprints on the respective original containers.

- ▶ Always keep operating fluids in the sealed original container.
- ▶ Always keep children away from operating fluids.



ENVIRONMENTAL NOTE Pollution of the environment due to irresponsible disposal of operating fluids

Incorrect disposal of operating fluids can cause considerable damage to the environment.

- ▶ Dispose of operating fluids in an environmentally responsible manner.

Operating fluids include the following:

- Fuels
- Lubricants
- Coolant
- Brake fluid
- Windshield washer fluid
- Climate control system refrigerant

Only use products approved by Mercedes-Benz. Damage caused by the use of products that have not been approved is not covered by the Mercedes-Benz warranty or goodwill gestures.

The operating fluids approved by Mercedes-Benz can be identified by the following inscriptions on the container:

- MB-Freigabe (e.g. MB-Freigabe 229.51)
- MB-Approval (e.g. MB-Approval 229.51)

Further information on approved operating fluids:

- in the Mercedes-Benz Specifications for Operating Fluids by entering the designation
 - At <https://operatingfluids.mercedes-benz.com>
- At a qualified specialist workshop

⚠ WARNING Risk of fire or explosion from fuel

Fuels are highly flammable.

- ▶ Fire, open flames, smoking and creating sparks must be avoided.

- ▶ Before and during refueling, switch off the vehicle and, if installed, the stationary heater.

⚠ WARNING Risk of injury from fuels

Fuels are poisonous and hazardous to your health.

- ▶ Do not swallow fuel or let it come into contact with skin, eyes or clothing.
- ▶ Do not inhale fuel vapor.
- ▶ Keep children away from fuel.
- ▶ Keep doors and windows closed during the refueling process.

If you or other people come into contact with fuel, observe the following:

- ▶ Immediately rinse fuel off your skin with soap and water.
- ▶ If fuel comes into contact with your eyes, immediately rinse them thoroughly with clean water. Seek medical attention immediately.

- ▶ If you swallow fuel, seek medical attention immediately. Do not induce vomiting.
- ▶ Change immediately out of clothing that has come into contact with fuel.

Flexible-fuel vehicles can be refueled with the following fuel types:

- premium-grade unleaded gasoline
- E85 fuel
- a mixture of E85 fuel and premium-grade unleaded gasoline

Flexible-fuel vehicles can be identified by the **Ethanol up to E85** sticker on the inside of the fuel filler flap.

Depending on the country, the fuels you can use in your vehicle may differ from the information in the Operator's Manual. The fuels that have been approved for your vehicle can be found on the instruction label on the inside of the fuel filler flap.

Fuel

■ Information on fuel quality for vehicles with gasoline engine

Observe the notes on operating fluids (→ page 356).

! NOTE Damage caused by the wrong fuel

Even small amounts of the wrong fuel could result in damage to the fuel system, the engine and the emission control system.

- ▶ Refuel only with low-sulfur spark-ignition engine fuel.

This fuel may contain up to 10% ethanol by volume. Your vehicle is suitable for use with E10 fuel.

Never refuel with any of the following fuels:

- Diesel
- gasoline with more than 10% Ethanol, z.B. E15, E85, E100

- gasoline with more than 3% methanol by volume, e.g. M15, M30, M85, M100
- gasoline with metallic additives

If you have accidentally refueled with the wrong fuel:

- ▶ Do not switch on the vehicle.
- ▶ Consult a qualified specialist workshop.

If the available fuel is not sufficiently low in sulfur, it may produce unpleasant odors.

Only refuel with fuel that has at least the octane rating specified in the information label on the fuel filler flap. Otherwise engine output may be reduced and fuel consumption increased.

For maximum engine output: refuel only with premium unleaded gasoline with an octane rating of at least 91 AKI/95 RON.

If the recommended fuel is not available, you may also temporarily use regular unleaded gasoline with an octane rating of at least 87 AKI/91 RON. This may reduce engine output and increase fuel consumption.

Never refuel using gasoline with an even lower RON.

! **NOTE** Premature engine wear through unleaded regular gasoline

Impairment of the longevity and performance of the engine.

If unleaded premium grade gasoline is unavailable and you have to refuel using unleaded regular gasoline:

- ▶ Only fill the fuel tank to half full with unleaded regular gasoline and refill as soon as possible with unleaded premium grade gasoline.
- ▶ Do not drive at the maximum design speed.
- ▶ Avoid sudden acceleration and engine speeds over 3000 rpm.

Further information on fuel is available in the following locations:

- At a gas station
- At a qualified specialist workshop

- **USA only:** on the <https://www.mbusa.com>

Information on additives in gasoline (vehicles with gasoline engine)

Observe the notes on operating fluids (→ page 356).

! **NOTE** Damage from use of unsuitable additives

Even small amounts of the wrong additive may lead to malfunctions occurring.

- ▶ Only add cleaning additives recommended by Mercedes-Benz to the fuel.

Mercedes-Benz recommends that you use brand-name fuels with additives.

In some countries, the fuel available may not have sufficient additives. Deposits could build up in the fuel injection system as a result. In this case, in consultation with a qualified specialist workshop (e.g. an authorized Mercedes-Benz Service Center), mix the fuel with the cleaning additive recommended by Mercedes-Benz. Observe the notes and mixing ratios indicated on the tank.

■ Tank capacity and fuel reserve

Total fuel tank capacity

Model	
All models	13.5 gal (51.0 liters)

Fuel tank reserve

Model	
All models	1.3 gal (5.0 liters)

Engine oil

■ Notes on engine oil

Observe the notes on operating fluids (→ page 356).



! **NOTE** Engine damage caused by an incorrect oil filter, incorrect oil or additives

- ▶ Do not use engine oils or oil filters other than those which meet the specifications necessary for the prescribed service intervals.
- ▶ Do not alter the engine oil or oil filter in order to achieve longer change intervals than prescribed.
- ▶ Do not use additives.
- ▶ Have the engine oil changed after the prescribed intervals.

Mercedes-Benz recommends having the oil changed at a qualified specialist workshop.

Only use engine oils approved for your vehicle by Mercedes-Benz.

■ Engine oil quality and filling quantity

Engine oil specification

Model	MB-Freigabe or MB-Approval
All models	229.71, 229.72*

* Recommended for the lowest possible fuel consumption (lowest SAE viscosity class in each case; observe possible restrictions of the approved SAE viscosity classes).

i If the engine oils listed in the table are not available, adding a maximum of 1.1 US qt (1.0 l) of the following engine oils is permissible once:

Vehicles with gasoline engine:

- **CLA 180, CLA 200:** MB-Freigabe or MB-Approval 229.51, 229.52 or ACEA C5

- **All other models:** MB-Freigabe or MB-Approval 229.51, 229.52, 229.61 or ACEA C5

Engine oil filling quantity

Model	Quantity
All models	5.3 US qt (5.0 liters)

The specified filling quantity refers to an oil change with replacement of the oil filter.

Notes on brake fluid

Please observe the notes on operating fluids (→ page 356).

⚠ WARNING Risk of an accident due to vapor pockets forming in the brake system

The brake fluid constantly absorbs moisture from the air. This lowers the boiling point of the brake fluid. If the boiling point is too low, vapor pockets may form in the brake system when the brakes are applied hard.

This causes the braking effect to be impaired.

▶ Have the brake fluid renewed at the specified intervals.

Have the brake fluid regularly replaced at a qualified specialist workshop.

Only use a brake fluid according to MB-Freigabe or MB-Approval 331.0 approved by Mercedes-Benz.

Coolant

Notes on coolant

Observe the notes on operating fluids (→ page 356).

⚠ WARNING - Risk of fire and injury from antifreeze

If antifreeze comes into contact with hot component parts in the engine compartment, it may ignite.

▶ Allow the engine to cool down before adding antifreeze.

▶ Make sure that no antifreeze spills out next to the filler opening.

▶ Thoroughly clean off any antifreeze from component parts before starting the vehicle.

! **NOTE** Damage caused by incorrect coolant

▶ Only use coolant that has been premixed with the required antifreeze protection.

Information on coolant is available at the following locations:

- In the Mercedes-Benz Specification for Operating Fluids 320.1
 - At <https://operatingfluids.mercedes-benz.com>
- At a qualified specialist workshop

! **NOTE** Overheating at high outside temperatures

If an inappropriate coolant is used, the cooling system is not sufficiently protected against overheating and corrosion at high outside temperatures.

- ▶ Only use coolant approved for Mercedes-Benz.
- ▶ Observe the instructions in the Mercedes-Benz Specifications for Operating Fluids 320.1.

Have the coolant regularly replaced at a qualified specialist workshop.

Proportion of antifreeze concentrate in the cooling system:

- A minimum of 50% (antifreeze protection down to about -35°F (-37°C))
- A maximum of 55% (antifreeze protection down to -49°F (-45°C))

■ Coolant filling quantity

Coolant (engine)

Model	Quantity
All models	9.4 US qt (8.9 liters)

Notes on windshield washer fluid

Observe the notes on operating fluids (→ page 356).

! **WARNING** - Risk of fire and injury from windshield washer concentrate

Windshield washer concentrate is highly flammable. It could ignite if it comes into contact with hot engine component parts or the exhaust system.

- ▶ Make sure that no windshield washer concentrate spills out next to the filler opening.

! **NOTE** Damage to the exterior lighting due to unsuitable windshield washer fluid

Unsuitable windshield washer fluid may damage the plastic surface of the exterior lighting.

- ▶ Only use windshield washer fluid which is also suitable for use on plastic surfaces, e.g. MB SummerFit or MB WinterFit.

! **NOTE** Blocked spray nozzles caused by mixing windshield washer fluids

- ▶ Do not mix MB SummerFit and MB WinterFit with other windshield washer fluids.

Do not use distilled or de-ionised water. Otherwise, the fill level sensor may be triggered erroneously.

Recommended windshield washer fluid:

- Above freezing point: e.g. MB SummerFit
- Below freezing point: e.g. MB WinterFit

For the correct mixing ratio, refer to the information on the antifreeze container.

Mix washing water with windshield washer fluid all year round.

Refrigerant

Notes on refrigerant

Observe the notes on operating fluids (→ page 356).

! NOTE Damage due to incorrect refrigerant

If a non-approved refrigerant is used, the climate control system may be damaged.

▶ Use only R-1234yf refrigerant.

! NOTE Damage to the climate control system due to incorrect refrigerant compressor oil

▶ Only use refrigerant compressor oil that has been approved by Mercedes-Benz.

▶ Do not mix the approved refrigerant compressor oil with a different refrigerant compressor oil.

Work on the climate control system may be carried out only at a qualified specialist workshop. All applicable regulations, as well as SAE standard J639, must be adhered to.

The information label on the climate control system for the refrigerant type and the refrigerant compressor oil (PAG oil) is located on the inside of the hood.

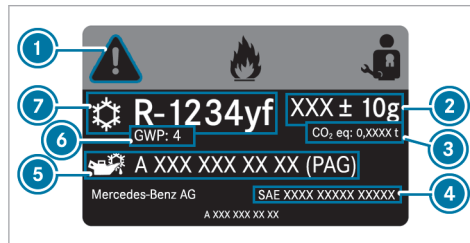

Information label

- ① Hazard and service warning symbols
- ② Refrigerant filling capacity
- ③ CO₂ equivalent of the refrigerant used
- ④ Applicable standards

- ⑤ PAG oil part number
- ⑥ GWP (global warming potential) of the refrigerant used
- ⑦ Refrigerant type

Symbols ① indicate the following:

- Possible dangers
- Maintenance work to be carried out at a qualified specialist workshop

Filling quantity for refrigerant and PAG oil

Refrigerant filling quantity

Model	
All models	18.7 ± 0.4 oz (530 ± 10 g)

Filling quantity for PAG oil

Model	
All models	2.8 ± 0.4 oz (80 ± 10 g)

Vehicle data

Vehicle dimensions

The heights specified may vary as a result of the following factors:

- Tires
- Load
- Condition of the suspension
- Special equipment

Vehicle dimensions

All models	
Vehicle length	186.1 in (4728 mm)
Vehicle width including exterior mirrors	78.7 in (1999 mm)
Vehicle height	57.0 in (1447 mm)
Wheelbase	107.4 in (2729 mm)
Turning radius	36.4 ft (11.1 m)

Weights and loads

Bear in mind that items of special equipment will increase the curb weight and reduce the payload. Vehicle-specific weight information can be found on the vehicle identification plate.

Display messages

Introduction



Information about display messages



Display messages appear on the driver display.

Display messages with graphical symbols are simplified in the Operator's Manual and may differ from the symbols on the driver display. The driver display shows high-priority display messages in red. Certain display messages will be accompanied by a warning tone.

Please act in accordance with the display messages and follow the additional notes in the Operator's Manual.

For some display messages, symbols will also be shown:

-  Further information
-  Hide display message

You can select the respective symbol by swiping left or right on the left-hand Touch Control. Press  to display further information on the central display. Press  to hide the display message.

You can hide display messages to be acknowledged by pressing the back button  or with the left-hand Touch Control. The display messages will then be stored in the message memory.

Rectify the cause of a display message as quickly as possible.

High-priority display messages cannot be hidden. The driver display will show these display messages continuously until the cause of the display message has been rectified.

Calling up saved display messages

Driver display:



 Service

The **Message Memory: XX**message appears on the driver display.

▶ Scroll through the display messages by swiping upwards or downwards on the left-hand Touch Control.

▶ **To exit the display:** press the  back button.

Occupant safety



Display messages	Possible causes/consequences and ► Solutions
 <p data-bbox="194 383 471 440">Restraint System Malfunction Service Required</p>	<p data-bbox="526 295 1053 321">* The restraint system is malfunctioning (→ page 44).</p> <div data-bbox="545 336 1690 450" style="border: 1px solid gray; padding: 5px;"> <p data-bbox="554 341 1265 367">▲ WARNING Risk of injury due to malfunctions in the restraint system</p> <p data-bbox="554 378 1635 409">Components in the restraint system may be activated unintentionally or not deploy as planned in an accident.</p> <p data-bbox="554 414 1524 445">► Have the restraint system checked and repaired immediately at a qualified specialist workshop.</p> </div>
 <p data-bbox="194 559 471 616">Front Left Malfunction Service Required (example)</p>	<p data-bbox="526 471 1053 497">* The restraint system is malfunctioning (→ page 44).</p> <div data-bbox="545 512 1690 626" style="border: 1px solid gray; padding: 5px;"> <p data-bbox="554 518 1265 543">▲ WARNING Risk of injury due to malfunctions in the restraint system</p> <p data-bbox="554 554 1635 585">Components in the restraint system may be activated unintentionally or not deploy as planned in an accident.</p> <p data-bbox="554 590 1524 621">► Have the restraint system checked and repaired immediately at a qualified specialist workshop.</p> </div>
 <p data-bbox="194 735 471 813">Left Window Airbag Malfunction Service Required (example)</p>	<p data-bbox="526 647 1053 673">* The restraint system is malfunctioning (→ page 44).</p> <div data-bbox="545 688 1690 823" style="border: 1px solid gray; padding: 5px;"> <p data-bbox="554 694 1469 720">▲ WARNING Risk of injury or fatal injury due to a malfunction in the window curtain airbag</p> <p data-bbox="554 730 1635 782">The window curtain airbag might be triggered unintentionally or might not be triggered at all in the event of an accident.</p> <p data-bbox="554 792 1580 823">► Have the window curtain airbag checked and repaired immediately at a qualified specialist workshop.</p> </div>



Display messages	Possible causes/consequences and ► Solutions
<p>Front Passenger Airbag Disabled See Operator's Manual</p>	<p>* The front passenger air bag and the front passenger knee bag have been disabled even though an adult or a person of adult build is on the front passenger seat. If additional forces are applied to the seat, the weight the system detects may be too low.</p> <div data-bbox="495 344 1648 550" style="border: 1px solid gray; padding: 5px;"><p>▲ WARNING Risk of injury or fatal injury due to a disabled front passenger airbag</p><p>If the front passenger airbag is disabled, the front passenger airbag will not be deployed in the event of an accident and cannot perform its intended protective function.</p><p>A person in the front passenger seat could then, for example, come into contact with the vehicle's interior, especially if the person is sitting too close to the cockpit.</p><p>► Make sure, both before and during the journey, that the status of the front passenger airbag is correct.</p></div> <ul style="list-style-type: none">► Stop the vehicle immediately in accordance with the traffic conditions.► Make sure that no objects are trapped under the front passenger seat.► Check the status of automatic front passenger air bag shutoff (→ page 46).► If necessary, consult a qualified specialist workshop immediately.
<p>Front Passenger Airbag Enabled See Operator's Manual</p>	<p>* The front passenger air bag and the front passenger knee bag will be enabled while the vehicle is in motion in the following situations:</p> <ul style="list-style-type: none">• Even when a child, a small adult or an object weighing less than the system weight threshold is located on the front passenger seat• Even when the front passenger seat is not occupied

Display messages	Possible causes/consequences and ► Solutions
	<p>The system may detect objects or forces that are adding to the weight applied to the seat.</p> <div style="border: 1px solid gray; padding: 5px;"> <p>▲ WARNING Risk of injury or death when using a child restraint system while the front passenger airbag is enabled</p> <p>If you secure a child in a child restraint system on the front passenger seat and the front passenger airbag is enabled, the front passenger airbag can deploy in the event of an accident. The child could be struck by the airbag.</p> <p>► Ensure, both before and during the journey, that the status of the front passenger airbag is correct.</p> <p>NEVER use a rearward facing child restraint on a seat protected by an ACTIVE AIRBAG in front of it, DEATH or SERIOUS INJURY to the CHILD can occur.</p> </div> <ul style="list-style-type: none"> ► Stop the vehicle immediately in accordance with the traffic conditions. ► Make sure that no objects are trapped under the front passenger seat. ► Check the status of automatic front passenger air bag shutoff (→ page 46). ► If necessary, consult a qualified specialist workshop immediately.
Occupant Presence Reminder Inoperative	<p>* The occupant presence reminder is malfunctioning</p> <ul style="list-style-type: none"> ► Consult a qualified specialist workshop.



Display messages	Possible causes/consequences and ► Solutions
 <p data-bbox="144 339 386 391">Do Not Leave People or Animals in the Vehicle</p>	<p data-bbox="469 249 1489 270">* The occupant presence reminder suspects that there are persons or animals in the rear of the vehicle.</p> <ul style="list-style-type: none"> <li data-bbox="493 280 1204 306">► Do not leave any persons or animals behind when leaving the vehicle.

SmartKey



Display messages	Possible causes/consequences and ► Solutions
 <p data-bbox="144 636 349 664">Replace Key Battery</p>	<p data-bbox="469 545 787 566">* The key battery is discharged.</p> <ul style="list-style-type: none"> <li data-bbox="493 577 861 602">► Replace the battery (→ page 76).
 <p data-bbox="144 778 391 829">Key Not Detected (white display message)</p>	<p data-bbox="469 684 805 705">* The key is currently undetected.</p> <ul style="list-style-type: none"> <li data-bbox="493 715 968 741">► Change the location of the key in the vehicle. <li data-bbox="493 752 755 778">► Try to start the vehicle. <li data-bbox="493 788 1384 814">► If the key is still not detected, place it in the slot for starting with the key (→ page 143). <li data-bbox="493 824 698 850">► Start the vehicle.





Display messages	Possible causes/consequences and ► Solutions
 <p data-bbox="194 341 462 393">Key Not Detected (red display message)</p>	<p data-bbox="517 248 1404 274">* The key can no longer be detected during a journey and may no longer be in the vehicle.</p> <p data-bbox="545 284 1191 310">If the key is no longer in the vehicle and you switch off the vehicle:</p> <ul data-bbox="545 321 942 378" style="list-style-type: none"> <li data-bbox="545 321 924 347">• You can no longer start the vehicle. <li data-bbox="545 352 942 378">• You cannot centrally lock the vehicle. <p data-bbox="545 393 933 419">► Ensure that the key is in the vehicle.</p> <p data-bbox="545 445 1034 471">If the key is in the vehicle and is still not detected:</p> <ul data-bbox="545 481 1312 543" style="list-style-type: none"> <li data-bbox="545 481 1265 507">► Stop the vehicle immediately in accordance with the traffic conditions. <li data-bbox="545 512 1312 543">► Place the key in the slot for starting the engine with the key (→ page 143). <p data-bbox="545 564 924 590">The key battery is weak or discharged.</p> <ul data-bbox="545 600 1136 663" style="list-style-type: none"> <li data-bbox="545 600 1136 626">► Check the battery using the indicator lamp (→ page 74). <li data-bbox="545 631 1081 663">► Replace the key battery, if necessary (→ page 76).
 <p data-bbox="194 771 462 797">Initializing Key Please Wait</p>	<p data-bbox="517 678 1108 704">* The vehicle is processing in order to teach in the new key.</p> <ul data-bbox="545 709 914 740" style="list-style-type: none"> <li data-bbox="545 709 914 740">► Wait until processing is complete.

370 Display messages and warning/indicator lamps

Display messages	Possible causes/consequences and ► Solutions
 <p data-bbox="144 339 369 366">Don't Forget Your Key</p>	<ul style="list-style-type: none">* A warning tone also sounds. This message reminds you to take your key with you when you leave the vehicle.
<p data-bbox="144 391 413 466">Place the Key in the Marked Space See Operator's Manual</p>	<ul style="list-style-type: none">* Key detection is malfunctioning.<ul style="list-style-type: none">► Change the location of the key in the vehicle.► Place the key in the slot for starting the engine with the key (→ page 143).
 <p data-bbox="144 591 325 618">Obtain a New Key</p>	<ul style="list-style-type: none">* Have the key replaced.<ul style="list-style-type: none">► Consult a qualified specialist workshop.

Lights

Display messages	Possible causes/consequences and ► Solutions
 <p data-bbox="194 383 434 435">Malfunction See Operator's Manual</p>	<ul style="list-style-type: none"> <li data-bbox="517 290 924 315">* The exterior lighting is malfunctioning. <li data-bbox="545 321 960 347">► Consult a qualified specialist workshop.
 <p data-bbox="194 554 443 606">Automatic Driving Lights Inoperative</p>	<ul style="list-style-type: none"> <li data-bbox="517 461 1145 486">* The light sensor for automatic driving lights is malfunctioning. <li data-bbox="545 492 960 518">► Consult a qualified specialist workshop.
 <p data-bbox="194 720 471 771">Active Headlamps Inoperative</p>	<ul style="list-style-type: none"> <li data-bbox="517 626 951 652">* The active headlamps are malfunctioning. <li data-bbox="545 657 960 683">► Consult a qualified specialist workshop.

Display messages	Possible causes/consequences and ► Solutions
 Switch On Headlights	<ul style="list-style-type: none">* You are driving without low-beam headlamps.<ul style="list-style-type: none">► Turn the light switch to the  or AUTO position.
 Switch Off Lights	<ul style="list-style-type: none">* You are leaving the vehicle and the lights are still switched on.<ul style="list-style-type: none">► Turn the light switch to the AUTO position.
MULTIBEAM LED Functions Limited	<ul style="list-style-type: none">* The MULTIBEAM LED system is malfunctioning. The lighting system will continue to work, but without the functions of the MULTIBEAM LED system.<ul style="list-style-type: none">► Consult a qualified specialist workshop.
 Dynamic Low Beam Inoperative	<ul style="list-style-type: none">* The dynamic low beam is malfunctioning. The lighting system continues to function properly without the functions of the Dynamic Light System.<ul style="list-style-type: none">► Consult a qualified specialist workshop.

Display messages	Possible causes/consequences and ► Solutions
 <p data-bbox="195 342 356 394">Check Left Low Beam (example)</p>	<ul style="list-style-type: none"> <li data-bbox="524 249 972 275">* The corresponding light source is defective. <ul style="list-style-type: none"> <li data-bbox="543 285 759 311">► Drive on carefully. <li data-bbox="543 317 1088 342">► Consult a qualified specialist workshop immediately. <li data-bbox="543 353 1689 405">① LED light sources: the display message for the corresponding light appears only when all the light-emitting diodes in the light are faulty.
<p data-bbox="195 422 463 498">Adaptive Highbeam Assist Currently Unavailable See Operator's Manual</p>	<ul style="list-style-type: none"> <li data-bbox="524 422 1058 448">* Adaptive Highbeam Assist is temporarily unavailable. <p data-bbox="543 458 1058 484">The system limits have been reached (→ page 128).</p> <p data-bbox="543 495 1631 547">Once the cause of the problem is no longer present, the system will be available again. The Adaptive Highbeam Assist Now Available display message will appear.</p> <ul style="list-style-type: none"> <li data-bbox="543 557 667 583">► Drive on <li data-bbox="543 588 1387 614">► Operate the high beam manually until Adaptive High Beam Assist is available again.
<p data-bbox="195 629 463 681">Adaptive Highbeam Assist Inoperative</p>	<ul style="list-style-type: none"> <li data-bbox="524 629 977 655">* Adaptive Highbeam Assist is malfunctioning. <ul style="list-style-type: none"> <li data-bbox="543 666 667 692">► Drive on <li data-bbox="543 697 569 723">or <li data-bbox="543 733 1369 759">► Stop the vehicle in accordance with the traffic conditions and restart the vehicle. <li data-bbox="543 764 1382 790">► If the display message does not disappear: consult a qualified specialist workshop. <li data-bbox="543 795 1005 821">► Until then, operate the high beam manually.

374 Display messages and warning/indicator lamps

Display messages	Possible causes/consequences and ► Solutions
Hazard Warning Light Malfunction	<ul style="list-style-type: none">* The hazard warning lamp switch is malfunctioning.<ul style="list-style-type: none">► Consult a qualified specialist workshop.

Drive system

Display messages	Possible causes/consequences and ► Solutions
Reduced Drive System Performance See Operator's Manual	<ul style="list-style-type: none">* The drive system switches to emergency operation mode due to a malfunction.<ul style="list-style-type: none">► Drive on carefully.► Consult a qualified specialist workshop.



Vehicle



Display messages	Possible causes/consequences and ► Solutions
	<ul style="list-style-type: none">* The driver display is inoperative due to a failed software update. The display message will be shown every time the engine is started. <p>⚠ WARNING Risk of accident if the driver's display fails</p> <p>If the driver's display fails or malfunctions, you may not be aware of any functional limitations to safety-critical systems. This may affect the operating safety of the vehicle.</p>

Display messages	Possible causes/consequences and ► Solutions
	<p>► Park the vehicle safely as soon as possible and notify a qualified specialist workshop.</p> <p>If the operating safety of your vehicle is impaired, park the vehicle immediately and safely. Contact a qualified specialist workshop.</p> <p>If the driver display fails, you may not recognize e.g. function restrictions affecting systems relevant to safety or the speed display. The operating safety of the vehicle may be impaired (→ page 245).</p> <p>► Have the vehicle checked by a qualified specialist workshop immediately.</p>
<p>Cannot Start Vehicle See Operator's Manual</p>	<p>* The vehicle cannot be started.</p> <p>► Switch the vehicle off and then back on</p> <p>► If the display message still appears, consult a qualified specialist workshop.</p> <p>* Vehicles with 48 V on-board electrical system: the state of charge of the 48 V battery is too low. You can no longer start the vehicle.</p> <p>► Switch off electrical consumers that are not required.</p> <p>► Connect a suitable charger approved for Mercedes-Benz with sufficient charge output to the jump-start connection point of the 12 V battery (→ page 311). The 48 V battery is charged via the voltage converter in the vehicle.</p>
<p>Vehicle Ready to Drive Shutdown Occurs When Locked or Automatically in XX Mins</p>	<p>* You are about to leave the vehicle and the engine is running.</p> <p>The vehicle will switch off automatically in 20 minutes.</p> <p>► To prevent the vehicle from switching off automatically, acknowledge the message on the central display of the multimedia system.</p>

Display messages	Possible causes/consequences and ► Solutions
	<p>* You are in the vehicle. Park position P is engaged and the engine is running.</p> <p>After a certain holding time, this display message will appear on the driver display. The vehicle will then switch off automatically after a total of 20 minutes of holding time.</p> <p>► To prevent the vehicle from switching off automatically, acknowledge the message on the central display of the multimedia system.</p>
<p>Vehicle Ready to Drive Shutdown Occurs When Locked or After a Few Minutes</p>	<p>* You are leaving the vehicle in a ready-to-drive state.</p> <p>► Get out of the vehicle, secure it against rolling away and take the key with you.</p> <p>► If you do not leave the vehicle, switch off the electrical consumers, e.g. the seat heating. Otherwise, the 12 V battery may discharge and starting the engine may be possible only with the help of a second battery (jump start).</p>
 <p>Add Washer Fluid</p>	<p>* The washer fluid level in the washer fluid reservoir has dropped below the minimum.</p> <p>► Add washer fluid (→ page 288).</p>
<p>Windshield Wiper Malfunction</p>	<p>* The windshield wiper is malfunctioning.</p> <p>► Restart the vehicle.</p> <p>If the display message still appears:</p> <p>► Consult a qualified specialist workshop.</p>

Display messages	Possible causes/consequences and ► Solutions
<p>Head-up Display Currently Unavailable See Operator's Manual</p>	<p>* The head-up display is temporarily unavailable. Possible causes:</p> <ul style="list-style-type: none"> • Malfunctions in the power supply • Signal interference <p>► Stop in accordance with the traffic conditions and switch the vehicle off and on again.</p> <p>► If the display message still appears, consult a qualified specialist workshop.</p>
<p>Head-up Display Inoperative</p>	<p>* The head-up display has an internal error.</p> <p>► Consult a qualified specialist workshop.</p>
<p> Steering Malfunction Stop Immediately See Operator's Manual</p>	<p>* The steering is malfunctioning. Steering capability is significantly impaired.</p> <div style="background-color: #f0f0f0; padding: 5px; border: 1px solid #ccc;"> <p>▲ WARNING Risk of accident if steering capability is impaired</p> <p>If the steering does not function as intended, the vehicle's operating safety is jeopardized.</p> <ul style="list-style-type: none"> ► Pull over and stop the vehicle safely as soon as possible, paying attention to road and traffic conditions. Do not continue driving under any circumstances. ► Consult a qualified specialist workshop. </div>



Display messages	Possible causes/consequences and ► Solutions
 <p data-bbox="144 339 397 417">Steering Malfunction Increased Physical Effort See Operator's Manual</p>	<p data-bbox="476 246 966 272">* The power steering assistance is malfunctioning.</p> <div data-bbox="500 291 1648 443" style="border: 1px solid gray; padding: 5px;"> <p data-bbox="506 298 1221 324">▲ WARNING Risk of an accident due to altered steering characteristics</p> <p data-bbox="506 337 1554 363">If the power assistance of the steering fails partially or completely, you will need to use more force to steer.</p> <ul style="list-style-type: none"> <li data-bbox="506 370 981 396">▶ If safe steering is possible, drive on carefully. <li data-bbox="506 405 1123 430">▶ Visit or consult a qualified specialist workshop immediately. </div>
 <p data-bbox="144 552 397 598">Steering Malfunction See Operator's Manual</p>	<p data-bbox="476 458 1471 484">* The electric steering lock is malfunctioning. The steering may be locked by the electric steering lock.</p> <div data-bbox="500 503 1648 681" style="border: 1px solid gray; padding: 5px;"> <p data-bbox="506 510 1129 536">▲ WARNING Risk of accident if steering capability is impaired</p> <p data-bbox="506 550 1387 576">If the steering does not function as intended, the vehicle's operating safety is jeopardized.</p> <ul style="list-style-type: none"> <li data-bbox="506 583 1591 635">▶ Pull over and stop the vehicle safely as soon as possible, paying attention to road and traffic conditions. Do not continue driving under any circumstances. <li data-bbox="506 643 931 669">▶ Consult a qualified specialist workshop. </div> <ul style="list-style-type: none"> <li data-bbox="495 697 1452 723">▶ Stop the vehicle immediately in accordance with the traffic conditions. Do not continue driving. <li data-bbox="495 731 912 757">▶ Consult a qualified specialist workshop.

Display messages	Possible causes/consequences and ► Solutions
 <p data-bbox="195 342 473 394">Turn Steering Wheel Before Starting Vehicle</p>	<ul style="list-style-type: none"> * The electric steering lock could not unlock the steering. <ul style="list-style-type: none"> ► Switch off the vehicle. ► To unlock the steering, move the steering wheel slightly to the left and right. ► Switch on the vehicle again.
	<ul style="list-style-type: none"> * The hood is open. <div style="border: 1px solid gray; padding: 5px; margin-top: 10px;"> <p>⚠ WARNING Risk of accident due to driving with the hood unlocked</p> <p>The hood may open and block your view.</p> <ul style="list-style-type: none"> ► Never release the hood when driving. ► Before every trip, ensure that the hood is locked. </div> <ul style="list-style-type: none"> ► Stop the vehicle immediately in accordance with the traffic conditions. ► Close the hood.
	<ul style="list-style-type: none"> * At least one door is open. <ul style="list-style-type: none"> ► Close all doors.



Display messages	Possible causes/consequences and ► Solutions
	<p>* The trunk lid is open.</p> <p>▲ DANGER Risk of exhaust gas poisoning</p> <p>Combustion engines emit poisonous exhaust gases such as carbon monoxide. Exhaust gases can enter the vehicle interior if the trunk lid is open when the engine is running, especially if the vehicle is in motion.</p> <ul style="list-style-type: none">► Always switch off the engine before opening the trunk lid.► Never drive with the trunk lid open. <p>► Close the trunk lid.</p>

Engine

Display messages	Possible causes/consequences and ► Solutions
<p>To Switch Off Vehicle Press and Hold Start/Stop Button for at Least 3 Sec- onds or Press 3 Times</p>	<p>* You have pressed the start/stop button while the vehicle is in motion.</p> <p>► Information about switching off the vehicle while it is being driven (→ page 142).</p>

Display messages	Possible causes/consequences and ► Solutions
 <p data-bbox="194 341 452 388">Check Coolant Level See Operator's Manual</p>	<p data-bbox="526 248 813 269">* The coolant level is too low.</p> <div data-bbox="545 290 1690 378" style="border: 1px solid gray; padding: 5px;"> <p data-bbox="554 300 1081 326">! NOTE Engine damage due to insufficient coolant</p> <p data-bbox="563 336 1034 367">► Avoid long journeys with insufficient coolant.</p> </div> <p data-bbox="545 388 850 419">► Add coolant (→ page 287).</p> <p data-bbox="545 424 1312 455">► Have the engine cooling system checked at a qualified specialist workshop.</p>
 <p data-bbox="194 564 443 611">Coolant Stop Switch Off Vehicle</p>	<p data-bbox="526 471 766 492">* The coolant is too hot.</p> <p data-bbox="545 502 1413 533">► Stop immediately in accordance with the traffic conditions and switch off the vehicle.</p> <div data-bbox="545 554 1690 813" style="border: 1px solid gray; padding: 5px;"> <p data-bbox="554 564 1081 590">▲ WARNING Risk of burns when opening the hood</p> <p data-bbox="563 606 1653 657">If you open the hood in the event of an overheated engine or fire in the engine compartment, the following situations may occur:</p> <ul data-bbox="563 668 1265 730" style="list-style-type: none"> <li data-bbox="563 668 1016 694">• You may come into contact with hot gases. <li data-bbox="563 699 1265 730">• You may come into contact with other escaping hot operating fluids. <p data-bbox="563 740 1155 771">► Before opening the hood, allow the engine to cool down.</p> <p data-bbox="563 777 1524 808">► In the event of a fire in the engine compartment, keep the hood closed and call the fire service.</p> </div> <p data-bbox="545 828 960 859">► Wait until the engine has cooled down.</p>

382 Display messages and warning/indicator lamps

Display messages	Possible causes/consequences and ► Solutions
 Fuel Reserve	<ul style="list-style-type: none">► Make sure that the air supply to the radiator is not obstructed.► Avoiding high loads on the engine, drive to the nearest qualified specialist workshop. In doing so, ensure that the coolant temperature display remains below the red marking.
 Fuel Reserve	<ul style="list-style-type: none">* The fuel supply has dropped into the reserve range.<ul style="list-style-type: none">► Refuel.
 Fuel Filler Cap Open	<ul style="list-style-type: none">* The fuel filler cap is not closed correctly or the fuel system is leaking.<ul style="list-style-type: none">► Close the fuel filler cap.► If the fuel filler cap was already properly closed: consult a qualified specialist workshop.

Transmission

Display messages	Possible causes/consequences and ► Solutions
Shift to P Only When Vehicle Is Stationary	<ul style="list-style-type: none">* It is possible to select the park position P only if the vehicle is stationary.<ul style="list-style-type: none">► Depress the brake pedal to stop.► Shift the transmission to park position P when the vehicle is stationary.

Display messages	Possible causes/consequences and ► Solutions
Depress Brake to Shift from P	<ul style="list-style-type: none"> * You have attempted to shift the transmission out of park position P and into another transmission position. <ul style="list-style-type: none"> ► Depress the brake pedal. ► Select transmission position D, R or neutral N.
To Deselect P or N Depress Brake and Start Vehicle	<ul style="list-style-type: none"> * You have attempted to shift the transmission out of park position P or neutral N and into another transmission position. <ul style="list-style-type: none"> ► Depress the brake pedal. ► Start the vehicle. ► Change the transmission position.
Depress Brake to Shift to D or R	<ul style="list-style-type: none"> * You have attempted to select transmission position D or R. <ul style="list-style-type: none"> ► Depress the brake pedal. ► Select transmission position D or R.
Depress Brake to Shift to R	<ul style="list-style-type: none"> * You have attempted to select transmission position R. <ul style="list-style-type: none"> ► Depress the brake pedal. ► Select transmission position R.
Service Required Apply Parking Brake to Park	<ul style="list-style-type: none"> * A malfunction has occurred in the emergency power supply to park position P. <ul style="list-style-type: none"> ► Consult a qualified specialist workshop. ► Until then, always select park position P manually before you switch off the vehicle. ► Before leaving the vehicle, apply the electric parking brake.





Display messages	Possible causes/consequences and ► Solutions
Risk of Vehicle Rolling Away Driver's Door Open Position P Not Selected	<ul style="list-style-type: none"> * The driver's door is not fully closed and transmission position D, R or neutral N is selected. The vehicle may roll away. <ul style="list-style-type: none"> ► Select park position P when switching off the vehicle.
Risk of Vehicle Rolling Away Apply Parking Brake When Parking	<ul style="list-style-type: none"> * The transmission is malfunctioning. Park position P cannot be selected. <ul style="list-style-type: none"> ► Park the vehicle safely. ► Use the electric parking brake to secure the vehicle against rolling away. ► On gradients, turn the front wheels so that the vehicle will roll towards the curb if it starts moving.
N Permanently Active Risk of Rolling Away	<ul style="list-style-type: none"> * Neutral N has been engaged while the vehicle is moving or while you are driving. <ul style="list-style-type: none"> ► Depress the brake pedal to stop. ► Shift the transmission to park position P when the vehicle is stationary. ► To continue driving, select transmission position D or R.
Reversing Not Possible Service Required	<ul style="list-style-type: none"> * The transmission is malfunctioning. It is not possible to select transmission position R. <ul style="list-style-type: none"> ► Consult a qualified specialist workshop.
Transmission Malfunction Stop	<ul style="list-style-type: none"> * The transmission is malfunctioning. The transmission shifts to neutral N automatically. <ul style="list-style-type: none"> ► Stop the vehicle immediately in accordance with the traffic conditions. ► Depress the brake pedal. ► Engage park position P.





Display messages	Possible causes/consequences and ► Solutions
<p data-bbox="195 288 469 363">Service Required Do Not Change Transmission Position</p>	<ul style="list-style-type: none"> <li data-bbox="543 246 962 272">► Consult a qualified specialist workshop. <li data-bbox="524 288 1692 313">* The transmission is malfunctioning. It is no longer possible to change the transmission position. <li data-bbox="543 324 1692 376">► If transmission position [D] is selected, consult a qualified specialist workshop and do not change the transmission position. <li data-bbox="543 386 1156 412">► For all other transmission positions, park the vehicle safely. <li data-bbox="543 422 1179 448">► Consult a qualified specialist workshop or breakdown service.
<p data-bbox="195 462 454 487">Transmission Malfunction</p>	<ul style="list-style-type: none"> <li data-bbox="524 462 1467 487">* The transmission is malfunctioning. The cause could be an overheated clutch or blocked gears. <li data-bbox="543 498 888 524">► Let the transmission cool down. <li data-bbox="543 534 1493 560">► If the display message still appears following a restart, consult a qualified specialist workshop.
<div data-bbox="205 573 362 656" style="border: 1px solid black; padding: 5px; text-align: center;">  </div> <p data-bbox="195 667 463 718">Transmission Oil Overheated Drive with Caution</p>	<ul style="list-style-type: none"> <li data-bbox="524 573 1683 625">* The transmission is overheating. When the display message is active, start-up and driving characteristics may be temporarily impaired. <li data-bbox="543 636 838 662">► Drive at low engine speed. <li data-bbox="543 672 778 698">► Avoid sporty driving. <li data-bbox="543 708 1633 734">► Before pulling away on uphill gradients, let the transmission cool down until the display message disappears.



Display messages	Possible causes/consequences and ► Solutions
 Parking Lock Inoperative Apply Parking Brake	<ul style="list-style-type: none"> * The transmission is malfunctioning. Park position P cannot be selected. <ul style="list-style-type: none"> ► Park the vehicle safely. ► Use the electric parking brake to secure the vehicle against rolling away.
Teaching in Transmission Operate Selector Lever Apply Brake for XX s Risk of Vehicle Rolling Away	<ul style="list-style-type: none"> * The transmission is being taught in. There is a risk of the vehicle rolling away. <ul style="list-style-type: none"> ► Depress and hold the brake pedal until the teach-in process has been completed. The electric parking brake will be applied automatically during the teach-in process. ► Switch on the vehicle. ► Select park position P, transmission position R or neutral N.
Teaching in Transmission Complete	<ul style="list-style-type: none"> * The transmission's teach-in process is complete. All transmission positions can be selected again.
Transmission Malfunction Service Required	<ul style="list-style-type: none"> * The transmission is malfunctioning. Consult a qualified specialist workshop.
Auxiliary Battery Malfunction (white display message)	<ul style="list-style-type: none"> * There is a malfunction in the auxiliary battery. <ul style="list-style-type: none"> ► Consult a qualified specialist workshop. ► Until then, always select park position P manually before you switch off the vehicle. ► Before leaving the vehicle, apply the electric parking brake.



Display messages	Possible causes/consequences and ► Solutions
<p>Auxiliary Battery Malfunction (red display message)</p>	<p>* There is a malfunction in the auxiliary battery.</p> <ul style="list-style-type: none"> ► Consult a qualified specialist workshop. ► Until then, always select park position P manually before you switch off the vehicle. ► Before leaving the vehicle, apply the electric parking brake.







Brakes

Display messages	Possible causes/consequences and ► Solutions
<div data-bbox="205 526 362 607" style="border: 1px solid black; padding: 5px; text-align: center; font-weight: bold; font-size: 1.2em;">PARK</div> <p>(USA only)</p> <div data-bbox="205 653 362 734" style="border: 1px solid black; padding: 5px; text-align: center; font-weight: bold; font-size: 1.2em;">(P)</div> <p>(Canada only)</p> <p>Parking Brake See Operator's Manual</p>	<p>* The yellow  indicator lamp is lit. The electric parking brake is malfunctioning.</p> <p>To apply:</p> <ul style="list-style-type: none"> ► Switch the vehicle off and then back on ► Apply the electric parking brake manually (→ page 170). <p>If it is not possible to apply the electric parking brake:</p> <ul style="list-style-type: none"> ► Consult a qualified specialist workshop. ► Where necessary, also secure the parked vehicle against rolling away. <p>* The yellow  indicator lamp and the red  (USA only) or  (Canada only) indicator lamp are lit. The electric parking brake is malfunctioning.</p> <p>To release:</p>

Display messages	Possible causes/consequences and ► Solutions
	<ul style="list-style-type: none"> ► Switch the vehicle off and then back on ► Release the electric parking brake manually (→ page 170). <p>or</p> <ul style="list-style-type: none"> ► Release the electric parking brake automatically (→ page 169). <p>If it is still not possible to release the electric parking brake:</p> <ul style="list-style-type: none"> ► Do not continue driving. Consult a qualified specialist workshop. <p>* The yellow  indicator lamp is lit and the red  (USA only) or  (Canada only) indicator lamp is flashing. The electric parking brake is malfunctioning. The electric parking brake could not be applied or released.</p> <ul style="list-style-type: none"> ► Switch the vehicle off and then back on <p>To apply:</p> <ul style="list-style-type: none"> ► Release and then apply the electric parking brake manually (→ page 170). <p>To release:</p> <ul style="list-style-type: none"> ► Apply and then release the electric parking brake manually. <p>If the electric parking brake cannot be applied or the red  (USA only) or  (Canada only) indicator lamp continues to flash:</p> <ul style="list-style-type: none"> ► Do not continue driving. Consult a qualified specialist workshop. ► Where necessary, also secure the parked vehicle against rolling away.

Display messages	Possible causes/consequences and ► Solutions
	<p>* The yellow  indicator lamp is lit and the red  indicator lamp (USA only) or  indicator lamp (Canada only) flashes for approximately ten seconds after the electric parking brake has been applied or released. It then remains lit or goes out. The electric parking brake is malfunctioning.</p> <p>If the state of charge is too low:</p> <ul style="list-style-type: none">► Charge the 12 V battery (→ page 311). <p>To apply:</p> <ul style="list-style-type: none">► Switch off the vehicle. The electric parking brake will be applied automatically. <p>If you do not want the electric parking brake to be applied, e.g. at an automatic car wash or when the vehicle is being towed, leave the vehicle switched on. This does not include having the vehicle towed with the rear axle raised.</p> <p>If the electric parking brake is not applied automatically:</p> <ul style="list-style-type: none">► Switch the vehicle off and then back on► Release and then apply the electric parking brake manually (→ page 170). <p>If it is still not possible to apply the electric parking brake:</p> <ul style="list-style-type: none">► Consult a qualified specialist workshop.► Where necessary, also secure the parked vehicle against rolling away. <p>To release:</p>

Display messages	Possible causes/consequences and ► Solutions
	<ul style="list-style-type: none"> ► If the conditions for automatic release are fulfilled and the electric parking brake is not released automatically, release the electric parking brake manually (→ page 170). <p>If it is still not possible to release the electric parking brake:</p> <ul style="list-style-type: none"> ► Do not continue driving. Consult a qualified specialist workshop.
<div style="border: 1px solid black; padding: 5px; text-align: center; width: fit-content; margin-bottom: 5px;"> PARK </div> <p>(USA only)</p> <div style="border: 1px solid black; padding: 5px; text-align: center; width: fit-content; margin-bottom: 5px;">  </div> <p>(Canada only)</p> <p>Release Parking Brake</p>	<p>* The red PARK indicator lamp (USA only) or  indicator lamp (Canada only) is flashing.</p> <p>The electric parking brake is applied while you are driving:</p> <ul style="list-style-type: none"> • A condition for automatic release of the electric parking brake has not been fulfilled (→ page 169). • You are performing emergency braking using the electric parking brake (→ page 170). <ul style="list-style-type: none"> ► Check the conditions for automatic release of the electric parking brake. ► Release the electric parking brake manually.



Display messages	Possible causes/consequences and ► Solutions
<div data-bbox="205 249 362 332"></div> <div data-bbox="199 339 306 366">(USA only)</div> <div data-bbox="205 377 362 459"></div> <div data-bbox="199 467 338 494">(Canada only)</div> <div data-bbox="194 501 462 553">Switch on Vehicle to Release the Parking Brake</div>	<ul style="list-style-type: none"> * The red  (USA only) or  (Canada only) indicator lamp is lit. You have attempted to release the electric parking brake with the vehicle switched off. <ul style="list-style-type: none"> ► Switch on the vehicle.
<div data-bbox="205 581 362 664"></div> <div data-bbox="194 671 301 698">(USA only)</div> <div data-bbox="205 708 362 791"></div> <div data-bbox="194 798 332 825">(Canada only)</div> <div data-bbox="194 832 437 855">Check Brake Fluid Level</div>	<ul style="list-style-type: none"> * There is insufficient brake fluid in the brake fluid reservoir. <div data-bbox="550 622 1696 835" style="border: 1px solid black; padding: 5px;"> <div data-bbox="550 622 1696 660" style="background-color: #e0e0e0; padding: 2px;">▲ WARNING Risk of an accident due to low brake fluid level</div> <p data-bbox="563 671 1535 698">If the brake fluid level is too low, the braking effect and the braking characteristics may be impaired.</p> <ul style="list-style-type: none"> ► Pull over and stop the vehicle safely as soon as possible, paying attention to road and traffic conditions. Do not continue driving under any circumstances. ► Consult a qualified specialist workshop. ► Do not add brake fluid. </div>

392 Display messages and warning/indicator lamps

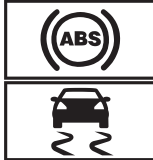

Display messages	Possible causes/consequences and ► Solutions
Check Brake Pads See Operator's Manual	<ul style="list-style-type: none">* The brakepads have reached the wear limit.<ul style="list-style-type: none">► Consult a qualified specialist workshop.

Driving and driving safety systems

Display messages	Possible causes/consequences and ► Solutions
 <p data-bbox="144 629 408 681">Currently Unavailable See Operator's Manual</p>	<ul style="list-style-type: none">* ABS and ESP[®] are temporarily unavailable. Other driving systems and driving safety systems (e.g. BAS) may also be temporarily unavailable. The brake system will continue to operate normally. Braking distance may increase in an emergency braking situation. <div data-bbox="495 567 1644 837"><p>▲ WARNING Risk of skidding if ABS and ESP[®] are malfunctioning</p><p>The wheels may lock during braking and ESP[®] does not perform any vehicle stabilization. The steerability and braking characteristics are heavily impaired and the braking distance may increase. In addition, other driving safety systems are switched off.</p><ul style="list-style-type: none">► Drive carefully on a suitable stretch of road, making slight steering movements at a speed above 19 mph (30 km/h).► If the display message does not disappear, consult a qualified specialist workshop immediately. Drive carefully.</div>

Display messages	Possible causes/consequences and ► Solutions
 <p data-bbox="195 427 467 474">Inoperative See Operator's Manual</p>	<p data-bbox="524 249 1692 346">* ABS and ESP[®] are malfunctioning. Other driving systems and driving safety systems (e.g. BAS) may also be malfunctioning. The brake system will continue to operate normally. Braking distance may increase in an emergency braking situation.</p> <div data-bbox="550 363 1692 581" style="border: 1px solid black; padding: 5px;"> <p data-bbox="559 370 1217 401">▲ WARNING Risk of skidding if ABS and ESP[®] are malfunctioning</p> <p data-bbox="559 415 1443 441">The wheels may block during braking and ESP[®] does not perform any vehicle stabilization.</p> <p data-bbox="559 451 1650 500">The steerability and braking characteristics are heavily impaired and the braking distance may increase. In addition, other driving safety systems are switched off.</p> <ul style="list-style-type: none"> <li data-bbox="559 510 774 536">► Drive on carefully. <li data-bbox="559 547 1341 572">► Have ABS and ESP[®] checked immediately at a qualified specialist workshop. </div>
 <p data-bbox="195 692 458 738">Currently Unavailable See Operator's Manual</p>	<p data-bbox="524 598 1402 660">* ESP[®] is temporarily unavailable. Other driving systems and driving safety systems (e.g. BAS) may also be malfunctioning.</p> <div data-bbox="550 678 1692 844" style="border: 1px solid black; padding: 5px;"> <p data-bbox="559 685 1112 716">▲ WARNING Risk of skidding if ESP is malfunctioning[®]</p> <p data-bbox="559 730 1670 779">If ESP[®] is malfunctioning, ESP[®] cannot carry out vehicle stabilization. In addition, other driving safety systems are switched off.</p> <ul style="list-style-type: none"> <li data-bbox="559 789 1615 841">► Drive carefully on a suitable stretch of road, making slight steering movements at a speed above 19 mph (30 km/h). </div>

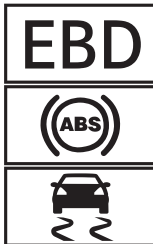

Display messages	Possible causes/consequences and ► Solutions
	<p>► If the display message does not disappear, consult a qualified specialist workshop immediately. Drive carefully.</p>
 <p>Inoperative See Operator's Manual</p>	<p>* ESP® is malfunctioning. Other driving systems and driving safety systems (e.g. BAS) may also be malfunctioning. The brake system will continue to operate normally. Braking distance may increase in an emergency braking situation.</p> <p>⚠ WARNING Risk of skidding if ESP® is malfunctioning</p> <p>If ESP® is malfunctioning, ESP® cannot carry out vehicle stabilization. In addition, other driving safety systems are switched off.</p> <ul style="list-style-type: none">► Drive on carefully.► Have ESP® checked at a qualified specialist workshop.

Display messages	Possible causes/consequences and ► Solutions
 <p data-bbox="194 512 471 564">Inoperative See Operator's Manual</p>	<p data-bbox="526 248 1404 310">* EBD, ABS and ESP® are malfunctioning. Other driving systems and driving safety systems (e.g. BAS) may also be malfunctioning.</p> <div data-bbox="545 326 1690 543" style="border: 1px solid gray; padding: 5px;"> <p data-bbox="554 336 1275 367">▲ WARNING Risk of skidding if EBD, ABS and ESP® are malfunctioning</p> <p data-bbox="563 378 1441 409">The wheels may block during braking and ESP® does not perform any vehicle stabilization.</p> <p data-bbox="563 414 1653 466">The steerability and braking characteristics are heavily impaired and the braking distance may increase. In addition, other driving safety systems are switched off.</p> <ul data-bbox="563 471 1367 533" style="list-style-type: none"> <li data-bbox="563 471 776 502">► Drive on carefully. <li data-bbox="563 507 1367 533">► Have the brake system checked immediately at a qualified specialist workshop. </div>
 <p data-bbox="194 678 231 704">Off</p>	<p data-bbox="526 585 1635 647">* The HOLD function is deactivated because the vehicle is slipping or a condition for activation is not fulfilled. ► Reactivate the HOLD function later or check the activation conditions for the HOLD function (→ page 177).</p>
 <p data-bbox="194 818 471 870">ATTENTION ASSIST: Take a Break!</p>	<p data-bbox="526 725 1552 782">* ATTENTION ASSIST has detected fatigue or an increasing lack of concentration on the part of the driver (→ page 179).</p> <ul data-bbox="545 787 840 813" style="list-style-type: none"> <li data-bbox="545 787 840 813">► If necessary, take a break.

Display messages	Possible causes/consequences and ► Solutions
 <p>--- mph</p>	<ul style="list-style-type: none"> * Cruise control cannot be activated because not all activation conditions are fulfilled. <ul style="list-style-type: none"> ► Observe the activation conditions for cruise control (→ page 182).
Cruise Control Inoperative	<ul style="list-style-type: none"> * Cruise control is malfunctioning. <ul style="list-style-type: none"> ► Consult a qualified specialist workshop.
Cruise Control Off	<ul style="list-style-type: none"> * Cruise control has been deactivated. <ul style="list-style-type: none"> If there is an additional warning tone, cruise control has been deactivated automatically (→ page 181).
Traffic Sign Assist Currently Unavailable See Operator's Manual	<ul style="list-style-type: none"> * Traffic Sign Assist is temporarily unavailable. <ul style="list-style-type: none"> Once the cause of the problem is no longer present, the system will be available again. ► Continue driving in compliance with the traffic regulations.
Traffic Sign Assist Inoperative	<ul style="list-style-type: none"> * Traffic Sign Assist is malfunctioning. <ul style="list-style-type: none"> ► Continue driving in compliance with the traffic regulations. or ► Stop the vehicle in accordance with the traffic conditions and restart the vehicle. ► If the display message does not disappear: consult a qualified specialist workshop.

Display messages	Possible causes/consequences and ► Solutions
 <p data-bbox="194 336 471 393">Malfunction Do Not Exceed 50 mph</p>	<ul style="list-style-type: none"> <li data-bbox="526 248 1496 274">* The adjustable damping is malfunctioning. The vehicle's handling characteristics may be affected. <ul style="list-style-type: none"> <li data-bbox="545 279 1118 305">► Do not drive at speeds greater than 50 mph (80 km/h). <li data-bbox="545 310 970 336">► Consult a qualified specialist workshop.

Driver assistance systems



Display messages	Possible causes/consequences and ► Solutions
 <p data-bbox="194 637 286 663">--- mph</p>	<ul style="list-style-type: none"> <li data-bbox="526 543 1561 569">* Active Distance Assist DISTRONIC cannot be activated because not all activation conditions are fulfilled. <ul style="list-style-type: none"> <li data-bbox="545 574 1469 600">► Comply with the activation conditions of Active Distance Assist DISTRONIC (→ page 186).
 <p data-bbox="194 777 314 802">Suspended</p>	<ul style="list-style-type: none"> <li data-bbox="526 683 1690 740">* If you depress the accelerator pedal beyond the setting of Active Distance Assist DISTRONIC, the system will switch to passive mode (→ page 183).

Display messages	Possible causes/consequences and ► Solutions
 <p>Off</p>	<p>* Active Distance Assist DISTRONIC was deactivated. If a warning tone also sounds, Active Distance Assist DISTRONIC has deactivated automatically (→ page 186).</p>
<p>Active Distance Assist Currently Unavailable See Operator's Manual</p>	<p>* Active Distance Assist DISTRONIC is temporarily unavailable. The ambient conditions are outside the system limits (→ page 183). As soon as the ambient conditions are within the system limits, the system will become available again.</p> <ul style="list-style-type: none"> ► Drive on carefully. or ► If the display message does not disappear, stop the vehicle in accordance with the traffic conditions and restart the vehicle.
<p>Active Distance Assist Inoperative</p>	<p>* Active Distance Assist DISTRONIC and Active Emergency Stop Assist are malfunctioning. Other driving systems and driving safety systems may also be malfunctioning.</p> <ul style="list-style-type: none"> ► Drive on carefully. or ► Stop the vehicle in accordance with the traffic conditions and restart the vehicle. ► If the display message does not disappear: consult a qualified specialist workshop.

Display messages	Possible causes/consequences and ► Solutions
Active Distance Assist Now Available	<ul style="list-style-type: none"> * Active Distance Assist DISTRONIC is operational again. <ul style="list-style-type: none"> ► Switch on Active Distance Assist DISTRONIC (→ page 186).
Active Brake Assist Functions Currently Limited See Operator's Manual	<ul style="list-style-type: none"> * For vehicles with the Driving Assistance Package, the following functions may be temporarily unavailable or only partially available: <ul style="list-style-type: none"> • Active Brake Assist • Active Evasive Steering Assist <p>The ambient conditions are outside the system limits (→ page 194).</p> <p>Vehicles without the Driving Assistance Package: Active Brake Assist is temporarily unavailable.</p> <ul style="list-style-type: none"> ► Drive on carefully. <p>As soon as the ambient conditions are within the system limits, the system will become available again.</p> <p>or</p> <ul style="list-style-type: none"> ► If the display message does not disappear, stop the vehicle in accordance with the traffic conditions and restart the vehicle.
Active Brake Assist Functions Limited See Operator's Manual	<ul style="list-style-type: none"> * For vehicles with the Driving Assistance Package, the following functions may be temporarily unavailable or only partially available: <ul style="list-style-type: none"> • Active Brake Assist • Active Evasive Steering Assist





400 Display messages and warning/indicator lamps



Display messages	Possible causes/consequences and ► Solutions
	<p>Vehicles without the Driving Assistance Package: Active Brake Assist is temporarily unavailable or only partially available.</p> <ul style="list-style-type: none">► Drive on carefully. <p>or</p> <ul style="list-style-type: none">► Stop the vehicle in accordance with the traffic conditions and restart the vehicle.► If the display message does not disappear: consult a qualified specialist workshop.
<p>Active Steering Assist Currently Unavailable See Operator's Manual</p>	<p>* Active Steering Assist is temporarily unavailable.</p> <p>The ambient conditions are outside the system limits (→ page 190).</p> <p>As soon as the ambient conditions are within the system limits, the system will become available again.</p> <ul style="list-style-type: none">► Drive on► Check the tire pressure if necessary.
<p>Active Steering Assist Inoperative</p>	<p>* Active Steering Assist and Active Emergency Stop Assist are malfunctioning. Active Distance Assist DISTRONIC remains available.</p> <ul style="list-style-type: none">► Drive on <p>or</p> <ul style="list-style-type: none">► Stop the vehicle in accordance with the traffic conditions and restart the vehicle.► If the display message does not disappear: consult a qualified specialist workshop.

Display messages	Possible causes/consequences and ► Solutions
	<ul style="list-style-type: none"> * Active Steering Assist has reached the system limits (→ page 190). You have not steered independently for a considerable period of time. <ul style="list-style-type: none"> ► Take over the steering and drive on in accordance with the traffic conditions.
<p>Active Steering Assist Currently Unavailable Due to Multiple Emergency Stops</p>	<ul style="list-style-type: none"> * Active Steering Assist is temporarily unavailable due to multiple emergency stops. <ul style="list-style-type: none"> ► Take over the steering and stop in accordance with the traffic conditions. ► Switch the vehicle off and then back on Active Steering Assist is available once more.
 <p>Initiating Emergency Stop</p>	<ul style="list-style-type: none"> * Your hands are not on the steering wheel. An emergency stop will be initiated (→ page 190). <ul style="list-style-type: none"> ► Make a deliberate steering movement. ► Accelerate or brake. <p>Information on canceling an emergency stop (→ page 192).</p>
<p>Blind Spot Assist Currently Unavailable See Operator's Manual</p>	<ul style="list-style-type: none"> * Blind Spot Assist is temporarily unavailable. The system limits have been reached (→ page 202). Once the cause of the problem is no longer present, the system will be available again. <ul style="list-style-type: none"> ► Drive on <p>or</p>

402 Display messages and warning/indicator lamps

Display messages	Possible causes/consequences and ► Solutions
	<ul style="list-style-type: none">► If the display message does not disappear, stop the vehicle in accordance with the traffic conditions and restart the vehicle.
Blind Spot Assist Inoperative	<ul style="list-style-type: none">* Blind Spot Assist or the exit warning is malfunctioning.<ul style="list-style-type: none">► Drive onor► Stop the vehicle in accordance with the traffic conditions and restart the vehicle.► If the display message does not disappear: consult a qualified specialist workshop.
Active Lane Keeping Assist Currently Unavailable See Operator's Manual	<ul style="list-style-type: none">* Active Lane Keeping Assist is temporarily unavailable. The ambient conditions are outside the system limits (→ page 204). As soon as the ambient conditions are within the system limits, the system will become available again.<ul style="list-style-type: none">► Drive on
Active Lane Keeping Assist Inoperative	<ul style="list-style-type: none">* Active Lane Keeping Assist and Active Emergency Stop Assist are malfunctioning.<ul style="list-style-type: none">► Drive onor► Stop the vehicle in accordance with the traffic conditions and restart the vehicle.► If the display message does not disappear: consult a qualified specialist workshop.

Display messages	Possible causes/consequences and ► Solutions
<p>Active Lane Keeping Assist Limited Range of Functions See Operator's Manual</p>	<p>* Active Lane Keeping Assist is available but restricted.</p> <ul style="list-style-type: none"> ► Drive on or ► Stop the vehicle in accordance with the traffic conditions and restart the vehicle. ► If the display message does not disappear: consult a qualified specialist workshop.
<div style="display: flex; flex-direction: column; align-items: center;">     </div> <p>Temporarily Unavailable Sensors Dirty</p>	<p>* Front and corner radar sensors (hereafter "sensors") are malfunctioning. Possible causes:</p> <ul style="list-style-type: none"> • The sensors are dirty • Heavy rain or snow • Extended country driving without other traffic, e.g. in the desert <p>Driving systems and driving safety systems may be malfunctioning or temporarily unavailable. The brake system, steering and drive system will continue to function normally.</p> <ul style="list-style-type: none"> ► Drive on carefully. <p>Once the causes of the problem are no longer present, the driving systems and driving safety systems will be available again and the corresponding symbols will be switched off.</p> <p>If the display message does not disappear:</p> <ul style="list-style-type: none"> ► Stop the vehicle in accordance with the traffic conditions. ► Clean all sensor covers from the outside (→ page 173). ► Restart the vehicle.

Display messages	Possible causes/consequences and ► Solutions
 <p data-bbox="144 767 417 816">Camera View Reduced See Operator's Manual</p>	<p data-bbox="476 249 1147 272">* The view of the multifunction camera is restricted. Possible causes:</p> <ul data-bbox="500 285 1628 405" style="list-style-type: none"> <li data-bbox="500 285 1215 308">• Dirt on the windshield in the field of vision of the multifunction camera <li data-bbox="500 319 759 341">• Heavy rain, snow or fog <li data-bbox="500 352 1628 405">• Mist on the inside or outside of the windshield: in certain weather conditions, mist can form on the inside or outside of the windshield during cold times of year in particular. <p data-bbox="495 420 1628 474">  This mist on the windshield will be removed automatically within a short time with the aid of a heater. The restriction is temporary. </p> <p data-bbox="495 484 1646 536">Driving systems and driving safety systems may be malfunctioning or temporarily unavailable. The brake system, steering and drive system will continue to function normally.</p> <ul data-bbox="495 547 1142 643" style="list-style-type: none"> <li data-bbox="495 547 704 569">► Drive on carefully. <li data-bbox="495 580 1105 602">► To remove mist from the outside, wipe once (→ page 131). <li data-bbox="495 613 1142 643">► To remove the mist from the inside, press  (→ page 139). <p data-bbox="495 669 1646 721">Once the causes of the problem are no longer present, the driving systems and driving safety systems will be available again and the corresponding symbols will be switched off.</p> <p data-bbox="495 731 1350 754">If the display message does not disappear even after a driving time of about 15 minutes:</p> <ul data-bbox="495 764 1406 855" style="list-style-type: none"> <li data-bbox="495 764 1092 787">► Stop the vehicle in accordance with the traffic conditions. <li data-bbox="495 797 1406 820">► Clean the windshield, especially in the position of the multifunction camera (→ page 173). <li data-bbox="495 830 717 853">► Restart the vehicle.

Display messages	Possible causes/consequences and ► Solutions
PRE-SAFE Inoperative See Operator's Manual	<ul style="list-style-type: none"> * The PRE-SAFE® functions are malfunctioning. <ul style="list-style-type: none"> ► Consult a qualified specialist workshop.

Parking assistance systems



Display messages	Possible causes/consequences and ► Solutions
PARKTRONIC Inoperative See Operator's Manual	<ul style="list-style-type: none"> * Parking Assist PARKTRONIC is malfunctioning. Once the cause of the problem is no longer present, the system will be available again. <ul style="list-style-type: none"> ► Continue driving while paying attention to the vehicle's surroundings. or ► Stop the vehicle in accordance with the traffic conditions and restart the vehicle. ► If the display message still appears, consult a qualified specialist workshop.
Active Parking Assist and PARKTRONIC Inoperative See Operator's Manual	<ul style="list-style-type: none"> * Active Parking Assist and Parking Assist PARKTRONIC are malfunctioning. Once the cause of the problem is no longer present, the system will be available again. <ul style="list-style-type: none"> ► Continue driving while paying attention to the vehicle's surroundings. or ► Stop the vehicle in accordance with the traffic conditions and restart the vehicle. ► If the display message still appears, consult a qualified specialist workshop.



Mercedes-Benz emergency call system

Display messages	Possible causes/consequences and ► Solutions
 <p>Inoperative</p>	<p>* The Mercedes-Benz emergency call system is malfunctioning. The Mercedes me connect system is also malfunctioning.</p> <ul style="list-style-type: none">► Consult a qualified specialist workshop.

Battery

Display messages	Possible causes/consequences and ► Solutions
 <p>12 V On-board Electrical System Service Required</p>	<p>* The 12 V on-board electrical system is malfunctioning.</p> <ul style="list-style-type: none">► Consult a qualified specialist workshop immediately.

Display messages	Possible causes/consequences and ► Solutions
 <p data-bbox="194 341 443 393">Stop Vehicle See Operator's Manual</p>	<p data-bbox="526 248 1312 274">* The 12 V battery is no longer being charged and the state of charge is too low.</p> <div data-bbox="545 290 1690 409" style="border: 1px solid black; padding: 5px;"> <p data-bbox="554 300 1127 326">! NOTE Possible engine damage if you continue driving</p> <ul style="list-style-type: none"> <li data-bbox="563 336 1081 367">▶ Do not continue driving under any circumstances. <li data-bbox="563 372 988 404">▶ Consult a qualified specialist workshop. </div> <ul style="list-style-type: none"> <li data-bbox="545 424 1506 455">▶ Stop the vehicle immediately in accordance with the traffic conditions. Do not continue driving. <li data-bbox="545 461 803 492">▶ Switch off the vehicle. <li data-bbox="545 497 970 528">▶ Consult a qualified specialist workshop.
 <p data-bbox="194 631 443 683">Switch on vehicle to charge the 12 V battery</p>	<p data-bbox="526 538 1238 564">* The vehicle is off and the state of charge of the 12 V battery is too low.</p> <ul style="list-style-type: none"> <li data-bbox="545 569 1099 600">▶ Switch off electrical consumers that are not required. <li data-bbox="545 606 803 637">▶ Drive for 30–60 mins. <p data-bbox="545 642 572 663">or</p> <ul style="list-style-type: none"> <li data-bbox="545 668 1136 699">▶ Charge the 12 V battery when stationary (→ page 311).



Display messages	Possible causes/consequences and ► Solutions
 <p data-bbox="144 339 421 418">Stop Vehicle To Charge the 12 V Battery Do Not Switch Off Vehicle</p>	<ul style="list-style-type: none"> <li data-bbox="473 249 975 272">* The state of charge of the 12 V battery is too low. <li data-bbox="495 280 1452 308">► Stop the vehicle immediately in accordance with the traffic conditions. Do not continue driving. <li data-bbox="495 317 778 344">► Leave the vehicle running <li data-bbox="495 353 953 381">► If the display message disappears: drive on. <li data-bbox="495 389 1332 417">► If the display message does not disappear: consult a qualified specialist workshop.
 <p data-bbox="144 533 402 612">Battery Overheated Stop! Everyone Get Out! Outdoors if Possible</p>	<ul style="list-style-type: none"> <li data-bbox="473 443 1018 471">* The 48 V battery is overheating. There is a risk of fire. <li data-bbox="495 479 1215 507">► Stop the vehicle immediately in accordance with the traffic conditions. <li data-bbox="495 515 1387 543">► If possible, stop the vehicle in the open air and ensure that all vehicle occupants get out. <li data-bbox="495 552 1600 580">ⓘ Supporting vehicle functions may activate automatically, e.g. air-recirculation mode as part of climate control. <li data-bbox="495 588 765 616">► Do not continue driving. <li data-bbox="495 624 1300 652">► If smoke is present, leave the danger zone and call the fire service immediately. <li data-bbox="495 660 1332 688">► Consult a qualified specialist workshop even if there are no external signs of a fire.
 <p data-bbox="144 788 389 840">48 V Battery See Operator's Manual</p>	<ul style="list-style-type: none"> <li data-bbox="473 698 1092 726">* The 48 V on-board electrical system has function restrictions. <li data-bbox="495 734 1434 762">Comfort functions, such as the air conditioning system, may be available only to a limited extent. <li data-bbox="495 770 731 798">It is possible to drive on. <li data-bbox="495 807 1535 835">► If the display message remains active permanently, consult a qualified specialist workshop immediately.

Display messages	Possible causes/consequences and ► Solutions
 <p data-bbox="194 341 462 393">Please Wait Charging 48 V Battery...</p>	<p data-bbox="526 248 1690 300">* The 48 V battery is discharged. You have switched on the vehicle while the 12 V battery was being charged with a suitable charger or while another vehicle was providing starting assistance.</p> <p data-bbox="545 310 1690 362">The discharged 48 V battery is charged automatically via the voltage converter. After a few minutes, the Starting Possible Again display message will be shown on the driver's display.</p> <ul style="list-style-type: none"> <li data-bbox="545 372 748 398">► Start the vehicle. <li data-bbox="545 409 1690 461">► Drive the vehicle for a while to charge the 12 V battery and the 48 V battery after disconnecting the charger from the vehicle. <p data-bbox="545 481 1358 507">If the Starting Possible Again display message does not appear after a few minutes:</p> <ul style="list-style-type: none"> <li data-bbox="545 518 803 543">► Try to start the vehicle. <li data-bbox="545 554 1247 580">► If the vehicle does not start, consult a qualified specialist workshop.
<p data-bbox="194 595 434 621">Starting Possible Again</p>	<p data-bbox="526 595 1275 621">* The 48 V battery has been charged automatically via the voltage converter.</p> <ul style="list-style-type: none"> <li data-bbox="545 626 1413 652">► Start the vehicle and drive for a while to charge the 12 V battery and the 48 V battery.

Tire pressure monitor

Display messages	Possible causes/consequences and ► Solutions
<p data-bbox="194 797 462 849">Tire Pressure Monitor Currently Unavailable</p>	<p data-bbox="526 797 1690 849">* There is interference from a powerful radio signal source As a result, no signals from the tire pressure sensors are being received. The tire pressure monitoring system is temporarily unavailable.</p> <p data-bbox="545 859 1543 885">The tire pressure monitoring system will restart automatically as soon as the cause has been rectified.</p>

410 Display messages and warning/indicator lamps

Display messages	Possible causes/consequences and ► Solutions
	<ul style="list-style-type: none"> ► Drive on
<p>Tire Pressure Monitor Inoperative</p>	<ul style="list-style-type: none"> * The tire pressure monitoring system is malfunctioning. <div data-bbox="495 332 1648 484" style="border: 1px solid gray; padding: 5px; margin-top: 10px;"> <p>⚠ WARNING There is a risk of an accident if the tire pressure monitoring system is malfunctioning</p> <p>The tire pressure monitoring system cannot issue a warning if there is pressure loss in one or more of the tires. Tires with insufficient tire pressure may impair the driving characteristics as well as steering and braking.</p> <ul style="list-style-type: none"> ► Have the tire pressure monitoring system checked at a qualified specialist workshop. </div>
<p>Tire Pressure Monitor Inoperative Tire Pressure Sensors Missing</p>	<ul style="list-style-type: none"> * The wheels installed do not have suitable tire pressure sensors. The tire pressure monitoring system is deactivated. <ul style="list-style-type: none"> ► Install wheels with suitable tire pressure sensors.
<div data-bbox="155 601 312 684" style="border: 1px solid black; text-align: center; width: 85px; height: 80px; margin-bottom: 5px;">  </div> <p>Wheel Sensor(s) Missing</p>	<ul style="list-style-type: none"> * There is no signal from the tire pressure sensor in at least one wheel. No pressure value is displayed for the affected tire. <ul style="list-style-type: none"> ► Have the faulty tire pressure sensor replaced at a qualified specialist workshop.
<div data-bbox="155 743 312 826" style="border: 1px solid black; text-align: center; width: 85px; height: 80px; margin-bottom: 5px;">  </div> <p>Check Tires</p>	<ul style="list-style-type: none"> * The tire pressure in one or more tires has dropped significantly. The wheel position is displayed. A warning tone also sounds.

Display messages	Possible causes/consequences and ► Solutions
	<div data-bbox="550 249 1696 512" style="border: 1px solid gray; padding: 5px;"> <p>▲ WARNING Risk of an accident due to insufficient tire pressure</p> <ul style="list-style-type: none"> • The tires can burst. • The tires can wear excessively and/or unevenly. • The driving characteristics as well as the steering and braking may be greatly impaired. <p>You could then lose control of the vehicle.</p> <ul style="list-style-type: none"> ► Observe the recommended tire pressures. ► Adjust the tire pressure if necessary. </div> <p>► Stop the vehicle in accordance with the traffic conditions.</p> <p>► Check the tire pressure (→ page 322) and the tires.</p>
<div data-bbox="205 607 362 689" style="border: 1px solid black; text-align: center; width: 60px; height: 60px; margin: 0 auto;">  </div> <p data-bbox="195 700 445 746">Please Correct Tire Pressure</p>	<p>* The tire pressure is too low in at least one of the tires, or the difference in tire pressure between the individual wheels is too great.</p> <ul style="list-style-type: none"> ► Check the tire pressure and add air, if necessary. ► When the tire pressure is correct, restart the tire pressure monitor (→ page 327).



Display messages	Possible causes/consequences and ► Solutions
<div data-bbox="155 249 314 332" data-label="Image"> </div> <div data-bbox="144 339 399 365" data-label="Caption"> <p>Warning Tire Malfunction</p> </div>	<p>* The pressure in one or more tires has dropped suddenly. The wheel position is displayed.</p> <div data-bbox="500 291 1646 332" data-label="Text"> <p>▲ WARNING Risk of an accident from driving with a flat tire</p> </div> <ul data-bbox="513 339 1544 399" style="list-style-type: none"> • The tires can overheat and be damaged. • The driving characteristics as well as the steering and braking characteristics may be greatly impaired. <p data-bbox="513 415 924 441">You could then lose control of the vehicle.</p> <ul data-bbox="513 446 1604 570" style="list-style-type: none"> ► Do not drive with a flat tire. ► Do not exceed the maximum permissible driving distance in emergency mode and the maximum permissible speed with a flat MOExtended tire. ► Observe the notes on flat tires. <p data-bbox="495 596 813 622">Notes on flat tire (→ page 301).</p> <ul data-bbox="495 627 1092 689" style="list-style-type: none"> ► Stop the vehicle in accordance with the traffic conditions. ► Check the tires.
<div data-bbox="155 710 314 793" data-label="Image"> </div> <div data-bbox="144 800 319 826" data-label="Caption"> <p>Tires Overheated</p> </div>	<p>* At least one tire is overheating. The affected tires are displayed in red. At temperatures close to the limit value, the tires are displayed in yellow.</p> <div data-bbox="500 778 1646 819" data-label="Text"> <p>▲ WARNING Risk of an accident from driving with overheated tires</p> </div> <p data-bbox="513 824 781 850">Overheated tires can burst.</p>



Display messages	Possible causes/consequences and ► Solutions
 <p data-bbox="195 399 343 422">Reduce Speed</p>	<p data-bbox="561 252 1696 291">► Reduce speed so that the tires cool down.</p> <p data-bbox="528 308 1659 358">* At least one tire is overheating. The affected tires are displayed in red. At temperatures close to the limit value, the tires are displayed in yellow.</p> <p data-bbox="556 377 1696 415">▲ WARNING Risk of an accident from driving with overheated tires</p> <p data-bbox="561 425 1696 449">Overheated tires can burst.</p> <p data-bbox="561 456 1696 480">► Reduce speed so that the tires cool down.</p>

Engine oil

Display messages	Possible causes/consequences and ► Solutions
 <p data-bbox="195 731 454 806">Check Engine Oil Level At Next Refueling (Add 1 Quart)</p>	<p data-bbox="528 640 1073 664">* The engine oil level has dropped to the minimum level.</p> <p data-bbox="556 684 1696 723">! NOTE Engine damage caused by driving with insufficient engine oil</p> <p data-bbox="561 731 1696 765">► Avoid long journeys with insufficient engine oil.</p> <p data-bbox="543 781 1245 809">► When next refueling, add 1.1 US qt (1 l) of engine oil (→ page 286).</p> <p data-bbox="543 824 888 852">Notes on engine oil (→ page 359).</p>

414 Display messages and warning/indicator lamps

Display messages	Possible causes/consequences and ► Solutions
 <p>Engine Oil Level Reduce Oil Level</p>	<p>* The engine oil level is too high.</p> <div data-bbox="500 291 1646 335"><p>! NOTE Engine damage caused by driving with excess engine oil</p></div> <div data-bbox="500 338 1646 377"><p>► Avoid long journeys with excess engine oil.</p></div> <p>► Consult a qualified specialist workshop immediately and have the engine oil level reduced.</p>
 <p>Engine Oil Level Stop Switch Off Vehicle</p>	<p>* The engine oil level is too low.</p> <div data-bbox="500 477 1646 522"><p>! NOTE Engine damage caused by driving with insufficient engine oil</p></div> <div data-bbox="500 525 1646 563"><p>► Avoid long journeys with insufficient engine oil.</p></div> <p>► Stop the vehicle immediately in accordance with the traffic conditions. Do not continue driving.</p> <p>► Switch off the vehicle.</p> <p>► Add 1.1 US qt (1 l) of engine oil (→ page 286).</p> <p>► Check the engine oil level.</p> <p>Notes on engine oil (→ page 359).</p>

Display messages	Possible causes/consequences and ► Solutions
 <p data-bbox="197 342 445 391">Engine Oil Pressure Stop Switch Off Vehicle</p>	<p data-bbox="524 249 805 273">* The oil pressure is too low.</p> <div data-bbox="550 291 1696 377" style="border: 1px solid black; padding: 5px;"> <p data-bbox="559 301 1271 327">! NOTE Engine damage caused by driving with insufficient oil pressure</p> <p data-bbox="559 339 1009 365">► Avoid driving with insufficient oil pressure.</p> </div> <ul data-bbox="543 391 1507 487" style="list-style-type: none"> <li data-bbox="543 391 1507 420">► Stop the vehicle immediately in accordance with the traffic conditions. Do not continue driving. <li data-bbox="543 425 796 454">► Switch off the vehicle. <li data-bbox="543 459 966 487">► Consult a qualified specialist workshop.
 <p data-bbox="197 598 467 647">Engine Oil Level Cannot Be Measured</p>	<p data-bbox="524 505 1513 529">* The electrical connection to the oil level sensor has been interrupted or the oil level sensor is faulty.</p> <ul data-bbox="543 539 966 563" style="list-style-type: none"> <li data-bbox="543 539 966 563">► Consult a qualified specialist workshop.

Warning and indicator lamps

Overview of indicator and warning lamps

Some systems will perform a self-test when the vehicle is switched on. Some indicator and warning lamps may briefly light up or flash. This behav-

ior is non-critical. These indicator and warning lamps indicate a malfunction only if they light up or flash after the vehicle has been started or during a journey.

The indicator and warning lamps are located in the highlighted display sections.

Standard driver display







Widescreen cockpit driver display



Indicator and warning lamps



Occupant safety

-  Restraint system (→ page 418)
-  Seat belt (→ page 418)
-  Occupant presence reminder (white) (→ page 418)
-  Occupant presence reminder (yellow) (→ page 418)



Drive system



-  Reduced power (→ page 420)

Vehicle







-  Power steering (yellow) (→ page 420)
-  Power steering (red) (→ page 420)

Engine





-  Vehicles with widescreen cockpit: coolant temperature (→ page 421)
-  Engine diagnostics (→ page 421)
-  Vehicles with gasoline engine: engine operating temperature (→ page 421)

-  Electrical malfunction (→ page 421)
-  Reserve fuel with fuel filler flap location indicator (→ page 421)

Brakes

-  Electric parking brake (yellow) (→ page 425)
-  USA: electric parking brake (red) (→ page 425)
-  Canada: electric parking brake (red) (→ page 425)
-  USA: Recuperative Brake System (→ page 425)
-  Canada: brakes (yellow)(→ page 425)
-  USA: brakes (red) (→ page 425)
-  Canada: brakes (red) (→ page 425)

Driving and driving safety systems

-  ABS (→ page 428)
-  ESP® (→ page 428)
-  ESP® OFF (→ page 428)
-  ATTENTION ASSIST (→ page 428)



Traffic Sign Assist (→ page 428)



Close-range braking (→ page 225)



Distance warning (→ page 428)



Active Brake Assist (→ page 428)



Active Brake Assist (→ page 428)

Mercedes-Benz emergency call system



Mercedes-Benz emergency call system
(→ page 431)

Tire pressure monitor



Tire pressure monitor(→ page 432)

Exterior lighting



Side lights (→ page 125)



Low beam (→ page 125)



High beam (→ page 126)



Turn signal lights (→ page 126)



Rear fog light (→ page 125)

Symbols on the central display







Drive Away Assist (→ page 223)



Cross Traffic Alert (→ page 224)

Occupant safety



Warning/indicator lamp	Possible causes/consequences and ► Solutions
 <p>Restraint system warning lamp</p>	<p>* The restraint system red warning lamp is lit while the vehicle is on. The restraint system is malfunctioning (→ page 44).</p> <div style="border: 1px solid gray; padding: 5px; margin: 10px 0;"> <p>▲ WARNING Risk of injury due to malfunctions in the restraint system</p> <p>Components in the restraint system may be activated unintentionally or not deploy as planned in an accident.</p> <p>► Have the restraint system checked and repaired immediately at a qualified specialist workshop.</p> </div> <ul style="list-style-type: none"> ► Drive on carefully. ► Note the messages on the driver display. ► Consult a qualified specialist workshop immediately.
 <p>Seat belt warning lamp flashes</p>	<p>* The red seat belt warning lamp flashes and an intermittent warning tone sounds. The driver or front passenger has not fastened his/her seat belt while the vehicle is in motion.</p> <ul style="list-style-type: none"> ► Fasten your seat belt (→ page 44). ► There are objects on the front passenger seat. ► Remove the objects from the front passenger seat.

Warning/indicator lamp	Possible causes/consequences and ► Solutions
 <p data-bbox="195 342 426 394">Seat belt warning lamp lights up</p>	<p data-bbox="513 249 1360 275">* The red seat belt warning lamp lights up for six seconds once the vehicle has started.</p> <p data-bbox="528 283 1040 309">In addition, an intermittent warning tone may sound.</p> <p data-bbox="528 311 1461 337">The red seat belt warning lamp reminds the driver and front passenger to fasten their seat belts.</p> <p data-bbox="528 342 907 368">► Fasten your seat belt (→ page 44).</p> <p data-bbox="528 387 1517 413">If you have placed objects on the front passenger seat, the red seat belt warning lamp may remain lit.</p>
 <p data-bbox="195 521 426 598">Occupant presence reminder warning lamp (white)</p>	<p data-bbox="513 427 1101 453">* The white occupant presence reminder warning lamp is lit.</p> <p data-bbox="528 455 999 481">The occupant presence reminder is deactivated.</p> <p data-bbox="528 486 1169 512">► Switch on the occupant presence reminder, see (→ page 73).</p>
 <p data-bbox="195 707 473 785">Occupant presence reminder warning lamp (yellow)</p>	<p data-bbox="513 614 1110 640">* The yellow occupant presence reminder warning lamp is lit.</p> <p data-bbox="528 642 1027 668">The occupant presence reminder is malfunctioning</p> <p data-bbox="528 673 962 699">► Note the messages on the driver display.</p>

Drive system

Warning/indicator lamp	Possible causes/consequences and ► Solutions
 <p data-bbox="144 384 371 433">Reduced warning lamp power</p>	<p data-bbox="458 291 931 342">* The yellow reduced-power warning lamp is on. Drive system power output is reduced.</p> <p data-bbox="476 350 911 377">► Note the messages on the driver display.</p>

Vehicle



Warning/indicator lamp	Possible causes/consequences and ► Solutions
 <p data-bbox="144 671 376 723">Power steering warning lamp (yellow)</p>	<p data-bbox="458 578 1190 629">* The yellow power steering warning lamp is lit while the vehicle is running. The power assistance or the steering itself is malfunctioning.</p> <p data-bbox="476 637 911 664">► Note the messages on the driver display.</p>
 <p data-bbox="144 829 376 881">Power steering warning lamp (red)</p>	<p data-bbox="458 736 1162 788">* The red power steering warning lamp is lit while the vehicle is running. The power assistance or the steering itself is malfunctioning.</p>



Warning/indicator lamp	Possible causes/consequences and ► Solutions
	<p>▲ WARNING Risk of accident if steering capability is impaired</p> <p>If the steering does not function as intended, the vehicle's operating safety is jeopardized.</p> <ul style="list-style-type: none"> ▶ Pull over and stop the vehicle safely as soon as possible, paying attention to road and traffic conditions. Do not continue driving under any circumstances. ▶ Consult a qualified specialist workshop. <p>► Note the messages on the driver display.</p>

Engine

Warning/indicator lamp	Possible causes/consequences and ► Solutions
 <p>Coolant warning lamp (red)</p>	<p>* The red coolant warning lamp is lit while the engine is running.</p> <p>Possible causes:</p> <ul style="list-style-type: none"> • The temperature sensor is malfunctioning • The coolant level is too low • The air supply to the radiator is obstructed • The radiator fan is faulty • The engine coolant pump is faulty

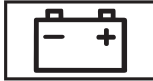



Warning/indicator lamp	Possible causes/consequences and ► Solutions
	<p>If there is an additional warning tone, the coolant temperature has exceeded the maximum permissible temperature.</p> <p>▲ WARNING Risk of burns when opening the hood</p> <p>If you open the hood in the event of an overheated engine or fire in the engine compartment, the following situations may occur:</p> <ul style="list-style-type: none">• You may come into contact with hot gases.• You may come into contact with other escaping hot operating fluids. <p>► Before opening the hood, allow the engine to cool down.</p> <p>► In the event of a fire in the engine compartment, keep the hood closed and call the fire service.</p> <p>► Stop immediately in accordance with the traffic conditions and switch off the vehicle. Do not continue driving.</p> <p>► Note the messages on the driver display.</p> <p>If the coolant temperature display is at the lower end of the temperature scale:</p> <p>► Consult a qualified specialist workshop.</p> <p>If the coolant temperature display is at the upper end of the temperature scale:</p> <p>► Exit the vehicle and keep a safe distance from it until the engine has cooled down.</p> <p>► Check the coolant level (→ page 287).</p> <p>► Make sure that the air supply to the radiator is not obstructed.</p>

Warning/indicator lamp	Possible causes/consequences and ► Solutions
 <p data-bbox="194 409 462 461">Coolant warning lamp (yellow)</p>	<p data-bbox="526 248 1663 300">► Avoiding high loads on the engine, drive to the nearest qualified specialist workshop. In doing so, ensure that the coolant temperature display remains below the red area.</p> <p data-bbox="526 315 1164 341">* The yellow coolant warning lamp is lit while the engine is running.</p> <p data-bbox="526 352 693 378">Possible causes:</p> <ul data-bbox="535 388 1127 481" style="list-style-type: none"> • The temperature sensor is malfunctioning • The charge air, transmission oil or battery cooling is faulty • The radiator shutters are blocked or defective <p data-bbox="526 497 1386 523">► Avoiding high loads on the engine, drive to the nearest qualified specialist workshop.</p>
 <p data-bbox="194 631 462 657">Check Engine warning lamp</p>	<p data-bbox="526 538 1681 590">* The yellow engine diagnostics warning lamp is lit while the engine is running. A malfunction has occurred in the engine, the exhaust system or the fuel system.</p> <p data-bbox="526 600 1506 626">This may cause the emissions limit values to be exceeded and the engine to run in emergency mode.</p> <p data-bbox="526 637 1681 688">In some states, legal requirements stipulate that you must immediately consult a qualified specialist workshop as soon as the yellow engine diagnostics warning lamp lights up.</p> <p data-bbox="526 699 1339 725">► Have the vehicle checked as soon as possible at a qualified specialist workshop.</p>
 <p data-bbox="194 828 462 880">Electrical malfunction warning lamp</p>	<p data-bbox="526 735 1007 787">* The red electrical malfunction warning lamp is lit. There is a malfunction in the electrics.</p> <p data-bbox="526 797 960 823">► Note the messages on the driver display.</p>

Warning/indicator lamp	Possible causes/consequences and ► Solutions
 <p data-bbox="144 342 408 391">Engine operating temperature warning lamp</p>	<p data-bbox="463 249 1535 298">* Vehicles with gasoline engines: after a cold start, the blue engine operating temperature warning lamp is on. Engine output and engine torque are reduced.</p> <ul style="list-style-type: none"> <li data-bbox="476 308 981 332">► Take this into consideration in your driving style.
 <p data-bbox="144 504 408 553">Fuel reserve warning lamp flashes</p>	<p data-bbox="463 411 1628 459">* The yellow fuel reserve warning lamp lights up while you are driving. There has been pressure loss in the fuel system. The fuel filler cap is not closed correctly or the fuel system is leaking.</p> <ul style="list-style-type: none"> <li data-bbox="476 470 746 494">► Close the fuel filler cap. <p data-bbox="476 522 999 545">If the fuel filler cap has already been closed correctly:</p> <ul style="list-style-type: none"> <li data-bbox="476 556 898 580">► Consult a qualified specialist workshop.
 <p data-bbox="144 691 408 739">Fuel reserve warning lamp lights up</p>	<p data-bbox="463 597 1197 646">* The yellow fuel reserve warning lamp lights up while the engine is running. The fuel supply has dropped into the reserve range.</p> <ul style="list-style-type: none"> <li data-bbox="476 656 580 680">► Refuel.



Brakes



Warning/indicator lamp	Possible causes/consequences and ► Solutions
<div data-bbox="205 296 362 379" data-label="Image"> </div> <p data-bbox="195 387 463 436">Electric parking brake indicator lamp (red) (USA only)</p> <div data-bbox="205 443 362 526" data-label="Image"> </div> <p data-bbox="195 534 463 609">Electric parking brake indicator lamp (red) (Canada only)</p> <div data-bbox="205 616 362 699" data-label="Image"> </div> <p data-bbox="195 707 463 756">Electric parking brake indicator lamp (yellow)</p>	<p data-bbox="513 294 1119 319">* The red electric parking brake indicator lamp flashes or is lit.</p> <p data-bbox="526 327 1406 352">The yellow electric parking brake indicator lamp is also lit up in the event of a malfunction.</p> <ul data-bbox="526 356 962 381" style="list-style-type: none"> <li data-bbox="526 356 962 381">► Note the messages on the driver display.



Warning/indicator lamp	Possible causes/consequences and ► Solutions
 <p>RBS warning lamp (USA only)</p>  <p>Brakes warning lamp (yellow) (Canada only)</p>	<p>*The yellow  warning lamp (USA only) or the yellow  brake warning lamp (Canada only) is lit while the vehicle is running.</p> <p>▲ WARNING Risk of an accident due to a brake system malfunction</p> <p>If the brake system is malfunctioning, braking characteristics may be impaired.</p> <ul style="list-style-type: none">▶ Drive on carefully.▶ Have the brake system checked immediately at a qualified specialist workshop. <p>▶ Adjust your speed and drive on carefully, leaving a suitable distance to the vehicle in front.</p> <p>▶ If the driver's display shows a display message, observe it.</p> <p>▶ Consult a qualified specialist workshop.</p>



Warning/indicator lamp	Possible causes/consequences and ► Solutions
<div data-bbox="203 253 360 331" data-label="Image"> </div> <p data-bbox="194 341 462 393">Brakes warning lamp (USA only)</p> <div data-bbox="203 398 360 476" data-label="Image"> </div> <p data-bbox="194 486 462 538">Brakes warning lamp (Canada only)</p>	<p data-bbox="508 248 1136 274">* The red brakes warning lamp is lit while the vehicle is running.</p> <p data-bbox="526 284 693 310">Possible causes:</p> <ul data-bbox="526 321 1459 378" style="list-style-type: none"> • The brake force boosting is malfunctioning and the braking characteristics may be affected. • There is insufficient brake fluid in the brake fluid reservoir. <p data-bbox="526 393 960 419">► Note the messages on the driver display.</p> <div data-bbox="526 440 1700 481" data-label="Section-Header"> <p>▲ WARNING Risk of accident and injury if brake force boosting is malfunctioning</p> </div> <p data-bbox="545 486 1644 538">If brake force boosting is malfunctioning, increased brake pedal force may be necessary for braking. The braking characteristics may be impaired. The braking distance can increase in emergency braking situations.</p> <ul data-bbox="545 549 1173 606" style="list-style-type: none"> ► Stop in a safe location immediately. Do not continue driving. ► Consult a qualified specialist workshop. <div data-bbox="526 637 1700 678" data-label="Section-Header"> <p>▲ WARNING Risk of an accident due to low brake fluid level</p> </div> <p data-bbox="545 683 1524 709">If the brake fluid level is too low, the braking effect and the braking characteristics may be impaired.</p> <ul data-bbox="545 720 1663 839" style="list-style-type: none"> ► Pull over and stop the vehicle safely as soon as possible, paying attention to road and traffic conditions. Do not continue driving under any circumstances. ► Consult a qualified specialist workshop. ► Do not add brake fluid.

Driving and driving safety systems

Warning/indicator lamp	Possible causes/consequences and ► Solutions
 <p data-bbox="144 384 323 410">ABS warning lamp</p>	<p data-bbox="462 291 1084 342">* The yellow ABS warning lamp is lit while the vehicle is running. ABS is malfunctioning.</p> <p data-bbox="476 353 1060 379">If an additional warning tone sounds, EBD is malfunctioning.</p> <p data-bbox="476 386 1230 412">Other driving systems and driving safety systems may also be malfunctioning.</p> <p data-bbox="476 419 909 445">► Note the messages on the driver display.</p> <div data-bbox="482 464 1648 676" style="border: 1px solid black; padding: 5px;"> <p data-bbox="491 472 1203 498">▲ WARNING There is a risk of skidding if EBD or ABS is malfunctioning</p> <p data-bbox="491 513 851 539">The wheels may lock during braking.</p> <p data-bbox="491 547 1618 598">The steerability and braking characteristics are heavily impaired and the braking distance may increase. In addition, other driving safety systems are switched off.</p> <ul style="list-style-type: none"> <li data-bbox="491 607 707 632">► Drive on carefully. <li data-bbox="491 640 1299 666">► Have the brake system checked immediately at a qualified specialist workshop. </div>
 <p data-bbox="144 785 412 811">ESP® warning lamp flashes</p>	<p data-bbox="462 692 1143 743">* The yellow ESP® warning lamp flashes while the vehicle is in motion. One or more wheels have reached their grip limit (→ page 175).</p> <p data-bbox="476 752 1136 778">► Adapt your driving style to suit the road and weather conditions.</p>

Warning/indicator lamp	Possible causes/consequences and ► Solutions
 <p data-bbox="194 341 480 367">ESP® warning lamp lights up</p>	<p data-bbox="508 248 1145 305">* The yellow ESP® warning lamp is lit while the vehicle is running. ESP® is malfunctioning.</p> <p data-bbox="526 315 1386 341">Other driving systems and driving safety systems (e.g. BAS) may also be malfunctioning.</p> <p data-bbox="526 347 960 372">► Note the messages on the driver display.</p> <div data-bbox="526 388 1690 574" style="border: 1px solid gray; padding: 5px;"> <p data-bbox="535 398 1099 429">▲ WARNING Risk of skidding if ESP® is malfunctioning</p> <p data-bbox="545 440 1653 492">If ESP® is malfunctioning, ESP® cannot carry out vehicle stabilization. In addition, other driving safety systems are switched off.</p> <ul style="list-style-type: none"> <li data-bbox="545 502 757 528">► Drive on carefully. <li data-bbox="545 538 1118 564">► Have ESP® checked at a qualified specialist workshop. </div>
 <p data-bbox="194 683 434 709">ESP® OFF warning lamp</p>	<p data-bbox="508 590 1191 647">* The yellow ESP® OFF warning lamp is lit while the vehicle is running. ESP® is deactivated.</p> <p data-bbox="526 657 1247 683">Other driving systems and driving safety systems may also be inoperative.</p> <div data-bbox="526 699 1690 849" style="border: 1px solid gray; padding: 5px;"> <p data-bbox="535 709 1201 740">▲ WARNING Risk of skidding when driving with ESP® deactivated</p> <p data-bbox="545 751 1561 777">ESP® does not act to stabilize the vehicle. The availability of further driving safety systems is also limited.</p> <ul style="list-style-type: none"> <li data-bbox="545 787 757 813">► Drive on carefully. <li data-bbox="545 823 1145 849">► Deactivate ESP® only for as long as the situation requires. </div>



Warning/indicator lamp	Possible causes/consequences and ► Solutions
	<p>If ESP® cannot be activated, ESP® is malfunctioning.</p> <ul style="list-style-type: none"> ► Have ESP® checked immediately at a qualified specialist workshop. ► Observe the notes on deactivating ESP® (→ page 175).
 <p>ATTENTION ASSIST warning lamp</p>	<p>* The ATTENTION ASSIST warning lamp is lit. ATTENTION ASSIST is malfunctioning.</p> <ul style="list-style-type: none"> ► Consult a qualified specialist workshop.
 <p>Traffic Sign Assist warning lamp</p>	<p>* The Traffic Sign Assist warning lamp is lit. Traffic Sign Assist is malfunctioning.</p> <ul style="list-style-type: none"> ► Note the messages on the driver display.
 <p>Distance warning lamp</p>	<p>* The red distance warning lamp lights up while the vehicle is in motion. The distance to the vehicle in front is too small for the speed selected. If there is an additional warning tone, you are approaching an obstacle at too high a speed.</p> <ul style="list-style-type: none"> ► Be prepared to brake immediately. ► Increase the distance.

Warning/indicator lamp	Possible causes/consequences and ► Solutions
 <p data-bbox="194 383 471 435">Active Brake Assist warning lamp</p>	<p data-bbox="526 248 979 274">Function of Active Brake Assist (→ page 194).</p> <p data-bbox="508 290 1533 341">* The Active Brake Assist warning lamp is on. Due to dirty sensors or a malfunction, the system is not available or the range of functions is restricted.</p> <ul style="list-style-type: none"> <li data-bbox="526 352 960 378">► Note the messages on the driver display.
 <p data-bbox="194 543 471 595">Active Brake Assist warning lamp</p>	<p data-bbox="508 450 1367 533">* The Active Brake Assist warning lamp is on. The system is switched off or the range of functions has been automatically restricted. This may be the case if another driving system has been activated.</p> <ul style="list-style-type: none"> <li data-bbox="526 543 1118 569">► Observe the notes on Active Brake Assist (→ page 194).

Mercedes-Benz emergency call system

Warning/indicator lamp	Possible causes/consequences and ► Solutions
 <p data-bbox="194 833 471 885">Mercedes-Benz emergency call system warning lamp</p>	<p data-bbox="517 740 1690 766">*The Mercedes-Benz emergency call system is malfunctioning. The Mercedes me connect system is also malfunctioning.</p> <ul style="list-style-type: none"> <li data-bbox="526 766 951 792">► Consult a qualified specialist workshop.

Tire pressure monitor

Warning/indicator lamp	Possible causes/consequences and ► Solutions
 <p data-bbox="144 412 428 458">Tire pressure monitoring system warning lamp flashes</p>	<p data-bbox="467 319 1613 394">*The yellow tire pressure monitor warning lamp (pressure loss/malfunction) flashes for approximately one minute and then remains lit. The tire pressure monitoring system is malfunctioning.</p> <div data-bbox="482 412 1646 562" style="border: 1px solid gray; padding: 5px;"> <p data-bbox="491 420 1467 446">▲ WARNING There is a risk of an accident if the tire pressure monitoring system is malfunctioning</p> <p data-bbox="495 459 1572 519">The tire pressure monitoring system cannot issue a warning if there is pressure loss in one or more of the tires. Tires with insufficient tire pressure may impair the driving characteristics as well as steering and braking.</p> <p data-bbox="495 529 1354 555">► Have the tire pressure monitoring system checked at a qualified specialist workshop.</p> </div>
 <p data-bbox="144 674 413 750">Tire pressure monitoring system warning lamp lights up</p>	<p data-bbox="467 581 1360 629">*The yellow tire pressure monitoring system warning lamp (pressure loss/malfunction) is lit. The tire pressure monitoring system has detected a loss of pressure in at least one tire.</p> <div data-bbox="482 647 1646 873" style="border: 1px solid gray; padding: 5px;"> <p data-bbox="491 655 1138 681">▲ WARNING Risk of an accident due to insufficient tire pressure</p> <ul data-bbox="500 695 1373 790" style="list-style-type: none"> • The tires can burst. • The tires can wear excessively and/or unevenly. • The driving characteristics as well as the steering and braking may be greatly impaired. <p data-bbox="495 809 903 829">You could then lose control of the vehicle.</p> <p data-bbox="495 840 944 866">► Observe the recommended tire pressures.</p> </div>

Warning/indicator lamp	Possible causes/consequences and ► Solutions
	<ul style="list-style-type: none"><li data-bbox="526 253 1696 290">▶ Adjust the tire pressure if necessary.<li data-bbox="526 305 1696 336">▶ Stop the vehicle in accordance with the traffic conditions.<li data-bbox="526 341 1696 367">▶ Check the tire pressure and the tires.

1, 2, 3 ...

(SmartKey) battery.....	76
4MATIC.....	161
48 V on-board electrical system	
Displays in the driver's display.....	232
Operating safety.....	27

A

A/C function

Activating/deactivating (MBUX).....	138
Activating/deactivating (operating unit).....	138

ABS.....	174
----------	-----

Acceleration

Kickdown.....	160
---------------	-----

Accident, emergency call.....	271
-------------------------------	-----

Activating/deactivating the acoustic locking verification signal.....	75
---	----

Active Brake Assist

Function.....	194
Setting.....	198

Active Distance Assist DISTRONIC

Activating/deactivating.....	186
Active Emergency Stop Assist.....	192
Active Speed Limit Assist.....	188
Calling up a speed.....	186
Function.....	183
Increasing/decreasing the speed.....	186
Route-based speed adaptation.....	188
Storing a speed.....	186

Active Emergency Stop Assist.....	192
-----------------------------------	-----

Active headlamps.....	128
-----------------------	-----

Active Lane Keeping Assist

Activating/deactivating.....	206
Function.....	204
Setting the sensitivity.....	206

Active light function.....	128
----------------------------	-----

Active Parking Assist

Automatic braking function.....	223
Exiting a parking space.....	222
Function.....	218
Maneuvering brake function.....	225
Parking.....	220
Pausing.....	223

Active Service System PLUS.....	281
---------------------------------	-----

Active Speed Limit Assist.....	188
--------------------------------	-----

Active Steering Assist

Activating/deactivating.....	192
Active Emergency Stop Assist.....	192
Function.....	190

Adaptive cruise control.....	188
------------------------------	-----

Adaptive damping system

Suspension.....	206
-----------------	-----

Adaptive Highbeam Assist

Activating/deactivating.....	129
------------------------------	-----

Additives

Engine oil.....	359
Fuel.....	358

After-sales service.....	281
--------------------------	-----

Air bag

Front air bag.....	57
Inflating.....	51
Overview.....	57
PASSENGER AIR BAG indicator lamp.....	46
Warning lamp.....	44

Air conditioning menu

Air distribution.....	138
Climate control.....	138

























- Air distribution**
 Adjusting..... 138
 Setting..... 137
- Air inlet**..... 289
- Air pressure**..... 322
- Air vents**
 Adjusting..... 140
- Air/water duct**..... 289
- Airflow**
 Setting..... 137
- Alarm system**..... 94
- All-wheel drive**..... 161
- Alternative route**..... 254
- Ambient lighting**..... 130
- Animals**..... 52
- Anti-lock braking system**..... 174
- Anti-theft alarm system**..... 94
- Anti-theft protection**
 Immobilizer..... 94
- Apps, Mercedes me**
 Mercedes me calls..... 264
- Mercedes me connect..... 267
- Assistance system**..... 174
- ASSYST PLUS**
 Battery disconnection periods..... 282
 Service interval display..... 281
 Service requirements..... 281
- ATA**
 Deactivating the alarm..... 95
 Function..... 94
 Interior protection..... 96
 Interior protection function..... 95
 Tow-away alarm function..... 95
 Tow-away protection..... 95
- ATTENTION ASSIST**
 Function..... 179
 Setting..... 181
- Attention assistant**..... 179
- Authorized Mercedes-Benz Service Center**..... 32
- Authorized workshop**..... 32
- Automatic car wash**..... 290
- Automatic car wash mode**..... 291
- Automatic climate control**..... 138
- Automatic distance control**..... 183
- Automatic driving lights**..... 126
- Automatic emergency call**..... 272
- Automatic engine start/stop**..... 149
- Automatic front passenger air bag shutoff**
 Function..... 48
 Information (child restraint system on
 the front passenger seat)..... 62
 PASSENGER AIR BAG indicator lamp..... 46
- Automatic measures after an accident**..... 50
- Automatic seat adjustment**..... 105
- Automatic transmission**
 DIRECT SELECT lever..... 156
 Drive programs..... 153
 DYNAMIC SELECT button..... 153
 Engages neutral..... 157
 Engaging drive position..... 158
 Engaging reverse gear..... 157
 Faulty gear shift..... 158
 Kickdown..... 160
 Manual gear shifting..... 159
 Oil temperature (driver's display)..... 230
 Selecting park position..... 157

































- Steering wheel paddle shifters..... 159
- Switching gears..... 156
- Transmission position display..... 156
- Transmission positions..... 156
- Autonomous braking**..... 194
- B**
- BAS**..... 175
- Basic information**..... 41
- Battery (12 V battery)**
 - Charging..... 311
 - Notes..... 307
 - Notes (starting assistance and charging)..... 309
 - Replacing..... 312
 - Starting assistance..... 311
- Battery (48 V)**
 - Notes..... 308
- Battery (starter battery)**
 - charging, Remote Online..... 144
- Belt**
 - Fastening..... 44
 - Notes on wearing correctly..... 43
- Releasing..... 56
- Blind Spot Assist**
 - Activating/deactivating..... 203
 - Function..... 202
- Bluetooth®**
 - Connecting a mobile phone..... 263
- Boost pressure, current (driver's display)**..... 230
- Brake Assist**
 - Active Brake Assist..... 194
 - Brake Assist System..... 175
- Brake Assist System**..... 175
- Brake disks**..... 145
- Brake fluid**..... 360
- Brake force distribution**..... 177
- Brake pads**..... 145
- Brakepad gauge**..... 289
- Brakes**
 - ABS (Anti-lock Braking System)..... 174
 - Active Brake Assist..... 194
 - BAS (Brake Assist System)..... 175
 - Checking the brakepad thickness..... 289
 - Driving tips..... 145
- EBD (Electronic Brakeforce Distribution)..... 177
- Electric parking brake..... 168
- Handbrake..... 168
- HOLD function..... 177
- Limited braking effect (salt-treated roads)..... 145
- New/replaced brake pads/brake discs.. 145
- Notes on breaking in a new vehicle..... 145
- Parking brake..... 168
- Post-collision brake..... 50
- Braking assistance**
 - Active Brake Assist..... 194
 - Brake Assist System..... 175
- Breakdown**
 - Changing a wheel..... 344
 - Flat tire..... 301
 - Overview of aids..... 20
 - Tow-starting..... 317
 - Towing methods..... 314
 - Transporting the vehicle..... 316
- Breakdown (Roadside Assistance)**..... 26





- C**
- Calling the customer center for Mercedes-Benz**..... 264
- Calls**
- Mercedes me..... 264
 - Telephone menu..... 263
 - Using overhead control panel..... 264
- Camera**
- 360° camera..... 210
 - Activating using GPS (reversing camera)..... 214
 - Button..... 214
 - Care..... 294
 - Cleaning..... 294
 - Function..... 210
 - Information..... 173
 - Managing activation points..... 214
 - Opening the camera cover (rear view camera)..... 214
 - Rear view camera..... 206
 - Select view..... 214
- Car key**..... 74
- Car wash**
- Automatic car wash..... 290
 - Automatic car wash mode..... 291
 - Power washer..... 292
 - Washing by hand..... 292
- Car-to-X-Communication**
- Display on map..... 256
- Care**
- Air/water duct..... 289
 - Automatic car wash..... 290
 - Automatic car wash mode..... 291
 - Camera..... 294
 - Decorative foil..... 293
 - Display..... 296
 - Exterior lighting..... 294
 - Genuine wood/trim elements..... 296
 - Head-up display..... 296
 - Headliner..... 296
 - Paint..... 292
 - Plastic trim..... 296
 - Power washer..... 292
 - Seat belt..... 296
 - Steering wheel..... 296
 - Vehicle interior..... 296
 - Vehicle parts..... 294
 - Washing by hand..... 292
 - Wheels/rims..... 294
- Care of the headliner**..... 296
- Care of the plastic trim**..... 296
- Care of the steering wheel**..... 296
- Caring for rims**..... 294
- Central display**
- Operating..... 236
- Central locking system**
- Button..... 78
 - SmartKey..... 75
- Change of address**..... 27
- Change of ownership**..... 27
- Changing a wheel**
- Preparation..... 344
 - Raising the vehicle..... 345
- Charging**
- 12 V battery..... 311
 - USB port..... 115, 122
- Checking the brakepad thickness**..... 289
- Checking the coolant level**..... 287
- Child safety lock**
- Rear door..... 71

- Side windows (rear passenger compartment)..... 72
- Child seat**
- Adjusting the vehicle seat..... 64
 - Basic instructions..... 58
 - Front passenger seat..... 62
 - Installing ISOFIX..... 67
 - Rearward-facing..... 64
 - Risks/dangers..... 60
 - Securing on the rear seat with the seat belt..... 70
 - Securing to the front passenger seat with the seat belt..... 70
 - The most important information in brief... 58
 - Top Tether..... 68
- Children**
- Avoiding dangers in the vehicle..... 60
 - Basic instructions..... 58
 - Special seat belt retractor..... 66
- Chock**..... 343
- Clean varnish**..... 292
- Cleaning**
- Air/water duct..... 289
 - Automatic car wash..... 290
 - Automatic car wash mode..... 291
 - Camera..... 294
 - Decorative foil..... 293
 - Genuine wood/trim elements..... 296
 - Paint..... 292
 - Power washer..... 292
 - Sensors..... 294
 - Vehicle interior..... 296
 - Vehicle parts..... 294
 - Washing by hand..... 292
- Cleaning carpet**..... 296
- Cleaning the seat cover**..... 296
- Climate control, Air-conditioning system, Blower, Cooling**
- Activating/deactivating..... 137
 - Activating/deactivating the A/C function (control panel)..... 138
 - Activating/deactivating the A/C function (MBUX)..... 138
 - Activating/deactivating the synchronization function (control panel)..... 139
 - Air vents (front)..... 140
 - Air vents (rear passenger compartment)..... 140
 - Automatic control..... 138
 - Control panel for 3-zone automatic climate control..... 137
 - Control panel for dual-zone automatic climate control..... 137
 - Defrosting the windshield..... 137
 - Defrosting windows..... 139
 - Filling capacity for refrigerant and PAG oil..... 362
 - Notes..... 137
 - Refrigerant..... 362
 - Residual heat..... 139
 - Setting the air distribution..... 137
 - Setting the airflow..... 137
 - Setting the vehicle interior temperature..... 137
 - Switching air-recirculation mode on/off..... 139
 - Switching the rear window heater on/off..... 137
 - Synchronization function..... 139
 - Ventilation with comfort opening..... 88
- COC papers, CERTIFICATE OF CONFORMITY**..... 352
- Cockpit**
- Instrument panel..... 6

- Coffee cup symbol..... 179
- Collision detection (parked vehicle)
Setting..... 170, 171
- Combination switch
Lights..... 126
Windshield wipers..... 131
- Commuter route..... 254
- Components relevant to radio regulation
Declaration of conformity..... 30
- Composition of the tire..... 335
- Control elements:..... 25
- Convenience closing feature..... 88
- Convenience opening..... 88
- Coolant
Capacity..... 361
Notes..... 360
- Copyright
License..... 39
- Copyrights
Trademarks..... 39
- Cornering light function..... 128
- Correct use..... 32
- Cover..... 90
- Cross traffic (warning)..... 224
- Cross Traffic Alert, Cross traffic warning..... 224
- Crosswind Assist..... 176
- Cruise control
Activating/deactivating..... 182
Calling up a speed..... 182
Function..... 181
Requirements:..... 182
Setting a speed..... 182
Storing a speed..... 182
- Customer Assistance Center (CAC)..... 33
- D**
- Damage
Limited protection..... 52
- Dashcam
Notes..... 258
Selecting a USB device..... 259
Starting/stopping an individual recording..... 260
Starting/stopping loop recording..... 259
- Data processing in the vehicle..... 35
- Data protection rights..... 38
- Data storage
Data protection rights..... 38
Electronic control units..... 35
Event Data Recorder..... 38
MBUX multimedia system/Mercedes me connect..... 38
Online services..... 37
- Deactivating the alarm..... 95
- Dealership..... 32
- Declaration of conformity
Components relevant to radio regulation.. 30
- Decorative foil..... 293
- Definitions
Tires and loading..... 338
- Deployed components
Limited protection..... 52
- Deployment situations..... 51
- Destination entry..... 252
- Detecting inattentiveness..... 179
- Diagnostics connection..... 31
- Digital Operator's Manual..... 22

- Dinghy towing**
 Pulling/towing..... 226
- DIRECT SELECT lever**
 Automatic transmission..... 156
 Engages neutral..... 157
 Engaging drive position..... 158
 Engaging park position automatically..... 157
 Engaging reverse gear..... 157
 Function..... 156
 Gearshift recommendation..... 160
 Manual gearshifting..... 159
 Selecting park position..... 157
- Display**
 Care..... 296
- Display (driver's display)**
 Overview of displays..... 232
- Display (MBUX multimedia system)**
 Settings..... 232
- Display message**
 Calling up on driver display..... 364
 Notes..... 364
- Display messages**
 --- mph..... 397
-  --- mph..... 396
-  12 V On-board Electrical System Service Required..... 406
-  48 V Battery See Operator's Manual..... 408
-  Active Headlamps Inoperative..... 371
-  Add Washer Fluid..... 376
-  ATTENTION ASSIST: Take a Break!..... 395
-  Automatic Driving Lights Inoperative..... 371
-  Battery Overheated Stop! Everyone Get Out! Outdoors if Possible.. 408
-  Camera View Reduced See Operator's Manual..... 404
-  Check Brake Fluid Level..... 391
-  Check Coolant Level See Operator's Manual..... 381
-  Check Engine Oil Level At Next Refueling (Add 1 Quart)..... 413
-  Check Left Low Beam (example).. 373
-  Check Tires..... 410
-  Coolant Stop Switch Off Vehicle... 381
-  Currently Unavailable See Operator's Manual..... 392
-  Currently Unavailable See Operator's Manual..... 393
-  Do Not Leave People or Animals in the Vehicle..... 368
-  Don't Forget Your Key..... 370
-  Dynamic Low Beam Inoperative... 372
-  Engine Oil Level Cannot Be Measured..... 415
-  Engine Oil Level Reduce Oil Level..... 414
-  Engine Oil Level Stop Switch Off Vehicle..... 414
-  Engine Oil Pressure Stop Switch Off Vehicle..... 415

-  Front Left Malfunction Service
Required (example)..... 365
-  Fuel Filler Cap Open..... 382
-  Fuel Reserve..... 382
-  Initializing Key Please Wait..... 369
-  Initiating Emergency Stop..... 401
-  Inoperative See Operator's
Manual..... 393
-  Inoperative See Operator's
Manual..... 394
- EBD** Inoperative See Operator's
Manual..... 395
-  SOS Inoperative..... 406
-  Key Not Detected (red display
message)..... 369
-  Key Not Detected (white dis-
play message)..... 368
-  Left Window Airbag Malfunc-
tion Service Required (example)..... 365
-  Malfunction Do Not Exceed 50
mph..... 397
-  Malfunction See Operator's
Manual..... 371
-  Obtain a New Key..... 401
-  Off..... 370
-  Off..... 398
- HOLD** Off..... 395
- PARK** Parking Brake See Operator's
Manual..... 387
- P** Parking Lock Inoperative Apply
Parking Brake..... 386
-  Please Correct Tire Pressure..... 411
-  Please Wait Charging 48 V Bat-
tery..... 409
-  Reduce Speed..... 413
- PARK** Release Parking Brake..... 390
-  Replace Key Battery..... 368
-  Restraint System Malfunc-
tion Service Required..... 365
-  Steering Malfunction Increased
Physical Effort See Operator's Manual.... 378
-  Steering Malfunction See Oper-
ator's Manual..... 378
-  Steering Malfunction Stop
Immediately See Operator's Manual..... 377
-  Stop Vehicle See Operator's
Manual..... 407
-  Stop Vehicle To Charge the 12
V Battery Do Not Switch Off Vehicle..... 408
-  Suspended..... 397
-  Switch Off Lights..... 372
-  Switch On Headlights..... 372
-  Switch on vehicle to charge the
12 V battery..... 407
- PARK** Switch on Vehicle to Release
the Parking Brake..... 391
-  Temporarily Unavailable Sen-
sors Dirty..... 403
-  Tires Overheated..... 412

-  Transmission Oil Overheated Drive with Caution..... 385
-  Turn Steering Wheel Before Starting Vehicle..... 379
-  Warning Tire Malfunction..... 412
-  Wheel Sensor(s) Missing..... 410
- Active Brake Assist Functions Currently Limited See Operator's Manual..... 399
- Active Brake Assist Functions Limited See Operator's Manual..... 399
- Active Distance Assist Currently Unavailable See Operator's Manual..... 398
- Active Distance Assist Inoperative..... 398
- Active Distance Assist Now Available..... 399
- Active Lane Keeping Assist Currently Unavailable See Operator's Manual..... 402
- Active Lane Keeping Assist Inoperative... 402
- Active Lane Keeping Assist Limited Range of Functions See Operator's Manual..... 403
- Active Parking Assist and PARKTRONIC Inoperative See Operator's Manual..... 405
- Active Steering Assist Currently Unavailable Due to Multiple Emergency Stops..... 401
- Active Steering Assist Currently Unavailable See Operator's Manual..... 400
- Active Steering Assist Inoperative..... 400
- Adaptive Highbeam Assist Currently Unavailable See Operator's Manual..... 373
- Adaptive Highbeam Assist Inoperative.... 373
- Auxiliary Battery Malfunction (red display message)..... 387
- Auxiliary Battery Malfunction (white display message)..... 386
- Blind Spot Assist Currently Unavailable See Operator's Manual..... 401
- Blind Spot Assist Inoperative..... 402
- Cannot Start Vehicle See Operator's Manual..... 375
- Check Brake Pads See Operator's Manual..... 392
- Cruise Control Inoperative..... 396
- Cruise Control Off..... 396
- Depress Brake to Shift from P..... 383
- Depress Brake to Shift to D or R..... 383
- Depress Brake to Shift to R..... 383
- Front Passenger Airbag Disabled See Operator's Manual..... 366
- Front Passenger Airbag Enabled See Operator's Manual..... 366
- Hazard Warning Light Malfunction..... 374
- Head-up Display Currently Unavailable See Operator's Manual..... 377
- Head-up Display Inoperative..... 377
- MULTIBEAM LED Functions Limited..... 372
- N Permanently Active Risk of Rolling Away..... 384

Occupant Presence Reminder Inoperative.....	367	Shift to P Only When Vehicle Is Stationary.....	382	Transmission Malfunction.....	385
PARKTRONIC Inoperative See Operator's Manual.....	405	Starting Possible Again.....	409	Transmission Malfunction Service Required.....	386
Place the Key in the Marked Space See Operator's Manual.....	370	Teaching in Transmission Complete.....	386	Transmission Malfunction Stop.....	384
PRE-SAFE Inoperative See Operator's Manual.....	405	Teaching in Transmission Operate Selector Lever Apply Brake for XX s Risk of Vehicle Rolling Away.....	386	Vehicle Ready to Drive Shutdown Occurs When Locked or After a Few Minutes.....	376
Reduced Drive System Performance See Operator's Manual.....	374	Tire Pressure Monitor Currently Unavailable.....	409	Vehicle Ready to Drive Shutdown Occurs When Locked or Automatically in XX Mins.....	375
Reversing Not Possible Service Required.....	384	Tire Pressure Monitor Inoperative.....	410	Windshield Wiper Malfunction.....	376
Risk of Vehicle Rolling Away Apply Parking Brake When Parking.....	384	Tire Pressure Monitor Inoperative Tire Pressure Sensors Missing.....	410	Displaying road names/house numbers.....	254
Risk of Vehicle Rolling Away Driver's Door Open Position P Not Selected.....	384	To Deselect P or N Depress Brake and Start Vehicle.....	383	Distance control.....	183
Service Required Apply Parking Brake to Park.....	383	To Switch Off Vehicle Press and Hold Start/Stop Button for at Least 3 Seconds or Press 3 Times.....	380	Distance warning.....	194
Service Required Do Not Change Transmission Position.....	385	Traffic Sign Assist Currently Unavailable See Operator's Manual.....	396	DISTRONIC.....	183
		Traffic Sign Assist Inoperative.....	396	Door	
				Child safety lock (rear door).....	71
				Emergency key.....	81
				Opening (from the inside).....	78
				Unlocking (inside).....	78

- Door operating unit**
 Function seat..... 18
- DOT, Tire Identification Number (TIN)**..... 333
- Drinking and driving**..... 145
- Drive Away Assist**..... 223
- Drive position**..... 158
- Drive program display**..... 154
- Drive programs**
 Selecting..... 154
- Driver display**
 Identifying malfunctions..... 227
- Driver's display, Instrument cluster**
 48 V on-board electrical system..... 232
 Head-up display..... 230
 Instrument cluster..... 8
 Menus..... 229
 Notes..... 227
 Operating..... 228
 Service due date..... 281
 Status displays..... 232
 Warning/indicator lamps..... 415
- Driver's seat**
 Adjusting (Seat Comfort)..... 100
 Adjusting (without seat comfort)..... 98
 Adjusting electrically..... 103
 Easy entry and exit feature..... 109
 Seat heating..... 106
- Driving safety system**
 ABS (Anti-lock Braking System)..... 174
 Active Brake Assist..... 194
 Active Steering Assist..... 190
 ATTENTION ASSIST..... 179
 BAS (Brake Assist System)..... 175
 Blind Spot Assist..... 202
 Cameras..... 173
 Cruise control..... 181
 EBD (Electronic Brakeforce Distribution)..... 177
 ESP® (Electronic Stability Program)..... 175
 Hill Start Assist..... 178
 HOLD function..... 177
 Overview..... 174
 Radar and ultrasonic sensors..... 173
 STEER CONTROL..... 177
 Traffic Sign Assist..... 198
 Your responsibility..... 172
- Driving system**..... 174
- Driving tips**
 Drinking and driving..... 145
 General driving tips..... 145
 Notes on breaking in a new vehicle..... 145
- Drowsiness detection**..... 179
- Duplicate key**..... 77
- Dynamic handling control system**..... 175
- DYNAMIC SELECT**
 Calling up the fuel consumption indicator..... 155
 Configuring drive program I..... 154
 Displaying engine data..... 155
 Displaying vehicle data..... 155
 Drive program display..... 154
 Drive programs..... 153
 Function..... 153
 Selecting the drive program..... 154
- E**
- E10**..... 357
- E25**..... 357
- Easy entry feature**
 Adjusting..... 110

- Function..... 109
- Easy exit feature**
- Adjusting..... 110
 - Function..... 109
- EBD, Electronic Brakeforce Distribution**..... 177
- ECO Assist**
- 48 V on-board electrical system..... 151
- ECO display**..... 150
- ECO start/stop button**
- Automatic engine start/stop..... 150
- ECO start/stop function**
- Automatic engine start..... 149
 - Automatic engine stop..... 149
 - Function..... 149
 - Switching off/on..... 150
- Electric parking brake**
- Applying automatically..... 168
 - Emergency braking..... 170
 - Manually applying/releasing..... 170
 - Releasing automatically..... 169
- Electrical fuses**..... 318
- Electronic Stability Program**..... 175
- Emergency**
- First-aid kit (soft sided)..... 301
 - Overview of aids..... 20
 - Reflective safety vest..... 299
 - Warning triangle..... 300
- Emergency braking**
- Active Brake Assist..... 194
 - Brake Assist System..... 175
 - Carrying out..... 170
 - Electric parking brake/handbrake..... 168
- Emergency key**
- Door..... 81
- Emergency operation mode**
- Starting the vehicle..... 143
- Emergency release**
- Trunk lid (from inside)..... 86
- Emergency spare wheel**
- Inflating..... 350
- Emergency stop assistant**..... 192
- Emergency Tensioning Devices**
- Inflating..... 51
- Engine**
- Emergency operation mode..... 143
 - Emergency start..... 317
 - Engine number..... 354
 - Jump-starting..... 309
 - Parking (start/stop button)..... 164
- Engine data**
- Displaying..... 155
 - DYNAMIC SELECT..... 155
- Engine number**..... 354
- Engine oil, Oil**
- Additives..... 359
 - Capacity..... 359
 - Checking the oil level using the driver display..... 285
 - MB-Freigabe or MB-Approval..... 359
 - Quality..... 359
 - Refilling..... 286
 - Temperature (driver's display)..... 230
- Engine oil temperature (driver's display)**..... 230
- Engine output, current (driver's display)**..... 230
- Environmentally friendly driving**..... 23
- ESC, Electronic Stability Control**..... 175
- ESP®**
- Activating/deactivating..... 176

- | | | | | | |
|--|------------|-----------------------------------|------------|--|------------|
| Crosswind Assist..... | 176 | Fitting accessories | | Front passenger air bag shutoff, | |
| Function..... | 175 | Limited protection..... | 52 | PASSENGER AIR BAG OFF | |
| Event Data Recorder..... | 38 | Flat tire | | Information (child restraint system on | |
| Exit warning | | Changing a wheel..... | 344 | the front passenger seat)..... | 62 |
| Blind Spot Assist..... | 202 | MOExtended..... | 302 | Front passenger seat | |
| Exiting a parking space | | Notes..... | 301 | Adjusting (Seat Comfort)..... | 100 |
| Active Parking Assist..... | 218 | TIREFIT kit..... | 303 | Adjusting (without seat comfort)..... | 98 |
| Drive Away Assist..... | 223 | Flat towing | | Adjusting electrically..... | 103 |
| PARKTRONIC..... | 214 | Pulling/towing..... | 226 | Fuel | |
| Exterior lighting | | Floor mats..... | 124 | Additives..... | 358 |
| Care..... | 294 | Fog lamp..... | 126 | E10..... | 357 |
| Exterior mirrors | | Foil covering | | E25..... | 357 |
| Parking position..... | 135 | Radar and ultrasonic sensors..... | 173 | Gasoline..... | 357 |
| F | | Free software..... | 39 | Quality (gasoline)..... | 357 |
| Factory settings | | Frequencies | | Refilling..... | 161 |
| MBUX reset function..... | 249 | Mobile phone..... | 353 | Reserve..... | 359 |
| Favorites..... | 243 | Two-way radio..... | 353 | Sulfur content..... | 357 |
| Film coverings | | Front air bag | | Tank capacity..... | 359 |
| On camera/sensors..... | 173 | Inflating..... | 51 | Fuel consumption indicator..... | 155 |
| First aid | | Front headlamps..... | 125 | Fuel reserve..... | 359 |
| First-aid kit (soft sided)..... | 301 | Front passenger air bag | | Function in the event of an accident..... | 51 |
| First-aid kit (soft sided)..... | 301 | Disabling/enabling..... | 48 | Function seat..... | 18 |

- Fuses**
 Engine compartment..... 319
 Fuse assignment diagram..... 318
 Notes..... 318
 Passenger footwell..... 319
 Trunk..... 320
- G**
- G-meter, Accelerometer**..... 230
- Garage door opener**
 Clearing the memory..... 168
 Opening/closing a door..... 168
 Problem..... 167
- Garage door openers**
 Programming buttons..... 166
 Synchronizing the rolling code..... 167
- Gasoline**..... 357
- Gearshift**
 DIRECT SELECT lever..... 156
 Manual..... 159
- General driving tips**..... 145
- Genuine parts**..... 23
- Glide mode**..... 160
- Glove box**
 Locking/unlocking..... 115
- Grab handles**..... 98
- H**
- Handbrake**..... 168
- Handling characteristics**
 Unusual..... 321
- HANDS-FREE ACCESS**..... 84
- Hazard warning lights**..... 127
- Hazard warnings**
 Car-to-X-Communication..... 256
- Head restraint**
 Adjusting (rear passenger compartment)..... 105
 Adjusting manually (front)..... 104
 Removing/installing (rear passenger compartment)..... 105
- Head-up display**
 Care..... 296
 Function..... 230
 Memory function..... 111
 Operating..... 231
- Switching on/off..... 231
- Headlamp flashing**..... 126
- Headlamps**..... 125
- Heating**
 Activating/deactivating..... 137
 Seat..... 106
- Help call**
 Mercedes-Benz emergency call system.. 271
- High beam**..... 126
- Hill Start Assist**..... 178
- HOLD function**
 Function..... 177
 Switching on/off..... 178
- Home screen**
 Central display..... 235
- Hood**
 Opening/closing..... 283
- I**
- Identification plate**
 Engine..... 354
 Refrigerant..... 362
 Vehicle..... 354

- Immobilizer**..... 94
Incorrect behavior by vehicle occupants
 Limited protection..... 52
Indicator/warning lamps
 Driver's display..... 415
 PASSENGER AIR BAG..... 46
Individual drive program
 Configuring..... 154
Inside rearview mirror..... 135
Installing
 Snow chains..... 322
 Tires/wheels..... 348
Instrument panel
 Cockpit..... 6
Interior lighting
 Adjusting..... 130
 Ambient lighting..... 130
 MBUX reading light..... 240
 Switch-off delay time..... 131
Interior protection..... 96
Internet
 Mercedes me connect..... 267
 Setting up a Wi-Fi hotspot..... 246
 Web browser..... 269
ISOFIX child seat anchor
 Installing..... 67
J
Jack
 Storage location..... 343
Jump-start connection..... 311
K
Key
 Problem..... 77
 Replacement key..... 77
KEYLESS-GO
 Deactivating..... 75
 Locking/unlocking the vehicle..... 79
 Problem..... 80
 Unlocking setting..... 75
Kickdown..... 160
Knee bag..... 57
L
Lane Keeping Assist..... 204
Lane recognition
 Active Lane Keeping Assist..... 204
Language
 Notes..... 248
 Setting..... 248
License plate (front)..... 30
License plate assembly (front)..... 30
Light switch..... 125
Lighting
 Interior lighting..... 130
Lights
 Active headlamps..... 128
 Adaptive Highbeam Assist..... 128
 Automatic driving lights..... 126
 Combination switch..... 126
 Cornering light function..... 128
 Hazard warning lights..... 127
 High beam..... 126
 Interior lighting..... 130
 Locator lighting..... 130
 Reading lamp..... 130
 Reading light..... 240
 Rear fog light..... 126
 Responsibility for lighting systems..... 125

Switch-off delay time.....	130	Loud sound	
Turn signals.....	126	PRE-SAFE® Sound.....	49
Limited Warranty	34	Low-beam headlamps	
Live Traffic Information	256	Activating/deactivating.....	125
Load index		Lubricants	356
Tires.....	335	Luggage	112
Load-bearing capacity		Luggage rack	112
Tires.....	335	Lumbar support	103
Loading			
Definitions.....	338	M	
Notes.....	112	Maintaining safe distance	
Roof luggage rack.....	119	Active Distance Assist DISTRONIC.....	186
Tie-down eyes.....	118	Maintenance	
Loading guidelines	112	Vehicle.....	26
Loading information table	328	Maintenance Management	
Loads	112	Notes.....	282
Locator lighting	130	Transferred data.....	282
Locking/unlocking		Malfunction	
Automatic locking (MMS).....	80, 81	Driver display.....	227
Doors (from the inside).....	78	Restraint system.....	44
Emergency key.....	81	Malfunction message	
KEYLESS-GO.....	79	Driver's display.....	364
		Maneuvering	
		Maneuvering brake function.....	225
		Maneuvering assistant	
		Activating/deactivating.....	225
		Drive Away Assist.....	223
		Maneuvering brake function.....	225
		Maneuvering brake function	225
		Manual gearshifting	
		Activating/deactivating.....	160
		Map	
		Displaying online map contents.....	256
		Displaying weather information.....	256
		Moving.....	256
		Selecting the map orientation.....	256
		Setting the map scale.....	256
		Map functions	256
		Massage programs	106
		Maximum full-stop braking	175
		Maximum permissible load	
		Calculation example.....	330
		Determining.....	329
		Maximum tire load	334
		Maximum tire pressure	335

- MBUX**
 Dashcam..... 258
- MBUX Interior Assistant**
 Overview..... 239
 Reading light..... 240
 Search light..... 240
- MBUX multimedia system**
 Activating/deactivating standby mode... 172
 Configuring display settings..... 232
 Drive programs..... 154
 Factory setting..... 249
 Home screen..... 235
 Language settings..... 237
 MBUX Interior Assistant..... 239
 Media..... 274
 Mercedes me & Apps..... 269
 Notes..... 234
 Overview..... 235
 Set collision detection..... 170, 171
 Setting route-based speed adaptation.... 190
 Standby mode function..... 172
 Telephone..... 261
 Touchscreen..... 236
- MBUX reading light**..... 240
- MBUX search light**..... 240
- MBUX Voice Assistant**
 Function..... 237
 Voice prompting..... 238
- Mechanical key**
 Inserting/removing..... 76
- Media**
 Overview of functions/symbols..... 274
- Medical aids**..... 33
- Memory function**
 Head-up display..... 111
 Outside mirrors..... 111
 Seat..... 111
- Menus (driver's display)**
 Notes..... 229
 Sport..... 230
- Mercedes me App**
 Activating on-demand features..... 26
- Mercedes me Apps**..... 269
- Mercedes me calls**
 Arranging a service appointment..... 266
- Calling the Mercedes-Benz customer center after automatic accident/
 breakdown detection..... 265
 Calls via the overhead control panel..... 264
 Information..... 264
 Mercedes-Benz customer center..... 264
 Transferred data..... 266
- Mercedes me connect**
 Accident/Breakdown Management..... 268
 Information..... 267
 Transferred data..... 269
- Mercedes-AMG vehicles, Notes**..... 141
- Mercedes-Benz emergency call system, Emergency call**
 Automatic emergency call..... 272
 Data transfer..... 273
 Information..... 271
 Manual emergency call..... 272
 Overview..... 271
- Mercedes-Benz GenuineParts**..... 23
- Message memory**..... 364
- Mirrors**
 Outside mirrors..... 134
 Rearview mirror..... 135

- Mobile phone**
 - Frequencies..... 353
 - Maximum transmission output..... 353
 - Notes on wireless charging..... 122
 - Model type**..... 354
 - Modification**
 - Limited protection..... 52
 - MOExtended tires, Run-flat tires**..... 302
 - Multimedia system**..... 235
- N**
- Navigation**
 - Activating..... 250
 - Destination entry..... 252
 - Notes..... 249
 - Overview..... 250
 - Neutral**..... 157
 - Non-operational time**
 - Activating/deactivating standby mode... 172
 - Notes on breaking in a new vehicle**..... 145
- O**
- Objects in the vehicle interior**
 - Limited protection..... 52
 - Occupant presence reminder**
 - Activating/deactivating..... 73
 - Function..... 72
 - Occupant safety**
 - Air bag..... 57
 - Basic information..... 41
 - Child seat..... 58
 - Information on the child restraint system..... 48
 - Information on the correct seat position... 42
 - Occupant presence reminder..... 72
 - Pets in the vehicle..... 52
 - PRE-SAFE®..... 49
 - On-board diagnostics interface**..... 31
 - On-board electronics**
 - Two-way radios..... 352
 - On-demand feature**..... 25, 26
 - Online services**..... 37
 - Open Source Software**..... 39
 - Opening the trunk lid using your foot**
 - HANDS-FREE ACCESS..... 84
 - Opening/closing a door**..... 168
 - Opening/closing a garage door**..... 168
 - Operating fluids**
 - Additives..... 358
 - Brake fluid..... 360
 - coolant..... 360
 - Engine oil..... 359
 - Fuel (gasoline)..... 357
 - Notes..... 356
 - Refrigerant (air conditioning system)..... 362
 - Windshield washer fluid..... 361
 - Operating safety**
 - 48 V on-board electrical system..... 27
 - Operator's manual**..... 24
 - Operator's Manual digital**..... 22
 - Outside mirrors**
 - Automatic anti-glare mode..... 135
 - Blind Spot Assist..... 202
 - Folding in/out..... 134
 - Memory function..... 111
 - Setting..... 134

- Warning lamp..... 202
- Overhead control panel**..... 16
- P**
- Paddle shifters**
Steering wheel paddle shifters..... 159
- Paint code**..... 354
- Panic alarm, Alarm**
Activating/deactivating..... 75
- Park position**
DIRECT SELECT lever..... 156
- Parking**
Active Parking Assist..... 218
PARKTRONIC..... 214
- Parking Assist**
Active Parking Assist..... 218
PARKTRONIC..... 214
- Parking Assist PARKTRONIC**
Activating/deactivating..... 217
Adjusting warning tones..... 218
Function..... 214
- Parking assistance systems**
Active Parking Assist..... 218
- Drive Away Assist..... 223
Maneuvering brake function..... 225
PARKTRONIC..... 214
- Parking brake**..... 168
- Parking for an extended period**..... 171
- Parking lamps**..... 125
- Parking lights**..... 125
- Parking position**
Exterior mirrors..... 135
Storing the position of the front-passenger outside mirror using reverse gear..... 136
- PARKTRONIC**..... 214
- PASSENGER AIR BAG**
Status display, front passenger air bag.... 46
- Payload**
Calculation example..... 330
Determining the maximum..... 329
- Permitted towing methods**
Overview..... 313
- Personalization**..... 241
- Pets in the vehicle**..... 52
- Post-collision brake**..... 50
- Power supply**
Start/stop button..... 141
Switching on (start/stop button)..... 141
- Power washer**..... 292
- PRE-SAFE®**, Anticipatory occupant protection
Function..... 49
PRE-SAFE® Sound..... 49
Reverting measures..... 50
- Preventative occupant protection system**..... 49
- Profile**..... 241
- Programs**..... 153
- Protection**
Limited..... 52
- Protection against collision**
Maneuvering brake function..... 225
- Protection of the environment**
Driving style..... 23
- Pulling away**
Hill Start Assist..... 178
Start-off assist..... 179

Q

- QR code rescue card..... 34
- Qualified specialist workshop..... 32

R

- Radar and ultrasonic sensors..... 173
- Radio..... 276
- Radio regulations
 - Regulatory radio identification..... 354
- Rain closing function
 - Sliding sunroof..... 92
- Rain sensor
 - Sliding sunroof..... 92
 - Windshield wipers..... 131
- Reading lamp
 - Interior lighting..... 130
- Rear door (child safety lock)
 - Securing..... 71
- Rear fog light..... 126
- Rear passenger compartment seat belt
 - Status display..... 45

Rear view camera

- 360° Camera..... 206
- Function..... 206
- Opening the camera cover..... 214

Rear window heater..... 137**Rearview mirror**

- Automatic anti-glare mode..... 135

Rearward-facing child seat

- Information..... 64

Reflective safety vest..... 299**Refrigerant..... 362****Refueling**

- Fuel..... 161
- Refueling the vehicle..... 161

Regulatory radio information

- Specific absorption rate..... 354

Remote Online

- Charging the starter battery..... 144
- Cooling/heating the vehicle interior..... 144
- Starting the vehicle..... 144

Replacement key..... 77**Reporting safety defects..... 33****Reserve**

- Fuel..... 359

Resetting

- MBUX reset function..... 249

Residual heat..... 139**Responsibility**

- Driving safety systems..... 172

Restraint system

- Basic information..... 41
- Basic instructions for children..... 58
- Deployment situations..... 51
- Functionality..... 44
- Information on function..... 51
- Information on the correct seat position... 42
- Limited protection..... 52
- Malfunction..... 44
- Protection..... 42
- Self-test..... 44
- Warning lamp..... 44

Reverse gear

- DIRECT SELECT lever..... 156

Reversing camera

- Activating via GPS..... 214
- Managing activation points..... 214

Roadside Assistance (breakdown).....	26
Roll away protection.....	177
Roller sunblind	
Sliding sunroof.....	90
Roof luggage rack	
Loading.....	119
Securing.....	119
Route	
Alternative route.....	254
Calculating.....	254
Commuter route.....	254
Navigation.....	250
Selecting a type.....	254
Route guidance with augmented reality	
Activating.....	254
Displaying road names/house numbers.....	254
Switching video on or off.....	254
Route-based speed adaptation	
Function.....	188
Setting.....	190
Run-flat characteristics.....	302

S

Safety system.....	174	Rear passenger compartment seat belt status display.....	45
Satellite radio		Warning lamp.....	45
Logging in.....	279	Seat belt adjustment	
Setting music and sport alerts.....	279	Activating/deactivating.....	50
Seat, Through-loading feature		Function.....	50
Adjusting (Seat Comfort).....	100	Seat belt warning.....	45
Adjusting (without seat comfort).....	98	Seat belts	
Adjusting electrically.....	103	Activating/deactivating seat belt adjustment.....	50
Automatic adjustment.....	105	Fastening.....	44
Correct driver's seat position.....	97	Notes on wearing correctly.....	43
Folding back the backrest (rear passenger compartment).....	117	Releasing.....	56
Folding backrest forward (rear).....	116	Seat heating	
Locking the backrest (rear passenger compartment).....	118	Activating/deactivating.....	106
Lumbar support.....	103	Seat ventilation	
Memory function.....	111	Activating/deactivating.....	107
Resetting settings (massage programs).....	106	Selecting a gear.....	159
Settings.....	18	Selector lever.....	156
Side impact air bag.....	57	Self-test	
Seat belt		Automatic front passenger air bag shutoff.....	46
Automatic tightening.....	50	Restraint system.....	44
Care.....	296		



















- Sensors**
 - Cleaning..... 294
 - Information..... 173
- Service**..... 281
- Service center**..... 32
- Service due date**..... 281
- Service interval display**..... 281
- Shifting**
 - Automatic transmission..... 159
 - Gearshift recommendation..... 160
 - Manual..... 159
 - Steering wheel paddle shifters..... 159
- Shortening the braking distance**
 - Brake Assist System..... 175
- Shunting support**..... 224
- Side impact air bag**..... 57
- Side window**
 - Window films..... 294
- Side windows**
 - Child safety lock (rear passenger compartment)..... 72
 - Closing with SmartKey..... 88
 - Convenience closing feature..... 88
 - Convenience opening..... 88
 - Opening with the SmartKey..... 88
 - Opening/closing..... 86
 - Problem..... 89
- Size designation**
 - Tires..... 335
- Skid chains**..... 322
- Sliding sunroof, Panorama roof with power tilt/sliding panel**
 - Automatic functions..... 92
 - Closing with SmartKey..... 88
 - Opening with the SmartKey..... 88
 - Opening/closing..... 90
 - Problem..... 93
 - Rain closing function..... 92
- SmartKey**
 - Acoustic locking verification signal..... 75
 - Battery..... 76
 - Deactivating a function..... 75
 - Function..... 74
 - Key ring attachment..... 76
 - Mechanical key..... 76
 - Panic alarm..... 75
 - Power consumption..... 75
 - Unlocking setting..... 75
- Smartphone Integration, iPhone®**
 - Android Auto..... 270
 - Apple CarPlay®..... 270
- Snow chains**..... 322
- Socket**
 - 12 V (front center console)..... 120
 - 12 V (trunk/cargo compartment)..... 120
 - 115 V (rear passenger compartment)..... 121
- Software update**..... 245
- SOS button**..... 264
- Sound**
 - Menu..... 280
 - PRE-SAFE® Sound..... 49
 - Wheels/tires..... 321
- Sound settings**..... 280
- Spare parts**..... 23
- Spare wheel**..... 349
- Special seat belt retractor**..... 66
- Specialist workshop**..... 32
- Specific absorption rate (SAR)**..... 354















- Speed**
Save, cruise control..... 186
Save, DISTRONIC..... 186
- Speed adaptation, Route-based**..... 188
- Speed control**
Active Distance Assist DISTRONIC..... 183
Cruise control..... 181
- Speed rating**
Tires..... 335
- Start-off assist**
Activating..... 179
Function..... 179
Hill Start Assist..... 178
- Start/stop button**
Parking the vehicle..... 164
Starting the vehicle..... 142
Switching on the power supply / vehicle..... 141
- Start/stop function**..... 149
- Starter battery**
charging, Remote Online..... 144
- Starting**
Remote Online..... 144
- Start/stop button..... 142
- Starting assistance**..... 311
- Starting the engine**
Emergency operation mode..... 143
Remote Online..... 144
Start/stop button..... 142
- Starting-off aid**
Drive Away Assist..... 223
Hill Start Assist..... 178
Start-off assist..... 179
- Status display**
Front passenger air bag..... 46
Rear passenger compartment seat belt... 45
- Steer Assist**
Active Steering Assist..... 190
STEER CONTROL..... 177
- STEER CONTROL**..... 177
- Steering wheel**
Driver's air bag..... 57
Manually adjusting..... 108
Steering wheel heater..... 109
- Steering wheel heater**..... 109
- Steering wheel paddle shifters**..... 159
- Stop and go**
ECO start/stop function..... 150
- Stopping**
Parking the vehicle..... 164
- Stowage areas**..... 115
- Stowage spaces**
Armrest (front)..... 115
Center console (front)..... 115
Door..... 115
Glove box..... 115
- Substances hazardous to health**..... 27
- Sulfur content**..... 357
- Suspension**
Adaptive damping system..... 206
- Switch-off delay time**
Exterior..... 130
Interior..... 131
- Switching air-recirculation mode on/off**..... 139
- Synchronization function**
Activating/deactivating (control panel)... 139
- System settings**
MBUX reset function..... 249
Overview..... 244

- T**
- Tank capacity**
 - Fuel..... 359
 - Reserve..... 359
 - Tank filler cap / flap**..... 161
 - Technical data**
 - Information..... 352
 - Radio frequencies..... 353
 - Radio regulations..... 354
 - Specific absorption rate (SAR)..... 354
 - Vehicle dimensions..... 363
 - Telediagnosis**
 - Diagnostic data..... 282
 - Telediagnosics**
 - Transferred data..... 283
 - Telephone, Smartphone**
 - Bluetooth®..... 263
 - Charging wirelessly (mobile phone)..... 123
 - Connecting a mobile phone..... 263
 - Menu..... 263
 - Notes..... 261
 - Notes on wireless charging (mobile phone)..... 122
 - Operating modes..... 263
 - Secure Simple Pairing..... 263
 - Telephone menu overview..... 262
 - Telephony operating modes**
 - Bluetooth® telephony..... 263
 - Temperature**
 - Setting the vehicle interior temperature..... 137
 - Temperature grade**..... 332
 - Tie-down eyes**..... 118
 - TIN (Tire Identification Number)**..... 333
 - Tire and Loading Information placard**..... 328
 - Tire information table**..... 328
 - Tire labeling**
 - Load index..... 335
 - Load-bearing capacity..... 335
 - Size designation..... 335
 - Speed rating..... 335
 - Temperature grade..... 332
 - Tire Quality Grading..... 332
 - Traction grade..... 332
 - Tread wear grade..... 332
 - Tire lettering**
 - Composition..... 335
 - DOT, Tire Identification Number (TIN)..... 333
 - Maximum tire load..... 334
 - Maximum tire pressure..... 335
 - Tire pressure**
 - Checking..... 326
 - Checking manually..... 325
 - maximum..... 335
 - Notes..... 322
 - Tire pressure table..... 324
 - TIREFIT kit..... 303
 - Tire pressure monitor**
 - Function..... 325
 - Tire pressure monitoring system**
 - Restarting..... 327
 - Tire pressure table**..... 324
 - Tire Quality Grading**..... 332
 - Tire sealant**..... 303
 - Tire tread**..... 321
 - Tire-change tool**..... 343
 - Tire-change tool kit**..... 343

- TIREFIT kit**, Tire inflation compressor
 Storage location..... 302
- Tires**
 Breakdown..... 301
 Checking..... 321
 Checking the temperature..... 326
 Checking the tire pressure manually..... 325
 Composition..... 335
 Definitions..... 338
 DOT, Tire Identification Number (TIN)..... 333
 Installing..... 348
 Labeling..... 332
 Load index..... 335
 Load-bearing capacity..... 335
 Maximum pressure..... 335
 Maximum tire load..... 334
 MOExtended..... 302
 Noise..... 321
 Notes on installing..... 340
 Removing..... 347
 Removing/installing hub cap..... 344
 Removing/installing wheel trim..... 344
 Replacing..... 340, 344
 Rotating..... 343
 Selecting..... 340
- Size designation..... 335
 Snow chains..... 322
 Speed rating..... 335
 Storing..... 343
 Temperature grade..... 332
 Tire and Loading Information placard..... 328
 Tire pressure table..... 324
 Tire Quality Grading..... 332
 TIREFIT kit..... 303
 Traction grade..... 332
 Tread wear grade..... 332
 Unusual handling characteristics..... 321
- Toll system**
 Debiting toll fees..... 250
- Top Tether**..... 68
- Torque (driver's display)**..... 230
- Touch Control**
 Driver display..... 227
 Driver's display..... 228
 MBUX..... 236
- Touch-sensitive controls**..... 25
- Touchscreen**..... 236
- Tow bar system**
 Towing away..... 226
- Tow-away protection**..... 95
- Tow-starting**..... 317
- Towing**
 Towing methods..... 313
- Towing eye**
 Storage location..... 317
- Towing methods**
 Both axles on the ground..... 314
 Overview..... 313
- Traction grade**..... 332
- Traffic information**..... 256
- Traffic light warning/display**..... 198
- Traffic Sign Assist**
 Function..... 198
 Setting..... 202
- Trailer drawbar**, Pulling/towing..... 226
- Transmission position display**..... 156
- Transmission positions**
 DIRECT SELECT lever..... 156

- Transporting**
 - Vehicle..... 316
 - Tread wear grade**..... 332
 - Trunk lid**
 - Closing..... 83
 - Emergency release (from inside)..... 86
 - HANDS-FREE ACCESS..... 84
 - Limiter..... 86
 - Opening..... 82
 - TuneIn Internet Radio**..... 278
 - Turn signal indicator**..... 126
 - Turn signals**..... 126
 - Two-way radios**
 - Frequencies..... 353
 - Installation..... 352
 - Transmission output..... 353
- U**
- Unfastening**..... 56
 - Unlocking setting**..... 75
 - Updates**..... 245
 - USB port**
 - Rear passenger compartment..... 122
 - Storage compartments (front)..... 115
 - User profiles**
 - Adding a user..... 243
 - Note..... 241
 - Selecting options..... 243
- V**
- Vehicle, Switching on the ignition**
 - 48 V on-board electrical system..... 27
 - Activating, Remote Online..... 144
 - Activating/deactivating standby mode... 172
 - Correct use..... 32
 - Data storage..... 35
 - Diagnostics connection..... 31
 - Emergency key..... 81
 - Equipment..... 24
 - KEYLESS-GO..... 79
 - Limited Warranty..... 34
 - lock automatically (MMS)..... 80, 81
 - Locking/unlocking (emergency key)..... 81
 - Locking/unlocking (from inside)..... 78
 - Lowering..... 349
 - Maintenance..... 26
 - Medical aids..... 33
 - Parking..... 164
 - Parking for an extended period..... 171
 - Problem notification..... 33
 - Pulling..... 226
 - QR code rescue card..... 34
 - Raising..... 345
 - Set collision detection..... 170, 171
 - Standby mode function..... 172
 - Starting (start/stop button)..... 142
 - starting, emergency operation mode..... 143
 - Stopping..... 164
 - Switching off (start/stop button)..... 164
 - Switching on (start/stop button)..... 141
 - Towing away..... 313
 - Transporting..... 316
 - Ventilating / comfort opening..... 88
 - Vehicle cameras**..... 173
 - Vehicle data**
 - Display, MBUX..... 155
 - Displaying, DYNAMIC SELECT..... 155
 - Turning circle..... 363
 - Vehicle height..... 363
 - Vehicle length..... 363
 - Vehicle width..... 363
 - Weights..... 363
 - Wheelbase..... 363

- Vehicle dimensions**..... 363
- Vehicle emergency start**..... 317
- Vehicle equipment**..... 24
- Vehicle identification plate**
 Model type..... 354
 Paint code..... 354
 VIN..... 354
- Vehicle interior**
 Cooling/heating (Remote Online)..... 144
- Vehicle key**..... 74
- Vehicle operation outside the USA or Canada**..... 26
- Vehicle sensors**..... 173
- Vehicle start**
 Emergency operation mode..... 143
 Remote Online..... 144
 Start/stop button..... 142
- Vehicle tool kit**
 TIREFIT kit..... 302
 Towing eye..... 317
- Ventilating**..... 88
- Ventilation**..... 140
- Vents**
 Air vents..... 140
- VIN, Vehicle identification number**
 Engine compartment..... 354
 Identification plate..... 354
 Windshield..... 354
- Vision**
 Defrosting windows..... 139
- Voice assistant**
 Voice prompting..... 238
- W**
- Warning system**..... 94
- Warning triangle**..... 300
- Warning/indicator lamp**
 ABS warning lamp..... 428
 Active Brake Assist warning lamp..... 431
 ATTENTION ASSIST warning lamp..... 430
 Brakes warning lamp (Canada only)..... 427
-  Brakes warning lamp (USA only)... 427
-  Brakes warning lamp (yellow) (Canada only)..... 426
-  Check Engine warning lamp..... 423
-  Coolant warning lamp (red)..... 421
-  Coolant warning lamp (yellow)..... 423
-  Distance warning lamp..... 430
-  Electric parking brake indicator lamp (red) (Canada only)..... 425
-  Electric parking brake indicator lamp (red) (USA only)..... 425
-  Electric parking brake indicator lamp (yellow)..... 425
-  Electrical malfunction warning lamp..... 423
-  Engine operating temperature warning lamp..... 424
-  ESP® OFF warning lamp..... 429
-  ESP® warning lamp flashes..... 428
-  ESP® warning lamp lights up..... 429

-  Fuel reserve warning lamp flashes..... 424
-  Fuel reserve warning lamp lights up..... 424
-  Mercedes-Benz emergency call system warning lamp..... 431
-  Occupant presence reminder warning lamp (white)..... 419
-  Occupant presence reminder warning lamp (yellow)..... 419
-  Power steering warning lamp (red)..... 420
-  Power steering warning lamp (yellow)..... 420
-  RBS warning lamp (USA only)..... 426
-  Reduced warning lamp power..... 420
-  Restraint system warning lamp.... 418
-  Seat belt warning lamp flashes.... 418
-  Seat belt warning lamp lights up... 419
-  Tire pressure monitoring system warning lamp flashes..... 432
-  Tire pressure monitoring system warning lamp lights up..... 432
-  Traffic Sign Assist warning lamp... 430
- Warning/indicator lamps**
 - Driver's display..... 415
 - PASSENGER AIR BAG..... 46
- Washer fluid**
 - Topping up..... 288
 - Windshield washer fluid..... 361
- Washing by hand**..... 292
- Water tank**..... 289
- Wear**
 - Limited protection..... 52
- Weather information**..... 256
- Web browser**..... 269
- Weight information**..... 354
- Wheel change**
 - Installing a new wheel..... 348
 - Lowering the vehicle..... 349
- Removing a wheel..... 347
- Removing/installing hub caps..... 344
- Removing/installing wheel trim..... 344
- Wheel rotation**..... 343
- Wheels**
 - Breakdown..... 301
 - Care..... 294
 - Checking..... 321
 - Checking the tire pressure manually..... 325
 - Checking the tire temperature..... 326
 - Composition of the tire..... 335
 - Definitions..... 338
 - DOT, Tire Identification Number (TIN)..... 333
 - Installing..... 348
 - Load index..... 335
 - Load-bearing capacity..... 335
 - Maximum tire load..... 334
 - Maximum tire pressure..... 335
 - MOExtended..... 302
 - Noise..... 321
 - Notes on installing..... 340
 - Removing..... 347
 - Removing/installing hub cap..... 344
 - Removing/installing wheel trim..... 344
 - Replacing..... 340, 344

- Rotating..... 343
- Selecting..... 340
- Size designation..... 335
- Snow chains..... 322
- Speed rating..... 335
- Storing..... 343
- Temperature grade..... 332
- Tire and Loading Information placard..... 328
- Tire labeling..... 332
- Tire pressure..... 322
- Tire pressure monitor..... 325
- Tire Quality Grading..... 332
- TIREFIT kit..... 303
- Traction grade..... 332
- Tread wear grade..... 332
- Unusual handling characteristics..... 321
- Wi-Fi**
 - Setting up a hotspot..... 246
- Widescreen cockpit driver's display**
 - Instrument cluster..... 12
- Window curtain air bag**..... 57
- Windows**
 - Care..... 294
 - Convenience opening..... 88
 - Opening with the SmartKey..... 88
 - Opening/closing..... 86
 - Removing mist..... 139
 - Window films..... 294
- Windshield**
 - Defrosting..... 137
- Windshield washer fluid**..... 361
- Windshield washer system**..... 288
- Windshield wipers**
 - Activating/deactivating..... 131
 - Replacing the wiper blades..... 132
 - Replacing the wiper blades (windshield)..... 132
- Winter operation**
 - Snow chains..... 322
- Wiper blades**
 - Care..... 294
 - Replacing (windshield)..... 132
- Wipers**..... 131
- Wireless charging**
 - Mobile phone..... 123
 - Notes..... 122
- Workshop**..... 32



