



Digital – in the vehicle

Explore the Operator's Manual in the multimedia system under Preferences. Begin with Quick Start and discover useful tips.



Vehicle document wallet

This contains a physical copy of comprehensive information about operating your vehicle and about services and your vehicle's warranty



2065846808

Order no. P206 0577 13 Part no. 206 584 68 08
Edition A-2025

C-Class Sedan



C-Class Sedan

Operator's Manual

Mercedes-Benz

Mercedes-Benz



Front passenger air bag warning

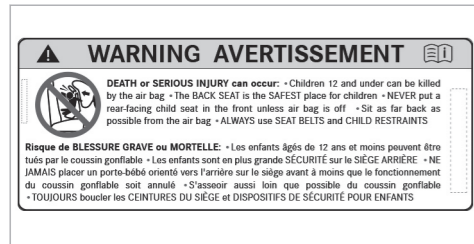
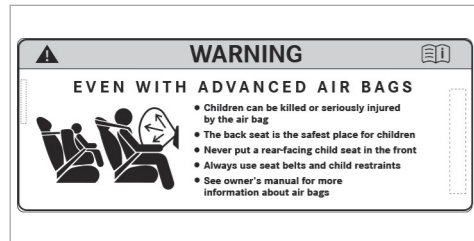

Air bag warning sticker for USA and Canada

WARNING Risk of injury or fatal injuries if the front passenger air bag is enabled

If the front passenger air bag is enabled, a child on the front passenger seat may be struck by the front passenger air bag in the event of an accident.

▶ NEVER use a rearward-facing child restraint system on a seat with an ENABLED FRONT AIR BAG. This can result in the DEATH of or SERIOUS INJURY to the CHILD.

Observe the chapter "Children in the vehicle".

Publication details

Website

Further information about Mercedes-Benz vehicles and about Mercedes-Benz AG can be found on the following websites:

<https://www.mbusa.com> (USA only)

<https://www.mercedes-benz.ca> (Canada only)

Editorial team

© Mercedes-Benz AG: Not to be reprinted, translated or otherwise reproduced, in whole or in part, without written permission from Mercedes-Benz AG.

Vehicle manufacturer

Mercedes-Benz AG
Mercedesstraße 120
70372 Stuttgart, Germany

Welcome to the world of Mercedes-Benz

Before your first drive, please read this Operator's Manual carefully and familiarize yourself with your vehicle. For your own safety and a longer service life for the vehicle, follow the instructions and warning notes in this Operator's Manual. Failure to do so may lead to personal injury or damage to the vehicle.

Vehicle damage caused by failure to observe the instructions is not covered by the Mercedes-Benz Limited Warranty.

The standard equipment and product description of your vehicle may vary and depends on the following factors:

- Model
- Order
- National version
- Availability

In individual cases, your vehicle may therefore differ from that shown in the descriptions and illustrations.

Mercedes-Benz reserves the right to introduce changes in the following areas:

- Design
- Equipment
- Technical features

The following documents are components of the vehicle:

- Digital Operator's Manual
- Printed Operator's Manual
- Maintenance Booklet (USA only)
- Supplementary manuals relating to specific equipment
- Supplementary documents

Keep these documents in the vehicle at all times. Ensure that all documents are in the vehicle or passed on in the event of sale or rental.

The latest information on service and warranty, along with a digital copy of this Operator's Manual, can be found on the following website.

USA only:

<https://www.mbusa.com/en/vehicle-information>

Canada only:

<https://www.mercedes-benz.ca/en/owners/manuals> (English)

<https://www.mercedes-benz.ca/fr/owners/manuals> (French)

Mercedes-Benz USA, LLC

Mercedes-Benz Canada, Inc.

A Mercedes-Benz Group AG Company

Symbols	5	National information for components relevant to radio regulation	30	Children in the vehicle	58
At a glance	6	Diagnostics connection	30	Key facts in brief	58
Cockpit	6	Qualified specialist workshop	31	Important safety notes	58
Cockpit (plug-in hybrid)	8	Correct use of the vehicle	32	Suitable child restraint systems for the transport of children	64
Indicator and warning lamps	10	Notes for persons with electronic medical aids	32	Securing the child restraint system	64
Overhead control panel	14	Problems with your vehicle	33	Child safety locks	70
Door operating unit and seat adjustment	16	Reporting safety defects	33	Occupant presence reminder	72
Emergencies and breakdowns	18	Limited Warranty	34	Opening and closing	73
Digital Operator's Manual	20	QR code for rescue card	34	SmartKey	73
Calling up the Digital Operator's Manual	20	Data storage	34	Digital Vehicle Key	77
General notes	21	Copyright	39	Doors	79
Protecting the environment	21	Occupant safety	40	Trunk	84
Mercedes-Benz GenuineParts	22	Brief overview of the most important points	40	Side windows	90
Operator's Manual	23	Information on the automatic functions of the restraint system	48	Sliding sunroof	93
Touch-sensitive controls	23	Purpose and function of the restraint system	51	Roller sun blinds	97
Mercedes me App	24	Seat belts	56	Anti-theft protection	98
Service and vehicle operation	24	Airbags	57	Seats and stowing	102
Operating safety	26			Notes on the correct driver's seat position ..	102
Installing the license plate on the front license plate bracket	29			Notes on grab handles	102
				Seats	103
				Steering wheel	113

Easy entry and exit feature	116	DYNAMIC SELECT	192	MBUX multimedia system	303
Memory function	118	Automatic transmission	196	Overview and operation	303
Stowage areas	119	Function of 4MATIC	201	System settings	319
Cup holder	131	Refueling	201	AMG TRACK PACE	324
Ashtray and cigarette lighter	134	Charging the high-voltage battery (plug-in hybrid)	204	Plug-in hybrid settings	329
Sockets	135	Parking	220	Off-road menu	331
Wireless charging of the mobile phone and connection with the exterior antenna	137	Driving and driving safety systems	229	Navigation and traffic	332
Installing/removing the floor mats	138	Vehicle towing instructions	294	Telephone	343
Light and visibility	140	Driver's display	295	Mercedes me Apps	347
Exterior lighting	140	Notes on the driver display	295	Mercedes-Benz emergency call system	353
Interior lighting	150	Driver display malfunction	295	Radio & media	357
Windshield wiper and windshield washer system	152	Operating the driver display	296	Sound settings	361
Mirrors	155	Driver display menus	297		
Climate control	159	Head-up Display	298	Maintenance and care	362
Overview of climate control systems	159	Vehicles with a 48 V on-board electrical system	300	ASSYST PLUS service interval display	362
Operating the climate control system	161	Function of the power meter (plug-in hybrid vehicles)	300	Maintenance Management	363
Driving and parking	172	Overview of status indicators on the driver display	301	Telediagnosis	363
Driving	172			Engine compartment	364
				Cleaning and care	370
				Breakdown assistance	380
				Emergency	380
				Flat tire	382
				Battery (vehicle)	389

4 Contents

Tow starting or towing away	396
Electrical fuses	402

Wheels and tires

Wheels and tires	405
Notes on noise or unusual handling characteristics	405
Notes on regularly inspecting wheels and tires	405
Notes on snow chains	406
Tire pressure	406
Loading the vehicle	413
Tire labeling	417
Definition of terms for tires and loading	423
Changing a wheel	425
Emergency spare wheel	435

Technical data

Technical data	437
Notes on technical data	437
Vehicle electronics	437
Radio regulations	439
Vehicle identification plate, VIN and engine number overview	439
Operating fluids	441
Vehicle data	448

Display messages and warning/indicator

lamps	449
Display messages	449
Warning and indicator lamps	525

Index

545

In this Operator's Manual, you will find the following symbols:

 **WARNING** Danger due to failure to observe the warning notices

Warning notices draw your attention to hazards that may endanger your health or life, or the health or life of others.

 Observe the warning notices.

 **ENVIRONMENTAL NOTE** Environmental damage due to failure to observe environmental notes

Environmental notes include information on environmentally responsible behavior or environmentally responsible disposal.

 Observe environmental notes.

 **NOTE** Damage to property due to failure to observe notes on material damage

Notes on material damage inform you of risks which may lead to your vehicle being damaged.

 Observe notes on material damage.

 These symbols indicate useful instructions or further information that could be helpful to you.

 Instruction

(→ page) Further information on a topic

Display Display in the central display







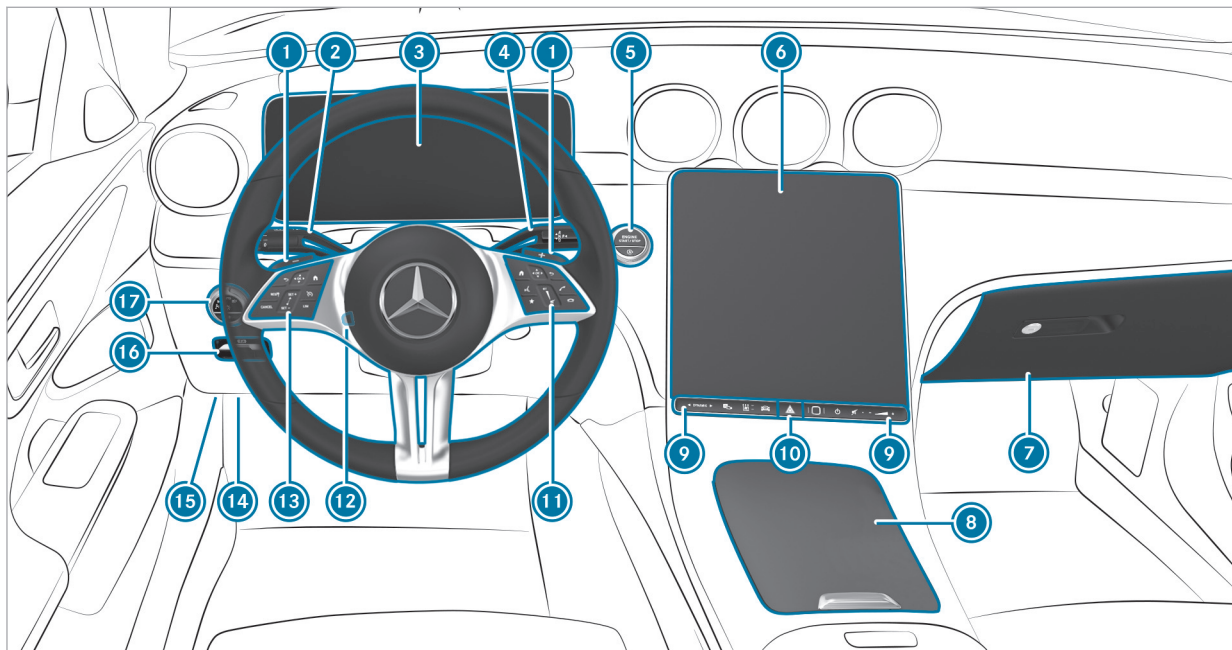





 Highest menu level, which is to be selected in the multimedia system

 Relevant submenus, which are to be selected in the multimedia system

* Indicates a cause







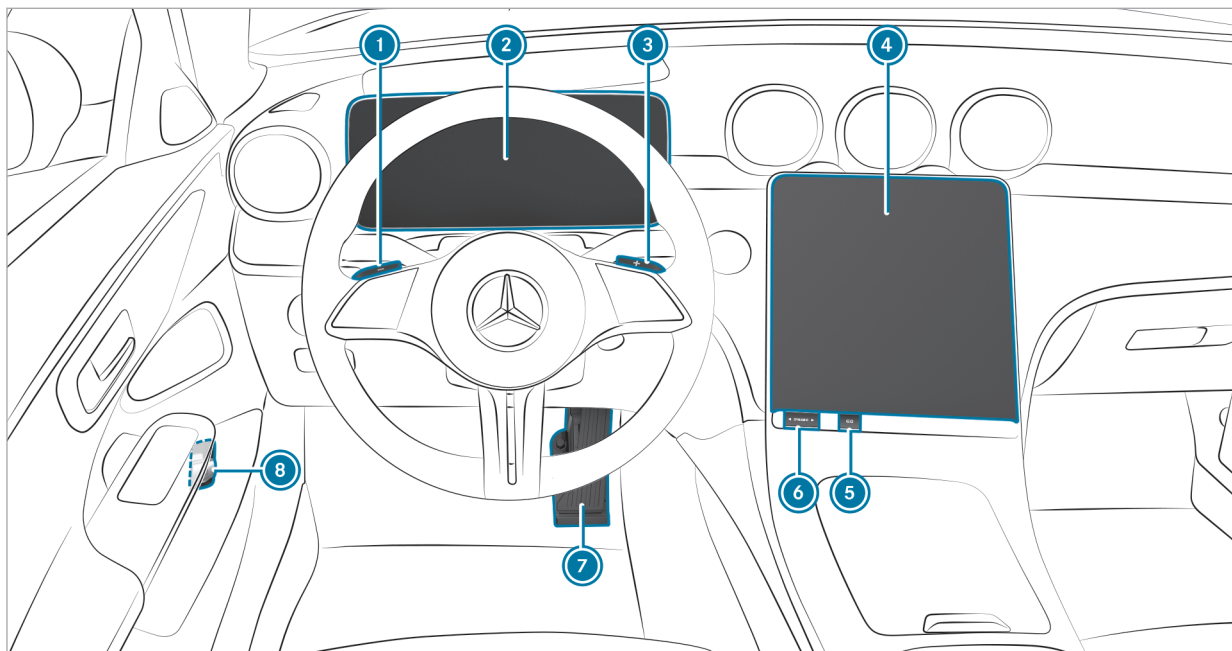

Left-hand drive vehicles

1	Steering wheel paddle shifters	→	199		Switches sound on/off	→	304
2	Combination switch	→	141		Adjusts the volume	→	304
3	Driver's display	→	296	10 	Hazard warning light system	→	142
4	DIRECT SELECT lever	→	196	11	Control panel for the MBUX multimedia system	→	310
5	 Start/stop button	→	176	12	Adjusts the steering wheel	→	114
	 ECO start/stop function	→	186		Switches the steering wheel heater on/off	→	115
6	Central display	→	304	13	Control panel:		
7	Glove box	→	122		Driver's display	→	296
8	Stowage compartment	→	122		Cruise control	→	237
9	Switch panel for:				Active Distance Assist DISTRONIC	→	241
	 DYNAMIC SELECT button	→	194	14	Diagnostics connection	→	30
	 Active Parking Assist	→	283	15	Opens the hood	→	364
	 Quick vehicle access			16	 Electric parking brake	→	225
	 Fingerprint sensor	→	304	17	Light switch	→	140
	 Switches the MBUX multimedia system on/off	→	304				



Left-hand-drive vehicles







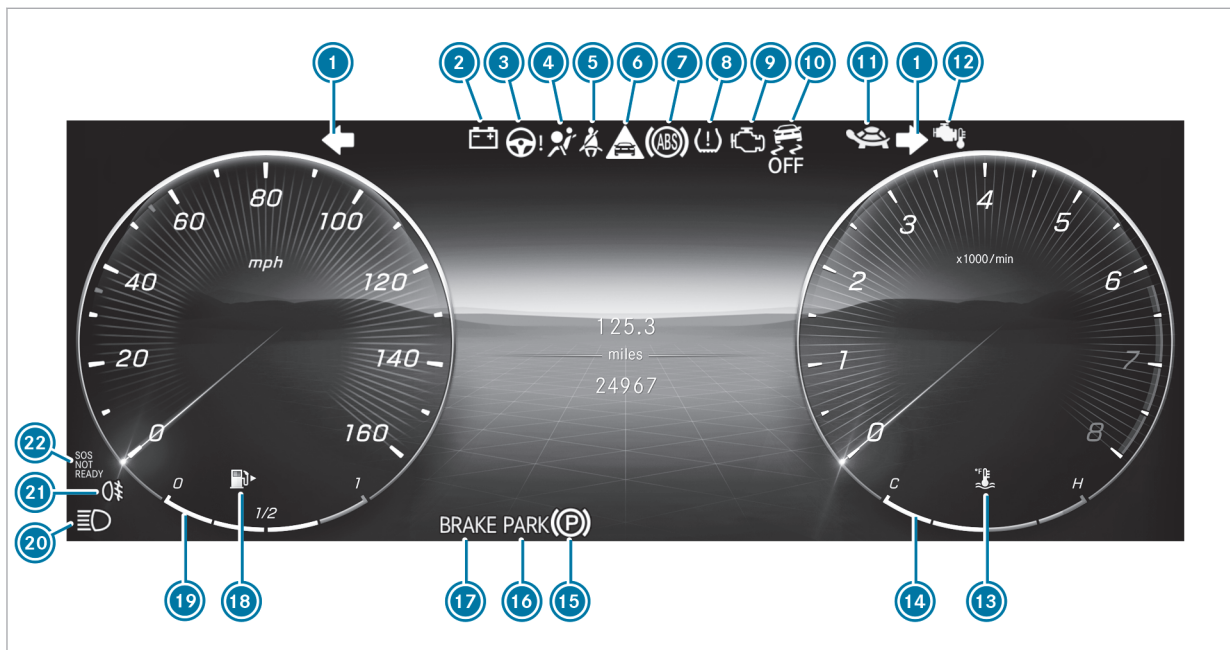





















①	 Increases recuperation	→	189
②	Driver display:		
	 Operational readiness	→	301
	Trip computer		
	ECO Assist	→	190
③	 Reduces recuperation	→	189
④	Central display:		

	Plug-in hybrid settings	→	329
	Energy flow display	→	330
⑤	Sets charging times	→	329
⑥	 DYNAMIC SELECT button	→	192
⑦	 Haptic accelerator pedal	→	192
⑧	 Depressurizes and refills the fuel tank	→	204

10 At a glance - Indicator and warning lamps



Driver display

1		Turn signal lights	→	141
2		Electrical malfunction	→	531
3		Power steering (red)	→	530
		Power steering (yellow)	→	530
		Rear-axle steering (yellow)	→	530
4		Restraint system	→	527
5		Seat belt	→	527
6		Distance warning	→	539
7		ABS	→	539
8		Tire pressure monitor	→	543
9		Engine diagnostics	→	531
10		ESP® OFF	→	539
		ESP®	→	539
11		Drive system: reduced power	→	529
12		Gasoline engine: reduced power	→	531
13		Coolant temperature	→	531
14		Coolant temperature display		
15		Electric parking brake (yellow)	→	536
16		Electric parking brake (red)	→	536
		USA only		
		Canada only		
17		Brakes (red)	→	536
		USA only		
		Canada only		
		Recuperative Brake System, USA only	→	536
		Brakes (yellow), Canada only	→	536
18		Reserve fuel with fuel filler flap location indicator	→	531
19		Fuel level		
20		High beam	→	141
		Low beam	→	140
		Parking lamps	→	140

12 At a glance - Indicator and warning lamps

21  Rear fog light



141

22  Mercedes-Benz emergency call system







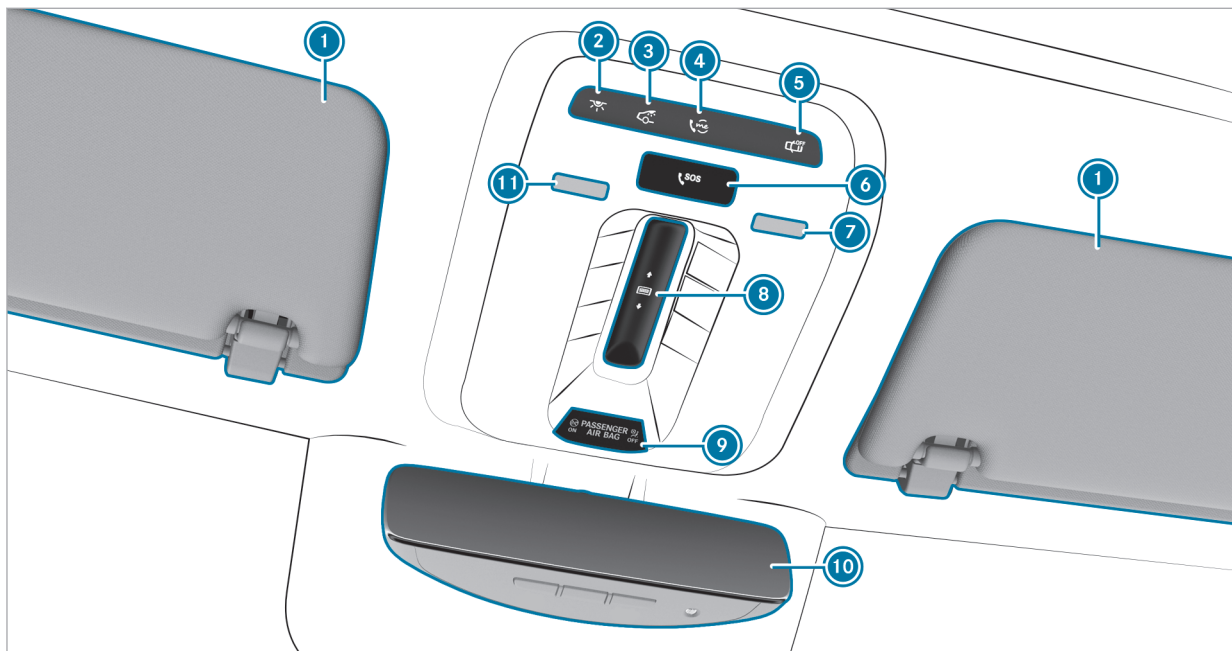

543











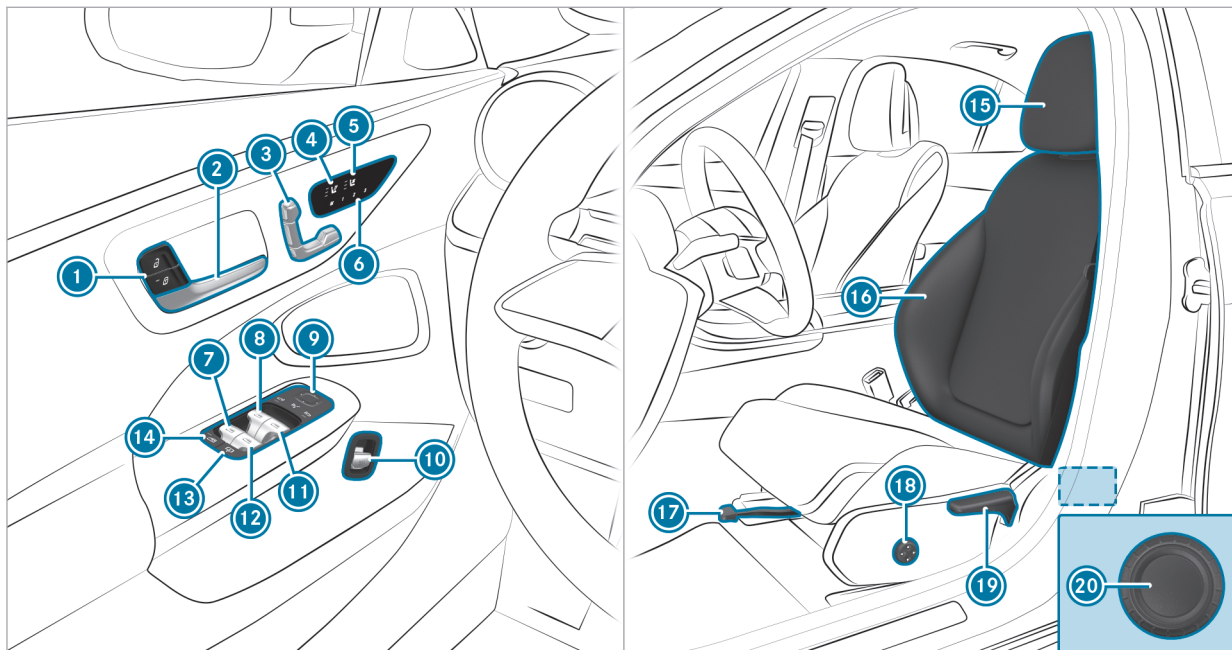





14 At a glance - Overhead control panel





①	Sun visors (folding, available in extendable design as an optional extra)		
②	 Switches the front interior lighting on/off	→	150
③	 Switches the rear interior lighting on/off	→	150
④	 me button	→	347
⑤	 Switches automatic interior lighting control on/off	→	150
⑥	 SOS button	→	347
⑦	Switches the right-hand reading lamp on/off	→	150
⑧	 Opens/closes the panorama roof with power tilt/sliding panel	→	93
	 Opens/closes the panorama roof with power tilt/sliding panel roller sunblind	→	93
⑨	PASSENGER AIR BAG indicator lamp	→	45
⑩	Inside rear-view mirror	→	157
⑪	Switches the left-hand reading lamp on/off	→	150

16 At a glance - Door operating unit and seat adjustment

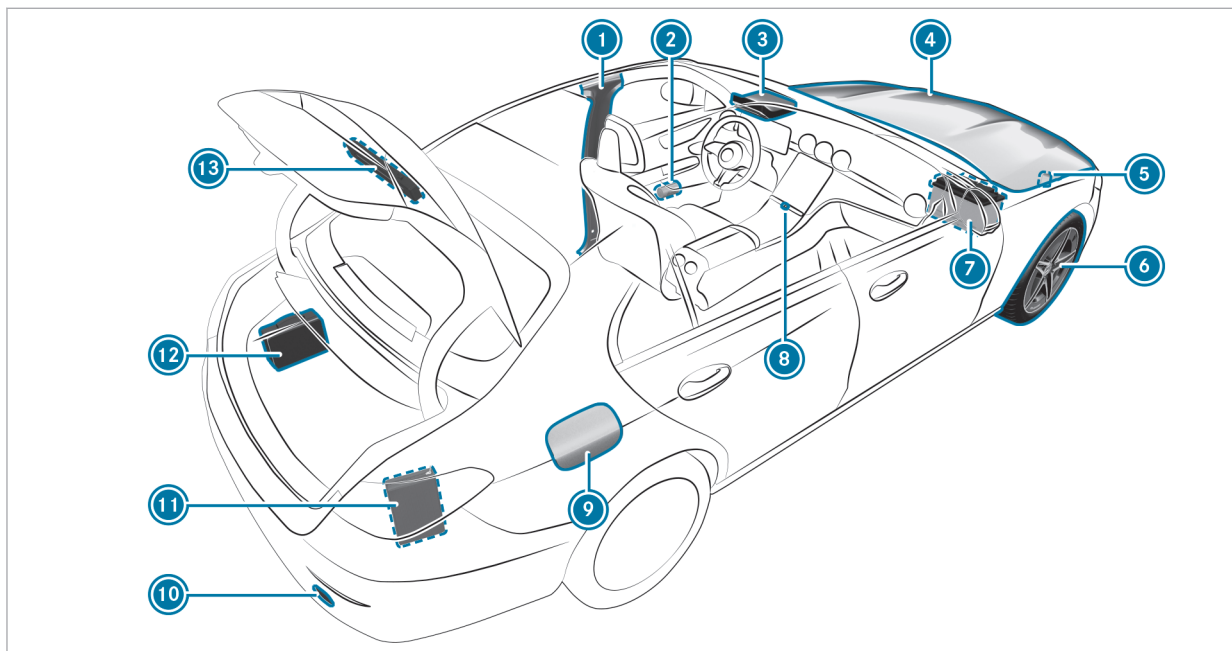

1	 	Locks/unlocks the vehicle	→	80	12		Opens/closes the rear right side window	→	90
2		Opens the door	→	79	13		Rear window roller sunblind	→	98
3		Adjusts the seats electrically	→	105	14		Child safety lock for the rear side windows	→	72
4		Switches the seat heating on/off	→	112	15		Adjusts the head restraints	→	108
5		Switches the seat ventilation on/off	→	113	16		Seat adjustment using the multimedia system	→	110
6		Operates the memory function	→	119	17		Adjusts the seat fore-and-aft position	→	103
7		Opens/closes the rear left side window	→	90	18		Adjusts the 4-way lumbar support	→	107
8		Opens/closes the left side window	→	90	19		Adjusts the seat height	→	103
9		Operates the outside mirrors	→	155	20		Adjusts the seat backrest inclination	→	103
10		Opens/closes the trunk lid	→	84					
11		Opens/closes the right side window	→	90					



1	B-pillar with:		
	QR code for accessing the rescue card	→	34
2	Safety vests	→	380
3	 me button	→	347
	 SOS button	→	347
4	To check and top up operating fluids	→	441
5	Tow-starting or towing away	→	398
6	Flat tire	→	382
7	Jump-starting	→	394

8	 Hazard warning light system	→	142
9	Fuel filler flap with:		
	information label on fuel type	→	201
	information label on tire pressure	→	408
	QR code for accessing the rescue card	→	34
10	Tow-starting or towing away	→	398
11	First-aid kit (soft sided)	→	381
12	TIREFIT kit	→	384
13	Warning triangle	→	381

Calling up the Digital Operator's Manual

Multimedia system:

→ [Home] ▶ Settings ▶ Info

▶▶ Operator's Manual

▶▶ Open Digital Operator's Manual

The Digital Operator's Manual describes the functions and operation of the vehicle and the multimedia system.

▶ Select one of the following menu items in the Digital Operator's Manual:

- **Quick start:** find the first steps towards adjusting your seat (driver's side).
- **Tips:** find information that prepares you for certain everyday situations with your vehicle.
- **Animations:** watch animations of the vehicle functions.
- **Messages:** receive additional information about the messages on the driver display.
- **Language:** select the language for the Digital Operator's Manual.

You can search for keywords using the search field **Search** in order to find quick answers to questions regarding operation of the vehicle.

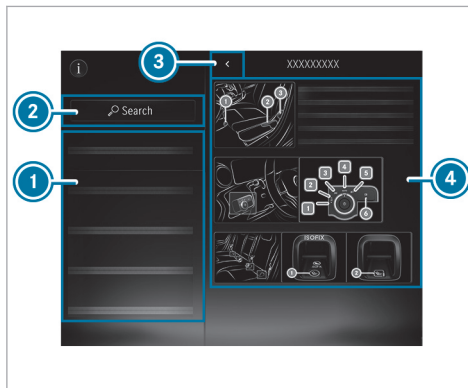

- 1 Menu
- 2 Search
- 3 Back
- 4 Contents section

Some sections in the Digital Operator's Manual, such as warning notes, can be expanded and collapsed.

Additional options for calling up the Digital Operator's Manual:

Driver display: call up brief information regarding display messages on the driver display. Pressing ⓘ will show brief information on the central display.

MBUX Voice Assistant: call-up via the voice control system

ⓘ For safety reasons, the Digital Operator's Manual is deactivated while you are driving.

Protecting the environment

 **ENVIRONMENTAL NOTE** Environmental damage due to operating conditions and personal driving style

The pollutant emission of the vehicle is directly related to the way you operate the vehicle.

Operate your vehicle in an environmentally responsible manner to help protect the environment. Please observe the following recommendations on operating conditions and personal driving style.

Operating conditions:

- ▶ Make sure that the tire pressure is correct.
- ▶ Do not carry any unnecessary weight (e.g. roof luggage racks once you no longer need them).
- ▶ Adhere to the service intervals. A regularly serviced vehicle will contribute to environmental protection.

- ▶ Always have maintenance work carried out at a qualified specialist workshop.

Personal driving style:

- ▶ Do not depress the accelerator pedal when starting the engine.
- ▶ Do not warm up the vehicle while stationary.
- ▶ Drive carefully and maintain a suitable distance from the vehicle in front.
- ▶ Avoid frequent, sudden acceleration and braking.
- ▶ Change gear in good time and use each gear only up to $\frac{2}{3}$ of its maximum engine speed.
- ▶ Switch off the vehicle in stationary traffic, e.g. by using the ECO start/stop function.
- ▶ Drive in a fuel-efficient manner. Observe the ECO display for an economical driving style.

Plug-in hybrid

 **ENVIRONMENTAL NOTE** Environmental pollution caused by irresponsible disposal of the high-voltage battery

A high-voltage battery contains materials which are harmful to the environment.

- ▶ Dispose of defective high-voltage batteries at a qualified specialist workshop.

Environmental issues and recommendations:

It is recommended that you re-use or recycle materials instead of just disposing of them.

The relevant environmental guidelines and regulations serve to protect the environment and must be strictly observed.

Mercedes-Benz GenuineParts



ENVIRONMENTAL NOTE Environmental damage due to not using recycled reconditioned components

Mercedes-Benz AG offers recycled reconditioned components and parts with the same quality as new parts. The same entitlement from the Limited Warranty is valid as for new parts.

- ▶ Use recycled reconditioned components and parts from Mercedes-Benz AG.

NOTE Impairment of the operating efficiency of the restraint systems from installing accessory parts or from repairs or welding

Air bags and Emergency Tensioning Devices, as well as control units and sensors for the restraint systems, may be installed in the following areas of your vehicle:

- doors

- door pillars
- sill
- seats
- cockpit
- driver's display
- center console
- lateral roof frame

- ▶ Do not install accessory parts such as audio systems in these areas.
- ▶ Do not carry out repairs or welding.
- ▶ Have accessories retrofitted at a qualified specialist workshop.

You could jeopardize the operating safety of your vehicle if you use parts, tires and wheels, as well as accessories relevant to safety that have not been approved by Mercedes-Benz. Safety-critical systems (e.g. the brake system) may malfunction. Use only Mercedes-Benz GenuineParts or parts of equal quality. Use only tires, wheels and accessory parts that have been specifically approved for your vehicle model.

Mercedes-Benz GenuineParts are subject to strict quality inspections. Each part has been specially developed, manufactured or selected for Mercedes-Benz vehicles and adapted to them. Therefore, only Mercedes-Benz GenuineParts should be used.

More than 300,000 different Mercedes-Benz GenuineParts are available for Mercedes-Benz models.

All Mercedes-Benz Service Centers maintain a supply of Mercedes-Benz GenuineParts for necessary service and repair work. In addition, strategically located parts delivery centers ensure quick and reliable parts service.

Always specify the vehicle identification number (VIN) (→ page 439) when ordering Mercedes-Benz GenuineParts.

Operator's Manual

This Operator's Manual and the Digital Operator's Manual in the vehicle describe the following models and the standard and special equipment for your vehicle:

- The models and the standard and special equipment available at the time of this Operator's Manual going to press.
- The models and the standard and special equipment available only in certain countries.
- The models and the standard and special equipment that will become available only at a later date.

Please note that your vehicle may not be equipped with all features described. This also applies to systems relevant to safety. The equipment on your vehicle may therefore differ from that in the descriptions and illustrations.

The original purchase agreement for your vehicle includes a list of the equipment in your vehicle at the time of delivery.

Should you have any questions concerning equipment and operation, please consult an authorized Mercedes-Benz Center.

- ⓘ Please bear in mind that all the speed figures stated in this Operator's Manual are approximate and are subject to a certain tolerance.

The Operator's Manual, Supplement, further supplementary documents and Maintenance Booklet (USA only) are important documents and should be kept in the vehicle.

Touch-sensitive controls

In addition to conventional switches and buttons, your vehicle is equipped with touch-sensitive controls.

These are located in the following areas of your vehicle:

- Roof and door control panel
- Climate control
- Steering wheel
- MBUX multimedia system

The controls have touch-sensitive user interface surfaces. You can control these surfaces by pressing or swiping to adjust settings or to trigger functions, for example.

The touch-sensitive user interface on the central display also provides haptic feedback in the form of pulses, vibrations or changes in the surface structure, for example.

The haptic feedback from the user interface of the central display is produced using ultrasound.

When using the haptic controls on the central display, ensure that there is sufficient distance between the head and the display surface during operation.

You will receive haptic feedback in the following situations, for example:

- When you interact with controls on the display surface
- When scrolling in a list or table
- When you reach a new area on the display surface, e.g. a pop-up window, controls, icons

Despite careful development, Mercedes-Benz AG cannot completely rule out the possibility of exter-

nal microphones interfering with the haptic controls.

If you have any questions, contact a qualified specialist workshop.

When using touch-sensitive user interfaces, note the following points to avoid problems:

- Do not affix stickers or similar objects to the surfaces.
- Do not attach smartphone holders or other mountings to the surface of the central display.
- Keep the surfaces protected from moisture and wet conditions.
- Keep the surfaces free of dust and dirt (→ page 377).

Some touch-sensitive controls have both a symbol and integrated indicator lamps. Be sure to press on the symbol of the control element when using it.

Mercedes me App

Notes about the on-demand feature

You can also activate various functions (on-demand feature) subsequently via Mercedes me after purchasing your vehicle.

Information is available at any authorized Mercedes-Benz Center.

Activating on-demand feature using Mercedes me

Requirements

- The vehicle has a wireless connection.
- The vehicle is linked to the Mercedes me user account.

Ordering and activating on-demand feature

- ▶ Add the desired on-demand feature for the vehicle to the shopping basket in the Mercedes me Store.
- ▶ Complete the order.
The on-demand feature is activated when operating the vehicle.

Speeding up activation

- ▶ Switch the vehicle off and lock it.
- ▶ Unlock the vehicle after about two minutes and switch on the vehicle.
The on-demand feature has been activated. For some features, a notification system also appears in the vehicle's multimedia system.

If the activation was not successful, repeat the process.

Service and vehicle operation

Vehicle operation outside the USA or Canada

When you are abroad with your vehicle, observe the following points:

- service points or replacement parts may not be available immediately.
- unleaded fuel may not be available for vehicles with a catalytic converter. Leaded fuel may cause damage to the catalytic converter.

- the fuel may have an extremely low octane number. Unsuitable fuel can cause engine damage.

Some Mercedes-Benz models are available in Europe through our European Delivery Program. For more information, please consult a Mercedes-Benz service outlet, or write to one of the following addresses:

in the USA:

Mercedes-Benz USA, LLC
One Mercedes-Benz Drive
Sandy Springs, GA 30328

in Canada:

Mercedes-Benz Canada, Inc.
2680 Matheson Blvd E, Suite 500
Mississauga, ON L4W 0A5

Maintenance

USA only:

Your customer advisor confirms the service in the service report.

Roadside Assistance

The Mercedes-Benz Roadside Assistance Program offers technical help in the case of a breakdown. Your calls to the toll-free Roadside Assistance Hotline are answered by our agents 24 hours a day, 365 days a year.

1-800-FOR-MERcedes (1-800-367-6372) (USA)
1-800-387-0100 (Canada)

USA only: You can find further information in the Mercedes-Benz Roadside Assistance Program brochure.

Canada only: You can find further information in the "Roadside Assistance" section in the Warranty Information Guide. Please refer to Mercedes-Benz Canada's website:

<https://www.mercedes-benz.ca/en/owners/manuals> (English)

<https://www.mercedes-benz.ca/fr/owners/manuals> (French)

Change of address or change of ownership

In the event of a change of address, please send us the "Notification of address change" in the Service and Guarantee booklet or simply call the Mercedes-Benz Customer Assistance Center (USA) on the hotline number 1-800-FOR-MERcedes (1-800-367-6372) or Customer Service (Canada) on 1-800-387-0100. We can then reach you in a timely fashion, if necessary.

If you sell your Mercedes, please leave all literature in the vehicle so that it is available to the next owner. If you have purchased a used vehicle, please send us the "Notice of Purchase of Used Car" in the Service and Guarantee booklet or simply call the Mercedes-Benz Customer Assistance Center (USA) at the hotline number 1-800-FOR-MERcedes (1-800-367-6372) or Customer Service (Canada) at 1-800-387-0100.

Possible danger due to substances hazardous to health

In compliance with Proposition 65 ("Prop65"), the following detachable label has been added to each vehicle sold in California:



Operating safety

⚠ WARNING Risk of accident due to malfunctions or system failures

If you do not have the prescribed service/maintenance work or any required repairs car-

ried out, this could result in malfunctions or system failures.

- ▶ Always have the prescribed service and maintenance work or any required repairs carried out in a qualified specialist workshop.

⚠ WARNING Risk of accident or injury due to incorrect modifications on electronic component parts

Modification of electronic components, their software or wiring could impair their function and/or the function of other networked component parts or safety-relevant systems.

This can endanger the operating safety of the vehicle.

- ▶ Never tamper with the wiring and electronic component parts or their software.
- ▶ You should have all work on electrical and electronic components carried out at a qualified specialist workshop.

Observe the "On-board electronics" section in "Technical data".

⚠ WARNING Risk of fire caused by flammable material on hot exhaust system components

Flammable material such as leaves, grass or twigs may ignite if they come into contact with hot parts of the exhaust system.

- ▶ When driving on an unpaved road or off-road, check the vehicle underside regularly.
- ▶ In particular, remove trapped plant parts or other flammable material.
- ▶ If there is damage, consult a qualified specialist workshop immediately.

! **NOTE** Damage to the vehicle due to driving too fast and due to impacts to the vehicle underbody or suspension components

In the following situations, in particular, there is a risk of damage to the vehicle:

- The vehicle becomes grounded, e.g. on a high curb or an unpaved road
- The vehicle is driven too fast over an obstacle, e.g. a curb, speed bump or pothole
- A heavy object strikes the underbody or suspension components

In situations such as these, damage to the body, underbody, suspension components, wheels or tires may not be visible. Components damaged in this way can unexpectedly fail or, in the case of an accident, may no longer absorb the resulting force as intended.

If the underbody paneling is damaged, flammable materials such as leaves, grass or twigs can collect between the underbody and the

underbody paneling. These materials may ignite if they come into contact with hot parts of the exhaust system.

▶ Have the vehicle checked and repaired immediately at a qualified specialist workshop.

or

▶ If driving safety is impaired while continuing your journey, pull over and stop the vehicle immediately, while paying attention to road and traffic conditions, and contact a qualified specialist workshop.

Plug-in hybrid

Hybrid vehicles have a combustion engine and at least one electric motor. The energy supply for operating the vehicle electrically is provided by the vehicle's high-voltage electrical system.

! **DANGER** Risk of death and fire due to modified and/or damaged components of the high-voltage on-board electrical system

The vehicle's high-voltage on-board electrical system is under high voltage. If you modify component parts in the vehicle's high-voltage on-board electrical system or touch damaged component parts, you may be electrocuted. In addition, modified and/or damaged components may cause a fire.

In the event of an accident or impact to the underbody, components of the high-voltage electrical system may be damaged although the damage is not visible.

▶ Never make any modifications to the high-voltage on-board electrical system.

▶ Do not switch on or use the vehicle if its high-voltage on-board electrical system components have been modified or damaged.

- ▶ Never touch damaged components of the high-voltage on-board electrical system.
- ▶ After an accident, do not touch any components of the high-voltage on-board electrical system.
- ▶ After an accident, have the vehicle transported away.
- ▶ Have the components of the high-voltage on-board electrical system checked at a qualified specialist workshop and replaced if necessary.

The components of the vehicle's high-voltage on-board electrical system are marked with yellow warning stickers. The cables of the vehicle's high-voltage on-board electrical system are orange in color.

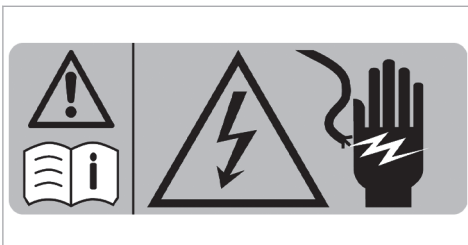

Example

High-voltage components that can become very hot are marked with an additional warning sticker:



Vehicles with hybrid systems generate significantly less noise when stationary and when being driven compared with vehicles that have combustion engines.

When you are driving in electric mode, the vehicle may not be heard by other road users due to the significantly reduced noise generated when driving and when stationary.

It is for this reason that the vehicle is equipped with a sound generator, which serves as an acoustic vehicle alerting system (AVAS). This safety system is prescribed by law.

The external noise produced by the sound generator (AVAS) can be heard in the passenger compartment at low speeds and does not represent a malfunction.

Vehicles with a 48 V on-board electrical system

⚠ DANGER Risk of fatal injury by touching damaged high-voltage components

Vehicles with a 48 V on-board electrical system contain individual high-voltage compo-

nents. These high-voltage components are under high voltage.

If you modify component parts of these high-voltage components or touch damaged component parts, you may be electrocuted.

High voltage components may be damaged in an accident, although the damage may not be visible.

- ▶ Never perform modifications to component parts of high-voltage components.
- ▶ Never touch damaged component parts of high-voltage components.
- ▶ Never touch component parts of high-voltage components after an accident.

Vehicles with a 48 V on-board electrical system contain high-voltage components. These components are marked with a high-voltage label:

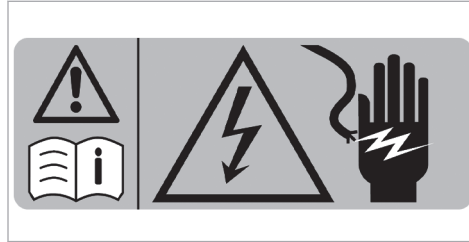

Example

All work on high-voltage components must be carried out at a qualified specialist workshop.

Installing the license plate on the front license plate bracket

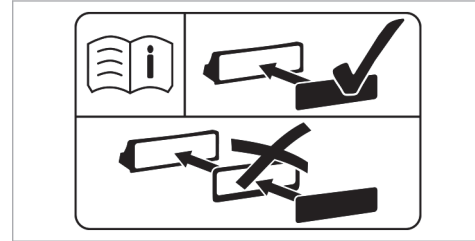

The information label can be found on the license plate bracket, either embossed or in sticker form.

! **NOTE** Malfunctions and system failures due to incorrect mounting of the license plate on the front license plate holder

If the license plate is incorrectly mounted on the front license plate holder, sensors, cameras or driving and safety systems may malfunction or fail.

Observe the following points when mounting the license plate on the front license plate holder:

- ▶ Mount the license plate directly on the license plate holder without advertising media or other holders.
- ▶ Mount the license plate so that it does not protrude above or to the side of the license plate adapter.

National information for components relevant to radio regulation

Information on crossing national borders

You must observe the radio regulations for the country in which you are currently operating your vehicle.

Wireless vehicle components



USA: "Radio based devices of this vehicle comply with Part 15 of the FCC Rules. Operation is subject to the following two conditions: 1) These devices may not cause harmful interference, and 2) These devices must accept any interference received, including interference that may cause undesired operation. Changes or modifications not expressly approved by the party responsible for compliance could void the user's authority to operate the equipment."

Canada: "This vehicle contains licence-exempt transmitter(s)/receiver(s) that comply with Innovation, Science and Economic Development Canada's licence-exempt RSS(s). Operation is subject to the following two conditions: (1) These devices may not cause interference. (2) These devices must accept any interference, including interference that may cause undesired operation of the devices." "Les émetteurs/récepteurs dans ce véhicule sont conformes aux CNR d'Innovation, Sciences et Développement économique Canada applicables aux appareils radio exempts de licence. L'exploitation est autorisée aux deux conditions suivantes : 1) Ces appareils ne doivent pas produire de brouillage; 2) Ces appareils doivent

accepter tout brouillage radioélectrique subi, même si le brouillage est susceptible d'en compromettre le fonctionnement."

Diagnostics connection

The diagnostics connection is a technical interface in the vehicle. It is used, for example, in the context of repair and maintenance work or for reading out vehicle data in a specialist workshop. Diagnostic devices should therefore only be connected in a qualified specialist workshop.

⚠ WARNING Risk of accident due to connecting devices to the diagnostics connection

If you connect devices to the diagnostics connection of the vehicle, the function of vehicle systems and operating safety may be impaired.

- ▶ For safety reasons, we recommend that you use and connect only products approved by an authorized Mercedes-Benz Service Center.

⚠ WARNING Risk of accident due to objects in the driver's footwell

Objects in the driver's footwell may impede pedal travel or block a depressed pedal.

This will jeopardize the operating- and road safety of the vehicle.

- ▶ Stow all objects in the vehicle securely so that they cannot get into the driver's footwell.
- ▶ Make sure that there is always sufficient clearance for the pedals.
- ▶ Always install the floor mats securely and as prescribed.
- ▶ Do not use loose floor mats and do not place floor mats on top of one another.

! NOTE Battery discharging from using devices connected to the diagnostics connection

Using devices at the diagnostics connection drains the battery.

- ▶ Check the charge level of the battery.
- ▶ If the charge level is low, charge the battery, e.g. by driving a considerable distance.

Please also observe the notes on the 12 V battery and on short-distance trips in the chapter "Driving and Parking" (→ page 181).

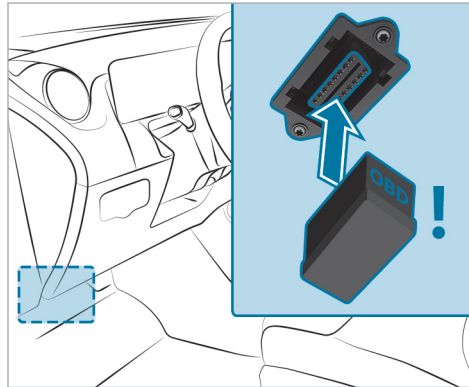

Connecting and using another device with the diagnostics connection can have the following effects:

- Malfunctions in the vehicle system
- Permanent damage to vehicle components

Please refer to the warranty terms and conditions for this matter.

Moreover, connecting equipment to the diagnostics connection can lead to emissions monitoring information being reset, for example. This may lead to the vehicle failing to meet the requirements of the next emissions inspection during the main inspection.

Qualified specialist workshop

A Mercedes-Benz Service Center is a qualified specialist workshop. It has the necessary special skills, tools and qualifications to correctly carry out the work required on your vehicle. This particularly applies to safety-relevant work.

Always have the following work on your vehicle carried out at a Mercedes-Benz Service Center:

- Safety-relevant work
- Service- and maintenance work
- Repair work
- Modifications as well as installations- and conversions
- Work on electronic components
- **Plug-in hybrid:** Work on the hybrid drive system
- **Vehicles with 48 V on-board electrical system:** Work on the high-voltage components of the 48 V on-board electrical system

Mercedes-Benz recommends a Mercedes-Benz Service Center.

Correct use of the vehicle

If you remove any warning stickers, you or others could fail to recognize certain dangers. Leave warning stickers in position.

Observe the following information in particular when driving your vehicle:

- the safety notes in this Operator's Manual, vehicle-specific supplements and further supplementary documents
- technical data for the vehicle
- traffic laws and regulations of the country you are currently driving in
- laws pertaining to motor vehicles and safety standards of the country you are currently driving in
- radio regulatory requirements of the country you are currently driving in

Notes for persons with electronic medical aids

Mercedes-Benz AG cannot, despite carefully developing vehicle systems, completely rule out the interaction of vehicle systems with electronic medical aids such as cardiac pacemakers.

In addition, there are components installed in the vehicle that, regardless of the operating status of the vehicle, can generate magnetic fields on a par

with permanent magnets. These fields can be found, for example, in the area around the multimedia and sound system or also in the area of the seats, depending on the vehicle equipment.

For this reason, the following can occur in isolated cases, depending on the aids used:

- Medical aids malfunctioning
- Adverse health effects

Observe the notes and warnings of the manufacturer of the medical aids; if in doubt, contact the device manufacturer and/or your doctor. If there is continuing uncertainty concerning the possibility of medical aids malfunctioning, Mercedes-Benz AG recommends using only few electrical vehicle systems and/or maintaining a distance from the components.

Plug-in hybrid

When charging the high-voltage battery, keep a distance of at least an arm's length between the medical aid and the following components:

- The power supply equipment

This includes charging stations in the form of a wallbox or a public charging point, for example.

- Vehicle components carrying live voltage

This includes the charging cable and the charging control box, for example.

Only have repairs and maintenance work in the area of the following components carried out at a qualified specialist workshop:

- Vehicle components carrying live voltage
- Transmission antenna
- Multimedia system and sound system

If you have any queries or suggestions, consult a qualified specialist workshop.

Problems with your vehicle

If you should experience any problem with your vehicle, particularly one that you believe may affect its safe operation, we urge you to contact a Mercedes-Benz Service Center immediately to have the problem diagnosed and rectified. If the

problem is not resolved to your satisfaction there, please contact a Mercedes-Benz Service Center again or write to one of the following addresses.

In the USA:

Mercedes-Benz USA, LLC
Customer Assistance Center
One Mercedes-Benz Drive
Sandy Springs, GA 30328

In Canada:

Mercedes-Benz Canada, Inc.
Customer Assistance Center
2680 Matheson Blvd E, Suite 500
Mississauga, ON L4W 0A5

Reporting safety defects

USA only:

The following text is published as required of manufacturers under Title 49, Code of U.S. Federal Regulations, Part 575 pursuant to the “National Traffic and Motor Vehicle Safety Act of 1966”.

If you believe that your vehicle has a defect which could cause a crash or could cause injury or death, you should immediately inform the National Highway Traffic Safety Administration (NHTSA) in addition to notifying Mercedes-Benz USA, LLC.

If NHTSA receives similar complaints, it may open an investigation, and if it finds that a safety defect exists in a group of vehicles, it may order a recall and remedy campaign. However, NHTSA cannot become involved in individual problems between you, your dealer, or Mercedes-Benz USA, LLC.

To contact NHTSA, you may call the Vehicle Safety Hotline toll-free at 1-888-327-4236 (TTY: 1-800-424-9153) ; go to <https://www.safercar.gov>; or write to: Administrator, NHTSA, 400 Seventh Street, SW., Washington, DC 20590, USA.

You can also obtain other information about motor vehicle safety from <https://www.safercar.gov>.

Canada only:

The following text is published as required of manufacturers under subsection 18.4 (4) of the Motor Vehicle Safety Regulations.

If you believe that your vehicle has a defect which could cause a crash or could cause injury or death, you should immediately inform Transport Canada in addition to notifying Mercedes-Benz Canada Inc.

If Transport Canada received similar complaints, it may open an investigation, and if it finds that a safety defect exists in a group of vehicles, it may order a recall and remedy campaign. However, Transport Canada cannot become involved in individual problems between you, your dealer, or Mercedes-Benz Canada Inc.

To contact Transport Canada, you may call the Defect Investigations and Recalls Division toll-free in Canada at 1-800-333-0510 or 819-994-3328 in the Gatineau-Ottawa area or internationally; may also go to the following websites for more information:

- English: <https://www.tc.gc.ca/recalls>
- French: <https://www.tc.gc.ca/rappels>

Limited Warranty

! **NOTE** Damage to the vehicle arising from violation of these operating instructions.

Damage to the vehicle can arise from violation of these operating instructions.

This damage is not covered either by the Mercedes-Benz implied warranty or by the New- or Used-Vehicle Warranty.

- ▶ Follow the instructions in these operating instructions on proper operation of your vehicle as well as on possible vehicle damage.

QR code for rescue card

QR codes are attached to the inside of the fuel filler flap and on the opposite side on the B-pillar. In the event of an accident, rescue services can use the QR code to quickly find the appropriate rescue card for your vehicle. The current rescue card contains the most important information about your vehicle (e.g. the routing of the electric lines) in compact form.

You can find further information at: <https://rk.mb-qr.com/de/>

Data storage

Data processing in the vehicle

Electronic control units

There are electronic control units installed in your vehicle. Control units process data that they e.g. receive from vehicle sensors, generate themselves or exchange among themselves. Some control units are required for the safe operation of your vehicle. For example, some assist you when you are driving, such as driver assistance systems, while others enable convenience or infotainment functions.

The following provides you with general information regarding data processing in the vehicle. Additional information on what specific data is collected, stored and transmitted to third parties for what purpose in your vehicle can be found in the notes on the functional features in question in the respective operating instructions. These are

also available online and, depending on the equipment, digitally in the vehicle.

Personal data

Each vehicle is marked with a unique vehicle identification number. Depending on the country, this vehicle identification number can be used by, for example, government authorities to determine the identity of the owner. There are other possibilities for using data collected from the vehicle to identify the owner or driver, such as the license plate number.

The data generated or processed by control units may therefore be personal or, in certain circumstances, become personal. Depending on which vehicle data are available, it may be possible to make inferences about, for example, your driving behavior, your location, your route or your use patterns.

Legal requirements for the disclosure of data

If legal regulations exist, manufacturers are generally obligated to release data stored by the manufacturer to the necessary extent in individual cases at the request of state authorities. This may

be the case during the investigation of a criminal offense, for example.

Within the framework of applicable law, state authorities are also authorized to take data readouts from vehicles themselves in specific cases. In the event of an accident, for example, information readouts can be taken from the air bag control unit to help to establish what happened.

Operating data in the vehicle

Control units process data to operate the vehicle.

This includes the following data, for example:

- Vehicle status information such as speed, longitudinal acceleration, lateral acceleration, number of wheel revolutions or the fastened seat belts indicator
- Ambient conditions, such as temperature, rain sensor or distance sensor

As a rule, this data is volatile, is not stored beyond the operating time and is processed only in the vehicle itself. Control units (e.g. the vehicle key) often contain data memories. These are used to temporarily or permanently document information about the vehicle's operating state, component

stress, maintenance requirements or technical events and malfunctions.

Depending on the technical equipment, the following data will be stored:

- Operating status of system components (e.g. fill levels, tire pressure, battery status)
- Malfunctions or faults in important system components (e.g. lights, brakes)
- System reactions in special driving situations (e.g. air bag deployment, the intervention of stability control systems)
- Information on events leading to vehicle damage

In special cases, it may be necessary to store data that would otherwise only be volatile. This may be the case if the vehicle has detected a malfunction, for example.

If you use services such as repair services or maintenance work, stored operational data readouts can be taken and used together with the vehicle identification number, where necessary. Readouts can be taken by service network employees such as workshops and manufactur-

ers, or third parties, such as breakdown services. The same is true in the case of warranty claims and quality assurance measures.

The readout will usually be taken via the diagnostics connection in the vehicle, which is required by law. The operating data readout taken documents technical conditions of the vehicle or individual components and helps to diagnose malfunctions, meet warranty obligations and improve quality. This data, particularly information on component stress, technical events, operating errors and other malfunctions, will be transmitted to the manufacturer for this purpose together with the vehicle identification number if necessary. In addition, the manufacturer is subject to product liability. For this reason, the manufacturer also uses operational data from the vehicle for e.g. recalls. This data can also be used to check customer claims for warranty and guarantee.

Fault memories in the vehicle can be reset by a service outlet or at your request as part of repair or maintenance work.

Comfort and infotainment functions

You can save comfort settings and individualization in the vehicle and change or reset them at any time.

Depending on the vehicle equipment, this includes the following settings, for example:

- Seat positions and steering wheel positions
- Suspension tuning and climate control settings
- Custom settings (e.g. interior lighting)

You can incorporate data into the vehicle's infotainment functions yourself as part of the selected equipment.

Depending on the vehicle equipment, this includes the following data, for example:

- Multimedia data (e.g. music, films or photos for playback in an integrated multimedia system)
- Address book data for use in conjunction with an integrated hands-free system or an integrated navigation system

- Navigation destinations that have been entered
- Data about the use of internet services

This data for comfort and infotainment functions can be saved locally in the vehicle or stored on a device that you have connected to the vehicle (e.g. smartphone, USB flash drive or MP3 player). If you have entered data yourself, you can delete it at any time.

The transfer of this data out of the vehicle will take place exclusively at your request. This applies in particular when you are using online services according to the settings you have selected.

Smartphone integration (e.g. Android Auto or Apple CarPlay®)

If your vehicle is equipped appropriately, you can connect your smartphone or another mobile device to the vehicle. You will then be able to control them using the controls integrated in the vehicle. The smartphone's picture and sound can be output via the multimedia system. Specific items of information will also be transferred to your smartphone. Depending on the type of integra-

tion, this may include position data, day/night mode and other general vehicle statuses. Please refer to the vehicle Operator's Manual / infotainment system operating instructions for further information.

This integration allows the use of selected smartphone apps (e.g. navigation apps, music player apps). There will be no further interaction between your smartphone and the vehicle; in particular, vehicle data will not be directly accessible. The type of additional data processing is determined by the provider of the app being used. Whether you can configure settings for it and, if so, which ones, depend on the app and your smartphone's operating system.

Online services

Wireless network connection

If your vehicle has a wireless network connection, it enables data to be exchanged between your vehicle and additional systems. The wireless network connection is made possible by the vehicle's own transmitter and receiver or by a mobile end device that you have brought into the vehicle, for

example, a smartphone. Online functions can be used via the wireless network connection. This includes online services and applications/apps provided to you by the manufacturer or by other providers.

Manufacturer's services

Regarding the manufacturer's online services, the individual functions are described by the manufacturer in a suitable place, for example, in the Operator's Manual or on the manufacturer's website, where the relevant data protection information is also given. Personal data may be used for the provision of online services. Data is exchanged via a secure connection, such as the manufacturer's designated IT systems. Any personal data which is collected, processed and used, other than for the provision of services, is done so exclusively on the basis of legal permission. This is the case, for example, for a legally prescribed emergency call system, a contractual agreement or when consent has been given.

You can have services and functions, some of which are subject to a fee, activated or deactivated. This excludes legally prescribed functions and services, such as an emergency call system.

Third-party services

If you use online services from other providers (third parties), these services are the responsibility of the provider in question and subject to that provider's data protection conditions and terms of use. As a general rule, the manufacturer has no influence on the content exchanged.

For this reason, when services are provided by third parties, please ask the service provider in question for information about the type, extent and purpose of the collection and use of personal data.

Data protection rights

Depending on your country or the equipment and range of functions of your vehicle as well as the services you use and the services on offer, you are entitled to different data protection rights. Further information on data protection and your data protection rights can either be found on the manufacturer's website or you will receive this information as part of the various services and service offers. There you will also find the contact

information for the manufacturer and its data protection officers.

At a workshop, for example, with the support of a specialist and possibly for a fee, you can have data read out which is stored only locally in the vehicle.

MBUX multimedia system/Mercedes me connect

If the vehicle is equipped with the MBUX multimedia system or Mercedes me connect, additional data about the vehicle's operation, the use of the vehicle in certain situations, and the location of the vehicle may be compiled by the MBUX multimedia system or Mercedes me connect.

For additional information, please refer to the "MBUX multimedia system" section and/or the Mercedes me connect Terms and Conditions.

Event data recorder

USA only:

This vehicle is equipped with an event data recorder (EDR). The main purpose of an EDR is to

record, in certain crash or near crash-like situations, such as an air bag deployment or hitting a road obstacle, data that will assist in understanding how a vehicle's systems performed. The EDR is designed to record data related to vehicle dynamics and safety systems for a short period of time, typically 30 seconds or less.

The EDR in this vehicle is designed to record such data as:

- How various systems in your vehicle were operating;
- Whether or not the driver and passenger safety belts were buckled/fastened;
- How far (if at all) the driver was depressing the accelerator and/or brake pedal; and,
- How fast the vehicle was traveling.

These data can help provide a better understanding of the circumstances in which crashes and injuries occur. NOTE: EDR data are recorded by your vehicle only if a non-trivial crash situation occurs; no data are recorded by the EDR under normal driving conditions and no personal data (e.g., name, gender, age, and crash location) are

recorded. However, other parties, such as law enforcement could combine the EDR data with the type of personally identifying data routinely acquired during a crash investigation.

To read data recorded by an EDR, special equipment is required, and access to the vehicle or the EDR is needed. In addition to the vehicle manufacturer, other parties, such as law enforcement, that have the special equipment, can read the information if they have access to the vehicle or the EDR.

EDR data may be used in civil and criminal matters as a tool in accident reconstruction, accident claims, and vehicle safety. Since the Crash Data Retrieval CDR tool that is used to extract data from the EDR is commercially available, Mercedes-Benz USA, LLC („MBUSA“) expressly disclaims any and all liability arising from the extraction of this information by unauthorized Mercedes-Benz personnel.

MBUSA will not share EDR data with others without the consent of the vehicle owners or, if the vehicle is leased, without the consent of the lessee. Exceptions to this representation include responses to subpoenas by law enforcement; by

federal, state or local government; in connection with or arising out of litigation involving MBUSA or its subsidiaries and affiliates; or, as required by law.

Warning: The EDR is a component of the Restraint System Module. Tampering with, altering, modifying or removing the EDR component may result in a malfunction of the Restraint System Module and other systems.

State laws or regulations regarding EDRs that conflict with federal regulation are pre-empted. This means that in the event of such conflict, the federal regulation governs. As of Dec 2016, 17 states have enacted laws relating to EDRs.

Copyright

Free and open source software

Information on licenses for free and open-source software used in your vehicle can be found on the data carrier in your vehicle document wallet and with updates on the following website:

<https://www.mercedes-benz.com/opensource>



Registered trademarks

- Bluetooth® is a registered trademark of Bluetooth SIG, Inc.
- DTS™ is a registered trademark of DTS, Inc.
- Dolby® and MLP™ are registered trademarks of DOLBY Laboratories.
- ESP® and PRE-SAFE® are registered trademarks of Mercedes-Benz Group AG.
- HomeLink® is a registered trademark of Genex Corporation.
- iPod® and iTunes® are registered trademarks of Apple Inc.
- Burmester® is a registered trademark of Burmester Audiosysteme GmbH.
- Microsoft® and Windows Media® are registered trademarks of Microsoft Corporation.
- SiriusXM® is a registered trademark of Sirius XM Radio Inc.
- HD Radio™ is a registered trademark of iBiquity Digital Corporation.
- Gracenote® is a registered trademark of Gracenote, Inc.
- ZAGAT Survey® and related brands are registered trademarks of Zagat Survey, LLC.

Brief overview of the most important points

Basic information

In particular ensure the following conditions to enable the components of the restraint system to unfold their protective potential:

- Sit correctly (→ page 41).
- Fasten the seat belt correctly (→ page 42).
 - Function of the  seat belt warning lamp (→ page 44).
 - Function of the rear seat belt status display (→ page 45).
- The  restraint system warning lamp has gone out after the self-test (→ page 43).
- The PASSENGER AIR BAG indicator lamps display the correct status of the front passenger air bag (→ page 45).

For clear understanding

The chapter "Occupant safety" includes information on equipment, functions and behaviors that contribute directly to safety of vehicle occupants.

The information is structured as follows:

- **The most important information in brief:** in this chapter, you are provided with an overview of the relationship between the restraint system and the correct behavior of all vehicle occupants.
- **Specific information:** in further sections of the chapter "Occupant safety", you can find specific information on the equipment and functions of the restraint system.
- **Keyword directory:** you can also find certain subjects in this Operator's Manual using the keyword directory.

Information on the following subjects, among others, are not provided in the chapter "Occupant safety":

- Children in the vehicle (→ page 58)
- Driving and driving safety systems (→ page 229)
- Stowage areas (→ page 119)

Defining generic terms clearly

In this Operator's Manual, the following generic terms are used:

- **Occupant safety:** comprises the components and system functions which help to minimize, as much as possible, the stresses on and consequences for vehicle occupants during an accident.
- **Restraint system:** comprises those components which, along with the vehicle structure, help prevent vehicle occupants from potentially coming into contact with parts of the vehicle interior. The seat belts and air bags, for example, are components of the restraint system.
- **Child restraint system:** you can find all information on this subject in the chapter "Children in the vehicle" (→ page 58).

Be diligent

For the components of the restraint system to provide the intended level of protection, it is essential that your posture is correct and that the seat belt is correctly fastened.

Please bear in mind that carelessness regarding the seating position and putting on the seat belt may have serious consequences. Be diligent and make sure that all vehicle occupants are sitting correctly and have fastened their seat belts properly before starting every journey.

Information on the correct seat position

The seat position must be correct in order for the components of the restraint system to provide the intended level of protection.

The seat position influences both the protection provided by the seat belt and the additional protection provided by the air bag.

The correct seat position with an almost upright posture and a correctly fastened seat belt also reduce the risk posed by the air bag when it is deployed.

When choosing the seat, take note of the available space. When you are sitting with the right posture in a nearly upright position, your head should not touch the roof.

⚠ WARNING Risk of injury or death due to an incorrect seat position

If you deviate from the correct seat position, the air bag cannot provide its intended protective function.

Each vehicle occupant must make sure of the following.

- ▶ Put the seat in the correct position.
- ▶ Fasten seat belts correctly. Pregnant women must take particular care to ensure that the lap belt never lies across the abdomen.
- ▶ Observe the following information.

In order for the restraint system to provide the intended level of protection, observe the following information:

- Before starting your journey, adjust your seat correctly (→ page 102).

When doing so, make sure you are able to fasten your seat belt correctly. The shoulder belt strap must be routed forward from the seat belt outlet over the center of your shoulder.

- Keep your distance from the air bags, especially the front air bags. Set the driver's seat and front passenger seat as far back as possible while making sure the seat belt is fastened correctly.
- If persons are sitting on the rear seats, vehicle occupants should maintain a sufficient distance to the parts of the vehicle interior in front of them.
- Make sure there are no people, animals or objects between the vehicle occupants and an air bag.
- If you are the driver, observe the following information on the correct position of the driver's seat (→ page 102).

Hold the steering wheel only by the steering wheel rim. This allows the driver's air bag to fully deploy.

- Assume a nearly upright position, with your buttocks as far back as possible in the gap between the seat cushion and seat backrest.

This ensures that your back lies as flat and firmly as possible against the seat backrest.

42 Occupant safety – Brief overview of the most important points

- While driving, do not lean forward and do not lean against the door or side window. You may otherwise be in the deployment area of the air bags.
- Sit with your feet resting on the floor, if possible. Your thighs are slightly supported by the seat cushion

Do not put your feet up on the cockpit, for example. Your feet may otherwise be in the deployment area of the air bag.

- Fasten the seat belt correctly.

Notes on wearing the seat belt correctly

Always fasten your seat belt correctly before starting a journey. A seat belt can provide the best level of protection only if it is worn correctly.

⚠ WARNING Risk of injury or death due to incorrectly fastened seat belt

If the seat belt is not worn correctly, it cannot perform its intended protective function.

In addition, an incorrectly fastened seat belt can also cause injuries, for example, in the event of an accident or when braking or changing direction suddenly.

- ▶ Always ensure that all vehicle occupants have their seat belts fastened correctly and are sitting properly.

⚠ WARNING Risk of injury or death when additional restraint systems are not used for persons with a smaller stature

Persons under 5 ft (1.50 m) tall cannot wear the seat belt correctly without a suitable additional restraint system.

- ▶ Always secure persons under 5 ft (1.50 m) tall in a suitable restraint system.

Each vehicle occupant must observe the following notes in particular:

- The seat belt must not be twisted:

- The shoulder belt strap must be routed forward from the seat belt outlet over the center of your shoulder.
- The shoulder belt strap should neither touch your neck nor be routed under your arm or behind your back.
- The lap belt must be routed as low down across the hips as possible.

In addition, push the lap belt down as far as possible across your hips and pull tight with the shoulder belt strap. Never route the lap belt across your abdomen.

Pregnant women must also take particular care with this.

- The shoulder belt strap and lap belt must fit snugly against the body after being tightened.
- Avoid wearing bulky clothing, e.g. a winter coat.
- Never route the seat belt across sharp, pointed, abrasive or fragile objects.
- Only one person should use each seat belt at any one time.

- Never secure objects with a seat belt if the seat belt is also being used by one of the vehicle's occupants.

Also ensure that no objects, e.g. a cushion, are ever placed between a person and the seat.

Fastening and adjusting seat belts

If the seat belt is pulled quickly or sharply, the seat belt retractor locks. The seat belt strap cannot be pulled out any further.

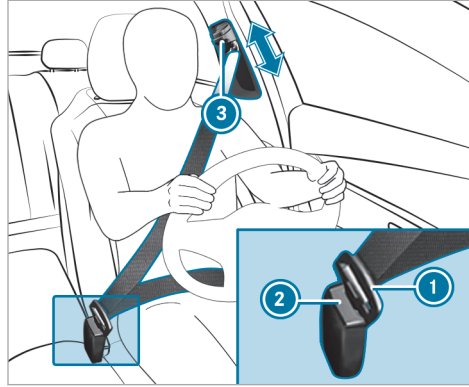

- ▶ Always engage seat belt tongue ① of the seat belt into seat belt buckle ② of the corresponding seat.
- ▶ **To adjust the seat belt height:** press button ③ on the seat belt outlet and slide the seat belt outlet to the desired position.
- ▶ **To engage the seat belt outlet:** release button ③ and ensure that the seat belt outlet engages.

! **NOTE** Deployment of components of the restraint system when the front passenger seat is unoccupied and a seat belt is buckled

When the front passenger seat is unoccupied and the seat belt tongue of the seat belt is engaged in the seat belt buckle, components of the restraint system may deploy unnecessarily on the front passenger side, e.g. the Emergency Tensioning Device.

▶ Only buckle the seat belts as intended.



i Observe the information on the child seat safety feature of the seat belt (→ page 66).

Function of the restraint system warning lamp

When the vehicle is switched on, a self-test is performed, during which the restraint system warning lamp  lights up. It goes out no later than a few seconds after the vehicle is started. The components of the restraint system are then functional.

44 Occupant safety – Brief overview of the most important points

A malfunction has occurred in the restraint system if:

- the restraint system warning lamp  does not light up or lights up continuously when the vehicle is switched on.
- the restraint system warning lamp  lights up continuously or repeatedly during a journey.

If components of the restraint system have been deployed, the restraint system warning lamp  will light up continuously.

WARNING Risk of injury due to malfunctions in the restraint system

Components in the restraint system may be activated unintentionally or not deploy as planned in an accident.

- ▶ Have the restraint system checked and repaired immediately at a qualified specialist workshop.

Plug-in hybrid: if the restraint system is malfunctioning, the automatic high-voltage emergency shutoff may not function.

DANGER Risk of fatal injuries due to malfunctions of the automatic high-voltage emergency shutoff

In the event of an accident, the high-voltage on-board electrical system may not be deactivated as intended.

You may be electrocuted if you touch the damaged component parts of the high-voltage on-board electrical system.

- ▶ Have the automatic high-voltage emergency shutoff checked and repaired immediately at a qualified specialist workshop.
- ▶ After an accident, switch off the vehicle immediately.

Mercedes-Benz recommends that you have the vehicle towed to a qualified specialist workshop.

Function of the seat belt warning lamp

The  seat belt warning lamp in the driver display is a reminder that all vehicle occupants must wear their seat belts correctly.

The  seat belt warning lamp lights up for six seconds every time the vehicle is started.

In addition, a warning tone may sound.

When the driver's and front passengers doors are closed and the driver and front passenger have fastened their seat belts, the seat belt warning goes out.

In the following cases, the seat belt warning lights up during a journey if:

- The driver or front passenger has not fastened their seat belt and the following criteria is met:
 - The vehicle speed exceeds 5 mph (9 km/h) for more than 20 seconds.
 - The vehicle speed exceeds 15 mph (25 km/h) once.
- The driver or front passenger unfastens their seat belt while the vehicle is in motion.

Function of the rear seat belt status display

The rear seat belt status display in the driver's display is a reminder that all vehicle occupants must wear their seat belts correctly.

In addition, a warning tone may sound.

If a person unfastens a seat belt in the rear passenger compartment while the vehicle is motion, the rear seat belt status display appears again.

Display in the driver's display

Every time the vehicle is switched on, the rear seat belt status display informs you for a certain amount of time which rear seat belt is not fastened.

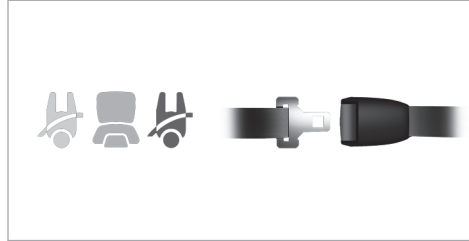

You can determine the status of the rear seat belt by the color of the seat symbol in the driver's display as follows:

- Gray: the rear seat belt is not fastened.
- Green: the seat belt tongue of a rear seat belt is engaged in the seat belt buckle of the displayed seat.
- Red: the person in the rear seat has unfastened their seatbelt.

Function of the PASSENGER AIR BAG indicator lamps (front passenger air bag)



The PASSENGER AIR BAG indicator lamps display the status of the front passenger air bag.

If the front passenger seat is occupied or a child restraint system is mounted on the front passenger seat, you must ensure, both before and during the journey, that the status of the front

passenger air bag is correct for the current situation.

⚠ WARNING Risk of potentially fatal injuries due to objects trapped under the front passenger seat

Objects trapped under the front passenger seat may interfere with the function of the automatic front passenger air bag shutoff or damage the system.

- ▶ Do not stow any objects under the front passenger seat.
- ▶ When the front passenger seat is occupied, ensure that no objects have become trapped beneath the front passenger seat.

Self-test: when the vehicle is switched on, both the PASSENGER AIR BAG ON and OFF indicator lamps will light up simultaneously for several seconds.

After the self-test, you can determine the status of the front passenger air bag as follows:

- **Front passenger air bag disabled:** PASSENGER AIR BAG OFF lights up continuously.

The front passenger air bag will not be deployed in the event of an accident. If PASSENGER AIR BAG OFF is lit, no one may use the front passenger seat.

If a rearward-facing child restraint system is installed on the front passenger seat, PASSENGER AIR BAG OFF must be lit continuously.

- **Front passenger air bag enabled:** PASSENGER AIR BAG ON lights up for up to 60 seconds or until both the PASSENGER AIR BAG ON and OFF indicator lamps go out.

The front passenger air bag may be deployed during an accident. If the front passenger air bag has this status, a rearward-facing child restraint system must not be installed on the front passenger seat.

- ⓘ If you are driving with a child in the vehicle, observe the information in the chapter entitled "Children in the vehicle" (→ page 58)

⚠ WARNING Risk of injury or death due to a disabled front passenger airbag

The front passenger airbag is disabled when the PASSENGER AIR BAG OFF indicator lamp is lit.

A person in the front passenger seat could then, for example, come into contact with the vehicle interior, especially if the person is sitting too close to the cockpit.

If the front passenger seat is occupied, always ensure that:

- The classification of the person in the front passenger seat is correct and the front passenger airbag is enabled or disabled in accordance with the person in the front passenger seat.
- The front passenger seat has been moved as far back as possible.

- The person is seated correctly.
- ▶ Both before and during the journey, ensure that the status of the front passenger airbag is correct.

Malfunction on automatic front passenger air bag shutoff

The PASSENGER AIR BAG OFF indicator lamp and the  restraint system warning lamp light up simultaneously.

In this case, no one may use the front passenger seat and no child restraint system may be installed on the front passenger seat.

Have the automatic front passenger air bag shutoff checked and repaired immediately at a qualified specialist workshop.

Be sure to also observe the following further related topics:

- Child restraint system on the front passenger seat (→ page 62)

Disabling or enabling the front passenger air bag

The automatic front passenger air bag shutoff can disable or enable the front passenger air bag according to the situation.

This happens automatically as a result of the classification of the person or child restraint system on the front passenger seat.

You cannot manually disable or enable the front passenger air bag.

Also observe the following information:

- For the status of the front passenger air bag, see "Function of the PASSENGER AIR BAG indicator lamps" (→ page 45)
- For information on using the automatic front passenger air bag shutoff, see "Information on the automatic front passenger air bag shutoff" (→ page 48)
- If you are driving with a child in the vehicle, observe the chapter "Children in the vehicle" (→ page 58)

Information on the child restraint system

When installing a child restraint system, observe the notes in "Children in the vehicle" (→ page 58).

Notes on the child restraint system on the front passenger seat

⚠ WARNING Risk of injury or fatal injuries if the front passenger air bag is enabled

If the front passenger air bag is enabled, a child on the front passenger seat may be struck by the front passenger air bag in the event of an accident.

▶ NEVER use a rearward-facing child restraint system on a seat with an ENABLED FRONT AIR BAG. This can result in the DEATH of or SERIOUS INJURY to the CHILD.

Also pay particular attention to the notes on rearward-facing or forward-facing child restraint systems on the front passenger seat (→ page 62).

Information on the automatic functions of the restraint system

Function of automatic front passenger air bag shut-off

A person on the front passenger seat must observe the following instructions:

- Sit correctly (→ page 41).
- Fasten seat belts correctly (→ page 42).

The automatic front passenger air bag shutoff can disable or enable the front passenger air bag according to the situation.

Make sure you observe the following information:

- The status of the front passenger air bag; see "Function of the PASSENGER AIR BAG indicator lamps"(→ page 45).
- When installing a child restraint system on the front passenger seat, observe the vehicle-specific information (→ page 62).

Status of the front passenger air bag in relation to the stature of the person:

- **Front passenger air bag disabled:** PASSENGER AIR BAG OFF lights up continuously.

The front passenger air bag will not be deployed in the event of an accident. If PASSENGER AIR BAG OFF is lit, no one may use the front passenger seat.

- **Front passenger air bag enabled:** PASSENGER AIR BAG ON lights up for up to 60 seconds or until both the PASSENGER AIR BAG ON and OFF indicator lamps go out.

The front passenger air bag may be deployed during an accident. Observe the following information on the correct seat position (→ page 41).

Vehicles with rear seats: a person of smaller stature should use a rear seat.

System limits

The front passenger air bag may otherwise be disabled by mistake, e.g. in the following situation:

- The front passenger transfers their weight by supporting themselves on a vehicle armrest.
- The front passenger sits in such a way that their weight is raised from the seat surface.

! **NOTE** Deployment of components of the restraint system when the front passenger seat is unoccupied

In an accident, the components of the restraint system may deploy unnecessarily on the front passenger side if:

- There are heavy objects on the front passenger seat.
- The seat belt tongue is engaged in the seat belt buckle of the front passenger seat and the front passenger seat is unoccupied.

- ▶ Store objects in a suitable place.
- ▶ Only one person should use each seat belt at any one time.

Depending on the detected accident situation, the window air bag on the front passenger side may deploy. The air bag will be deployed regardless of whether the front passenger seat is occupied.

Function of PRE-SAFE® (anticipatory occupant protection)

PRE-SAFE® is able to detect certain critical driving situations and implement pre-emptive measures to protect the vehicle occupants.

PRE-SAFE® can implement the following measures independently of each other:

- tightening the seat belts on the driver's seat and front passenger seat.
- closing the side windows.
- **Vehicles with sliding sunroof:** closing the sliding sunroof.
- **Vehicles with memory function:** moving the front passenger seat to a more favorable seat position.
- **PRE-SAFE® Sound:** provided that the multimedia system is switched on, generating a brief

noise signal to stimulate the innate protective mechanism of a person's hearing.

NOTE Damage caused by objects in the footwell or behind the seat

The automatic adjustment of the seat position may result in damage to the seat and/or the object.

- ▶ Stow objects in a suitable place.

Reverting the PRE-SAFE® system measures

If an accident did not occur, the pre-emptive measures that were taken will be reversed.

You will need to perform certain settings yourself.

- ▶ If the seat belt pre-tensioning is not reduced, move the seat backrest back slightly. The locking mechanism will release.

Function of PRE-SAFE® PLUS (anticipatory occupant protection plus)

PRE-SAFE® PLUS can detect certain impacts, particularly an imminent rear impact, and take pre-emptive measures to protect the vehicle occupants. These measures may not necessarily prevent an imminent impact.

PRE-SAFE® PLUS can implement the following measures independently of each other:

- Tightening the seat belts on the driver's seat and front passenger seat.
- Increasing brake pressure when the vehicle is stationary. This brake application is canceled automatically when the vehicle pulls away.

If an accident did not occur, the pre-emptive measures that were taken will be reversed.

System limits

The system will not initiate any action in the following situations:

- If the vehicle is backing up

The system will not initiate a brake application in the following situations:

- During a journey
or
- When the vehicle is entering or exiting a parking space using Active Parking Assist

Function of PRE-SAFE® Impulse Side

If an imminent side impact is detected, PRE-SAFE® Impulse Side can pre-emptively move the upper body of the vehicle occupant in the front seat towards the center of the vehicle. It does this by rapidly inflating an air cushion in the outer seat side bolster of the seat backrest on the side on which the impact is anticipated. This increases the distance between the door and the vehicle occupant.

If PRE-SAFE® Impulse Side has been deployed or is faulty, the following display message appears: **PRE-SAFE Pulse Side Inoperative See Operator's Manual** (→ page 500).

Seat belt adjustment function

Vehicles with PRE-SAFE®: after you have fastened the seat belt of the front seat, it may adjust itself against your body by pulling at the shoulder until somewhat tight. Do not hold the seat belt tightly while it is adjusting.

This function is a reminder that all vehicle occupants must wear their seat belts correctly.

You can activate and deactivate the seat belt adjustment function using the multimedia system (→ page 50).

Activating/deactivating seat belt adjustment via the multimedia system

Multimedia system:

→  » Settings » Vehicle
» Occupant Protection

▶ Activate or deactivate **Belt adjustment**.

Overview of the automatic measures after an accident

Depending on the type and severity of the accident, and depending on the vehicle's equipment, the following measures can be implemented, for example:

- automatic braking (post-collision brake)
- activating the hazard warning lights
- triggering an automatic emergency call (→ page 354)
- switching off the engine

To start the vehicle again, switch the vehicle off and on once more (→ page 176). Depending on the type and severity of the accident, you may no longer be able to start the vehicle.

- Switching off the fuel supply
- **Plug-in hybrid:** switching off the hybrid system and high-voltage on-board electrical system
- unlocking the vehicle doors
- lowering the side windows

- displaying the emergency guide on the central display
- switching on the interior lighting

Function of the post-collision brake after an accident

Depending on the accident situation, the post-collision brake can minimise the severity of a further collision or even avoid it.

If an accident is detected, the post-collision brake can initiate automatic braking. When the vehicle has come to a standstill, the electric parking brake is automatically applied.

The driver can cancel automatic braking by taking the following actions:

- Braking more strongly than automatic braking
- Fully depressing the accelerator pedal with force

Purpose and function of the restraint system

Overview of deployment situations (restraint system)

Make sure that the following prerequisites in particular have been met so that the components of the restraint system are able to provide the intended level of protection:

- Sit correctly (→ page 41).
- Fasten the seat belt correctly (→ page 42).
 - Function of the seat belt warning lamp (→ page 44).
 - Function of the rear seat belt status display (→ page 45).
- The restraint system warning lamp  is not lit up after the self-test (→ page 43).
- The PASSENGER AIR BAG indicator lamps display the correct status of the front passenger air bag (→ page 45).

Depending on the detected deployment situation, the components of the restraint system can be activated or deployed independently of each other:

- Emergency Tensioning Device: frontal impact, rear impact, side impact, rollover
- Driver's air bag, front passenger air bag: frontal impact
- Knee air bag: frontal impact
- Side impact air bag: side impact
- Center air bag in the driver's seat backrest: side impact
- Window curtain air bag: side impact, rollover, frontal impact
- PRE-SAFE® Impulse Side: side impact

The installation location of an air bag is identified by the AIRBAG symbol (→ page 57).

Observe the information on the function of the restraint system (→ page 52).

Information on how the restraint system works

The function of the restraint system depends on the severity of the impact detected and the apparent type of accident.

For more information about types of accidents, see "Overview of deployment situations" (→ page 51).

The activation thresholds for the components of the restraint system are determined based on the evaluation of the sensor values measured at various points in the vehicle. This process is pre-emptive in nature. The triggering of the components of the restraint system must take place in good time at the start of the impact.

Factors that can be seen and measured only after a collision has occurred do not play a decisive role in the deployment of an air bag, nor do they provide an indication of air bag deployment.

The vehicle may be deformed significantly without an air bag being deployed. This is the case if only parts that are relatively easily deformed are affected and the rate of vehicle deceleration is not high. Conversely, an air bag may be deployed even though the vehicle suffers only minor defor-

mation. If very rigid vehicle parts, such as longitudinal members, are hit, the vehicle deceleration may be high enough for this to happen.

Depending on the apparent type of accident and the detected deployment situation, Emergency Tensioning Devices and/or air bags supplement the protection offered by a correctly worn seat belt.

When enabled, an air bag can provide additional protection for the respective vehicle occupant.

Potential protection provided by each air bag:

- Knee air bag: thighs, knees and lower legs
- Driver's air bag, front passenger air bag: head and ribcage
- Window air bag: head
- Side air bag: ribcage, also pelvis for front seat occupants
- Center air bag: head and ribcage

However, no system available today can completely eliminate injuries and fatalities in every accident situation. In particular, the seat belt and air bag generally do not protect against objects

penetrating the vehicle from the outside. It is also not possible to completely rule out the risk of injury caused by the air bag deploying.

Mercedes-Benz recommends that you have the vehicle towed to a qualified specialist workshop after an accident. Take this into account, particularly if a Emergency Tensioning Device has been triggered or an air bag deployed.

If the Emergency Tensioning Devices are triggered or an air bag is deployed, you will hear a bang, and a small amount of fine powder may also be released:

- The bang will not generally affect your hearing.
- In general, the fine powder released is not hazardous to health but may cause short-term breathing difficulties to persons suffering from asthma or other respiratory problems.

Provided it is safe to do so, leave the vehicle immediately or open the window in order to prevent breathing difficulties.

Air bags and pyrotechnic Emergency Tensioning Devices contain perchlorate material, which may require special handling or environmental protec-

tion measures. National guidelines regarding waste disposal must be observed. In California, see <https://dtsc.ca.gov/>. You can use the search function to find information on perchlorate, for example.

Information on the limited protection provided by the restraint system

Risk due to the incorrect behavior of vehicle occupants

Every vehicle occupant must make sure of the following in particular:

- They observe the information on the correct seat position (→ page 41).
- There are no heavy, sharp-edged or fragile objects in the pockets of their clothing. Store such objects in a suitable place.

⚠ WARNING Risk of injury or death due to an incorrect seat position

The seat belt does not offer the intended level of protection if you have not moved the seat backrest to an almost vertical position.

In particular, you could slip beneath the seat-belt and become injured.

- ▶ Adjust the seat properly before beginning your journey.
- ▶ Always ensure that the seat backrest is in an almost vertical position and that the shoulder belt is routed across the center of your shoulder.

Risk due to objects in the vehicle interior

Every vehicle occupant must make sure of the following in particular:

- They observe the information on the correct seat position (→ page 41).
- There are no objects between the seat, door and door pillar (B-pillar).

- There are no hard objects, e.g. coat hangers, hanging on the grab handles or coat hooks.
- There are no heavy, sharp-edged or fragile objects in the pockets of their clothing. Store such objects in a suitable place.

⚠ WARNING Risk of injury or death due to blocked seat belt buckle or seat belt anchorage

Objects next to the front seat that block the seat belt buckle or the moving seat belt anchorage on the front seat impair the function of the Emergency Tensioning Devices.

- ▶ Before starting the journey, make sure that there are no objects around the seat belt buckle or between the front seat and door.

⚠ WARNING Risk of injury from objects in the deployment area of an airbag

Objects in the deployment area of an airbag can hinder or prevent the correct deployment of the airbag.

The airbag may then deploy in an uncontrolled manner and may even cause additional injuries to the vehicle occupants by deploying. This may be the case in particular if the airbag is integrated into the seat.

- ▶ Always stow and secure objects correctly.
- ▶ Before commencing your journey, make sure that no objects are stowed in the deployment area of an airbag.

The installation location of an air bag is identified by the AIRBAG (→ page 57) symbol.

Observe the following information:

- Notes on loading the vehicle (→ page 119)
- Information on the center air bag in the driver's seat backrest (→ page 57)

Risk due to installation of accessories

Do not attach accessories such as mobile navigation devices, mobile phones or cup holders within the deployment area of an air bag, e.g. on the cockpit, on the door, on the side window or on the side trim.

In addition, no connecting cables, tensioning straps or retaining straps may be routed or attached to the vehicle within the deployment area of an air bag. Always comply with the accessory manufacturer's installation instructions and, in particular, the notes on suitable places for installation.

⚠ WARNING Risk of injury or death due to unsuitable protective covers

Unsuitable protective covers mean that air bags can no longer protect vehicle occupants as they are designed to do.

- ▶ Use only protective covers approved by Mercedes-Benz for the seat in question.

In addition, the function of the automatic front passenger air bag shutoff could be restricted due to an unsuitable protective cover. If the front passenger seat is occupied, ensure that the PASSENGER AIR BAG indicator lamps display the correct status of the front passenger air bag (→ page 45).

Risk due to pets in the vehicle interior

⚠ WARNING Risk of accident and injury due to animals left unsecured or unattended in the vehicle

If you leave animals in the vehicle unattended or unsecured, they could possibly press buttons or switches.

An animal may:

- Activate vehicle equipment and become trapped, for example
- Switch systems on or off and endanger other road users

Unsecured animals may be thrown around in the vehicle in the event of an accident or sudden steering and braking maneuvers and injure vehicle occupants in the process.

- ▶ Never leave animals in the vehicle unattended.
- ▶ Always correctly secure animals while driving, e.g. using a suitable animal carrier.

Risk due to modification, damage or wear to the components of the restraint system**! NOTE** Mercedes-AMG vehicles

- ▶ Observe the notes in the Supplement. You could otherwise fail to recognize dangers.

⚠ WARNING Risk of injury or death due to modifications to the restraint system

Vehicle occupants may no longer be protected as intended if alterations are made to the restraint system.

- ▶ Never alter the parts of the restraint system.
- ▶ Never tamper with the wiring or any electronic component parts or their software.

If it is necessary to modify the vehicle to accommodate a person with disabilities, contact an authorized Mercedes-Benz Center for details.

USA only: for details, contact our Customer Assistance Center on 1-800-FOR-MERCEDES (1-800-367-6372).

⚠ WARNING Risk of injury or death due to damaged or modified seat belts

Seat belts cannot provide protection in the following situations:

- The seat belt is damaged, has been modified, is extremely dirty, bleached or dyed
- The seat belt buckle is damaged or extremely dirty
- Modifications have been made to the Emergency Tensioning Device, seat belt anchorage or seat belt retractor

Seat belts may sustain non-visible damage in an accident, e.g. due to glass splinters.

Modified or damaged seat belts could tear or fail in the event of an accident, for example.

Modified Emergency Tensioning Devices could accidentally trigger or fail to function as intended.

- ▶ Never modify the seat belt system, for example the seat belt, seat belt buckle, Emergency Tensioning Device, seat belt anchorage and seat belt retractor.
- ▶ Make sure that the seat belts are undamaged, not worn and clean.
- ▶ Always have the seat belts checked immediately after an accident at a qualified specialist workshop.

Use only seat belts that have been approved for your vehicle by Mercedes-Benz.

⚠ WARNING Risk of injury due to modifications to the cover of an airbag

If you change the cover of an airbag or attach objects, e.g. even stickers, to it, the airbag may no longer function as intended.

- ▶ Never modify the cover of an airbag.
- ▶ Do not attach any objects to the cover.

The installation location of an air bag is identified by the AIRBAG symbol (→ page 57).

⚠ WARNING Risk of injury due to malfunctioning sensors in the door

The function of the airbags can be impaired due to modifications or incorrect work performed on the doors or door trim, or if the doors are damaged.

- ▶ Never modify the doors or parts of the doors.
- ▶ Always have work on the doors or door trim carried out at a qualified specialist workshop.

Risk due to components of the restraint system that have already been deployed

Mercedes-Benz recommends that you have the vehicle towed to a qualified specialist workshop after an accident.

⚠ WARNING Risk of burns from hot air bag components

The air bag parts are hot after an air bag has been deployed.

- ▶ Do not touch the air bag parts.
- ▶ Have a deployed air bag replaced at a qualified specialist workshop as soon as possible.

⚠ WARNING Risk of injury due to deployed airbag

A deployed airbag no longer offers any protection.

- ▶ Have the vehicle towed to a qualified specialist workshop in order to have the deployed airbag replaced.

Have deployed air bags replaced immediately.

⚠ WARNING Risk of injury or death from deployed pyrotechnic Emergency Tensioning Devices

Pyrotechnic Emergency Tensioning Devices that have been deployed are no longer operational and are unable to perform their intended protective function.

- ▶ Therefore, have deployed pyrotechnic Emergency Tensioning Devices immediately replaced at a qualified specialist workshop.

Seat belts

Releasing the seat belts

- ▶ Press the release button in the seat belt buckle and guide the seat belt back with the seat belt tongue.

! **NOTE** Damage caused by trapping the seat belt

If an unused seat belt is not fully retracted, it may become trapped in the door or in the seat mechanism.

- ▶ Always ensure that an unused seat belt is fully retracted.

Airbags

Overview of air bags

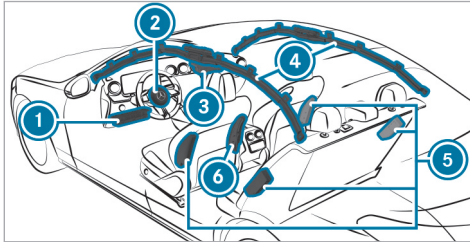

- ❶ Knee air bag
- ❷ Driver's air bag
- ❸ Front passenger air bag
- ❹ Window air bag
- ❺ Side air bag
- ❻ Center air bag

The installation location of an air bag is identified by the AIRBAG symbol. An additional arrow symbol ► indicates the installation location for certain air bags.

Observe the information in "Overview of deployment situations" (→ page 51).

Information on the center air bag in the driver's seat backrest

When triggered, the center air bag deploys between the front seats. Do not stow any objects in the deployment area of the center air bag.

Observe the notes on loading the vehicle (→ page 119).

Key facts in brief

Safely transporting children in the vehicle

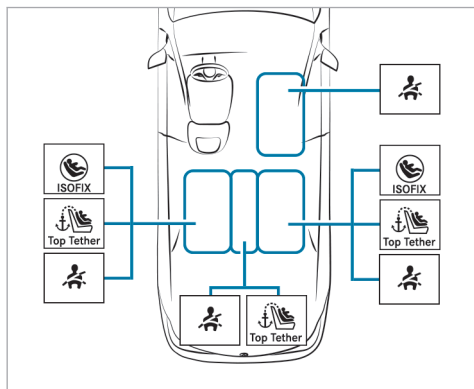



Always observe the following when transporting children:

- Never leave children unattended in the vehicle (→ page 60).



- Secure children younger than twelve or of a height lower than 5 ft (1.50 m) on the seat (see illustration above) properly with a suitable and approved child restraint system and secure small children in a rearward-facing child restraint system.
- Observe the child restraint system manufacturer's installation instructions.

Left/right rear seat (preferred seats)

Preferred fastening system:

-  LATCH-type (ISOFIX) securing rings (→ page 67)
-  and additionally fasten Top Tether if available (→ page 68).

Alternative fastening system:

-  Vehicle seat belt (→ page 70)
-  Additionally fasten Top Tether if recommended by the manufacturer of the child restraint system (→ page 68).

Front passenger seat

Fastening system:



-  Vehicle seat belt (→ page 70)

Be sure to observe:

- If the front passenger seat is occupied, ensure that the status of the front passenger air bag is correct for the current situation (→ page 45).

Center rear seat

Fastening system:

-  Vehicle seat belt (→ page 70)
-  Additionally fasten Top Tether if recommended by the manufacturer of the child restraint system (→ page 68).

Important safety notes

Basic information

Be diligent

Bear in mind that negligence when securing a child in the child restraint system may have seri-

ous consequences. Always be diligent in securing a child carefully before every journey.

Never allow babies and children to travel sitting on the lap of another vehicle occupant.

To improve protection for children younger than twelve years old or under 5 ft (1.50 m) in height, Mercedes-Benz recommends you observe the following information:

- Always secure the child in a child restraint system suitable for this Mercedes-Benz vehicle.
- The child restraint system must be appropriate to the age, weight and size of the child.
- The vehicle seat must be suitable for the child restraint system to be installed:

Accident statistics show that children secured on the rear seats are generally safer than children secured on the front seats. For this reason, Mercedes-Benz strongly advises that you install a child restraint system to a rear seat.

The generic term child restraint system

The generic term child restraint system is used in this Operator's Manual. A child restraint system is, for example:

- a baby car seat
- a rearward-facing child seat
- a forward-facing child seat
- a child booster seat – Mercedes-Benz recommends using a child booster seat **with** a seat backrest and seat belt guide.

Observe laws and legal requirements

Always observe the legal requirements when using a child restraint system in the vehicle.

Securing systems for child restraint systems in the vehicle

Use only the following securing systems for child restraint systems:

- The ISOFIX mounting bracket
- The vehicle's seat belt system
- The Top Tether anchorages

Simply attaching to the ISOFIX mounting brackets on the vehicle can reduce the risk of installing the child restraint system incorrectly.

When securing a child with the integrated seat belt of the ISOFIX/LATCH child restraint system, always comply with the permissible gross weight for the child and child restraint system (→ page 67).

A child booster seat may be necessary to achieve proper seat belt positioning for children over 40 lbs (18 kg) in weight or until they reach a height where a three-point seat belt can be installed properly without a child booster seat.

Mercedes-Benz recommends a suitable child booster seat with a backrest and seat belt guide.

Observe standards for child restraint systems

All child restraint systems must meet the following standards:

- U.S. Federal Motor Vehicle Safety Standards 213
- Canadian Motor Vehicle Safety Standards 213

Confirmation that the child restraint system complies with the standards can be found on an information label on the child restraint system. This confirmation can also be found in the installation instructions that are included with the child restraint system.

Important warning stickers

Always secure a child restraint system correctly

⚠ WARNING Risk of injury or death due to incorrect installation of the child restraint system

The child can then not be protected or restrained as intended.

- ▶ Be sure to comply with the manufacturer's installation instructions for the child restraint system and its correct use.
- ▶ Make sure that the entire base of the child restraint system always rests on the sitting surface of the seat.

- ▶ Never place objects (e.g. cushions) under or behind the child restraint system.
- ▶ Use child restraint systems only with the original cover designed for them.
- ▶ Always replace damaged covers with genuine covers.

- Always observe the vehicle-specific information.
 - Installing the ISOFIX/LATCH child restraint system on the right and left rear seats (→ page 67).
 - Securing the child restraint system with the seat belt (→ page 70).
- Observe the warning labels in the vehicle interior and on the child restraint system.

⚠ WARNING Risk of injury or death due to unsecured child restraint systems in the vehicle

If the child restraint system is incorrectly mounted or unsecured, it may come loose.

The child can then not be protected or restrained as intended.

Unused child restraint systems could be flung around and hit vehicle occupants.

- ▶ Always comply with the manufacturer's installation instructions for the child restraint system and its correct use.
- ▶ Always fit child restraint systems correctly, even if they are transported in the vehicle unused.

Do not modify the child restraint system

⚠ WARNING Risk of injury due to modifications to the child restraint system

The child restraint system can no longer function properly. This poses an increased risk of injury.

- ▶ Never modify a child restraint system.
- ▶ Only affix accessories which have been specially approved for this child restraint system by the child restraint system's manufacturer.

Only use child restraint systems which are in proper working condition

⚠ WARNING Risk of injury or death caused by the use of damaged child restraint systems

Child restraint systems or their retaining systems that have been subjected to stress in an accident may not be able to perform their intended protective function.

It may be the case that the child cannot be properly restrained.

- ▶ Always immediately replace child restraint systems that have been damaged or involved in an accident.
- ▶ Have the securing systems for the child restraint systems checked at a qualified specialist workshop before installing a child restraint system again.

Avoid direct sunlight

⚠ WARNING Risk of burns when the child seat is exposed to direct sunlight

If the child restraint system is exposed to direct sunlight or heat, parts could heat up excessively.

Children could suffer burns from these parts, particularly the metallic parts of the child restraint system.

- ▶ Always make sure that the child restraint system is not exposed to direct sunlight.
- ▶ Cover the child restraint system with a blanket, for example.
- ▶ If the child restraint system has been exposed to direct sunlight, allow it to cool before securing a child into it.
- ▶ Never leave children unattended in the vehicle.

Observe when stopping or parking

⚠ WARNING Risk of fatal injury due to exposure to extreme heat or cold in the vehicle

If persons, particularly children, are subjected to prolonged exposure to intense heat or cold, there is a risk of severe injury or even death.

- ▶ Never leave persons, particularly children, unattended in the vehicle.

⚠ WARNING Risk of accident and injury if children are left unattended in the vehicle

If children are left unattended in the vehicle, they could in particular:

- open doors, thereby endangering other persons or road users.
- get out and be struck by oncoming traffic.
- operate vehicle equipment and become trapped, for example.

In addition, the children could also set the vehicle in motion, for example by:

- releasing the parking brake.
 - changing gear.
 - starting the vehicle.
- ▶ Never leave children unattended in the vehicle.
- ▶ When leaving the vehicle, always take the SmartKey with you and lock the vehicle.
- ▶ Keep the SmartKey out of the reach of children.

Notes on rearward-facing and front-facing child restraint systems on the front passenger seat

▲ WARNING Risk of injury or fatal injury when using a rearward-facing child restraint system while the co-driver airbag is enabled

If you secure a child in a rearward-facing child restraint system on the co-driver seat and the

PASSENGER AIR BAG OFF indicator lamp is off, the co-driver airbag can deploy in the event of an accident.

The child could be struck by the airbag.

- ▶ Always ensure that the co-driver airbag is disabled. The PASSENGER AIR BAG OFF indicator lamp must be lit.
- ▶ NEVER use a rearward-facing child restraint system on a seat with an ENABLED FRONT AIRBAG; DEATH or SERIOUS INJURY to the CHILD can occur.

Observe the specific instructions for the rearward-facing and forward-facing child restraint systems (→ page 64).

If it is absolutely necessary to install a child restraint system on the front passenger seat, always observe the following information:

- When a rearward-facing child restraint system is used on the front passenger seat, the front passenger air bag must always be disabled. This is the case only if the PASSENGER AIR

BAG OFF indicator lamp is lit continuously (→ page 45).

- The front passenger air bag is enabled when the PASSENGER AIR BAG OFF indicator lamp is not lit. The front passenger air bag may be deployed during an accident. In that case, do not use rearward-facing child restraint systems.

Information on the automatic front passenger air bag shutoff

If the front passenger seat is occupied, ensure, both before and during the journey, that the status of the front passenger air bag is correct for the current situation.

▲ WARNING Risk of injury or death due to objects between the seat surface and the child restraint system

Objects between the seat surface and the child restraint system can interfere with the function of the automatic front passenger air bag shutoff.

- ▶ Do not place any objects between the seat surface and the child restraint system.
- ▶ Make sure that the entire base of the child restraint system rests on the seat cushion of the front passenger seat.
- ▶ The backrest of a forward-facing child restraint system must, as far as possible, be resting against the seat backrest of the front passenger seat.
- ▶ Always comply with the installation instructions from the child restraint system manufacturer.

When installing a child restraint system to the front passenger seat, observe the vehicle-specific information (→ page 62).

Rearward-facing child restraint system on the front passenger seat

If a rearward-facing child restraint system is installed on the front passenger seat, the front passenger air bag must be deactivated. The PASSENGER AIR BAG OFF indicator lamp must light up continuously (→ page 45).

⚠ WARNING Risk of injury or fatal injury when using a rearward-facing child restraint system while the co-driver airbag is enabled

If you secure a child in a rearward-facing child restraint system on the co-driver seat and the PASSENGER AIR BAG OFF indicator lamp is off, the co-driver airbag can deploy in the event of an accident.

The child could be struck by the airbag.

- ▶ Always ensure that the co-driver airbag is disabled. The PASSENGER AIR BAG OFF indicator lamp must be lit.
- ▶ NEVER use a rearward-facing child restraint system on a seat with an ENABLED FRONT AIRBAG; DEATH or SERIOUS INJURY to the CHILD can occur.

- ⓘ The front passenger air bag is enabled depending on the child restraint system and the stature of the child. The PASSENGER AIR BAG OFF indicator lamp does not light up. The front passenger air bag may be deployed during an accident. If the front passenger air

bag is in this status, no rearward-facing child restraint system may be installed on the front passenger seat. Instead, install the rearward-facing child restraint system on a suitable rear seat.

Forward-facing child restraint system on the front passenger seat

If a forward-facing child restraint system is installed on the front passenger seat, the front passenger air bag may be automatically enabled or disabled. The status of the front passenger air bag depends on the child restraint system and the stature of the child.

The PASSENGER AIR BAG OFF indicator lamp is either lit continuously, or it is not lit (→ page 45). Always observe the following information.

⚠ WARNING Risk of injury or death due to incorrect positioning of the child restraint system

If you secure a child in a forward-facing child restraint system on the co-driver seat and you position the co-driver seat too close to the dashboard, in the event of an accident, the child could:

- come into contact with the vehicle's interior if the PASSENGER AIR BAG OFF indicator lamp is lit, for example
- be struck by the airbag if the PASSENGER AIR BAG OFF indicator lamp is off

▶ Always move the co-driver seat as far back as possible. In doing so, always make sure that the shoulder belt strap is correctly routed from the seat belt outlet of the vehicle to the shoulder belt guide on the child restraint system. The shoulder belt strap must be routed forwards and downwards from the seat belt outlet.

If necessary, adjust the seat belt outlet and the co-driver seat accordingly.

▶ Always comply with the child restraint system manufacturer's installation instructions.

Be sure to also observe the following further related topics:

- Function of the automatic front passenger air bag shut-off (→ page 45)

Suitable child restraint systems for the transport of children

Information on the advantage of a rearward-facing child restraint system

Transport a baby in a suitable rearward-facing child restraint system only. It is also preferable to transport a small child in a suitable rearward-facing child restraint system. In this case, the child sits in the opposite direction to the direction of travel and faces backwards.

Babies and small children have comparatively weak neck muscles in relation to the size and weight of their head. The risk of injury to the cervical spine during an accident can be reduced in a rearward-facing child restraint system.

Securing the child restraint system

Adjusting the seat correctly

When installing a child restraint system on the left or right rear seat, always observe the following:

▶ Make sure that the child's feet do not touch the front seat. If necessary, move the front seat slightly forwards.

If the head restraint of the child restraint system cannot be fully extended when it is installed in the vehicle, this will result in restrictions on the maximum size setting for certain child restraint systems. Observe the child restraint system manufacturer's installation instructions.

ⓘ Contact with the roof when the head restraint is fully extended and locked in place will not result in any restrictions on use.

 Also observe the following when installing an ISOFIX child restraint system:

- ▶ **When using a rearward-facing child restraint system on a rear seat:** adjust the front seat such that it does not touch the child restraint system.
- ▶ **When using a forward-facing child restraint system with integrated child seat belt:** adjust the head restraint of the respective seat such that it does not push the child restraint system forwards. If necessary, the corresponding head restraint can be removed. In addition, the seat backrest of the child restraint system must lie as flat as possible against the backrest of the vehicle seat. After the child restraint system has been removed, replace the vehicle head restraint immediately and adjust it correctly.
- ▶ The child restraint system must not be put under strain between the roof and the seat cushion and/or be installed facing in the wrong direction. Where possible, adjust the seat cushion angle accordingly.

- ▶ Adjust the vehicle head restraints such that the child restraint system is not put under strain by the head restraint.

 **When installing a belt-secured child restraint system, also observe the following:**

- ▶ **When using a rearward-facing child restraint system on a rear seat:** adjust the front seat such that it does not touch the child restraint system.
- ▶ Additionally fasten Top Tether if present (→ page 68).
- ▶ **When using a forward-facing child restraint system with integrated child seat belt:** adjust the head restraint of the respective seat such that it does not push the child restraint system forwards. If necessary, the corresponding head restraint can be removed. In addition, the seat backrest of the child restraint system must lie as flat as possible against the backrest of the vehicle seat. After the child restraint system has been removed, replace the vehicle head restraint immediately and adjust it correctly.

- ▶ The backrest of the forward-facing child restraint system must, as far as possible, be resting on the seat backrest of the rear seat.
- ▶ The child restraint system must not be put under strain between the roof and the seat cushion and/or be installed facing in the wrong direction. Where possible, adjust the seat cushion angle accordingly.
- ▶ Adjust the vehicle head restraints such that the child restraint system is not put under strain by the head restraint.
- ▶ Make sure that the child's feet do not touch the front seat. If necessary, move the front seat slightly forwards.

 **Depending on the vehicle equipment, always observe the following when installing a belt-secured child restraint system on the front passenger seat:**

- ▶ Observe the notes on rearward-facing and forward-facing child restraint systems on the front passenger seat (→ page 62).
- ▶ **When using a forward-facing child restraint system integrated child seat belt:** remove the

head restraint from the front passenger seat, if possible. After the child restraint system has been removed, immediately replace the head restraint and adjust it correctly.

- ▶ The backrest of the forward-facing child restraint system must, as far as possible, be resting on the seat backrest of the front passenger seat.
- ▶ The child restraint system must not be put under strain between the roof and the seat cushion and/or be installed facing in the wrong direction.
- ▶ Adjust the vehicle head restraints such that the child restraint system is not put under strain by the head restraint.
- ▶ Never place objects (e.g. cushions) under or behind the child restraint system.
- ▶ Set the front passenger seat as far back as possible and move the seat into the highest position if possible. Always make sure that the shoulder belt strap is correctly routed from the seat belt outlet of the vehicle to the shoulder belt guide on the child restraint system. The shoulder belt strap must be routed for-

wards from the seat belt outlet and, where possible, downwards to the child restraint system.

- ▶ Fully retract the seat cushion length adjustment.
- ▶ Adjust the seat cushion inclination such that the front edge of the seat cushion is in the highest position and the rear edge of the seat cushion is in the lowest position.
- ▶ Set the seat backrest to the most vertical position possible.

Activating/deactivating the child seat safety feature of the seat belt

⚠ WARNING Risk of injury or death if a seat belt is unfastened while the vehicle is in motion

If the seat belt is released while the vehicle is in motion, the special seat belt retractor is deactivated and the child restraint system is no longer correctly secured. The seat belt is

drawn in slightly by the inertia reel and cannot be immediately closed again.

- ▶ Stop the vehicle immediately in accordance with the traffic conditions.
- ▶ Activate the special seat belt retractor again and correctly secure the child restraint system.

When enabled, the child seat safety feature ensures that the seat belts of the front passenger seat and rear seats do not slacken once the child restraint system is secured.

The seat belts on the following seats are equipped with a child seat safety feature:

- Front passenger seat
- Rear seats

Installing a child restraint system

- ▶ When installing a child restraint system, always observe the manufacturer's installation and operating instructions as well as the information in this Operator's Manual.

- ▶ Pull the seat belt smoothly from the seat belt outlet.
- ▶ Engage the seat belt tongue in the seat belt buckle.

Activating the child seat safety feature:

- ▶ Pull the seat belt out fully and let the inertia reel retract it again. When the child seat safety feature is activated, you should hear a ratcheting sound.
- ▶ Push the child restraint system down until the seat belt sits tightly.

Deactivating the child seat safety feature:

- ▶ Press the release button of the seat belt buckle.
- ▶ Hold the seat belt tongue and guide it back to the seat belt outlet.

Installing an ISOFIX/LATCH child restraint system

- ⚠ WARNING** Risk of accident if the rear bench seat, rear seat and seat backrest are not engaged

The rear bench seat, rear seat and seat backrest may fold forwards, even when you are driving.

- As a result, the vehicle occupant will be pushed into the seat belt with increased force. The seat belt will not be able to protect as intended and could cause additional injury.
 - Objects or loads in the trunk or cargo compartment will not be restrained by the seat backrest.
- ▶ Make sure that the rear bench seat, the rear seat and the seat backrest are engaged before every trip.

If the rear seat backrest is not engaged and locked in place, the red lock verification indicator will be visible.

- ⚠ WARNING** Risk of injury or death if the permissible gross mass of the child and child restraint system together is exceeded.

Too much load may be placed on the LATCH-type (ISOFIX) or iSize child restraint systems and the child may not be restrained correctly in the event of an accident, for example.

- ▶ If the child is secured in a LATCH-type (ISOFIX) child restraint system with integrated seat belt, the total mass of the child and child restraint system must not exceed 73 lb (33 kg).

Always observe the information on the mass of the child:

- in the installation and operating instructions of the manufacturer of the child restraint system used
- on a label on the child restraint system, if present

Check regularly that the permissible gross mass of the child plus the child restraint system is not exceeded.

When installing a child restraint system, also observe the following:

- ☑ Always observe the area of use and the suitability of the seats for attaching a child restraint system.

LATCH-type (ISOFIX) securing rings

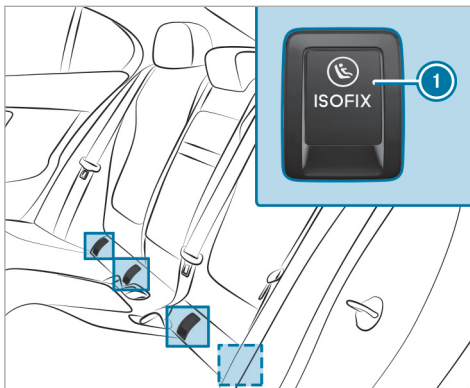

① LATCH-type (ISOFIX) securing ring

- ▶ Before every journey, make sure that the ISO-FIX/LATCH child restraint system has correctly engaged both securing rings in the vehicle.

❗ **NOTE** Damage to the seat belt for the center seat during installation of the child restraint system

- ▶ Make sure that the seat belt is not trapped.

- ▶ Fold the covers of LATCH-type (ISOFIX) securing rings ① back.
- ▶ Attach the ISOFIX/LATCH child restraint system to both securing rings ① in the vehicle.

Fastening a Top Tether

⚠ **WARNING** Risk of injury or death if the rear seat backrests are not locked after Top Tether belts are installed

The rear seat backrests may fold forwards when you are driving.

As a result, child restraint systems will no longer be able to perform their intended protective function. This may also cause additional injuries.

- ▶ Always lock rear seat backrests after installing Top Tether belts.
- ▶ Observe the lock verification indicator.

If the rear seat backrest is not engaged and locked in place, the red lock verification indicator will be visible.

-  If the child restraint system is equipped with a Top Tether belt:

The risk of injury may be reduced by Top Tether. The Top Tether belt enables an additional connection between the child restraint system attached with ISOFIX/LATCH (left and right rear seats) or the seat belt (all rear seats) and the vehicle.

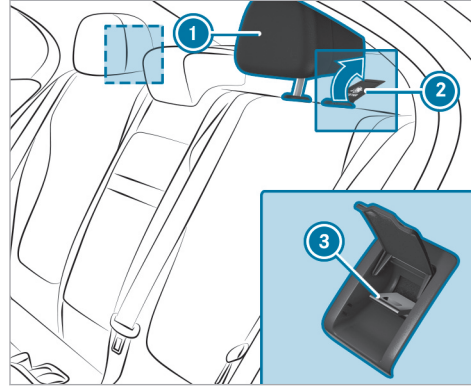

- ▶ If necessary, slide head restraint ① upwards (→ page 109).
- ▶ Fold up cover ② of Top Tether anchorage ③.
- ▶ Install the ISOFIX/LATCH or belt-secured child restraint system with Top Tether. In doing so, comply with the child restraint system manufacturer's installation instructions.

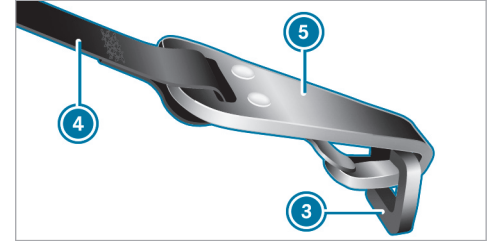

- ▶ Guide Top Tether belt ④ under head restraint ① between the two head restraint bars.
- ▶ Hook Top Tether hook ⑤ of Top Tether belt ④ into Top Tether anchorage ③ without twisting.
- ▶ Tension Top Tether belt ④. In doing so, comply with the child restraint system manufacturer's installation instructions.
- ▶ Fold down cover ② of Top Tether anchorage ③.
- ▶ If necessary, slide head restraint ① downwards (→ page 109). Make sure that you do not interfere with the correct routing of Top Tether belt ④.

Securing the child restraint system with the seat belt

⚠ WARNING Risk of accident if the rear bench seat, rear seat and seat backrest are not engaged

The rear bench seat, rear seat and seat backrest may fold forwards, even when you are driving.

- As a result, the vehicle occupant will be pushed into the seat belt with increased force. The seat belt will not be able to protect as intended and could cause additional injury.
- Objects or loads in the trunk or cargo compartment will not be restrained by the seat backrest.

▶ Make sure that the rear bench seat, the rear seat and the seat backrest are engaged before every trip.

If the rear seat backrest is not engaged and locked in place, the red lock verification indicator will be visible.

The seat belts on the following seats are equipped with a child seat safety feature:

- Front passenger seat
- Rear seats

When enabled, the child seat lock ensures that the seat belts of the front passenger seat and rear seats do not slacken once the child restraint system is secured.

- ▶ For a child restraint system in the "Universal" or "Semi-Universal" category, make sure that the system has been approved for the vehicle seat.
- ▶ Install the child restraint system. The entire base of the child restraint system must always rest on the surface of the seat.
- ▶ Always make sure that the shoulder belt strap is correctly routed from the vehicle belt outlet to the shoulder belt guide on the child restraint system. The shoulder belt strap must be routed forwards from the seat belt outlet and, where possible, downwards to the child restraint system.

▶ **When installing on the rear seat:** also secure Top Tether, if present.

▶ **When installing on the front passenger seat:** if necessary, adjust the seat belt outlet and the front passenger seat appropriately.

Child safety locks

Activating/deactivating the child safety lock for the rear doors

⚠ WARNING Risk of accident and injury if children are left unattended in the vehicle

If children are left unattended in the vehicle, they could in particular:

- open doors, thereby endangering other persons or road users.
- get out and be struck by oncoming traffic.
- operate vehicle equipment and become trapped, for example.

In addition, the children could also set the vehicle in motion, for example by:

- releasing the parking brake.
- changing gear.
- starting the vehicle.

- ▶ Never leave children unattended in the vehicle.
- ▶ When leaving the vehicle, always take the SmartKey with you and lock the vehicle.
- ▶ Keep the SmartKey out of the reach of children.

⚠ WARNING Risk of fatal injury due to exposure to extreme heat or cold in the vehicle

If persons, particularly children, are subjected to prolonged exposure to intense heat or cold, there is a risk of severe injury or even death.

- ▶ Never leave persons, particularly children, unattended in the vehicle.

⚠ WARNING Risk of accident and injury due to children left unattended in the vehicle

If children are traveling in the vehicle, they could, in particular:

- Open doors, thereby endangering other persons or road users.
 - Get out and be struck by oncoming traffic.
 - Operate vehicle equipment and become trapped, for example.
- ▶ Always activate the installed child safety locks if children are traveling in the vehicle.
 - ▶ Never leave children unattended in the vehicle.
 - ▶ When leaving the vehicle, always take the SmartKey with you and lock the vehicle.

There are child safety locks for the rear doors and the rear side windows. The child safety locks on the rear doors secure each door separately. The doors can no longer be opened from the inside.

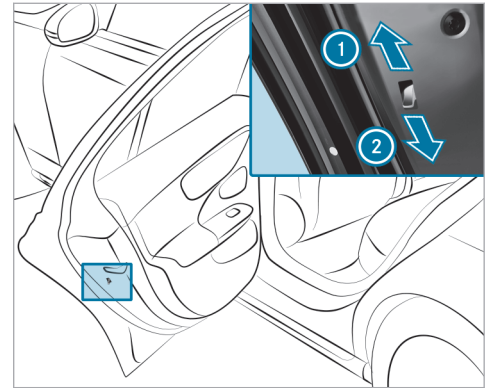

- ▶ Press the lever in direction ① (activate) or ② (deactivate).
- ▶ Check the functionality of the child safety lock.

Activating and deactivating the child safety lock for the rear side windows

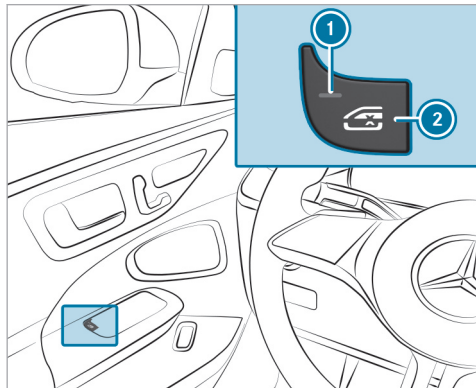

▶ **To activate/deactivate:** press the button ②.

The rear side window can be opened or closed as follows:

- The indicator lamp ① is lit: via the switch on the driver's door

- The indicator lamp ① is off: via the switch on the corresponding rear door or driver's door

Occupant presence reminder

Function of the occupant presence reminder

The occupant presence reminder can help to remind you about a child who may have been forgotten in the rear compartment of the vehicle. It activates and deactivates automatically when the rear door is open for an extended period of time and a child, which the system presumes to be present, could enter or exit the vehicle.

When the vehicle is switched off, the **Do Not Leave People or Animals in the Vehicle** message appears on the driver display if the system was already automatically activated.

You can permanently deactivate the function in the multimedia system (→ page 72). When the system is deactivated, the  indicator lamp in the driver display lights up.

Activating or deactivating the occupant presence reminder in the multimedia system

Multimedia system:

→  ▶ Settings ▶ Vehicle

▶▶ Occupant Protection

▶ Activate or deactivate the function.

SmartKey

Overview of key functions

⚠ WARNING Risk of accident and injury due to children left unattended in the vehicle

If you leave children unattended in the vehicle, they could, in particular:

- open doors, thereby endangering other persons or road users.
- get out and be struck by oncoming traffic.
- operate vehicle equipment and become trapped, for example.

In addition, the children could also set the vehicle in motion by, for example:

- releasing the parking brake.
- changing the gearbox position.
- starting the vehicle.

▶ Never leave children unattended in the vehicle.

- ▶ When leaving the vehicle, always take the key with you and lock the vehicle.
- ▶ Keep the key out of reach of children.

This also applies to the Digital Vehicle Key.

⚠ NOTE Damage to the SmartKey caused by magnetic fields



- ▶ Keep the SmartKey away from strong magnetic fields.



Vehicle key with panic alarm

- ① Opens/closes the trunk lid
- ② Unlocks (with embossed surface)

- ③ Locks
- ④ Indicator lamp
- ⑤ Panic alarm

i If indicator lamp ④ does not light up after you press the  or  button, the battery is weak or possibly discharged. Replace the battery as soon as possible.

Replace the key battery (→ page 75).

The key locks and unlocks the following components:

- Doors
- Fuel filler flap
- Socket flap (plug-in hybrid)
- Trunk lid

If the vehicle is not opened within approximately 40 seconds after unlocking, it will lock again. Anti-theft protection will be armed again.

Do not keep the key together with electronic devices or metal objects. This may affect the key's functionality.

Activating/deactivating the acoustic locking verification signal

Multimedia system:

→ [Home] >> Settings >> Vehicle

>> Open/Close

- ▶ Switch the **Acoustic Lock** on or off.

Activating/deactivating the panic alarm

Requirements

- The vehicle is switched off.



- ▶ **To activate:** press button ① for approximately one second. A visual and audible alarm is triggered.
 - ▶ **To deactivate:** briefly press button ① again.
- or
- ▶ Press the Start/Stop button. A key belonging to the vehicle must be detected in the vehicle.

Changing the unlocking settings

Possible unlocking functions of the key:

- Central unlocking
- Unlocking the driver's door and fuel filler flap
- **Plug-in hybrid:** unlocking the driver's door and fuel filler flap/socket flap

- ▶ **To switch between settings:** press the [Unlock] and [Panic] buttons simultaneously for approximately six seconds until the indicator lamp flashes twice.

Options if the unlocking function for the driver's door and fuel filler flap has been selected:

- **To unlock the vehicle centrally:** press the [Unlock] button twice.
- **Vehicles with KEYLESS-GO:** if you touch the inner surface of the door handle on the driver's door, only the driver's door and the fuel filler flap are unlocked.

Options if the unlocking function for the driver's door and fuel filler flap / socket flap has been selected (plug-in hybrid):



- **To unlock the vehicle centrally:** press the [Unlock] button twice.
- **Vehicles with KEYLESS-GO:** if you touch the inner surface of the door handle on the driver's door, only the driver's door and the fuel filler flap / socket flap are unlocked.

Deactivating the function of the key

Vehicles with KEYLESS-GO: if you deactivate the function of the SmartKey, the KEYLESS-GO functions will also be deactivated. Access or drive

authorization by KEYLESS-GO will then no longer be possible with that particular SmartKey. Activate the function of the SmartKey so that all its functions will again be available.

You can also deactivate the function of the SmartKey to reduce the energy consumption of the SmartKey if you do not use the vehicle or a SmartKey for an extended period of time.

- ▶ Press and hold the  button on the SmartKey.
- ▶ With the key button  pressed, immediately press key button  twice in quick succession. The indicator light of the key lights up once briefly and once for a long time.

i The following options for re-activating the SmartKey are available:

- Press any button on the SmartKey.
- Start the vehicle with the SmartKey in the marked space in the center console (→ page 178).

Removing/inserting the emergency key

Removing the emergency key

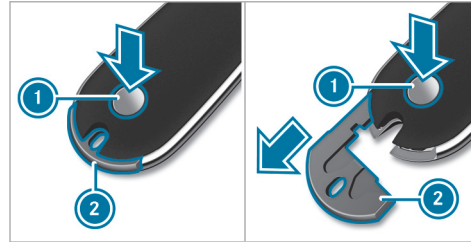

- ▶ Press release knob **1**.
- ▶ Emergency key **2** is pushed out slightly.
- ▶ Fully remove emergency key **2**.

Inserting the emergency key

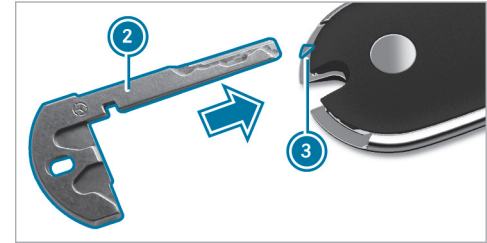

- ▶ Insert emergency key **2** at marking **3** until it engages.
- i** You can use emergency key **2** to attach the key to a key ring.

Replacing the key battery

⚠ DANGER Risk of fatal injuries due to swallowing batteries

Batteries contain toxic and corrosive substances. If batteries are swallowed or otherwise

enter the body, severe internal burns can occur within two hours.

There is a risk of fatal injury.

- ▶ Keep batteries out of the reach of children.
- ▶ If the battery compartment cover and/or lid do not close securely, stop using the key and keep it away from children.
- ▶ If batteries are swallowed or otherwise enter the body, seek immediate medical attention.



ENVIRONMENTAL NOTE Environmental damage due to improper disposal of batteries



Batteries contain pollutants. It is illegal to dispose of them with the household rubbish.



Dispose of batteries in an environmentally responsible manner. Take discharged batteries to a qualified specialist workshop or to a collection point for used batteries.

Requirements

- You require a CR 2032 3 V cell battery.

Mercedes-Benz recommends that you have the battery replaced at a qualified specialist workshop.

- ▶ Remove the emergency key (→ page 75).

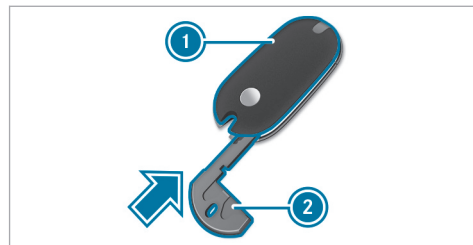

- ▶ Press emergency key ② into the opening in the key in the direction of the arrow until cover ① opens. When doing so, do not hold cover ① closed.

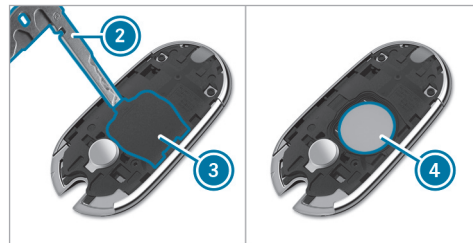

- ▶ Insert emergency key ② into the opening and lift up covering ③ and remove it.
- ▶ Repeatedly tap the key against your palm until battery ④ falls out of the key.
- ▶ Insert the new battery with the positive pole facing upwards. Use a lint-free cloth to do so.
- ▶ Make sure that the surface of the battery is free of lint, grease and other impurities.
- ▶ Insert the front tabs of covering ③ into the housing and then press on both sides to close it.
- ▶ Make sure that covering ③ is completely closed.
- ▶ Insert the front tabs of cover ① into the housing and then press until it is completely closed.
- ▶ Insert the emergency key again (→ page 75).

Problems with the key, troubleshooting

You can no longer lock or unlock the vehicle

Possible causes are:

- The key battery is weak or discharged.
- ▶ Check the battery using the indicator lamp (→ page 73).
- ▶ Replace the key battery, if necessary (→ page 75).
- ▶ Use the replacement key.
- ▶ Use the mechanical key to lock or unlock (→ page 82).
- ▶ Have key checked at a qualified specialist workshop.

There is interference from a powerful radio signal source

Possible causes if the function of the key is impaired:

- high voltage power lines
- mobile phones
- electronic devices (notebooks, tablets)

- shielding due to metal objects or induction loops for electrical gate systems or automatic barriers

- ▶ Make sure that there is sufficient distance between the key and the potential source of interference.

You have lost a key

- ▶ Have the key deactivated at a qualified specialist workshop.
- ▶ If necessary, have the mechanical lock replaced as well.

Digital Vehicle Key

Unlocking and locking the vehicle with the Digital Vehicle Key

Requirements:

- The vehicle is equipped with the "Digital Vehicle Key" pre-installation.
- The "Digital Vehicle Key" function is activated via Mercedes me: <https://www.mercedes.me>.

- Bluetooth® is activated on the end device (with the Digital Vehicle Key activated).
- The end device is sufficiently charged.

The Digital Vehicle Key can be used for the following functions:

- Locking/unlocking the vehicle with KEYLESS-GO (→ page 80)
- HANDS-FREE ACCESS function (→ page 87)
- Convenience closing (closing the vehicle from outside) (→ page 92)
- Anti-theft protection (→ page 98)
- Starting (→ page 176) or shutting off (→ page 220) the vehicle
- Starting the vehicle with the Digital Vehicle Key in the storage compartment (emergency operation mode) (→ page 177)
- Locking and unlocking the vehicle with the NFC function (emergency unlocking)

When the Digital Vehicle Key's rechargeable battery is at extremely low capacity, it is possible to lock and unlock the vehicle with the NFC function (emergency unlocking).

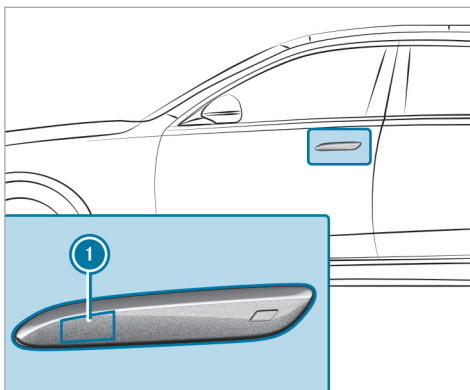

▶ **Locking and unlocking the vehicle with the NFC function:** hold the Digital Vehicle Key against the door handle in close proximity to the NFC antenna ❶ for approximately five to ten seconds.

- ❶ If the Bluetooth® connection is not working, or the rechargeable battery for the Digital Vehicle Key is at very low capacity, it is also

possible to start the vehicle via the NFC function (→ page 177).

Depending on the end device, you can continue to use the KEYLESS-GO function for a certain amount of time, even if the rechargeable battery in the Digital Vehicle Key is at very low capacity.

- ❶ Mercedes-Benz recommends that the key is carried about your person as a security measure against functional restrictions (→ page 75).
- ❶ Mercedes-Benz recommends placing the Digital Vehicle Key in the storage compartment while driving (→ page 177).
- ❶ Refer to the Digital Operator's Manual for more information on the Digital Vehicle Key.

Troubleshooting problems with the Digital Vehicle Key

You can no longer lock and unlock the vehicle with the Digital Vehicle Key.

Possible causes:

- Bluetooth® is deactivated on the Digital Vehicle Key.
 - The rechargeable battery for the Digital Vehicle Key is at low capacity or is flat.
- ▶ Activate Bluetooth® on the Digital Vehicle Key.
 - ▶ Check the state of charge for the Digital Vehicle Key's rechargeable battery.
 - ▶ If necessary, charge the rechargeable battery of the Digital Vehicle Key.
 - ▶ Using the NFC function of the Digital Vehicle Key for locking or unlocking the vehicle (emergency unlocking) (→ page 77).
 - ▶ Use the vehicle key.
 - ▶ Use the emergency key to lock or unlock (→ page 82).

- ▶ Have the vehicle and the Digital Vehicle Key checked at a qualified specialist workshop.

There is interference from a powerful radio signal source.

Possible causes of Digital Vehicle Key impairment:

- high-voltage power lines
 - mobile phones
 - electronic devices (laptops, tablets)
 - shielding due to metal objects or induction loops for electric gate systems or automatic barriers
- ▶ Ensure sufficient distance between the Digital Vehicle Key and any potential source of interference.

You have lost a Digital Vehicle Key.

- ▶ Remove the Digital Vehicle Key.
- i** For information on removing the Digital Vehicle Key, refer to the Digital Operator's Manual.

Doors

Unlocking/opening the doors from the inside

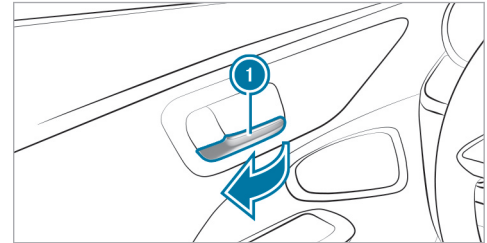

- ▶ **To unlock and open a front door:** pull door handle **1**.
- ▶ **To unlock a rear door:** pull the rear door handle.
- ▶ **To open a rear door:** pull the rear door handle again.

Centrally locking and unlocking the vehicle from the inside

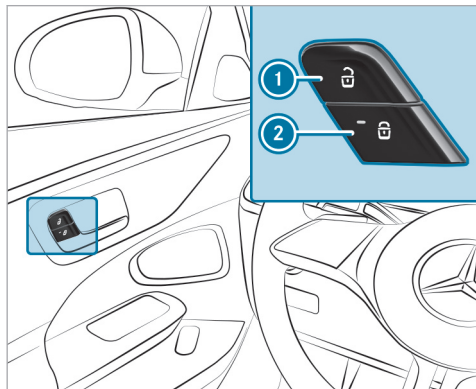

▶ **To unlock:** press the button ①.

▶ **To lock:** press the button ②.
The red indicator lamp on the button ② lights up when the vehicle is locked.

① The buttons are also located on the front passenger door and rear doors.

This does not lock or unlock the fuel filler flap.

Plug-in hybrid: the socket flap is also locked and unlocked. The socket flap can be opened even if a key is detected in the vehicle.

The vehicle is not unlocked when the button ① is pressed:

- If you have locked the vehicle using the key
- If you have locked the vehicle using KEYLESS-GO
- After locking with the NFC function (**vehicles with Digital Vehicle Key:**)

Locking/unlocking the vehicle with KEYLESS-GO

Requirements:

- The key is outside the vehicle.
- The distance between the key and the vehicle does not exceed 3 ft (1 m).
- The driver's door and the door at which the door handle is used are closed.

① **Vehicles with Digital Vehicle Key:** You can use the Digital Vehicle Key in the same way as the conventional vehicle key.

! **NOTE** Damage to the vehicle caused by unintentionally opening the trunk lid

- When using an automatic car wash
- When using a high pressure cleaner

▶ Deactivate the function of the SmartKey in these situations.

or

▶ Make sure that the SmartKey is at a minimum distance of 10 ft (3 m) away from the vehicle.

Vehicles with Digital Vehicle Key:

! **NOTE** Vehicle damage due to unintentional opening of the trunk lid

- when using a car wash
- when using a power washer

▶ In these situations, switch off the Digital Vehicle Key.

or

▶ Ensure that the Digital Vehicle Key is at least 10 ft (3 m) away from the vehicle.

Observe the information:

- on washing the vehicle in a car wash (→ page 370)
- on using a power washer (→ page 373)

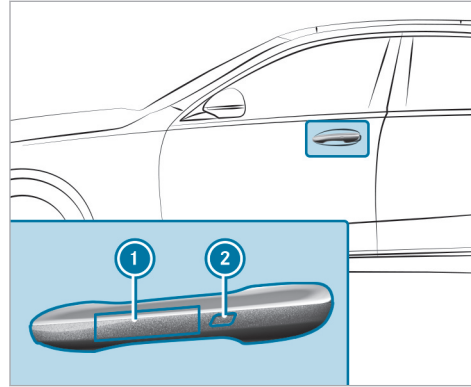

▶ **To unlock the vehicle:** touch the inside surface of the door handle.

▶ **To lock the vehicle:** touch the sensor surface ① or ②.

▶ **Convenience closing:** touch the recessed sensor surface ② for a prolonged period.

① Further information on convenience closing (→ page 92).

Troubleshooting problems with KEYLESS-GO

You can no longer lock or unlock the vehicle using KEYLESS-GO

Possible causes:

- The function of the key has been deactivated. This also applies to the Digital Vehicle Key.
- The key battery is weak or discharged.

Vehicles with Digital Vehicle Key: depending on the respective end device, you can continue to use the KEYLESS-GO function for a certain amount of time even if the rechargeable battery in the Digital Vehicle Key is at very low capacity.

- ▶ Activate the function of the key (→ page 74).
- ▶ Check the battery via the indicator lamp (→ page 73).
- ▶ If necessary, replace the key battery (→ page 75).
- ▶ Use the replacement key.
- ▶ Use the emergency key to lock or unlock (→ page 82).

- ▶ Have the vehicle and key checked at a qualified specialist workshop.

There is interference from a powerful radio signal source.

Possible causes if the function of KEYLESS-GO is impaired:

- high-voltage power lines
 - mobile phones
 - electronic devices (laptops, tablets)
 - shielding due to metallic objects or induction loops for electrical gate systems or automatic barriers
- ▶ Ensure that there is sufficient distance between the key and the potential source of interference.

Activating/deactivating the automatic locking feature

Multimedia system:

- ▶  ▶ Settings ▶ Vehicle
▶▶ Open/Close

- ⓘ The vehicle will be locked automatically when the vehicle is switched on and the wheels are turning faster than walking pace.

- ▶ Activate or deactivate **Automatic Door Lock**.

In the following situations, there is a risk of being locked out when the function is activated:

- If the vehicle is being towed or pushed.
- If the vehicle is being tested on a roller dynamometer.

Locking/unlocking the vehicle with the emergency key

Unlocking a left-hand vehicle door with the emergency key

- ⓘ If you unlock and open the driver's door with the emergency key, this triggers the Anti-Theft Alarm system.
 - ⓘ If you unlock the driver's door with the emergency key, the trunk lid will not be unlocked.
 - ⓘ Information regarding starting the vehicle with the key in the storage compartment (emergency operation mode) (→ page 178). Information regarding starting the vehicle with the Digital Vehicle Key in the storage compartment (emergency operation mode) (→ page 177).
- ▶ Remove the emergency key (→ page 75).

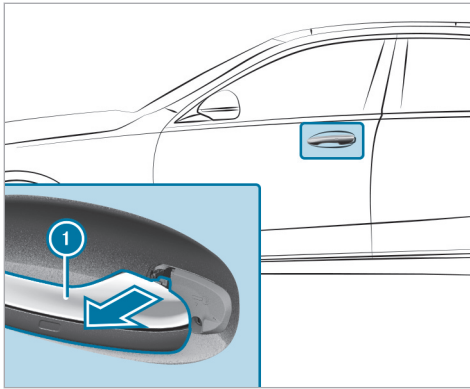

- ▶ Pull and hold the door handle ①.

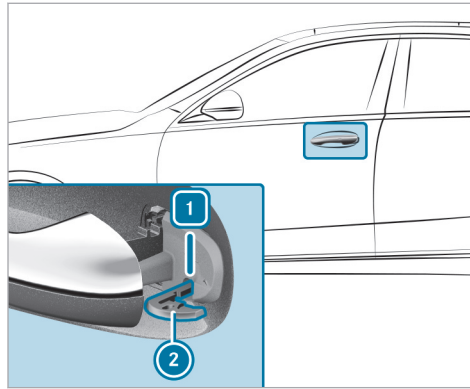

- ▶ Insert the emergency key ② into the lock cylinder as shown.
- ▶ Turn emergency key ② counter-clockwise to position ①.
- ▶ Turn the emergency key ② back to its starting position.
- ▶ Remove the emergency key ② and release the door handle ①.

Locking the doors

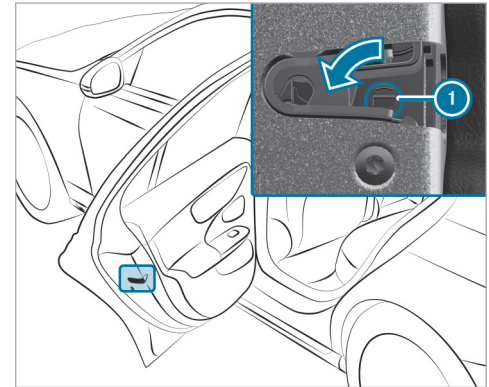

- ▶ Insert a suitable object, e.g. the emergency key, into the opening ① on the door lock.
- ▶ **To lock the left-hand side of the vehicle:** Turn the emergency key counter-clockwise as far as it will go.

- ▶ **To lock the right-hand side of the vehicle:** turn the emergency key clockwise as far as it will go.

If the locked door is then closed, it can no longer be opened from the outside.

Trunk

Opening the trunk lid

⚠ DANGER Risk of exhaust gas poisoning

Combustion engines emit poisonous exhaust gases such as carbon monoxide. Exhaust gases can enter the vehicle interior if the trunk lid is open when the engine is running, especially if the vehicle is in motion.

- ▶ Always switch off the engine before opening the trunk lid.
- ▶ Never drive with the trunk lid open.

- !** **NOTE** Damage to the trunk lid by obstacles above the vehicle

The trunk lid swings upwards when it is opened.

- ▶ Therefore, make sure that there is sufficient clearance above the trunk lid.

- ▶ Pull the trunk lid handle.
- ▶ **Vehicles with HANDS-FREE ACCESS:** Make a kicking movement with your foot below the bumper (→ page 87).

Vehicles with trunk lid convenience closing

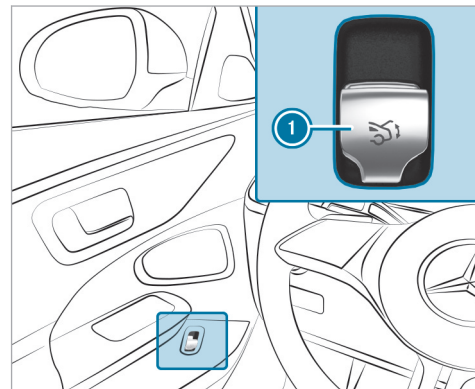

- ▶ Pull remote operating switch ① until the trunk lid opens.

or

- ▶ Press and hold the  button on the Smart-Key.

- ▶ If the trunk lid is stopped in an intermediate position, pull it upwards. Release it as soon as it begins to open.
- ▶ With the trunk lid opening height restriction activated, manually pull the stopped trunk lid upwards.

If an obstacle obstructs the trunk lid during the automatic opening process, blockage detection will stop the trunk lid. The automatic blockage detection function is only an aid and is not a substitute for your attentiveness.

Closing the trunk lid

⚠ WARNING Risk of injury from unsecured items in the vehicle

If objects, luggage or loads are not secured or not secured sufficiently, they could slip, tip over or be thrown around and thereby hit vehicle occupants.

There is a risk of injury, particularly in the event of sudden braking or a sudden change in direction.

- ▶ Always stow objects in such a way that they cannot be thrown around.
- ▶ Before the journey, secure objects, luggage or loads against slipping or tipping over.

Observe the notes on loading the vehicle.

Notes on closing the trunk lid: your vehicle is equipped with automatic key recognition.

Note that the trunk lid will not be locked and will pop back open if the following situation occurs:

- You have locked the vehicle and closed the trunk lid while a key belonging to the vehicle is inside the vehicle and is detected.
and
- A second key belonging to the vehicle is not detected outside the vehicle.

Automatic key recognition is only an aid and is not a substitute for your attentiveness.

- ▶ Before locking, ensure that at least one key belonging to the vehicle is outside the vehicle.

- ▶ **To close the trunk lid:** pull the trunk lid downwards using the handle recess and push it closed.

ⓘ Vehicles with trunk lid convenience closing: if you lightly push the trunk lid closed, the power closing function will automatically pull the trunk lid into the lock.

Vehicles with trunk lid convenience closing

⚠ WARNING Risk of becoming trapped during automatic closing of the trunk lid

Parts of the body could become trapped. There may be people in the closing area.

- ▶ Make sure that nobody is in the vicinity of the closing area.
- ▶ Use one of the following options to stop the closing process:
 - Press the  button on the SmartKey.
 - Press or pull the remote operating switch on the driver's door.
 - Press the closing or locking button on the trunk lid.

- Pull the trunk lid handle.

Vehicles with HANDS-FREE ACCESS: it is also possible to stop the closing process by making a kicking motion below the rear bumper.

- ▶ Pull the trunk lid handle. Release it as soon as it begins to close.
- ▶ If the trunk lid is stopped in an intermediate position, push it downwards. The trunk lid will continue to close.

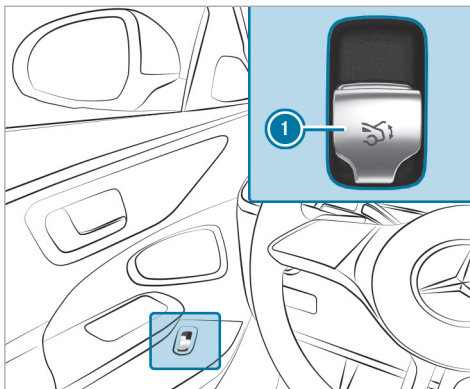

- ▶ Push remote operating switch ① until the trunk lid is fully closed.

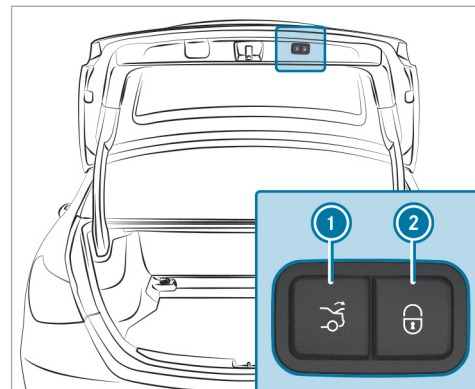

- ▶ Press closing button ① on the trunk lid.

Vehicles with KEYLESS-GO

- ▶ Press locking button ② on the trunk lid. If a key is detected outside the vehicle, the trunk lid will close and the vehicle will be locked.

i Vehicles with Digital Vehicle Key: this also applies to the Digital Vehicle Key if the function is activated and the Digital Vehicle Key is connected to the vehicle.

▶ With the trunk lid completely open, press and hold the  button on the key. The key must be in the vicinity of the vehicle.

Vehicles with HANDS-FREE ACCESS

▶ With the trunk lid completely open, make a kicking movement with your foot below the bumper (→ page 87).

Trunk lid automatic reversing function

The trunk lid is equipped with automatic blockage detection with a reversing function. If an obstacle obstructs the trunk lid during the automatic closing process, it will automatically open again. The automatic reversing function serves solely as an aid and is not a substitute for your attentiveness.

▶ During the closing process, ensure that no body parts remain within the closing area.

⚠ WARNING Risk of becoming trapped despite reversing function

The reversing function will not react:

- to soft, light and thin objects, e.g. fingers
- towards the end of the closing procedure

In these situations in particular, the reversing function cannot prevent someone being trapped.

▶ Ensure that no body parts are in the closing area.

▶ If someone is trapped, use one of the following options:

- Press the  button on the SmartKey.
- Press the remote operating switch on the driver's door.
- Press the closing or locking button on the trunk lid.
- Pull the trunk lid handle.

HANDS-FREE ACCESS function

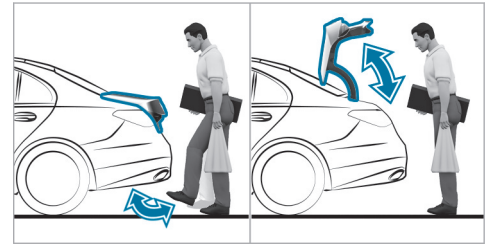

HANDS-FREE ACCESS allows you to open and close the trunk lid, or even stop the opening and closing process at any point, by performing a kicking motion under the bumper. The transmission must be in position **P** for this function.

The kicking motion triggers the opening or closing process alternately.

- If you stop the trunk lid opening process with a kicking motion, the trunk lid is closed with the next kicking motion.

- If you stop the trunk lid closing process with a kicking motion, the trunk lid is opened with the next kicking motion.

In the following cases, the trunk lid can only be closed with HANDS-FREE ACCESS:

- If the vehicle is switched on and the key's unlock function has been set so that only the driver's door is unlocked when activated (→ page 74).
- If the vehicle has been centrally locked from the inside (→ page 80).

Observe the notes when opening (→ page 84) and closing (→ page 85) the trunk lid.

- ⓘ A warning tone sounds while the trunk lid is opening or closing.

⚠ WARNING Risk of burns caused by a hot exhaust system

The vehicle exhaust system can become very hot. If you use HANDS-FREE ACCESS, you could burn yourself by touching the exhaust system.

- ▶ Always ensure that you only make a kicking movement within the detection range of the sensors.

! **NOTE** Damage to the vehicle caused by unintentionally opening the trunk lid

- When using an automatic car wash
- When using a high pressure cleaner
- ▶ Deactivate the function of the SmartKey in these situations.
- or
- ▶ Make sure that the SmartKey is at a minimum distance of 10 ft (3 m) away from the vehicle.

Vehicles with Digital Vehicle Key:

! **NOTE** Vehicle damage due to unintentional opening of the trunk lid

- when using a car wash
- when using a power washer

- ▶ In these situations, switch off the Digital Vehicle Key.

or

- ▶ Ensure that the Digital Vehicle Key is at least 10 ft (3 m) away from the vehicle.

Ensure that you are standing firmly on the ground when performing the kicking motion. You could otherwise lose your balance, e.g. on ice.

Observe the following notes:

- The key is behind the vehicle.
If the key is not recognized:
 - Take the key in your hand.
 - or
 - Ensure that the function of the key is activated (→ page 74).
- **Vehicles with Digital Vehicle Key:** The Digital Vehicle Key is behind the vehicle.
- Stand at least 12 in (30 cm) away from the vehicle when performing the kicking motion.
- Do not come into contact with the bumper when performing the kicking motion.

- Do not carry out the kicking motion too slowly.
- The kicking motion must be towards the vehicle and back again.

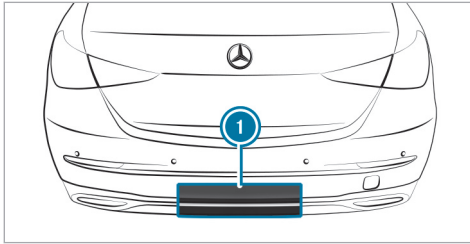

1 Detection range of the sensors

If several consecutive kicking motions are not successful, wait ten seconds.

System limits

The system may be impaired or inoperative in the following cases:

- The sensors are dirty, e.g. due to road salt or snow.

- The kicking motion is performed with a prosthetic leg.

The trunk lid could be opened or closed unintentionally in the following situations:

- A person's arms or legs are moving in the sensor detection range, e.g. when polishing the vehicle or picking up objects.
- Objects are moved or placed behind the vehicle, e.g. the hose of a fuel dispenser, a charging cable or luggage.
- Tension belts, tarps or other covers are pulled over the bumper.
- A protective mat with a length reaching over the loading sill down into the detection range of the sensors is used.
- The protective mat is not secured correctly.

Deactivate the function of the key (→ page 74) or do not carry the key about your person in such situations.

Switching separate trunk locking on and off

Multimedia system:

→ → Settings → Vehicle
→ Open/Close

Switching separate trunk locking on

- ▶ Select **Block Trunk Access**.
- ▶ Create a PIN.
- ▶ Confirm the PIN with **OK**.
- ▶ Enter the PIN again and confirm it. The trunk will remain locked if you unlock the vehicle centrally.

i If an accident has been detected, the trunk will unlock even if separate locking is switched on.

Switching separate trunk locking off

- ▶ Select **Block Trunk Access**.
- ▶ Enter the PIN. If the PIN is correct, separate trunk locking will be switched off and the PIN deleted.

Unlocking and opening the trunk from inside with the emergency release

Requirements

- The 12 V vehicle battery is connected and charged.

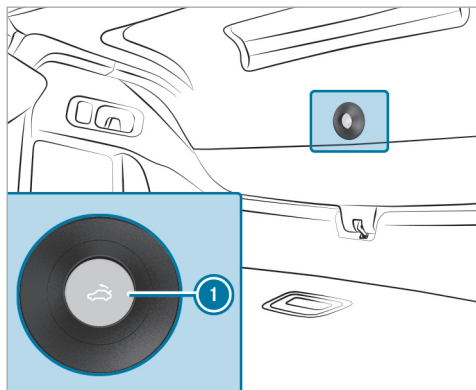

- ▶ Press emergency release button ① briefly.

Activating/deactivating the trunk lid opening height restriction

Multimedia system:

- ▶ ▶ Settings ▶ Vehicle
- ▶▶ Open/Close

- ▶ Activate or deactivate **Opening Height Limiter**.

This function prevents the trunk lid from hitting a low garage ceiling, for example.

Side windows

Opening and closing the side windows

- ▶ **WARNING** Risk of entrapment when opening a side window

When opening a side window, parts of the body could be drawn in or become trapped between the side window and window frame.

- ▶ When opening, make sure that nobody is touching the side window.

- ▶ If someone is trapped, release the button immediately or pull it in order to close the side window again.

- ▶ **WARNING** Risk of becoming trapped when closing a side window

When closing a side window, body parts could be trapped in the closing area in the process.

- ▶ When closing, make sure that no body parts are in the closing area.
- ▶ If someone is trapped, release the button immediately or press the button in order to reopen the side window.

- ▶ **WARNING** Risk of becoming trapped when children operate the side windows

Children could become trapped if they operate the side windows, particularly when unattended.

- ▶ Activate the child safety lock for the rear passenger compartment side windows.

- ▶ When leaving the vehicle, always take the SmartKey with you and lock the vehicle.
- ▶ Never leave children unattended in the vehicle.

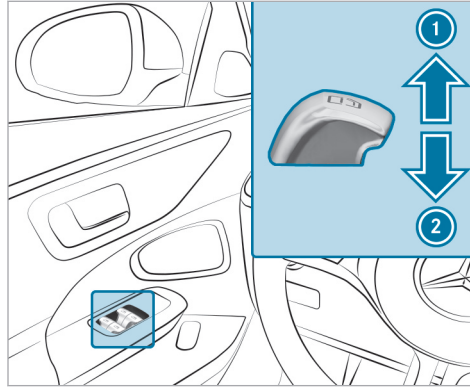

Requirements:

- The power supply of the vehicle has been switched on.



- ① Closing
- ② Opening

The buttons on the driver's door take precedence.

- ▶ **To start automatic operation:** press the  button beyond the pressure point or pull and release it.
- ▶ **To interrupt automatic operation:** press or pull the  button again.

When the vehicle is switched off, you can continue to operate the side windows.

This function is available for around four minutes or until a front door is opened.

Automatic reversing function of the side windows

If an obstacle impedes a side window during the closing process, the side window will open again automatically. The automatic reversing function is only an aid and is not a substitute for your attentiveness.

- ▶ During the closing process, make sure that no body parts are in the closing area.

⚠ WARNING Risk of becoming trapped despite there being reversing protection on the side window

The reversing function does not react:

- To soft, light and thin objects, e.g. fingers.
- During resetting.

The reversing function cannot prevent someone from becoming trapped in these situations.

- ▶ During the closing process, make sure that no body parts are in the closing area.
- ▶ If someone becomes trapped, press the  button to open the side window again.

Convenience opening (ventilating the vehicle before starting a journey)

⚠ WARNING Risk of entrapment when opening a side window

When opening a side window, parts of the body could be drawn in or become trapped between the side window and window frame.

- ▶ When opening, make sure that nobody is touching the side window.
- ▶ Release the button immediately if somebody becomes trapped.

Requirements

- The key is near the vehicle.

▶ Press and hold the  button on the key.

The following functions are performed:

- The vehicle is unlocked.
- The side windows are opened.
- The sliding sunroof is opened.
- The panoramic sliding sunroof is opened.
- The seat ventilation of the driver's seat is switched on.

i If the roller sunblind of the panoramic sliding sunroof is closed, the roller sunblind is opened first.

▶ **Interrupt convenience opening:** Release the button .

▶ **Continue convenience opening:** Press the button  again and hold pressed.

Convenience closing (closing the vehicle from outside)

⚠ WARNING Risk of entrapment due to not paying attention during convenience closing

When the convenience closing feature is operating, parts of the body could become trapped in the closing area of the side window and the sliding sunroof.

- ▶ When the convenience closing feature is operating, monitor the entire closing process and make sure that no body parts are in the closing area.

Requirements

- The key is near the vehicle.
- ▶ Press and hold the  button on the key. The following functions will be performed:
 - The vehicle will be locked.
 - The side windows will be closed.
 - The sliding sunroof will be closed.

- The panoramic sliding sunroof will be closed.

▶ **To interrupt convenience closing:** release the  button.

▶ **To continue convenience closing:** press and hold the  button again.

ⓘ Convenience closing also functions with KEY-LESS-GO (→ page 80).

Resolving problems with the side windows

⚠ WARNING Risk of becoming trapped or fatally injured if reversing protection is not activated

If you close a side window again immediately after it has been blocked, the side window will close with increased or maximum force. The reversing function is then not active and body parts may become trapped.

▶ Make sure that no parts of the body are in the closing area.

▶ To stop the closing process, release the button or press the button again to reopen the side window.

A side window cannot be closed and you cannot see the cause.

- ▶ Check to see whether any objects are in the window guide.
- ▶ Adjust the side windows.

Adjusting the side windows

If a side window is obstructed during closing and reopens again immediately:

- ▶ Immediately after this, pull and hold the corresponding button again until the side window has closed and hold the button for at least one more second (re-adjustment). The side window will be closed without the automatic reversing function.

If the side window is obstructed again and reopens again immediately:

- ▶ Immediately after this, pull and hold the corresponding button again until the side window

has closed and hold the button for at least one more second (follow-up adjustment). The side window will be closed without the automatic reversing function.

The side windows cannot be opened or closed using the convenience opening feature.

Possible causes:

- The key battery is weak or discharged.
- ▶ Check the battery using the indicator lamp (→ page 73).
 - ▶ Replace the key battery, if necessary (→ page 75).

Sliding sunroof

Opening and closing the sliding sunroof

ⓘ The term "sliding sunroof" also refers to the panorama roof with power tilt/sliding panel.

⚠ WARNING Risk of becoming trapped when the sliding sunroof is being opened and closed

Body parts may become trapped in the range of movement.

- ▶ During the opening and closing process, make sure that no body parts are in the sweep of the sliding sunroof.
- ▶ If someone is trapped, release the control panel immediately.

or

- ▶ Touch the control panel during automatic operation. The opening/closing process will be stopped.

⚠ WARNING Risk of becoming trapped if the sliding sunroof is operated by children

Children operating the sliding sunroof could get caught in the moving parts, particularly if unattended.

- ▶ Never leave children unattended in the vehicle.
- ▶ When leaving the vehicle, always take the key with you and lock the vehicle.

⚠ WARNING Risk of becoming trapped when the roller sunblind is being opened and closed

Body parts may become trapped between the roller sunblind and frame or sliding roof.

- ▶ During the opening or closing process, make sure that no body parts are in the roller sunblind's range of movement.
- ▶ If someone is trapped, release the control panel immediately.

or

- ▶ Touch the control panel during automatic operation. The opening/closing process will be stopped.

! NOTE Malfunction due to snow and ice

Snow and ice may cause the sliding sunroof to malfunction.

- ▶ Open the sliding sunroof only if it is free of snow and ice.

! NOTE Damage caused by protruding objects

Objects that protrude from the sliding sunroof may damage the seals.

- ▶ Do not allow anything to protrude from the sliding sunroof.

! NOTE Damage to the sliding sunroof when a roof luggage rack is installed

If the sliding sunroof is opened when a roof luggage rack is installed, the sliding sunroof may be damaged by the roof luggage rack.

- ▶ Do not open the sliding sunroof if a roof luggage rack is installed.

The sliding sunroof may be raised to allow ventilation of the vehicle interior.

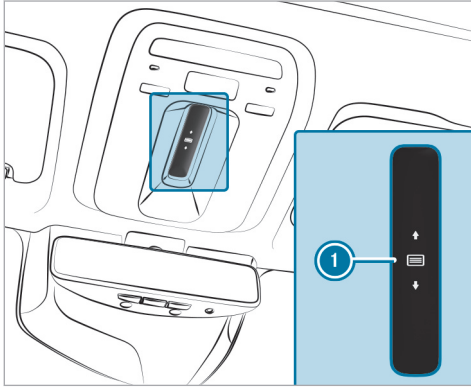

The sliding sunroof and the roller sunblind are operated using control panel ①.

The panorama roof with power tilt/sliding panel can be operated only when the roller sunblind is open.

- ▶ **To open:** swipe backwards across control panel ① and hold it.
- ▶ **To close:** swipe forwards across control panel ① and hold it.
- ▶ **To raise or lower:** press control panel ① briefly.
- ▶ **To start automatic operation:** swipe forwards or backwards across control panel ①.
- ▶ **To cancel automatic operation:** press control panel ① again.
The opening/closing process will be stopped.

Automatic reversing function of the sliding sunroof

If an obstacle obstructs the sliding sunroof during the closing process, the sliding sunroof will open again automatically. The automatic reversing function is only an aid and is not a substitute for your attentiveness.

- ▶ During the closing process, make sure that no body parts are in the closing area.

⚠ WARNING Risk of becoming trapped despite reversing function

The reversing function will not react:

- To soft, light and thin objects, e.g. fingers.
 - Towards the end of the closing procedure.
 - During resetting.
- ▶ During the closing process, make sure that no body parts are in the closing area.
 - ▶ If someone is trapped, release the control panel immediately.
- or
- ▶ Touch the control panel during automatic closing.
The closing process will be stopped.

Automatic reversing function of the roller sunblind

If an obstacle obstructs the roller sunblind during the closing process, the roller sunblind will open again automatically. The automatic reversing function is only an aid and is not a substitute for your attentiveness.

- ▶ When closing the roller sunblind, make sure that no body parts are in the range of movement.

⚠ WARNING Risk of becoming trapped despite reversing function

In particular, the reversing function does not react to soft, light and thin objects, e.g. fingers.

- ▶ When closing the roller sunblind, make sure that no body parts are in the range of movement.
- ▶ If someone is trapped, release the control panel immediately.

or

- ▶ Touch the control panel during automatic closing.
The closing process will be stopped.

Automatic functions of the sliding sunroof

- ① The term "sliding sunroof" also refers to the panorama roof with power tilt/sliding panel.

Rain closing function when driving

Vehicles with a panorama roof with power tilt/sliding panel: if it starts to rain, the raised sliding sunroof will automatically be lowered while the vehicle is in motion.

Automatic lowering function

Vehicles with a panorama roof with power tilt/sliding panel: if the sliding sunroof is raised at the rear, it will automatically be lowered slightly at higher speeds. At low speeds, it will be raised again automatically.

⚠ WARNING Risk of becoming trapped by automatic lowering of the sliding sunroof

At higher speeds, the raised sliding sunroof will automatically be lowered slightly at the rear.

- ▶ Make sure that nobody reaches into the sliding sunroof's range of movement while the vehicle is in motion.
- ▶ If someone becomes trapped, touch the control panel.

Rectifying problems with the sliding sunroof

⚠ WARNING Risk of becoming trapped or fatal injuries when the sliding sunroof is closed again

If you close the sliding sunroof again immediately after it has been blocked or reset, the sliding sunroof will close with increased or maximum force.

There is a risk of becoming trapped or even of fatal injuries!

- ▶ Make sure that no parts of the body are in the closing area.
- ▶ If someone is trapped, release the control panel immediately.

or

- ▶ Touch the control panel during automatic closing.
The closing process will be stopped.

The sliding sunroof cannot be closed and you cannot see the cause.

- ❗ The term "sliding sunroof" also refers to the panorama roof with power tilt/sliding panel.

If the sliding sunroof is obstructed during closing and reopens again slightly:

- ▶ Immediately after automatic reversing, swipe forwards across the control panel (→ page 93) and hold it until the sliding sunroof is closed. The sliding sunroof will be closed with increased force.

If the sliding sunroof is obstructed again and opens again slightly:

- ▶ Repeat the previous step. The sliding sunroof will be closed again with increased force.

Vehicles without a panorama roof with power tilt/sliding panel: the sliding sunroof is not operating smoothly.

- ▶ Reset the sliding sunroof.

Resetting the sliding sunroof

- ▶ Swipe forwards across the control panel (→ page 93) and hold it repeatedly until the sliding sunroof is completely open.
- ▶ Swipe across the control panel and hold it for another second.
- ▶ Close the sliding sunroof.

Vehicles with a panorama roof with power tilt/sliding panel: the sliding sunroof or the roller sunblind is not operating smoothly.

- ▶ Reset the sliding sunroof and the roller sunblind.

Resetting the sliding sunroof and the roller sunblind

- ▶ Swipe forwards across the control panel (→ page 93) and hold it repeatedly until the sliding sunroof is completely closed.
- ▶ Swipe across the control panel and hold it for another second.
- ▶ Swipe across and hold the control panel until the roller sunblind is fully closed.
- ▶ Swipe across the control panel and hold it for another second.

- ▶ Use automatic operation to fully open and then close the sliding sunroof.

Roller sun blinds

Extending the rear side window roller sunblinds

❗ **NOTE** Damage to the inertia reel due to it snapping back

If suddenly snapped back, the inertia reel may be damaged.

- ▶ Always move the roller sun blind by hand.
- ▶ Do not drive with the roller sun blind hooked in and rear side windows opened at the same time.

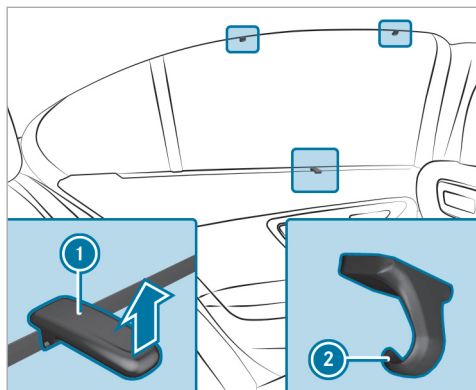

- ▶ Pull the roller sunblind out by tab ① and hook it onto brackets ② at the top of the window.

Extending or retracting the rear window roller sunblind

⚠ WARNING Risk of becoming trapped when extending or retracting the roller sunblind

Body parts may become trapped in the roller sunblind's range of movement.

- ▶ Ensure there are no body parts in the range of movement.
- ▶ If someone becomes trapped, briefly press the button again. The opening or closing process will briefly be stopped. The roller sunblind will then return to its starting position.

! NOTE Damage caused by objects

Objects can cause the roller sunblind to malfunction.

- ▶ Do not place any objects on the rear shelf.
- ▶ Ensure that the roller sunblind can move freely.

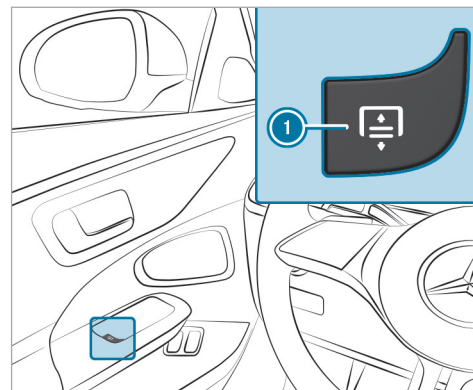

- ▶ To extend or retract: press button ①.

Anti-theft protection

Function of the immobilizer

The immobilizer prevents your vehicle from being started without the correct key.

This also applies to the Digital Vehicle Key.

The immobilizer is automatically activated when the vehicle is switched off and deactivated when the vehicle is switched on.

When leaving the vehicle, always take the key with you and lock the vehicle. Anyone can start the vehicle if a valid key has been left inside the vehicle.

- ❗ If the engine cannot be started even though the starter battery is charged, the immobilizer may be defective. Contact an authorized Mercedes-Benz Center or call 1-800-FOR-MERCEdes (in the USA) or 1-800-387-0100 (in Canada).

ATA (anti-theft alarm system)

■ Function of the ATA system

If the ATA system is armed, a visual and audible alarm will be triggered in the following situations:

- When a door is opened
- When the trunk lid is opened
- When the hood is opened

- When the interior protection is triggered (→ page 101)
 - When the tow-away alarm is triggered (→ page 100)
 - ❗ **Vehicles with Digital Vehicle Key:** The ATA works with the Digital Vehicle Key in the same way as with the conventional vehicle key.
- The ATA system will be armed automatically after approximately ten seconds in the following situations:
- After you lock the vehicle with the key
 - After you lock the vehicle using KEYLESS-GO
 - After you lock the vehicle with the NFC function (**vehicles with Digital Vehicle Key:**)

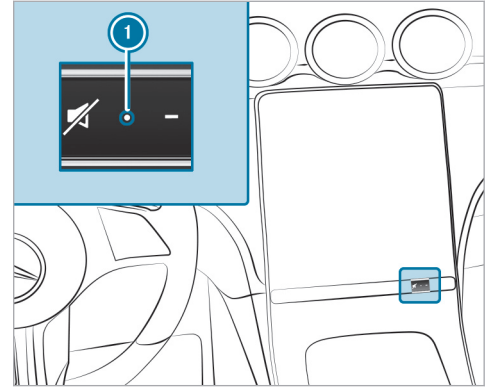

Indicator lamp ❶ will flash when the ATA system is armed.

The ATA system will be disarmed automatically in the following situations:

- After you unlock the vehicle with the key
- After you unlock the vehicle using KEYLESS-GO

- After you unlock the vehicle with the NFC function (**vehicles with Digital Vehicle Key**)
- After you press the Start/Stop button with the key in the marked space (→ page 178)

Deactivating the ATA

▶ Press the ,  or  button on the key.

or

▶ Press the Start/Stop button with the key in the storage compartment (→ page 178)

▶ **Vehicles with Digital Vehicle Key:** Press the Start/Stop button with the Digital Vehicle Key in the storage compartment (→ page 177).

Deactivating the alarm using KEYLESS-GO:

▶ Cover the outside door handle with the key outside the vehicle.
This also applies to the Digital Vehicle Key.

Function of tow-away alarm

 This function may not be available in all countries.

A visual and audible alarm will be triggered if an alteration to your vehicle's angle of inclination is detected while the tow-away alarm is armed.



The tow-away alarm will be armed automatically after about 60 seconds:

- After you lock the vehicle with the key
- After you lock the vehicle using KEYLESS-GO
This also applies to the Digital Vehicle Key.
- After locking with the NFC function (**vehicles with Digital Vehicle Key:**)

The tow-away alarm will be armed only when the following components are closed:

- Doors
- Trunk lid

The tow-away alarm will automatically be deactivated:

- After you press the  or  button on the key
- After you press the start/stop button with the key in the marked space (→ page 178)

- After you press the start/stop button with the Digital Vehicle Key in the marked space (**vehicles with Digital Vehicle Key**) (→ page 177)
- After you unlock the vehicle using KEYLESS-GO
This also applies to the Digital Vehicle Key.
- After unlocking with the NFC function (**vehicles with Digital Vehicle Key**)
- When using HANDS-FREE ACCESS

Information on collision detection on a parked vehicle (→ page 227).

Arming/dearming the tow-away alarm

Multimedia system:

  ▶▶ Settings ▶▶ Vehicle
▶▶ Opening/closing ▶▶ Vehicle Protection

▶ Activate or deactivate **Tow-away Protection**.

The tow-away alarm will be armed again in the following cases:

- The vehicle is unlocked again.
- A door is opened.

- The vehicle is locked again.

Function of interior protection

 This function may not be available in all countries.

When interior protection is armed, a visual and audible alarm will be triggered if movement is detected in the vehicle interior.



Interior protection will be armed automatically after approximately ten seconds:

- After locking the vehicle with the key
- After locking the vehicle using KEYLESS-GO
This also applies to the Digital Vehicle Key.
- After locking with the NFC function (**vehicles with Digital Vehicle Key**)

Interior protection will be armed only when the following components are closed:

- Doors
- Trunk lid

Interior protection will automatically be deactivated:

- After the  or  button on the key is pressed
- After the start/stop button is pressed with the key in the marked space (→ page 178)
- After the start/stop button is pressed with the Digital Vehicle Key in the marked space (**vehicles with Digital Vehicle Key**) (→ page 177)
- After you unlock the vehicle using KEYLESS-GO
This also applies to the Digital Vehicle Key.
- After unlocking with the NFC function (**vehicles with Digital Vehicle Key**)
- When using HANDS-FREE ACCESS

The following situations can lead to a false alarm:

- When there are moving objects such as mascots in the vehicle interior
- If a side window is open
- If the sliding sunroof is open
- If the panoramic sliding sunroof is open

Arming/dearming interior protection

Multimedia system:

- ➔  ➔ Settings ➔ Vehicle
- ➔ Opening/closing ➔ Vehicle Protection
- ▶ Activate or deactivate **Interior Protection**.

Interior protection will be armed again in the following cases:

- The vehicle is unlocked again.
- A door is opened.
- The vehicle is locked again.

Notes on the correct driver's seat position

⚠ WARNING Risk of accident due to adjusting the vehicle settings while the vehicle is in motion

You could lose control of the vehicle in the following situations in particular:

- If you adjust the driver's seat, the head restraint, the steering wheel or the mirror while the vehicle is in motion
- If you fasten your seat belt while the vehicle is in motion

► Before starting the vehicle: in particular, adjust the driver's seat, head restraint, steering wheel and mirror, and fasten your seat belt.

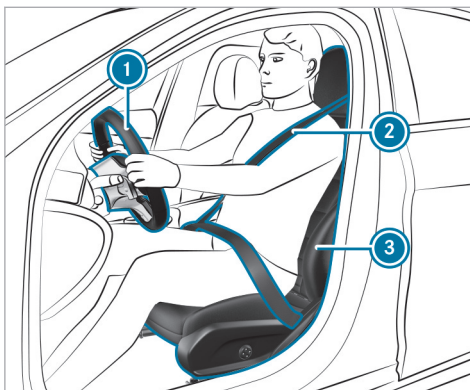

Ensure the following when adjusting steering wheel ①, seat belt ② and driver's seat ③:

- You are sitting as far away from the driver's air bag as possible, taking the following points into consideration:
- You are sitting in an upright position
- Your thighs are slightly supported by the seat cushion

- Your legs are not fully extended and you can depress the pedals properly
- The back of your head is supported at eye level by the center of the head restraint
- You can hold the steering wheel with your arms slightly bent
- You can move your legs freely
- You can see all the displays on the driver display clearly
- You have a good overview of the traffic conditions
- Observe the notes on correctly fastening the seat belt (→ page 42).

Notes on grab handles

⚠ WARNING Risk of injury due to excessive load on the grab handles

If you apply your full body weight to the grab handle or pull it abruptly, the grab handle may be damaged or come loose from its anchorage. This may result in injuries.

- ▶ Use the grab handles only to stabilize the seating position or to assist in getting in and out of the seat.

Seats

Adjusting the front seat mechanically

- ⚠ **WARNING** Risk of becoming trapped if the seats are adjusted by children

Children could become trapped if they adjust the seats, particularly when unattended.

- ▶ When leaving the vehicle, always take the SmartKey with you and lock the vehicle.
- ▶ Never leave children unattended in the vehicle.

- ⚠ **WARNING** Risk of becoming trapped when adjusting the seat

When you adjust a seat, you or other vehicle occupants could become trapped, e.g. on the seat guide rail.

- ▶ When adjusting a seat, make sure that no one has any part of their body within the sweep of the seat.

Observe the safety notes on "Air bags" and "Children in the vehicle".

- ⚠ **WARNING** Risk of accident due to the driver's seat not being engaged

The driver's seat may move unexpectedly while driving.

This could cause you to lose control of the vehicle.

- ▶ Always make sure that the driver's seat is engaged before starting the vehicle.

- ⚠ **WARNING** Risk of accident due to adjusting the vehicle settings while the vehicle is in motion

You could lose control of the vehicle in the following situations in particular:

- If you adjust the driver's seat, the head restraint, the steering wheel or the mirror while the vehicle is in motion
- If you fasten your seat belt while the vehicle is in motion

- ▶ Before starting the vehicle: in particular, adjust the driver's seat, head restraint, steering wheel and mirror, and fasten your seat belt.

- ⚠ **WARNING** Risk of becoming trapped if the seat height is adjusted carelessly

If you adjust the seat height carelessly, you or other vehicle occupants could be trapped and thereby injured.

Children in particular could accidentally press the electrical seat adjustment buttons and become trapped.

- ▶ While moving the seats, make sure that hands or other body parts do not get under the lever assembly of the seat adjustment system.

⚠ WARNING Risk of injury due to head restraints not being installed or being adjusted incorrectly

If head restraints have not been installed or have not been adjusted correctly, there is an increased risk of injury in the head and neck area, e.g. in the event of an accident or when braking.

- ▶ Always drive with the head restraints installed.
- ▶ Before driving off, make sure for every vehicle occupant that the center of the head restraint supports the back of the head at about eye level.

Adjust the head restraint fore-and-aft position so that it is as close as possible to the back of your head.

⚠ WARNING Risk of injury or death due to an incorrect seat position

The seat belt does not offer the intended level of protection if you have not moved the seat backrest to an almost vertical position.

In particular, you could slip beneath the seat-belt and become injured.

- ▶ Adjust the seat properly before beginning your journey.
- ▶ Always ensure that the seat backrest is in an almost vertical position and that the shoulder belt is routed across the center of your shoulder.

⚠ WARNING Risk of potentially fatal injuries due to objects trapped under the front passenger seat

Objects trapped under the front passenger seat may interfere with the function of the

automatic front passenger air bag shutoff or damage the system.

- ▶ Do not stow any objects under the front passenger seat.
- ▶ When the front passenger seat is occupied, ensure that no objects have become trapped beneath the front passenger seat.

⚠ WARNING Risk of injury due to excessive load on the grab handles

If you apply your full body weight to the grab handle or pull it abruptly, the grab handle may be damaged or come loose from its anchorage. This may result in injuries.

- ▶ Use the grab handles only to stabilize the seating position or to assist in getting in and out of the seat.

! **NOTE** Damage to the seats when adjusting

The seats may be damaged by objects when adjusting the seats.

- ▶ When adjusting the seats, make sure that there are no objects in the footwell, under or behind the seats.

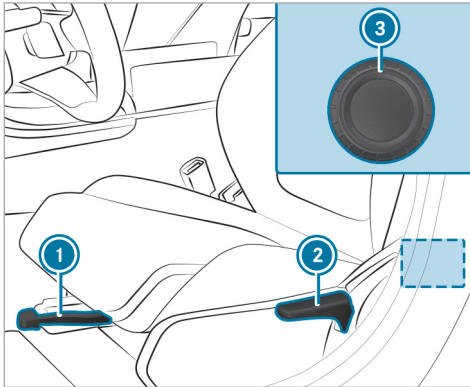

- ▶ **To adjust the seat fore-and-aft position:** lift lever ① and slide the seat into the desired position.
- ▶ Make sure that the seat is engaged.

- ▶ **To adjust the seat height:** push or pull lever ② until the desired seat height has been reached.
- ▶ **To set the seat backrest inclination:** rotate handwheel ③ forwards or backwards until the required position has been reached.

Adjusting the front seat electrically

- ⚠ **WARNING** Risk of becoming trapped if the seats are adjusted by children

Children could become trapped if they adjust the seats, particularly when unattended.

- ▶ When leaving the vehicle, always take the SmartKey with you and lock the vehicle.
- ▶ Never leave children unattended in the vehicle.

You can adjust the seats when the vehicle is switched off.

- ⚠ **WARNING** Risk of becoming trapped if the seats are adjusted

When adjusting a seat, you may trap yourself or a vehicle occupant, e.g. on the seat guide rail.

- ▶ Make sure that no part of the body is within the seat's range of motion when adjusting a seat.

Observe the safety notes on "Air bags" and "Children in the vehicle".

- ⚠ **WARNING** Risk of accident due to adjusting the vehicle settings while the vehicle is in motion

You could lose control of the vehicle in the following situations in particular:

- If you adjust the driver's seat, the head restraint, the steering wheel or the mirror while the vehicle is in motion
- If you fasten your seat belt while the vehicle is in motion

- ▶ Before starting the vehicle: in particular, adjust the driver's seat, head restraint, steering wheel and mirror, and fasten your seat belt.

⚠ WARNING Risk of becoming trapped if the seat height is adjusted carelessly

If you adjust the seat height carelessly, you or other vehicle occupants could be trapped and thereby injured.

Children in particular could accidentally press the electrical seat adjustment buttons and become trapped.

- ▶ While moving the seats, make sure that hands or other body parts do not get under the lever assembly of the seat adjustment system.

⚠ WARNING Risk of injury due to head restraints not being installed or being adjusted incorrectly

If head restraints have not been installed or have not been adjusted correctly, there is an increased risk of injury in the head and neck area, e.g. in the event of an accident or when braking.

- ▶ Always drive with the head restraints installed.
- ▶ Before driving off, make sure for every vehicle occupant that the center of the head restraint supports the back of the head at about eye level.

Adjust the head restraint fore-and-aft position so that it is as close as possible to the back of your head.

⚠ WARNING Risk of injury or death due to an incorrect seat position

The seat belt does not offer the intended level of protection if you have not moved the seat backrest to an almost vertical position.

In particular, you could slip beneath the seat-belt and become injured.

- ▶ Adjust the seat properly before beginning your journey.
- ▶ Always ensure that the seat backrest is in an almost vertical position and that the shoulder belt is routed across the center of your shoulder.

⚠ WARNING Risk of potentially fatal injuries due to objects trapped under the front passenger seat

Objects trapped under the front passenger seat may interfere with the function of the automatic front passenger air bag shutoff or damage the system.

- ▶ Do not stow any objects under the front passenger seat.
- ▶ When the front passenger seat is occupied, ensure that no objects have become trapped beneath the front passenger seat.

! **NOTE** Damage to the seats when adjusting

The seats may be damaged by objects when adjusting the seats.

- ▶ When adjusting the seats, make sure that there are no objects in the footwell, under or behind the seats.

The switches for adjusting the seats do not move. You will therefore receive no direct feedback on the switch while pressing it. Feedback is provided only by the movement of the seat.

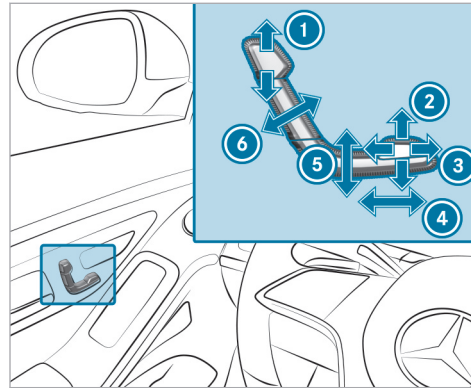

- ① Head restraint height
 - ② Seat cushion inclination
 - ③ Seat cushion length
 - ④ Seat fore-and-aft position
 - ⑤ Seat height
 - ⑥ Seat backrest inclination
- ▶ Save the settings with the memory function (→ page 119).

- ① The head restraint height will be adjusted automatically when you adjust the seat height or the seat fore-and-aft position.

Adjusting the 4-way lumbar support

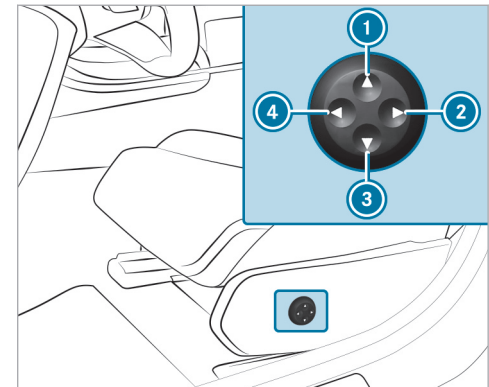

- ① Higher
- ② Softer

- ③ Lower
- ④ Firmer

▶ Use buttons ① to ④ to adjust the contour of the backrest.

Head restraints

■ Adjusting the front seat head restraints mechanically (two-way head restraints)

⚠ WARNING Risk of accident due to adjusting the vehicle settings while the vehicle is in motion

You could lose control of the vehicle in the following situations in particular:

- If you adjust the driver's seat, the head restraint, the steering wheel or the mirror while the vehicle is in motion
 - If you fasten your seat belt while the vehicle is in motion
- ▶ Before starting the vehicle: in particular, adjust the driver's seat, head restraint,

steering wheel and mirror, and fasten your seat belt.

⚠ WARNING Risk of injury due to head restraints not being installed or being adjusted incorrectly

If head restraints have not been installed or have not been adjusted correctly, there is an increased risk of injury in the head and neck area, e.g. in the event of an accident or when braking.

- ▶ Always drive with the head restraints installed.
- ▶ Before driving off, make sure for every vehicle occupant that the center of the head restraint supports the back of the head at about eye level.

Adjust the head restraint fore-and-aft position so that it is as close as possible to the back of your head.

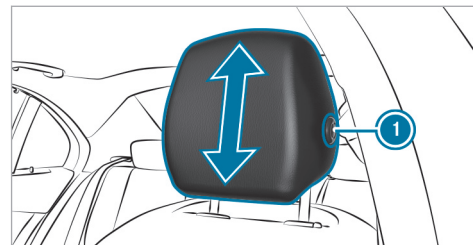

- ▶ Take hold of the head restraint on both sides and press release knob ①.
- ▶ **To raise or lower:** pull the head restraint upwards or push it downwards.
- ▶ Let go of release knob ①.

Adjusting the front seat head restraints mechanically (4-way head restraint)

Vehicles with manual and electric seat adjustment

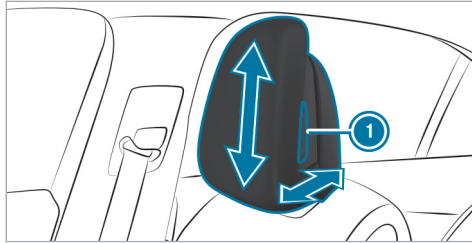

- ▶ Take hold of the head restraint on both sides and press release knob ①. The head restraint will be unlocked in all directions of movement simultaneously.
- ▶ **To raise or lower:** pull the head restraint upwards or push it downwards.
- ▶ **To move forwards or backwards:** pull the head restraint forwards or push it backwards.
- ▶ Let go of release knob ①.

Vehicles with electric seat adjustment

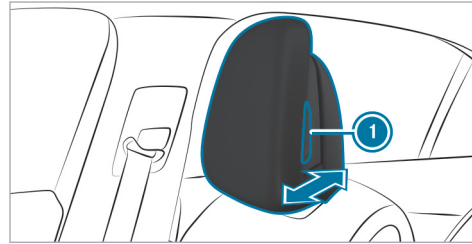

- ▶ **To raise or lower:** adjust the head restraint using the buttons on the door operating unit (→ page 105).
- ▶ **To move forwards or backwards:** take hold of the head restraint on both sides and press release knob ①.
- ▶ Pull the headrest forwards or push it backwards.
- ▶ Let go of release knob ①.

Adjusting the head restraints of the rear seats manually

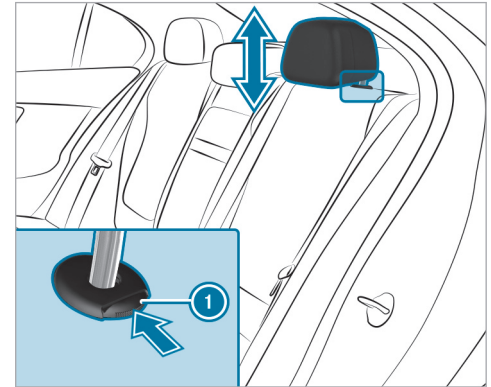

- ▶ **To raise:** push release knob ① in the direction of the arrow and pull the head restraint up until it engages.
- ▶ **To lower:** press release knob ① in the direction of the arrow and push the head restraint down until it engages.

Installing/removing the rear seat head restraints

Removing

You can remove the head restraints only in vehicles with folding rear seat backrests.

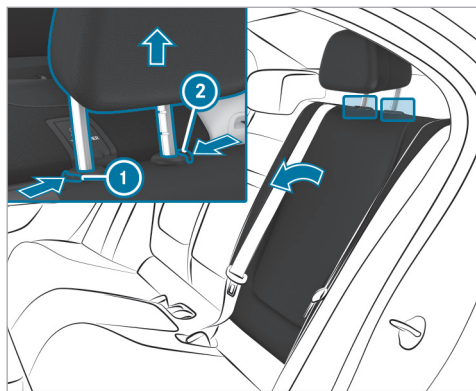

- ▶ Release the rear seat backrest and fold it forwards slightly (→ page 125).

- ▶ Press release knob ② and pull the head restraint upwards as far as it will go. Release knob ① will extend.
- ▶ Push both release knobs ① and ② at the same time in the direction of the arrow and pull out the head restraint.
- ▶ Fold the rear seat backrest back until it engages.

Installing

- ▶ Release the rear seat backrest and fold it forwards slightly (→ page 125).
- ▶ Insert the head restraint such that the notches on the bar are on the left when viewed in the direction of travel.
- ▶ Push the head restraint down until it engages.
- ▶ Fold the rear seat backrest back until it engages.

Configuring the seat settings

Multimedia system:

→ ▶▶ Comfort ▶▶ Seat

Adjusting the air cushions

- ▶ On the corresponding menu, adjust the air cushions for **Lumbar** or **Side Bolsters**.

Setting automatic seat adjustment

⚠ WARNING Risk of becoming trapped during adjustment of the driver's seat after calling up a driver profile

Selecting a user profile may trigger an adjustment of the driver's seat to the position saved under the user profile. You or other vehicle occupants could be injured in the process.

- ▶ Make sure that when the position of driver's seat is being adjusted using the multimedia system, no people or body parts are in the seat's range of movement.

If there is a risk of someone becoming trapped, immediately stop the adjustment process by:

- ▶ a) Pressing the warning message on the central display.
- or
- ▶ b) Pressing a position button of the memory function or a seat adjustment switch in the driver's door.
- The adjustment process is stopped.

Multimedia system:

↳  ▶▶ Comfort ▶▶ Seat
▶▶ Automatic Seat Positioning

Manually adjusting driver's seat and steering wheel position to body size

The vehicle will calculate suitable driver's seat and steering wheel positions on the basis of the driver's body size and set this directly.

- ▶ **To set the unit of measurement:** select **cm** or **ft/in**.
- ▶ Set the size using the scale.

- ▶ Select **Start Positioning**.
The driver's seat and steering wheel positions will be adjusted to the body size that has been set.
- ① You can also configure these settings via the Mercedes me user account for your user profile. By synchronizing the profiles in the vehicle and the Mercedes me connect profiles, you can carry over these settings for your vehicle.
- ① You can change the driver's seat and steering wheel position set by the vehicle using control buttons. You can adjust the outside mirrors to suit using operating switch (→ page 155).

Overview of massage programs

- **Classic Massage** Relaxing back massage
- **Mobilizing Massage** Mobilizing Massage with upward-moving massage waves. Can promote slower, deeper respiration. This can improve the supply of oxygen to cells and the brain.
- **Activating Massage** Activating massage with upward-moving massage waves

- **Relaxing Massage** Relaxing back massage with ascending wave-like movements and then soothing movements
- **Deep Waves** Wave-like movements in the cushion can promote blood flow and metabolic processes in the lower back and legs
- **Deep Workout** Wave-like movements in the cushion are combined with wave-like movements from the backrest and can stimulate blood circulation and metabolism in the lower back, buttocks and legs
- ① The **Deep Waves** and **Deep Workout** programs are available only for the driver's seat.

Selecting a massage program for the front seats

Multimedia system:

↳  ▶▶ Comfort

- ▶ Select **Massage**.
- ▶ Select a massage program (→ page 111).
- ▶ Start the program for the desired seat with .

▶ **To set the massage intensity:** switch **Intensive** on or off.

▶ **To stop the massage:** select .

❗ The availability of this function is equipment-dependent.

Resetting seat settings

Multimedia system:

➔  ▶▶ **Comfort** ▶▶ **Seat**

▶ Select **Reset**.

▶ Select  for the desired seat.

Switching the seat heating on/off

⚠ WARNING Risk of burns due to repeatedly switching on the seat heating

Repeatedly switching on the seat heating can cause the seat cushion and seat backrest padding to become very hot.

In particular, the health of persons with limited temperature sensitivity or a limited ability to

react to high temperatures may be affected or they may even suffer burn-like injuries.

▶ Do not repeatedly switch on the seat heating.

To protect against overheating, the seat heating may be temporarily deactivated after it has been switched on repeatedly.

! **NOTE** Damage to the seats caused by objects or documents when the seat heating is switched on

When the seat heating is switched on, overheating may occur due to objects or documents placed on the seats, e.g. seat cushions or child seats. This could cause damage to the seat surface.

▶ Make sure that no objects or documents are on the seats when the seat heating is switched on.

Requirements

- The power supply is switched on.

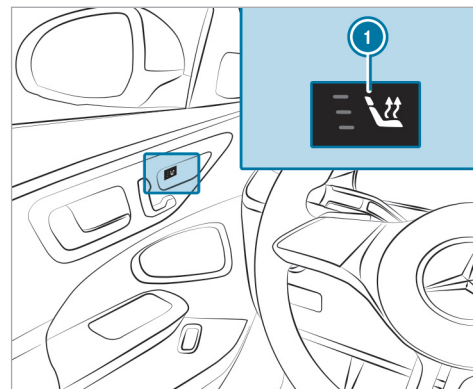

- ▶ Press button **1** for the respective seat repeatedly until the desired heating level is reached. Depending on the heating level, up to three indicator lamps will light up. If all indicator lamps are off, the seat heating is switched off.

- ❶ The seat heating will automatically switch down from the three heating levels after around 8, 10 and 20 minutes until the seat heating is switched off.
- ❷ If you switch the power supply off and on again within 20 minutes, the previous setting of the seat heating for the driver's seat will remain active.

Switching the seat ventilation on/off

Requirements

- The power supply is switched on.

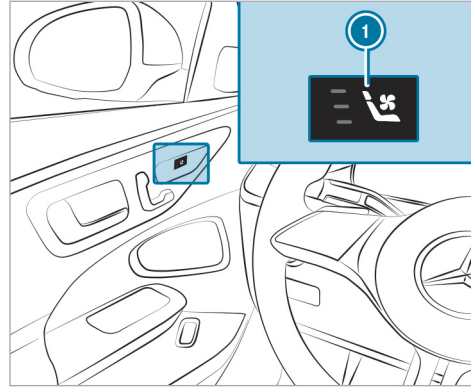

- ▶ Press button ❶ for the respective seat repeatedly until the desired blower setting is reached. Depending on the blower setting, up to three indicator lamps will light up. If all indicator lamps are off, the seat ventilation is switched off.
- ❶ If you switch the power supply off and on again within 20 minutes, the previous seat

ventilation setting for the driver's seat will remain active.

Steering wheel

Adjusting the steering wheel manually

⚠ WARNING Risk of accident due to adjusting the vehicle settings while the vehicle is in motion

You could lose control of the vehicle in the following situations in particular:

- If you adjust the driver's seat, the head restraint, the steering wheel or the mirror while the vehicle is in motion
- If you fasten your seat belt while the vehicle is in motion

▶ Before starting the vehicle: in particular, adjust the driver's seat, head restraint, steering wheel and mirror, and fasten your seat belt.

⚠ WARNING Risk of entrapment for children when adjusting the steering wheel

Children could injure themselves if they adjust the steering wheel.

- ▶ Never leave children unattended in the vehicle.
- ▶ When leaving the vehicle, always take the key with you and lock the vehicle.

Unlocking

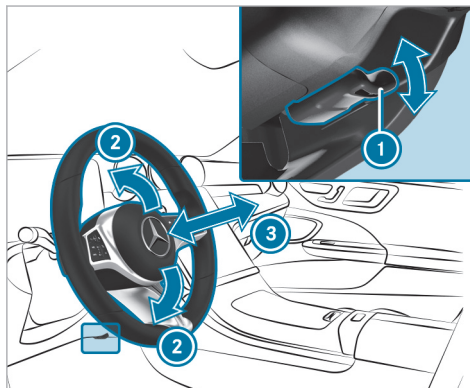

- ▶ Fold release lever ① down as far as it will go.
- ▶ Adjust height ② and distance ③ to the steering wheel.

Locking

- ▶ Fold release lever ① up as far as it will go.

- ▶ Check and make sure that the steering column is locked by moving the steering wheel.

Adjusting the steering wheel electrically

⚠ WARNING Risk of accident due to adjusting the vehicle settings while the vehicle is in motion

You could lose control of the vehicle in the following situations in particular:

- If you adjust the driver's seat, the head restraint, the steering wheel or the mirror while the vehicle is in motion
 - If you fasten your seat belt while the vehicle is in motion
- ▶ Before starting the vehicle: in particular, adjust the driver's seat, head restraint, steering wheel and mirror, and fasten your seat belt.

⚠ WARNING Risk of entrapment for children when adjusting the steering wheel

Children could injure themselves if they adjust the steering wheel.

- ▶ Never leave children unattended in the vehicle.
- ▶ When leaving the vehicle, always take the key with you and lock the vehicle.

The steering wheel can be adjusted when the power supply is disconnected.

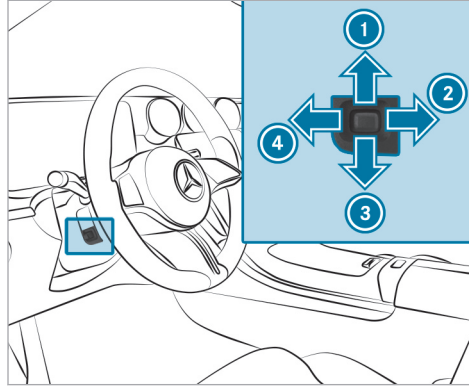

- ① To move up
- ② To move back
- ③ To move down
- ④ To move forward

▶ Save the settings with the memory function (→ page 119).

Switching the steering wheel heater on/off

Depending on the vehicle version, the steering wheel heater can be switched on/off via a switch on the steering wheel.

Requirements

- The vehicle is switched on.

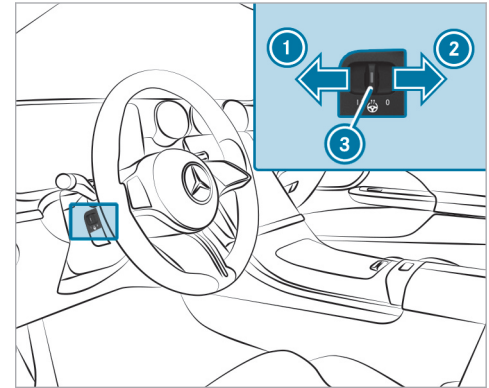

▶ **To switch on:** push the switch to position ①.
If indicator lamp ③ lights up, the steering wheel heater is switched on.

▶ **To switch off:** push the switch to position ②.

When you switch the vehicle off, the steering wheel heater will switch off.

Decoupling the steering wheel heater from the seat heating

Requirements

- The power supply or the vehicle has been switched on.
- The steering wheel heater and the seat heating are linked.

Multimedia system:

→  ▶▶ Comfort ▶▶ Seat
▶▶ Heating Settings

The function is active by default and the steering wheel heater is automatically activated and deactivated when the seat heating is switched on and off.

▶ Tap on **Additional Steering Wheel Heating**.
The steering wheel heater will be decoupled from the seat heating.

Easy entry and exit feature

Using the easy entry and exit feature

⚠ WARNING Risk of accident when pulling away during the adjustment process of the easy entry and exit feature

You could lose control of the vehicle.

- ▶ Always wait until the adjustment process is complete before driving off.

⚠ WARNING Risk of becoming trapped when adjusting the easy entry and exit feature

You and other vehicle occupants, particularly children, may become trapped.

- ▶ Make sure that no one has any part of their body within the range of movement of the steering wheel and driver's seat.

If there is a risk of becoming trapped by the steering wheel:

- ▶ Move the steering wheel adjustment lever.
The adjustment process is stopped.

If there is a risk of becoming trapped by the driver's seat:

- ▶ Press the switch for seat adjustment.
The adjustment process is stopped.
- ▶ Never leave children unattended in the vehicle.
- ▶ When leaving the vehicle, always take the key with you and lock the vehicle.

Vehicles with memory function: you can stop the adjustment process by pressing one of the memory function position switches.

⚠ WARNING Risk of becoming trapped if children activate the easy entry and exit feature

Children could become trapped if they activate the easy entry and exit feature, particularly when unattended.

- ▶ Never leave children unattended in the vehicle.
- ▶ When leaving the vehicle, always take the key with you and lock the vehicle.

In order to use the easy entry and exit feature, the automatic seat adjustment function must have been switched on (→ page 110).

When the easy entry and exit feature is active, the steering wheel and driver's seat will move as follows:

- The steering wheel will move upwards.
- The driver's seat will move forward or backward to a position suitable for getting in or out of the vehicle.

This will occur in the following situations:

- You switch off the vehicle when the driver's door is open.
 - You open the driver's door when the vehicle is switched off.
- ① The steering wheel will then move upwards only if it is not already as high as it will go. The driver's seat will move forwards or backwards only if it is not already in the ideal position for getting in or out of the vehicle.

The steering wheel and the driver's seat will move back to the last driving position in the following cases:

- You switch the power supply or the vehicle on when the driver's door is closed.
- You close the driver's door when the vehicle is switched on.

The last drive position will be saved when:

- If you switch off the vehicle.
- **Vehicles with memory function:** you call up the seat settings via the memory function.

- **Vehicles with memory function:** you save the seat settings via the memory function.

Vehicles with memory function: press one of the memory function position switches to stop the adjustment process.

Setting the easy entry and exit feature

Requirements:

- The automatic seat adjustment has been activated (→ page 110).

Multimedia system:

➔  ➔ Settings ➔ Vehicle

➔ Easy Entry And Exit Feature

▶ Select **Steering Wheel & Seat, Steering Wheel Only or Off.**

- ① If you are using a custom user profile, this information will be used for the easy entry and exit feature. This will cause the driver's seat and steering wheel to move into the correct position automatically.

Memory function

Function of the memory function

⚠ WARNING Risk of an accident if the memory function is used while driving

If you use the memory function on the driver's side while driving, you could lose control of the vehicle as a result of the adjustments being made.

- ▶ Only use the memory function on the driver's side when the vehicle is stationary.

⚠ WARNING Risk of entrapment when adjusting the seat with the memory function

When the memory function adjusts the seat, you and other vehicle occupants – particularly children – could become trapped.

- ▶ During the adjusting process of the memory function, ensure that no body

parts are in the area of movement of the seat or the steering wheel.

- ▶ If someone becomes trapped, press a preset position button or seat adjustment switch immediately. The adjustment process is stopped.

⚠ WARNING Danger of entrapment when memory function is activated by children

When children activate the memory function, they can get trapped, especially if they are unsupervised.

- ▶ Never leave children unattended in the vehicle.
- ▶ When leaving the vehicle, always take the key with you and lock the vehicle.

You can use the memory function when the vehicle is switched off.

Seat adjustments for up to three people can be stored and called up using the memory function.

You can save the following settings for the front seat:

- Seat, backrest, head restraint position and contour of the seat backrest in the lumbar region
- Seat heating: distribution of the heated sections of the seat cushion and seat backrest
- Driver's side: steering wheel position and position of the outside mirrors on the driver's and front passenger sides
- Head-up display

Operating the memory function

Storing

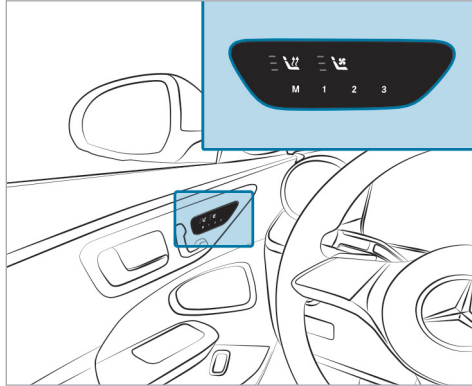

- ▶ Set the front seat, the steering wheel, the head-up display and the outside mirror to the desired position.
- ▶ Press the **[M]** button and then release it.

- ▶ Press one of the preset position buttons **[1]**, **[2]** or **[3]** within three seconds. An acoustic signal sounds. The settings are stored.
- ▶ **To call up:** press the preset position button **[1]**, **[2]** or **[3]**. The seat will be moved to the stored position. After releasing the button, the front seat, outside mirror, head-up display and steering column will continue to move into the stored position automatically.

Stowage areas

Notes on loading the vehicle

⚠ DANGER Risk of exhaust gas poisoning

Combustion engines emit poisonous exhaust gases such as carbon monoxide. Exhaust gases can enter the vehicle interior if the trunk lid is open when the engine is running, especially if the vehicle is in motion.

- ▶ Always switch off the engine before opening the trunk lid.

- ▶ Never drive with the trunk lid open.

Objects in the deployment area of an air bag may prevent the air bag from functioning correctly. Observe the notes on air bags in this regard (→ page 57).

⚠ WARNING Risk of injury from unsecured items in the vehicle

If objects, luggage or loads are not secured or not secured sufficiently, they could slip, tip over or be thrown around and thereby hit vehicle occupants.

There is a risk of injury, particularly in the event of sudden braking or a sudden change in direction.

- ▶ Always stow objects in such a way that they cannot be thrown around.
- ▶ Before the journey, secure objects, luggage or loads against slipping or tipping over.

▲ WARNING Risk of injury due to objects being stowed incorrectly

If objects in the vehicle interior are stowed incorrectly, they can slide or be thrown around and hit vehicle occupants. In addition, cup holders, open storage spaces and mobile phone brackets cannot always retain all objects they contain.

There is a risk of injury, particularly in the event of sudden braking or a sudden change in direction.

- ▶ Always stow objects in such a way that they cannot be thrown around in such situations.
- ▶ Always make sure that objects do not protrude from storage spaces, parcel nets or storage nets.
- ▶ Close the lockable storage spaces before starting a journey.
- ▶ Always stow and secure heavy, hard, pointed, sharp-edged, fragile or bulky objects in the trunk.

▲ WARNING Risk of accident due to objects in the driver's and front-passenger footwell

Objects in the driver's and front-passenger footwell may impede pedal travel or block a depressed pedal.

This jeopardizes the operating- and road safety of the vehicle.

- ▶ Stow all objects in the vehicle securely so that they cannot get into the driver's or front-passenger footwell.
- ▶ Always ensure that the pedals have sufficient free space.
- ▶ Always install the floor mats securely and as prescribed.
- ▶ Do not use loose floor mats and do not place floor mats on top of one another.

Vehicles with automatic front passenger air bag deactivation: objects trapped under the front passenger seat may interfere with the function of the automatic front passenger air bag deactivation or damage the system. Therefore please

observe the notes on the function of automatic front passenger air bag deactivation (→ page 47).

▲ WARNING - Risk of accident or injury when using the cup holder while the vehicle is moving

The cup holder cannot secure containers while the vehicle is moving.

If you use a cup holder while the vehicle is moving, the container may be flung around and liquids may be spilled. The vehicle occupants may come into contact with the liquid and if it is hot, they could be scalded. You could be distracted from traffic conditions and you may lose control of the vehicle.

- ▶ Only use the cup holder when the vehicle is stationary.
- ▶ Only use the cup holder for containers of the right size.
- ▶ Close the container, particularly if the liquid is hot.

! **NOTE** Damage to the cup holder

The cup holder can be damaged when folding back the rear armrest. When open, the cup holder can be damaged by body weight.

- ▶ The rear armrest can only be folded back when the cup holder is closed.
- ▶ Do not sit or support yourself on the cup holder when it is open.

! **NOTE** Damage to the vehicle caused by spilled liquids

If liquids are spilled in the vehicle, parts of the vehicle may be damaged.

- ▶ Always securely close containers containing liquids that you have brought with you.
- ▶ Clean the vehicle as soon as possible if liquids are spilled.
- ▶ If larger quantities of liquids are spilled, have the vehicle checked in a qualified specialist workshop.

! **NOTE** Damage to the rear armrest due to body weight

When folded out, the rear armrest can be damaged by body weight.

- ▶ Do not sit or support yourself on the rear seat armrest.

! **NOTE** Damage to the handle in the trunk floor

If the handle in the trunk is left protruding, the handle may be damaged.

- ▶ Before closing the trunk lid, detach the handle and press it down closed again.

! **NOTE** Damage to the stowage compartment under the ashtray due to intense heat

The stowage compartment under the ashtray is not heat resistant and could be damaged if you rest a lit cigarette on it.

- ▶ Make sure that the ashtray is fully engaged.

! **WARNING** Risk of burns from the tailpipe and tailpipe trims

The exhaust tailpipe and tailpipe trims can become very hot. If you come into contact with these parts of the vehicle, you could burn yourself.

- ▶ Always be particularly careful around the tailpipe and the tailpipe trims and supervise children especially closely in this area.
- ▶ Allow vehicle parts to cool down before touching them.

- ① Leather is a natural product. It exhibits natural surface characteristics, such as differences in structure, marks caused by growth and injury or subtle color differences. These surface characteristics are particular to leather, and are not material defects. Leather is also subject to a natural aging process that changes the surface characteristics.

The driving characteristics of your vehicle are dependent on the distribution of the load within the vehicle. You should bear the following in mind when loading the vehicle:

- Never allow the payload including occupants to exceed the gross vehicle weight rating or the gross axle weight rating for the vehicle. The values are specified on the vehicle identification plate on the vehicle's B-pillar.
- The load must not protrude above the upper edge of the seat backrests.
- Always place the load behind unoccupied seats if possible.
- Secure the load using the tie-down eyes and distribute the tension evenly.

Notes on driving with a roof load

- Distribute the roof load and vehicle load evenly, and place heavy objects at the bottom. Also observe the notes on loading the vehicle.
- Drive carefully, avoiding abrupt starting, braking and steering as well as fast cornering.

- When carrying a roof load or when the vehicle is fully loaded or occupied, select drive program **[E]** or **[C]**. These are configured for good stability (→ page 192).
- ① Further information about stowage compartments and stowage facilities can be found in the Digital Operator's Manual.

Stowage spaces in the vehicle interior

Overview of the front storage compartments

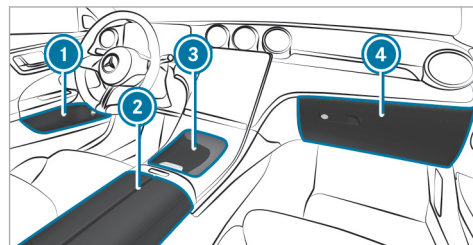

- ① Storage spaces in the doors
- ② Storage compartment under the armrest with multimedia and USB ports
- ③ Storage compartment in the front center console with cup holders, USB ports and charging module for wireless charging of mobile phones
- ④ Glove box

- ① The rubber mat in the storage compartment in front center console ③ can be removed for cleaning with clean, lukewarm water. Observe the notes on caring for the interior (→ page 377).

Opening and closing the storage compartment in the front center console

⚠ WARNING Risk of injury due to objects being stowed incorrectly

If objects in the vehicle interior are stowed incorrectly, they can slide or be thrown around and hit vehicle occupants. In addition, cup holders, open storage spaces and mobile phone brackets cannot always retain all objects they contain.

There is a risk of injury, particularly in the event of sudden braking or a sudden change in direction.

- ▶ Always stow objects in such a way that they cannot be thrown around in such situations.

- ▶ Always make sure that objects do not protrude from storage spaces, parcel nets or storage nets.
- ▶ Close the lockable storage spaces before starting a journey.
- ▶ Always stow and secure heavy, hard, pointed, sharp-edged, fragile or bulky objects in the trunk.

Observe the notes on loading the vehicle.

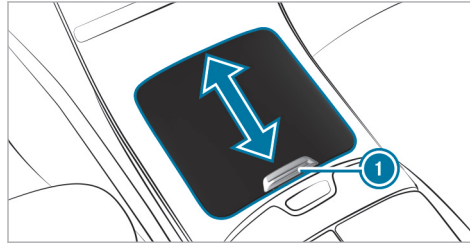

- ▶ **To open:** slide the cover of the storage compartment in the front center console all the

way forwards in the direction of the arrow using handle ①.

- ▶ **To close:** briefly push handle ① of the open cover of the storage compartment in the front center console forwards. The cover will automatically close the storage compartment in the front center console.

Opening and closing the storage compartment in the front armrest

⚠ WARNING Risk of injury due to objects being stowed incorrectly

If objects in the vehicle interior are stowed incorrectly, they can slide or be thrown around and hit vehicle occupants. In addition, cup holders, open storage spaces and mobile phone brackets cannot always retain all objects they contain.

There is a risk of injury, particularly in the event of sudden braking or a sudden change in direction.

- ▶ Always stow objects in such a way that they cannot be thrown around in such situations.
- ▶ Always make sure that objects do not protrude from storage spaces, parcel nets or storage nets.
- ▶ Close the lockable storage spaces before starting a journey.
- ▶ Always stow and secure heavy, hard, pointed, sharp-edged, fragile or bulky objects in the trunk.

Observe the notes on loading the vehicle.

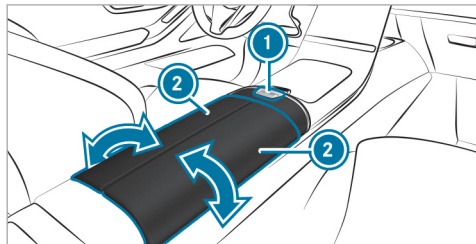

- ▶ **To open:** press release catch ① downwards. The covers of the storage compartment in front armrest ② will open automatically in the direction of the arrow.
- ▶ **To close:** move the covers of the storage compartment in front armrest ② inwards in the direction of the arrow. The storage compartment in the front armrest is now closed.

Locking/unlocking the glove box

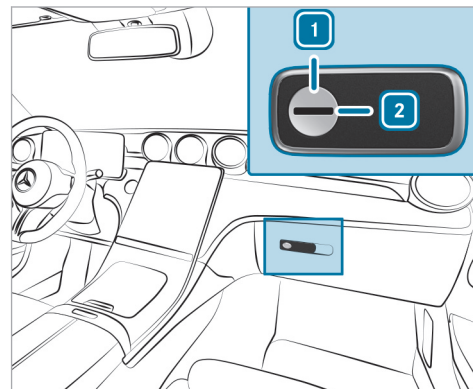

- ▶ Turn the emergency key a quarter turn clockwise ② (to lock) or counter-clockwise ① (to unlock).

Through-loading feature in the rear bench seat (EASY-PACK Quickfold)

Folding the rear seat backrests forward

⚠ WARNING Risk of becoming trapped when adjusting the seats

When you adjust a seat, you may trap yourself or a vehicle occupant.

- ▶ When adjusting a seat, make sure that no one has any body parts in the sweep of the seat.

⚠ WARNING Risk of an accident because the seat backrest is not engaged

The seat backrest may fold forwards.

There is a risk of the following, in particular:

- The vehicle occupant may be pressed against the seat belt. The seat belt cannot protect as intended and could cause additional injury.

- A child restraint system is no longer properly supported or properly positioned and may no longer fulfill its function as intended.
- The seat backrest cannot restrain objects or goods in the trunk or cargo compartment.

Always ensure that the seat backrest is engaged, especially:

- After the seat has been adjusted.
- After the cargo compartment enlargement has been folded forwards

Make sure that the red marking of the lock verification indicator is no longer visible. Otherwise, the seat backrest is not locked.

Always ensure that all vehicle occupants have their seat belts fastened correctly and are sitting properly. Particular attention must be paid to children.

Requirements

- The rear seat backrest head restraints are fully inserted.
- The rear armrest has been folded up.

Folding the rear outer seat backrests forward

You can fold the center and right seat backrests forwards separately.

The left seat backrest can be folded forwards only together with the center seat backrest.

If you no longer require the folded-down rear seat backrest as a load area, fold the backrest back into place.

- ▶ Ensure that the center seat backrest is in an upright position and locked to the left seat backrest (→ page 128).

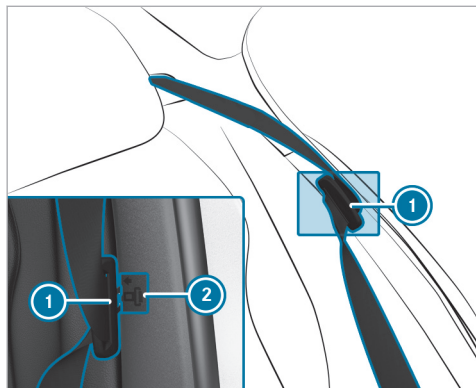

- ▶ Press the seat belt tongue of seat belt ① into marked position ②.
- ▶ Move the driver's or front passenger seat forwards, if necessary.

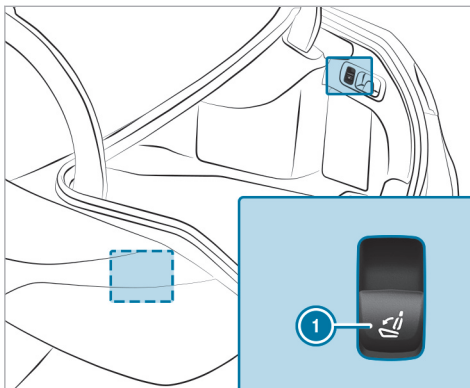

- ▶ **To fold down the left seat backrest:** pull briefly on left-hand button ①. The left seat backrest folds forward together with the center seat backrest. If the left seat backrest is not locked with the center seat backrest, this will be shown on the central display.

- ▶ **To fold down the right seat backrest:** pull briefly on right-hand button ①. The right-hand seat backrest folds forwards.

- ⓘ If you wish to fold only one of the outer seat backrests forwards, fold the right seat backrest forwards.

Folding the center rear seat backrest forwards separately

If you no longer require the folded-down seat backrest as a loading area, fold the seat backrest back into place.

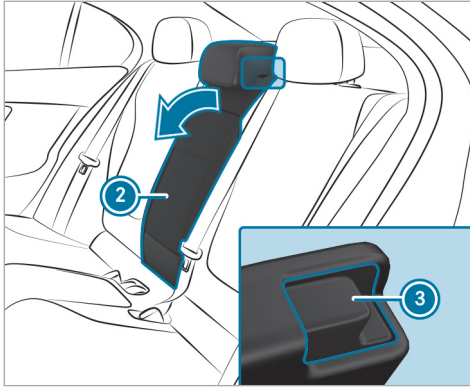

- ▶ Press release catch ③.
- ▶ Fold seat backrest ② forwards.

Folding the rear seat backrest back

! **NOTE** Damage caused by trapping the seat belt when folding back the seat backrest

The seat belt could become trapped and thus damaged when the seat backrest is folded back.

- ▶ Make sure that the seat belt is not trapped when folding back the seat backrest.

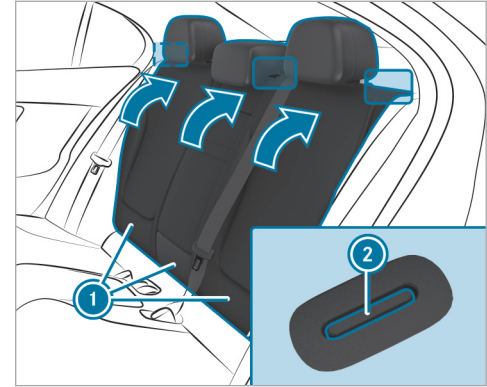

- ▶ Move the driver's or front passenger seat forwards, if necessary.
- ▶ Swivel seat backrest ① back until it engages. If the seat backrest is not engaged and locked in place, red lock verification indicator ② will be visible.

Locking and releasing the release catch of the center rear seat backrest

You can lock the center seat backrest release catch if you want to secure the trunk against unauthorized access. The center seat backrest can then be folded forwards only together with the left seat backrest.

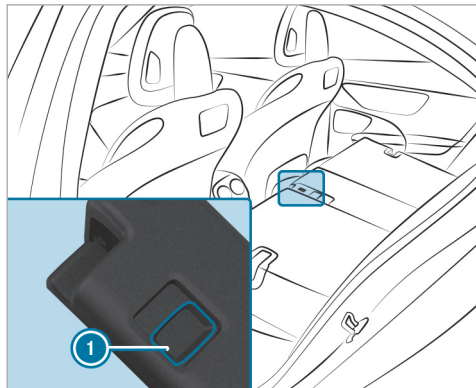

▶ **To lock or unlock:** slide catch ① upwards or downwards.

Overview of the tie-down eyes

Observe the notes on loading the vehicle (→ page 119).

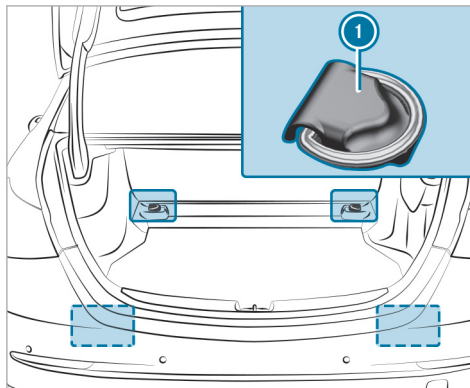

- ① Tie-down eyes
- i Four tie-down eyes are available only in vehicles equipped with the through-loading feature in the rear bench seat (EASY-PACK Quickfold).

Overview of bag hooks

⚠ WARNING Risk of injury when using bag hooks with heavy objects

The bag hooks cannot restrain heavy objects or items of luggage.

Objects or items of luggage may be flung around and hit vehicle occupants.

- ▶ Only hang light objects on the bag hooks.
- ▶ Never hang hard, sharp-edged or fragile objects on the bag hooks.

Observe the notes on loading the vehicle (→ page 119).

The bag hook can bear a maximum load of 6.6 lbs (3 kg). Do not use it to secure a load.

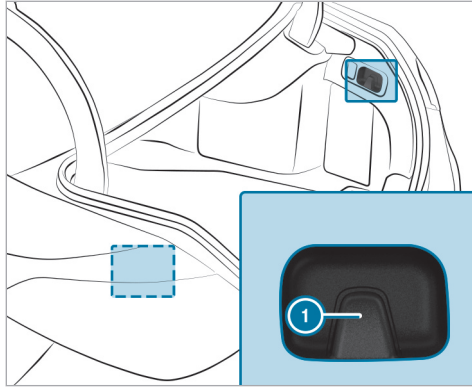

1 Bag hook

Attaching a roof luggage rack

⚠ WARNING Risk of accident due to exceeding the maximum roof load

The vehicle center of gravity and the usual driving characteristics as well as the steering and braking characteristics alter.

If you exceed the maximum roof load, the driving characteristics, as well as steering and braking, will be greatly impaired.

- ▶ Never exceed the maximum roof load and adjust your driving style.

Vehicle-specific weight information can be found on the vehicle identification plate.

! NOTE Vehicle damage due to failure to observe the maximum permissible clearance height

If the vehicle height exceeds the maximum permissible clearance height, the roof and other vehicle parts may be damaged.

- ▶ Please observe the maximum clearance height indicated.
- ▶ If the vehicle exceeds the permissible clearance height, do not drive in.
- ▶ Take the modified vehicle height into account in the case of roof superstructures or other carrier systems.

! NOTE Vehicle damage from non-approved roof luggage racks

The vehicle could be damaged by roof luggage racks that have not been tested and approved for Mercedes-Benz.

- ▶ Use only roof luggage racks tested and approved for Mercedes-Benz.
- ▶ Depending on the vehicle equipment, ensure that the sliding sunroof can be fully raised when the roof luggage rack is installed.
- ▶ Depending on the vehicle equipment, ensure that the trunk lid can be fully

opened when the roof luggage rack is installed.

- ▶ Position the load on the roof luggage rack in such a way that the vehicle will not sustain damage even when it is in motion.

! **NOTE** Damage to the panorama roof with power tilt/sliding panel due to non-approved roof luggage racks

The panorama roof with power tilt/sliding panel may be damaged by the roof luggage rack if you attempt to open it when using a roof luggage rack not tested and approved for Mercedes-Benz.

- ▶ When a roof luggage rack is installed, open the panorama roof with power tilt/sliding panel only if this has been tested and approved for Mercedes-Benz.

The panorama roof with power tilt/sliding panel may be raised to allow ventilation of the vehicle interior.

! **NOTE** Damage to the sliding sunroof when a roof luggage rack is installed

If the sliding sunroof is opened when a roof luggage rack is installed, the sliding sunroof may be damaged by the roof luggage rack.

- ▶ Do not open the sliding sunroof if a roof luggage rack is installed.

The sliding sunroof may be raised to allow ventilation of the vehicle interior.

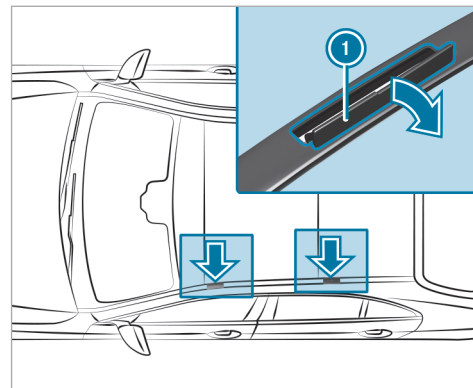

! **NOTE** Damage to the covers

The covers may be damaged and scratched when being opened.

- ▶ Do not use metallic or hard objects.

- ▶ Fold covers ① carefully upwards in the direction of the arrow.

- ▶ Secure the roof luggage rack to the fastening points beneath covers ①.
- ▶ Comply with the installation instructions of the roof luggage rack manufacturer.
- ▶ Secure the load on the roof luggage rack.

Cup holder

Installing the cup holder in or removing it from the center console

⚠ WARNING - Risk of accident or injury when using the cup holder while the vehicle is moving

The cup holder cannot secure containers while the vehicle is moving.

If you use a cup holder while the vehicle is moving, the container may be flung around and liquids may be spilled. The vehicle occupants may come into contact with the liquid and if it is hot, they could be scalded. You could be distracted from traffic conditions and you may lose control of the vehicle.

- ▶ Only use the cup holder when the vehicle is stationary.
- ▶ Only use the cup holder for containers of the right size.
- ▶ Close the container, particularly if the liquid is hot.

⚠ WARNING Risk of injury due to objects being stowed incorrectly

If objects in the vehicle interior are stowed incorrectly, they can slide or be thrown around and hit vehicle occupants. In addition, cup holders, open storage spaces and mobile phone brackets cannot always retain all objects they contain.

There is a risk of injury, particularly in the event of sudden braking or a sudden change in direction.

- ▶ Always stow objects in such a way that they cannot be thrown around in such situations.

- ▶ Always make sure that objects do not protrude from storage spaces, parcel nets or storage nets.
- ▶ Close the lockable storage spaces before starting a journey.
- ▶ Always stow and secure heavy, hard, pointed, sharp-edged, fragile or bulky objects in the trunk.

Observe the notes on loading the vehicle.

Removing the wing of the cup holder

The wing of the cup holder can be removed to stow smaller items in the cup holder.

- ① The installation and removal as well as the operation of the wing of the cup holder are shown using the example of a cup holder with double wing.

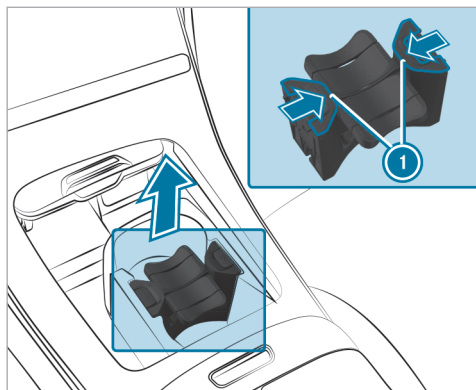

- ▶ Push snap-in brackets **1** of the wing inwards in the direction of the arrow until they release.
- ▶ Pull the wing of the cup holder upwards and out of the storage compartment.

Installing the wing of the cup holder

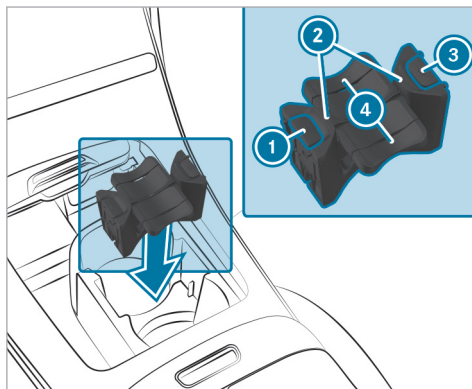

- ▶ If necessary, open the cover of the storage compartment in the front center console.
- ▶ Place the wings of the cup holder onto the bar in the storage compartment as shown.
- ▶ Slide snap-in brackets **2** outwards until they engage.

Operating the wings of the cup holder

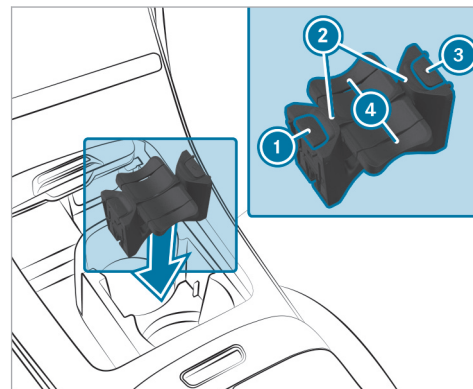

- ▶ Press button **1** and/or **3**.
Wings **4** of the cup holder will fold upwards.

The wings of the cup holder can be folded down until the wings engage and remain in the folded position. The cup holder's holding function will then not be available.

- i** When you are using the cup holder for different containers, the wings of the cup holder automatically adjust to the diameter of the container.

Installing the cup holder housing

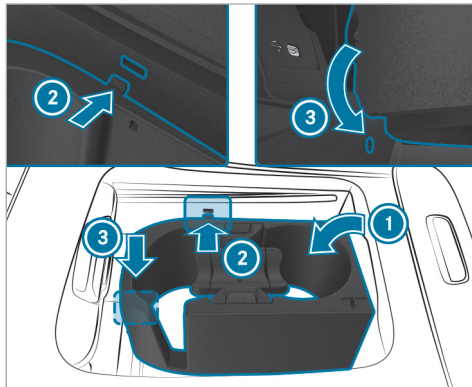

- ▶ Insert cup holder housing **1** into the storage compartment in the front center console at a slight angle.

- ▶ Engage hook **2** in the side opening in the storage compartment.
- ▶ Press the front part of housing **3** downwards until it engages.

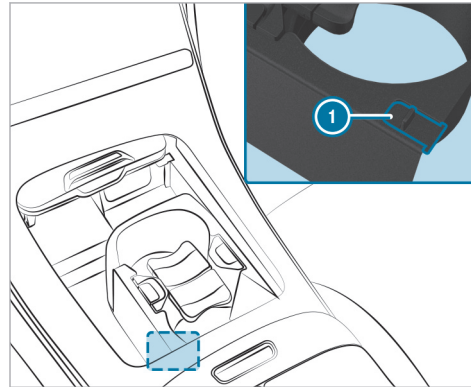

- ▶ Then push catch **1** on the cup holder housing backwards. The cup holder housing is locked.

Removing the cup holder housing

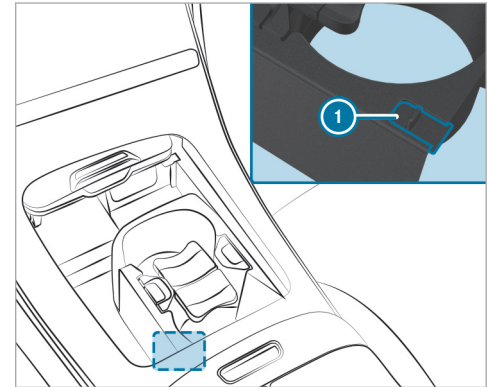

- ▶ Push catch **1** on the cup holder housing forwards. The cup holder housing is released.

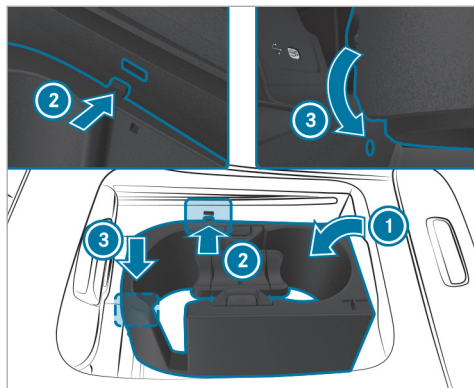

- ▶ Pull the front part of housing ③ upwards with a slight jerk.
- ▶ Disengage hook ② from the side opening in the storage compartment of the front center console.
- ▶ Remove cup holder housing ① from the storage compartment of the front center console at a slight angle.

- ① The cup holder and the rubber mat underneath it can be removed for cleaning, e.g. with clean, lukewarm water.

Ashtray and cigarette lighter

Using the ashtray

! **NOTE** Damage to the stowage compartment under the ashtray due to intense heat

The stowage compartment under the ashtray is not heat resistant and could be damaged if you rest a lit cigarette on it.

- ▶ Make sure that the ashtray is fully engaged.

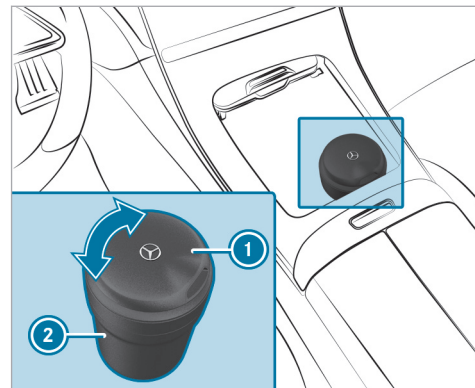

- ▶ Place ashtray ② in one of the cup holders in the center console or in the rear passenger compartment.
- ▶ Check that it is seated firmly.
- ▶ Comply with the notes on loading the vehicle (→ page 119).
- ▶ **To open the ashtray:** fold lid ① upwards.
- ▶ **To close the ashtray:** press lid ① down.

- ① You can remove the top part of the ashtray for cleaning or emptying by twisting it. Clean the ashtray, e.g. with clean, lukewarm water.

Sockets

Using the 12 V socket

Requirements

- Connect only devices up to a maximum of 180 W (15 A).

Depending on the vehicle equipment, the vehicle has the following 12 V sockets:

- In the front passenger footwell
- In the electronics compartment in the center console of the rear passenger compartment

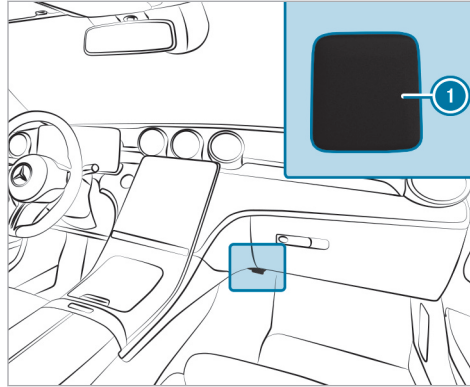

Example: 12 V socket in the front passenger footwell

- ▶ Fold up the cap of socket ①.
- ▶ Insert the plug of the device.

Using the 115 V socket in the rear passenger compartment

⚠ DANGER Risk of fatal injuries due to a damaged connecting cable or a damaged socket

You could receive an electric shock if the connecting cable or the 115 V power socket is pulled out of the trim or is damaged or wet.

- ▶ Use only connecting cables that are dry and free of damage.
- ▶ When the vehicle is switched off, make sure that the 115 V power socket is dry.
- ▶ Immediately have the 115 V power socket checked or replaced at a qualified specialized workshop if it is damaged or has been pulled out of the trim.
- ▶ Never plug the connecting cable into a 115 V power socket that is damaged or has been pulled out of the trim.

⚠ DANGER Risk of death due to using the socket incorrectly

In particular, you could receive an electric shock:

- If you touch the inside of the socket
- If you insert unsuitable devices or objects into the socket

- ▶ Do not touch the inside of the socket.
- ▶ Only connect suitable devices to the socket.

Make sure that no liquids get into the 115 V socket.

When the 115 V socket is not in use, keep the socket flap closed.

Requirements

- Only connect devices with a suitable plug which conforms to the standards specific to the country you are in.
- Only connect devices up to a maximum of 150 W.
- Do not use multiple socket outlets.

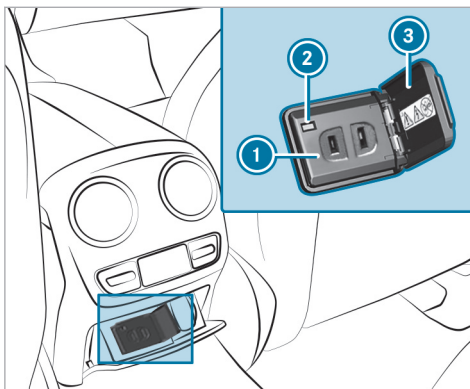

- ▶ Open socket flap ③.
 - ▶ Insert the plug of the device into 115 V socket ①.
- When the on-board electrical system voltage is sufficient, indicator lamp ② lights up.

USB ports

Depending on its equipment, the vehicle has the following USB ports:

- In the storage compartment in the front center console
- In the storage compartment under the front armrest
- In the electronics compartment in the center console of the rear passenger compartment

Depending on the vehicle equipment, the vehicle has either one or two USB ports in the storage compartment in the front center console and beneath the front armrest.

Depending on the vehicle equipment, the vehicle has two USB ports in the rear passenger compartment center console.

When the vehicle is switched on, you can charge a USB device ① (e.g. mobile phone) at USB ports using a suitable charging cable. Depending on the vehicle equipment, the USB device can be charged with up to 20 V (5 A).

Wireless charging of the mobile phone and connection with the exterior antenna

Notes on wirelessly charging a mobile phone

⚠ WARNING Risk of injury due to objects being stowed incorrectly

If objects in the vehicle interior are stowed incorrectly, they can slide or be thrown around and hit vehicle occupants. In addition, cup holders, open stowage spaces and mobile phone receptacles cannot always retain all objects within.

There is a risk of injury, particularly in the event of sudden braking or a sudden change in direction.

- ▶ Always stow objects so that they cannot be thrown around in such situations.
- ▶ Always make sure that objects do not protrude from stowage spaces, parcel nets or stowage nets.
- ▶ Close the lockable stowage spaces before starting a journey.

- ▶ Always stow and secure heavy, hard, pointed, sharp-edged, fragile or bulky objects in the trunk/cargo compartment.

Observe the notes on loading the vehicle.

⚠ WARNING Risk of fire from placing objects in the mobile phone storage compartment

Placing other objects in the mobile phone storage compartment could constitute a fire hazard.

- ▶ Apart from a mobile phone, do not place any other objects in the mobile phone storage compartment, especially those made of metal.

! NOTE Damage to objects caused by placing them in the mobile phone storage compartment

If objects are placed in the mobile phone storage compartment, these may be damaged by electromagnetic fields.

- ▶ Do not place credit cards, storage media, ski passes or other objects sensitive to electromagnetic fields in the mobile phone storage compartment.

! NOTE Damage to the mobile phone stowage compartment caused by liquids

If liquids enter the mobile phone stowage compartment, the compartment may be damaged.

- ▶ Ensure that no liquids enter the mobile phone stowage compartment.

Always observe the notes for persons with electronic medical aids (→ page 32).

- Depending on the vehicle equipment, the mobile phone is connected to the vehicle's exterior antenna via the charging module.
- The charging function and wireless connection of the mobile phone to the vehicle's exterior antenna are available only if the vehicle is switched on.

- Small mobile phones may not be able to be charged in every position of the mobile phone stowage compartment.
- Large mobile phones that do not rest flat in the mobile phone stowage compartment may not be able to be charged or connected with the vehicle's exterior antenna.
- The mobile phone may heat up during the charging process. This may also depend on the applications (apps) currently open in the background.
- To ensure more efficient charging and connection with the vehicle's exterior antenna, remove the protective cover from the mobile phone. Protective covers that are necessary for wireless charging are an exception.

Wirelessly charging a mobile phone in the front

Requirements

- The mobile phone is suitable for wireless charging.

A list of compatible mobile phones can be found at: <https://www.mercedes-benz-mobile.com/>

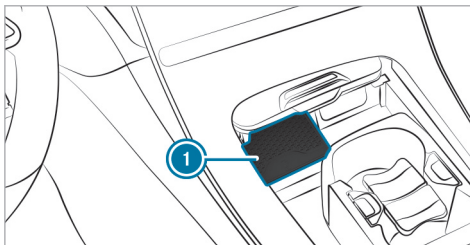

Wirelessly charging a mobile phone in the front storage compartment

- ▶ Place the mobile phone in the front storage compartment as centrally as possible with the display facing upwards on mat ① next to the USB ports.

When the charging symbol is shown on the driver's display, the mobile phone is being charged. In addition, malfunctions when the mobile phone is being charged are shown on the central display.

- ① The mat can be removed for cleaning, e.g. using clean, lukewarm water.

Installing/removing the floor mats

⚠ WARNING Risk of accident due to objects in the driver's footwell

Objects in the driver's footwell may impede pedal travel or block a depressed pedal.

This will jeopardize the operating- and road safety of the vehicle.

- ▶ Stow all objects in the vehicle securely so that they cannot get into the driver's footwell.
- ▶ Make sure that there is always sufficient clearance for the pedals.
- ▶ Always install the floor mats securely and as prescribed.
- ▶ Do not use loose floor mats and do not place floor mats on top of one another.

Installing floor mats

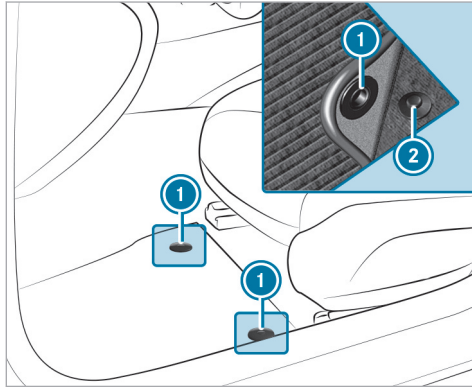

- ▶ Slide the corresponding seat backwards and lay the floor mat in the footwell.
- ▶ Press studs ① onto holders ②.
- ▶ Adjust the corresponding seat.

Removing floor mats

- ▶ Slide the corresponding seat backwards.

- ▶ Pull the floor mat off holders ②.
- ▶ Remove the floor mat.

Inserting or removing floor mats on the second seat row

- ▶ **To insert:** push the corresponding seat on the first seat row forwards and lay the floor mat in the rear passenger compartment footwell such that it fits neatly.
- ▶ **To remove:** push the corresponding seat on the first seat row forwards and remove the floor mat from the rear passenger compartment footwell.

Exterior lighting

Information about lighting systems and your responsibility

The various lighting systems of the vehicle are only aids. The driver of the vehicle is responsible for correct vehicle illumination in accordance with the prevailing light and visibility conditions, legal requirements and traffic situation.

Light switch

Operating the light switch

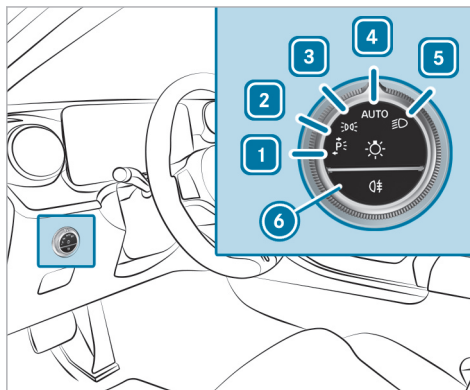

- 1 Left-hand parking lights
- 2 Right-hand parking lights
- 3 Standing lights and license plate lamp
- 4 **AUTO** Automatic driving lights (preferred light switch position)

- 5 Low beam/high beam
- 6 Activates or deactivates the rear fog light.

When low beam is activated, the indicator lamp for the standing lights will be deactivated and replaced by the low-beam indicator lamp.

▶ Always park your vehicle safely using sufficient lighting, in accordance with the relevant legal stipulations.

! **NOTE** Battery discharging by operating the parking lamps

Do not have the parking lamps switched on over a period of several hours.

If the battery is insufficiently charged, the standing lights or parking lights will be switched off automatically to facilitate the next engine start.

The exterior lighting (except standing and parking lights) will switch off automatically when the driver's door is opened.

- Observe the notes on locator lighting (→ page 150).

Switching on accident scene lighting

- ▶ Switch off the vehicle.
- ▶ Switch on the hazard warning lamps (→ page 142).
- ▶ Turn the light switch from the **AUTO** position to the  position. The low beam will be switched on despite the vehicle being switched off.

The accident scene lighting will be switched off if:

- you switch off the hazard warning lights.
- you turn the light switch back to **AUTO**.
- the battery is insufficiently charged.

Automatic driving lights function

When the vehicle is switched on, the standing lights, low beam and daytime running lights will be

switched on automatically depending on the ambient light.

⚠ WARNING Risk of accident when the low beam is switched off in poor visibility



When the light switch is set to **AUTO**, the low beam may not be switched on automatically if there is fog, snow or other causes of poor visibility such as spray.

- ▶ In such cases, turn the light switch to .

The automatic driving lights are only an aid. You are responsible for the vehicle lighting.

Switching the rear fog light on/off

Requirements

- The light switch is in the  or **AUTO** position.
- ▶ Press button .

Please observe the country-specific laws on the use of rear fog lamps.

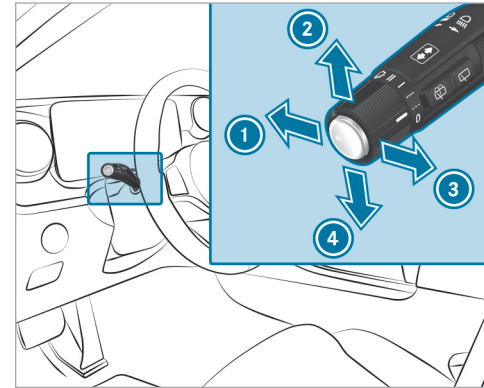

Operating the combination switch for the lights



- 1 High beam
- 2 Turn signal light, right
- 3 Headlamp flashing
- 4 Turn signal light, left

- ▶ Use the combination switch to select the desired function.

Switching on high beam

- ▶ Turn the light switch to the  or **AUTO** position.
- ▶ Push the combination switch in the direction of arrow ①.
When high beam is activated, the indicator lamp for low beam  will be deactivated and replaced by the indicator lamp for high beam .

Switching off high beam

- ▶ Push the combination switch in the direction of arrow ① or pull it in the direction of arrow ③.

Headlamp flashing

- ▶ Pull the combination switch in the direction of arrow ③.

Turn signal lights

- ▶ **To indicate briefly:** push the combination switch briefly to the point of resistance in the direction of arrow ② or ④.
The corresponding turn signal light will flash three times.
- ▶ **To indicate permanently:** push the combination switch beyond the point of resistance in the direction of arrow ② or ④.

Vehicles with Active Lane Change Assist:

- A turn signal indicator activated by the driver may continue to operate for the duration of the lane change.
- If the driver indicated directly beforehand but a lane change was not immediately possible, the turn signal indicator may activate automatically.

Activating/deactivating the hazard warning lights

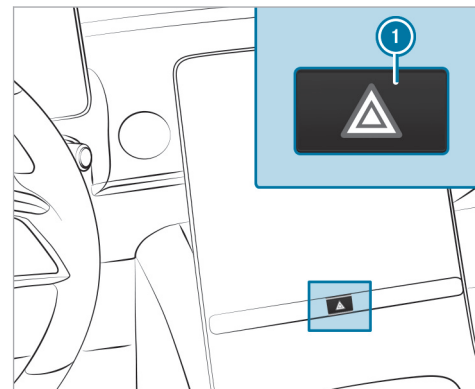

- ▶ Press button ①.

The hazard warning lights will switch on automatically if:

- the air bag has been deployed.

DIGITAL LIGHT adaptive functions

Function of dynamic low beam

With this system, the headlamps adapt to the driving and weather situation. It also provides extended functions for improved illumination of the road.

i The availability of the functions is country-dependent.

The system comprises the following functions:

- Active Headlamps (→ page 143)
- Cornering Light (→ page 143)
- Highway mode (→ page 144)
- Enhanced fog light function (→ page 144)
- Bad weather light (→ page 144)
- City lighting (→ page 144)
- Topographical compensation (→ page 144)

The system will be active only when it is dark.

Active headlamps function

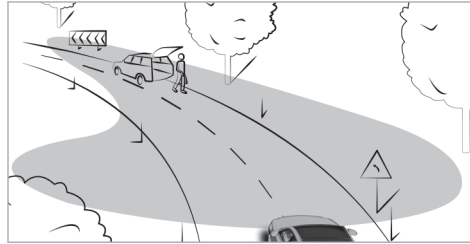

- The headlamps will follow your steering movements.
- Relevant areas will be better illuminated during a journey.

The functions will be active when the low beam is switched on.

Depending on the vehicle's equipment, the course of the lane in which you are driving will also be evaluated and the active headlamps function will adjust the light in advance.

Cornering light function

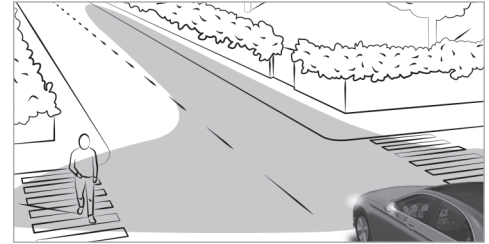

The cornering light improves the illumination of the road over a wide angle in the turning direction, enabling better visibility on tight bends, for example. The cornering light will be activated only when low beam is switched on.

The function will be active in the following cases:

- At speeds below 25 mph (40 km/h) when the turn signal light is switched on or the steering wheel is turned
- At speeds between 25 mph (40 km/h) and 43 mph (70 km/h) and when the steering wheel is turned

Traffic circle and intersection function (Canada):

the cornering light will be activated on both sides based on an evaluation of the vehicle's current navigation position. It will remain active until after the vehicle has left the traffic circle or intersection.

Highway mode function (Canada)

Highway mode increases the range and brightness of the cone of light, enabling better visibility.

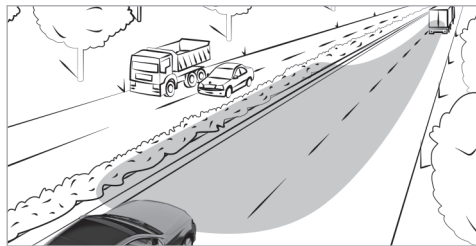

The function will be active if a highway journey is detected by means of:

- the vehicle's speed
- the multifunction camera

- the navigation system

The function will not be active in the following cases:

- At speeds below 50 mph (80 km/h)

Enhanced fog light function (Canada)

The enhanced fog light function reduces self-dazzling and improves the illumination of the edge of the carriageway.

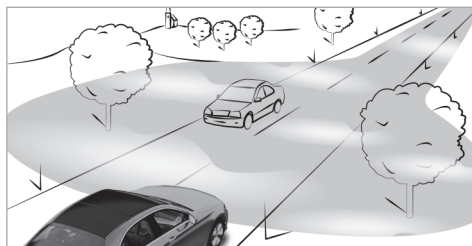

The function is automatically activated under the following conditions:

- At speeds below 43 mph (70 km/h) and when the rear fog light is switched on.

The function is automatically deactivated under the following conditions:

- When speeds greater than 62 mph (100 km/h) are reached.
- When the rear fog light is switched off.

Function of the bad weather light (Canada)

The bad weather light reduces reflections in rainy conditions by dimming individual areas of the headlamps. There will be less glare for the driver and other road users as a result.

The city lighting function (Canada)

City lighting improves the illumination of roadsides in urban areas using a broad distribution of light.

The function will be active in the following cases:

- At low speeds
- In illuminated parts of urban areas

Function of the topographical compensation

Based on available map data, the lighting system responds pre-emptively to different road heights. This means that the headlamp range will remain

virtually constant when you are driving uphill or downhill.

- ❗ Only vehicles with a multimedia system with navigation have this function.

Assistance functions of DIGITAL LIGHT

DIGITAL LIGHT visually expands on the driver assistance systems by projecting the assistant displays in front of the vehicle while it is in motion. DIGITAL LIGHT can therefore help the driver in critical situations.

- ❗ The availability of the functions is country-dependent.
- ❗ The assistance functions of DIGITAL LIGHT may be an on-demand feature (→ page 24).

The system will remain active when Highbeam Assist is switched on.

- ❗ Depending on the country in which you are currently driving, certain functions may be disabled due to different legal requirements, even if they are enabled in the multimedia system. When you cross a border, the vehicle will automatically adapt to the applicable requirements.

Spotlight

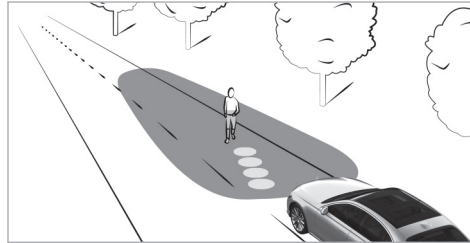

The spotlight function runs in the background and will flash the headlamps in four short bursts at persons detected within the lane markings. You will also be made aware of the position of the person by a projected symbol.

The function will be active in the following circumstances:

- You are driving in an unlit area.
- The system detects a lane marking.

Notes

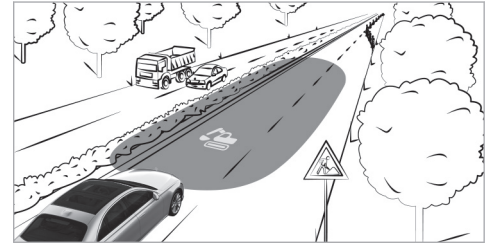

If Traffic Sign Assist detects a roadworks zone, the system will provide support as follows:

- A corresponding symbol will be projected onto the road when you enter a roadworks zone.

Observe the system limitations of Traffic Sign Assist (→ page 260).

Collision warning

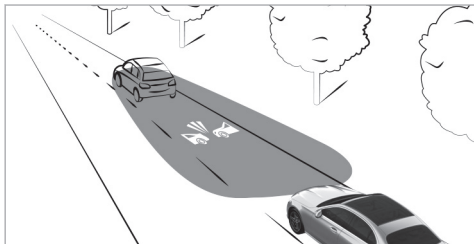

If you fall below the safe distance at speeds of at least 19 mph (30 km/h), a collision warning symbol will be projected onto the road.

Observe the system limitations of Active Brake Assist (→ page 255).

Lane change warning

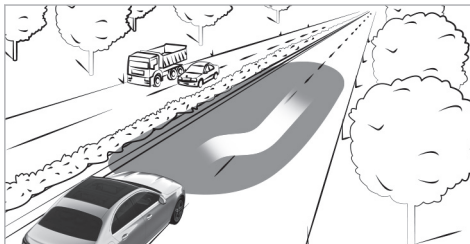

During assisted lane changes at speeds of at least 19 mph (30 km/h), the course of the lane change will flash.

Observe the system limitations of Active Lane Change Assist (→ page 250).

Lane keeping and blind spot warning



At speeds of at least 19 mph (30 km/h), a triangle that indicates a lane correction and its direction will be projected onto the road in the following cases:

- You leave the lane unintentionally.
Observe the system limitations of Active Lane Keeping Assist (→ page 268).
- You switch on the turn signal light while an object or obstacle is in your blind spot.
Observe the system limitations of Active Blind Spot Assist (→ page 264).

Adaptive Highbeam Assist

Adaptive Highbeam Assist function

⚠ WARNING Risk of accident despite Adaptive Highbeam Assist

Adaptive Highbeam Assist does not react to:

- Road users without lights, e.g. pedestrians
- Road users with poor lighting, e.g. cyclists
- Road users whose lighting is obstructed, e.g. by a barrier

On very rare occasions, Adaptive Highbeam Assist may fail to recognize other road users with their own lighting, or may recognize them too late.

In these, or in similar situations, the automatic high beam will not be deactivated or will be activated despite the presence of other road users.

▶ Always observe the road and traffic conditions carefully and switch off the high beam in good time.

Adaptive Highbeam Assist cannot take into account road, weather or traffic conditions.

Detection may be restricted in the following cases:

- In poor visibility, e.g. fog, heavy rain or snow
- if there is dirt on the sensors or the sensors are obscured

Adaptive Highbeam Assist is only an aid. You are responsible for adjusting the vehicle's lighting to the prevailing light, visibility and traffic conditions.

i Adaptive Highbeam Assist is available on demand (→ page 24).

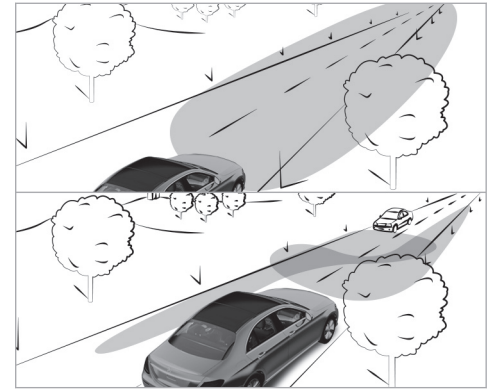

Adaptive Highbeam Assist automatically switches between the following types of light:

- Low-beam headlamps
- High beam

At speeds greater than 19 mph (30 km/h):

- If no other road users are detected, high beam will switch on automatically.

High beam will switch off automatically in the following cases:

- At speeds below 16 mph (25 km/h)
 - If other road users are detected
 - If street lighting is sufficient
-  The system's optical sensor is located behind the windshield near the overhead control panel.

Switching Adaptive Highbeam Assist on/off

Switching on

- ▶ Turn the light switch to the **AUTO** position.
- ▶ Switch on high beam using the combination switch.
If Adaptive Highbeam Assist is activated, the  indicator lamp will light up on the driver's display.

Switching off

- ▶ Switch off high beam using the combination switch.

Adaptive Highbeam Assist Plus

Adaptive Highbeam Assist Plus function (Canada)

 **WARNING** Risk of accident despite Adaptive Highbeam Assist Plus

Adaptive Highbeam Assist Plus does not react to:

- Road users without lights, e.g. pedestrians
- Road users with poor lighting, e.g. cyclists
- Road users whose lighting is obstructed, e.g. by a barrier

On very rare occasions, Adaptive Highbeam Assist Plus may fail to recognize other road users with their own lighting, or may recognize them too late.

In these, or in similar situations, the automatic high beam will not be deactivated or will be activated despite the presence of other road users.

- ▶ Always observe the road and traffic conditions carefully and switch off the high beam in good time.

Adaptive Highbeam Assist Plus cannot take into account road, weather or traffic conditions.

Detection may be restricted in the following cases:

- in poor visibility, e.g. fog, heavy rain or snow
- if there is soiling on the sensors or the sensors are obscured

Adaptive Highbeam Assist Plus is only an aid. You are responsible for adjusting the vehicle's lighting to the prevailing light, visibility and traffic conditions.

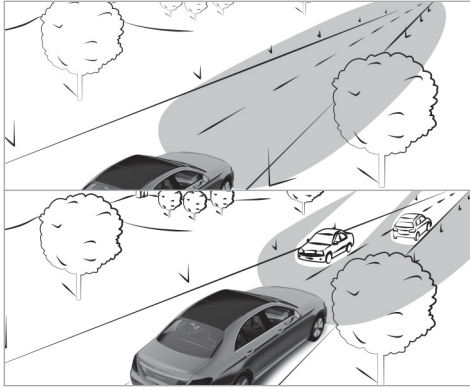

Adaptive Highbeam Assist Plus automatically switches between the following types of light:

- Low beam
- Partial high beam
- High beam
- ULTRA RANGE Highbeam

ULTRA RANGE Highbeam increases the brightness of the cone of light close to the legally permitted maximum.

Partial high beam does not include other road users in the high beam area. It does not dazzle them but enables full high-beam illumination for the driver apart from the excluded vehicles. Highly reflective signs are also illuminated with reduced brightness.

At speeds below 16 mph (25 km/h) or when there is sufficient street lighting:

- Partial high beam and high beam will be switched off automatically.

At speeds above 19 mph (30 km/h):

- If no other road users are detected, the high beam will be switched on automatically.
- If other road users are detected, partial high beam will be switched on automatically.

at speeds below 25 mph (40 km/h):

- ULTRA RANGE Highbeam will switch off automatically.

At speeds above 31 mph (50 km/h):

- If no other road users are detected, the road is straight and it is not raining heavily, ULTRA RANGE Highbeam will be switched on automatically.
- If other road users are detected, partial high beam will be switched on automatically.
- If highly reflective signs are detected, ULTRA RANGE Highbeam will be switched off automatically.

i The system's optical sensor is located behind the windshield near the overhead control panel.

Switching Adaptive Highbeam Assist Plus on/off (Canada)

Switching on

- ▶ Turn the light switch to the **AUTO** position.
 - ▶ Switch on high beam using the combination switch.
- If Adaptive Highbeam Assist Plus is activated, the  indicator lamp will light up on the driver's display. When partial high beam or

high beam is active, the corresponding blue indicator lamp will also light up.

Switching off

- ▶ Switch off high beam using the combination switch.

Switching the daytime running lights on/off

Multimedia system:

→  ▶ Settings ▶ Light
▶ DIGITAL LIGHT

- ▶ Switch the **daytime running lights** on or off.
- ⓘ In vehicles without DIGITAL LIGHT headlamps, the daytime running lights can be switched on or off on the **driving lights** menu.
- ⓘ The availability of the function is country-dependent.

Setting the exterior lighting switch-off delay time

Multimedia system:

→  ▶ Settings ▶ Light
▶ Interior/Exterior Lighting
▶ Exterior Lighting Switch-off Delay

- ▶ Set a switch-off delay time.
When the vehicle's engine is switched off, the exterior lighting will be activated for the set time.

Activating/deactivating locator lighting

Multimedia system:

→  ▶ Settings ▶ Light
▶ Interior/Exterior Lighting



- ▶ Activate or deactivate **Locator Lighting**.

When the function is activated, the exterior lighting will light up for 40 seconds after the vehicle is unlocked or the driver's door is opened when the vehicle is parked and not locked. When you start the vehicle, the locator lighting will be deactivated and the automatic driving lights activated.

Interior lighting

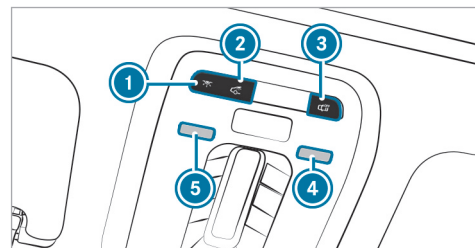
Adjusting the interior lighting



- ①  Switches the front interior lighting on/off.
- ②  Switches the rear interior lighting on/off.
- ③  Switches automatic interior lighting control on/off.

- ▶ **To switch reading lamps on/off:** hold your hand under the respective reading lamp ④ or ⑤.

Operating unit inside the grab handle (rear passenger compartment)

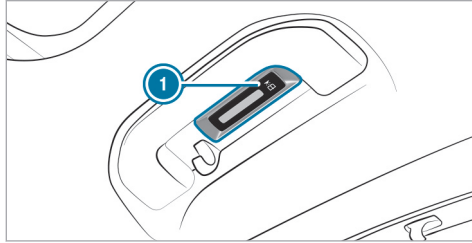

①  Rear reading lamp

▶ To switch on or off: press button ①.

Adjusting the ambient lighting

Multimedia system:

 ▶▶ Comfort ▶▶ Ambient Light

Setting the color

- ▶ Select **Color**.
- ▶ Select **Monochrome** or **Multi-color**.

- ▶ Set the desired color or color scheme.

Adjusting the brightness

- ▶ Select **Brightness**.
- ▶ Adjust the brightness.
- ① Depending on the light conditions, the ambient lighting will automatically switch between day and night modes.

Activating the brightness for zones

- ▶ Select **Brightness**.
- ▶ Switch off **Link Zones** .
The **Direct**, **Indirect** and **Accents** zones can be set separately.
- ① The **Light Band** zone can also be set in vehicles with active ambient lighting.

Activating effects

⚠ WARNING Risk of accident if ambient lighting and active ambient lighting effects are not switched on

The warning assistance effects will be fully active only when the relevant driving or driving safety systems are activated on the Driving Assistance menu.

- ▶ Make sure that the relevant driving or driving safety systems are activated.

- ① Observe the notes on driving systems and your responsibility; you may otherwise fail to recognize dangers (→ page 229).
- ▶ Select **Effects**.
- ▶ Activate the desired effect.
- ① Different effects will be available depending on the vehicle equipment.

Multi-color Animation

- The chosen color combination will change at predefined intervals.

Climate

- If changes are made to the temperature setting in the vehicle, the color of the ambient lighting will change briefly.

Warning When Exiting

- If an object is detected in the blind spot while you are getting out of the vehicle, the ambient lighting in the affected door will flash red.
Further information on the exit warning (→ page 264).

Switching the interior lighting switch-off delay time on/off

Multimedia system:

→  ► Settings ► Light

► Interior/exterior lighting

► Interior Lighting Switch-off Delay

- Activate or deactivate **Interior Lighting Switch-off Delay**.



If this function is active, the interior lighting will be switched on for a short time after the end of the journey.

Windshield wiper and windshield washer system

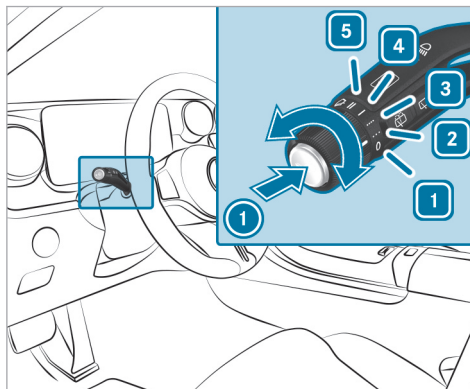
Switching the windshield wipers on or off



- | | | |
|----------|----------|----------------------------|
| 1 | 0 | Windshield wipers off |
| 2 | ... | Automatic wiping, normal |
| 3 | | Automatic wiping, frequent |
| 4 | — | Continuous wiping, slow |
| 5 | == | Continuous wiping, fast |

- Turn the combination switch to the corresponding position **1** - **5**.
-  **Single wipe:** press button **1** as far as the pressure point.
-  **Wiping with washer fluid:** press button **1** beyond the pressure point.
- ◻ **i** Observe the notes on washing the vehicle in a car wash (→ page 370).

Changing the windshield wiper blades

- ▲ **WARNING** Risk of becoming trapped if the windshield wipers are switched on while wiper blades are being replaced

If the windshield wipers begin to move while you are changing the wiper blades, you can be trapped by the wiper arm.

- Always switch off the windshield wipers and vehicle before changing the wiper blades.

Moving the wiper arms into the replacement position

- ▶ Switch the vehicle on and then off again immediately.
- ▶ Within around 15 seconds, press the  button on the combination switch for approximately three seconds (→ page 152). The wiper arms will move into the replacement position.
- ⓘ Depending on the production period of the vehicle, different variants of the wiper blades will have been installed.

Removing the wiper blades (variant 1)

- ▶ Fold the wiper arms away from the windshield.

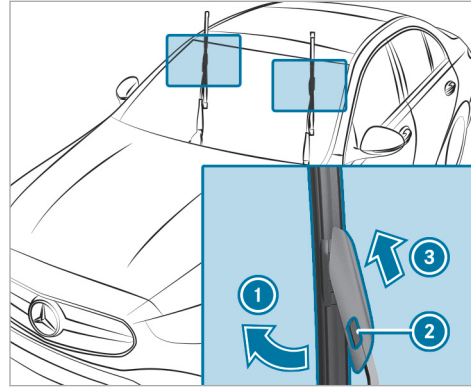

- ▶ Hold the wiper arm with one hand. With the other hand, turn the wiper blade away from the wiper arm in the direction of arrow ① as far as it will go.
- ▶ Press release knob ②.
- ▶ Remove the wiper blade in the direction of arrow ③ away from the wiper arm.

Removing the wiper blades (variant 2)

- ▶ Fold the wiper arms away from the windshield.

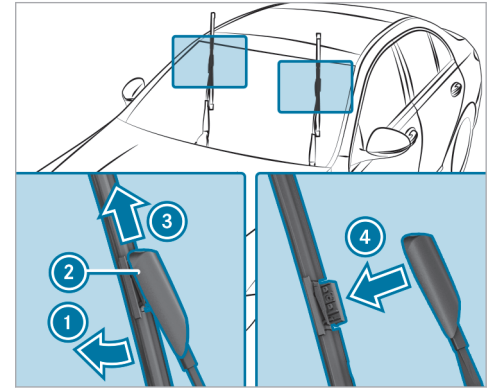

- ▶ Hold the wiper arm with one hand. With the other hand, turn the wiper blade away from the wiper arm in the direction of arrow ① as far as it will go.
- ▶ Slide catch ② in the direction of arrow ④ until it engages in the removal position.

- ▶ Remove the wiper blade from the wiper arm in the direction of arrow ④.

Installing the wiper blades (variant 1)

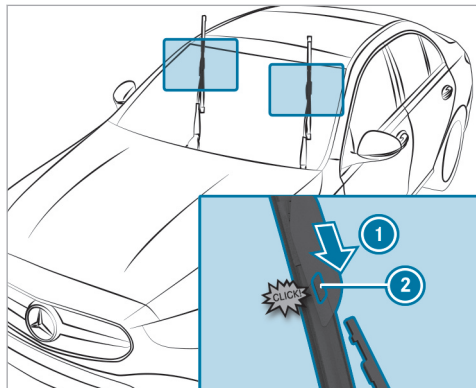

- ▶ Insert the new wiper blade in to the wiper arm in the direction of arrow ① until release knob ② engages.

- ▶ Make sure that the wiper blade is seated correctly.
- ▶ Fold the wiper arms back onto the windshield.
- ▶ Switch on the vehicle.
- ▶ Press the  button on the combination switch. The wiper arms will return to their original positions.
- ▶ Switch off the vehicle.

Installing the wiper blades (variant 2)

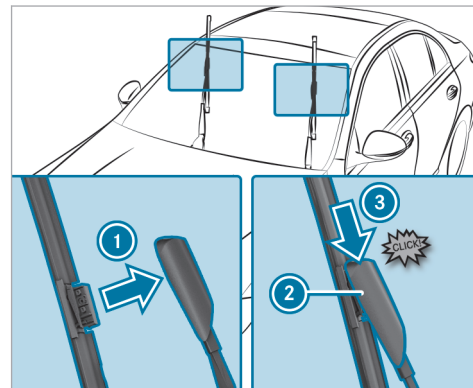



- ▶ Insert the new wiper blade into the wiper arm in the direction of arrow ①.
- ▶ Slide catch ② in the direction of arrow ③ until it engages in the locking position.
- ▶ Make sure that the wiper blade is seated correctly.
- ▶ Fold the wiper arms back onto the windshield.

- ▶ Switch on the vehicle.
- ▶ Press the  button on the combination switch.
The wiper arms will return to their original positions.
- ▶ Switch off the vehicle.

Maintenance display

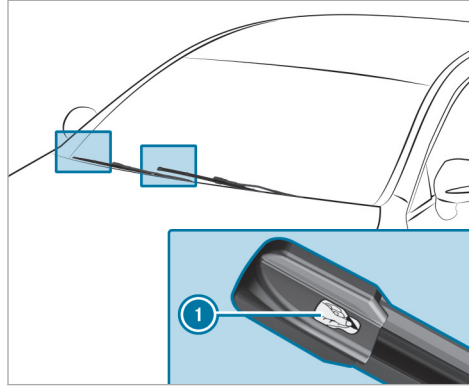
A maintenance display can be found at the tip of the blade on the newly installed wiper blades.



- ▶ Remove protective film  from the maintenance display.

When the color of the maintenance displays changes from black to yellow, you should replace the wiper blades.

Mirrors

Operating the outside mirrors

⚠ WARNING Risk of accident due to adjusting the vehicle settings while the vehicle is in motion

You could lose control of the vehicle in the following situations in particular:

- If you adjust the driver's seat, the head restraint, the steering wheel or the mirror while the vehicle is in motion
- If you fasten your seat belt while the vehicle is in motion

▶ Before starting the vehicle: in particular, adjust the driver's seat, head restraint, steering wheel and mirror, and fasten your seat belt.

⚠ WARNING Risk of accident due to misjudgment of distance when using the front-passenger mirror

The outside mirror on the front passenger side reflects objects on a smaller scale. The objects in view are in fact closer than they appear.

▶ Therefore, always look over your shoulder to check the actual distance between you and the road users traveling behind you.

Adjusting the outside mirrors

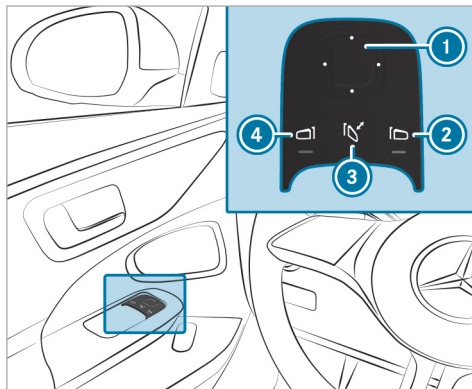

▶ Use button ② or ④ to select the desired mirror.

ⓘ In vehicles with MBUX Interior Assistant and driver camera, the required outside mirror can also be preselected automatically via a natural head movement to the left or right (→ page 315).

▶ Use button ① to adjust the position of the selected mirror.

Folding the outside mirrors in/out (vehicles with electrically folding outside mirrors)

▶ Briefly press button ③.

ⓘ If the battery has been disconnected or has discharged, the outside mirrors must be moved briefly using button ③. Only then will the automatic mirror folding function work properly.

Engaging the outside mirrors

If an outside mirror has been forcibly disengaged, proceed as follows.

▶ Vehicles without electrically folding outside mirrors: move the outside mirror into the correct position manually, until it engages audibly.

▶ Vehicles with electrically folding outside mirrors: press and hold button ③. You will hear a click and the mirror will audibly engage. The outside mirror will now be set to the correct position.

Automatic anti-glare mirrors function

▲ WARNING Risk of acid burns and poisoning due to the anti-glare mirror electrolyte

Electrolyte may escape if the glass in an automatic anti-glare mirror breaks.

The electrolyte is hazardous to health and causes irritation. It must not come into contact with your skin, eyes, respiratory organs or clothing or be swallowed.

- ▶ If you come into contact with electrolyte, observe the following:
- Immediately rinse the electrolyte from your skin with water and seek medical attention.
 - If electrolyte comes into contact with your eyes, immediately rinse them thoroughly with clean water and seek medical attention.
 - If the electrolyte is swallowed, immediately rinse your mouth out thoroughly. Do not induce vomiting. Seek medical attention immediately.

- Immediately change out of clothing which has been contaminated with electrolyte.
- If an allergic reaction occurs, seek medical attention immediately.

The inside rearview mirror and the outside mirror on the driver's side will automatically go into anti-glare mode if light from a headlamp hits the sensor on the inside rearview mirror.

System limits

The system will not go into anti-glare mode if:

- The vehicle is switched off.
- Reverse gear is engaged.
- The interior lighting is switched on.

Front-passenger outside mirror parking position function

The parking position makes parking easier.

The front-passenger outside mirror will swivel downwards in the direction of the rear wheel on the front passenger's side when:

- The parking position is stored (→ page 158).
- The front-passenger mirror is selected.
- Reverse gear is engaged.

The front-passenger outside mirror will move back to its original position when:

- You shift the transmission to another transmission position.
- You are traveling at a speed greater than 9 mph (15 km/h).
- You press the button for the outside mirror on the driver's side.

Storing the parking position of the front-passenger outside mirror using reverse gear

Storing

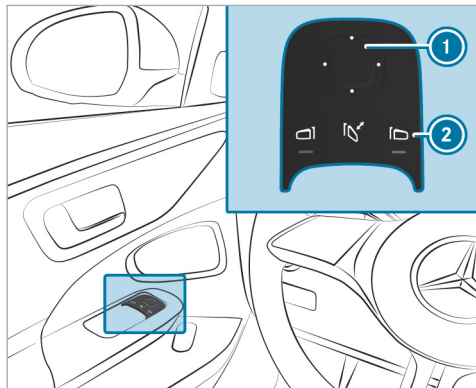

- ▶ Select the front-passenger outside mirror using button ②.
- ▶ Engage reverse gear.

- ▶ Move the front-passenger outside mirror into the desired parking position using button ①.

Calling up

- ▶ Select the front-passenger outside mirror using button ②.
- ▶ Engage reverse gear.
The front-passenger outside mirror will move into the stored parking position.

Activating/deactivating the automatic mirror folding function

Multimedia system:

- ▶  ▶ Settings ▶ Vehicle
- ▶ Opening/closing

- ▶ Activate or deactivate Automatic Mirror Folding.

Overview of climate control systems

Notes on climate control

An interior air filter in combination with the prefilter in the engine compartment must always be used so that the air conditioning system, pollution level monitoring and the air filtration work correctly. Only use filters approved by Mercedes-Benz. Always have maintenance work carried out at a qualified specialist workshop.

Note that your vehicle may not be equipped with all functions described here.

Overview of the THERMATIC climate bar

The indicator lamps indicate that the corresponding functions are activated.

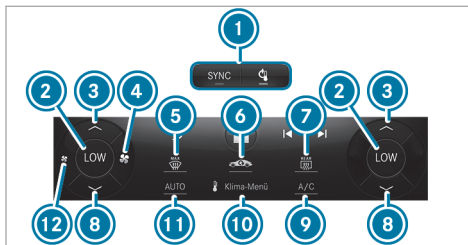

Front climate bar on the central display (example)

- ① **SYNC** Synchronization function (→ page 164)
- ② Switches climate control on/off (→ page 161)
- ③ Increases the temperature
- ④ Increases the airflow or switches on climate control (→ page 161)
- ⑤ Defrosts the windshield
- ⑥ Switches the A/C function on/off (→ page 163) or Calls up the fine particulate status display (→ page 162)

or for plug-in hybrid vehicles: Activates/deactivates pre-entry climate control

- ⑦ Switches the rear window defroster on/off
 - ⑧ Reduces the temperature
 - ⑨ Switches the A/C function on/off (→ page 163)
 - ⑩ Calls up the air-conditioning menu (→ page 162)
 - ⑪ **AUTO** Sets climate control to automatic mode (→ page 163)
 - ⑫ Reduces the airflow or switches off climate control (→ page 161)
- ⓘ The airflow will automatically be reduced in the event of an incoming call to keep noise sources to a minimum. The airflow can be adjusted again via ④.
- ⓘ The availability of individual functions depends on country and equipment.

Overview of the THERMOTRONIC climate bar

The indicator lamps indicate that the corresponding functions are activated.

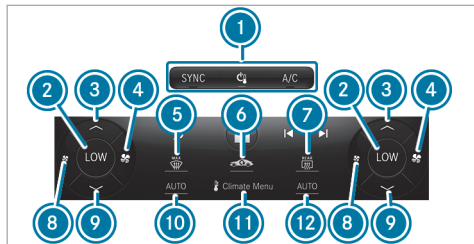

Front climate bar on the central display (example)

- ① **SYNC** Synchronization function (→ page 164)
- ② Switches climate control on/off (→ page 161)
- ③ Switches the A/C function on/off (→ page 163)
- ④ Temperature indicator example: LOW is the lowest temperature setting (driver's or front passenger side)

- ③ Increases the temperature (driver's or front passenger side)
- ④ Increases the airflow or switches on climate control (driver's or front passenger side) (→ page 161)
- ⑤ Defrosts the windshield
- ⑥ Switches the A/C function on/off (→ page 163) or Calls up the fine particulate status display (→ page 162) or Activates/deactivates residual engine heat utilization (→ page 164) or for plug-in hybrid vehicles: Activates/deactivates pre-entry climate control
- ⑦ Switches the rear window defroster on/off
- ⑧ Reduces the airflow or switches off climate control (driver's or front passenger side) (→ page 161)
- ⑨ Reduces the temperature (driver's or front passenger side)
- ⑩ **AUTO** Sets climate control to automatic mode (driver's side) (→ page 163)

- ⑪ Calls up the air-conditioning menu (→ page 162)
- ⑫ **AUTO** Sets climate control to automatic mode (front passenger side) (→ page 163)

- ⓘ The airflow will automatically be reduced in the event of an incoming call to keep noise sources to a minimum. The airflow can be adjusted again via ④.
- ⓘ The availability of individual functions depends on country and equipment.

Overview of the rear operating unit

The rear operating unit is available only for vehicles with the THERMOTRONIC air conditioning control panel.

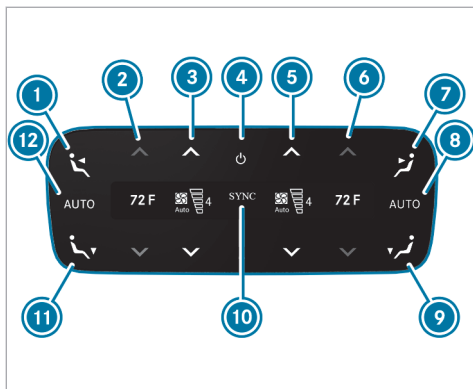

Example: USA

- ① Sets the air distribution to the center air vent in the rear passenger compartment, left
- ② Sets the temperature in the rear passenger compartment, left
- ③ Sets the airflow in the rear passenger compartment, left, or switches climate control on/off (→ page 162)
- ④ Switches climate control on/off (→ page 162)
- ⑤ Sets the airflow in the rear passenger compartment, right, or switches climate control on/off (→ page 162)
- ⑥ Sets the temperature in the rear passenger compartment, right
- ⑦ Sets the air distribution to the center air vent in the rear passenger compartment, right
- ⑧ Sets rear climate control to automatic mode, right
- ⑨ Sets the air distribution to the rear right footwell vents
- ⑩ Synchronization is activated (→ page 164)
- ⑪ Sets the air distribution to the rear left footwell vents
- ⑫ Sets rear climate control to automatic mode, left

The settings for the second row of seats can be configured via the rear operating unit or the multimedia system (→ page 164) depending on the vehicle's equipment.

Operating the climate control system

Switching climate control on/off

Switching on climate control

▶ Set the airflow to level 1 or higher via on the climate bar on the central display.

or

▶ Press and hold .

or

▶ Select and then press .

or

▶ Press .



Switching off climate control

▶ Set the airflow to level 0 via on the climate bar on the central display.

or

▶ Press .

If climate control is switched off, the windows may fog up more quickly. Switch climate control off only briefly.

- ❗ If you switch off climate control by pressing , fragrancing, if enabled, will also be switched off automatically.
- ❗ If climate control is switched off via , OFF will be shown on the climate bar.

Switching climate control on/off via the rear operating unit

Switching on

- ▶ Press button .

or

- ▶ Set the airflow to level 1 or higher using buttons  and .



or

- ▶ Press buttons , ,  or .

Switching off

- ▶ Press button .

or

- ▶ Set the airflow to level 0 using buttons  and .

- ❗ If rear climate control is switched off via button , OFF will be shown on the displays.

Activating/deactivating the A/C function via the climate bar

The A/C function heats, cools and dehumidifies the vehicle's interior air.

- ▶ Press  on the climate bar on the central display.

- ❗ Switch off the A/C function only briefly, otherwise the windows may fog up more quickly. Condensation may drip from the underside of the vehicle when cooling mode is active. This is not indicative of a malfunction.

Calling up the air conditioning menu using the climate bar

The air conditioning menu can be called up via the climate bar. The climate bar is always shown on the lower edge of the central display.

- ▶ Select the **Menu** entry in the climate bar. The **First Row of Seats** menu is opened.

Jumping directly to the Air Quality menu

- ▶ Select the  fine particle status display in the air conditioning bar. The **Air Quality** menu is opened. An animation of the automatic air cleaning taking place is shown.



- ❗ The fine particle status display is on the home screen next to the temperature display on the right and it informs you of the current particulate levels inside and outside of the vehicle. The measurement values are shown with the $\mu\text{g}/\text{m}^3$ units (micrograms per cubic meter).
- ❗ The availability of individual functions depends on the country and equipment.

Defrosting the windshield via the climate bar

Switching on

- ▶ Press  on the climate bar on the central display.

Switching off

- ▶ Press , **AUTO** or  on the climate bar on the central display.

or

- ▶ Set the airflow to 0.

- ⓘ When the defrost function is activated via , some functions (e.g. the temperature setting or the air distribution) will automatically be deactivated.

Activating/deactivating the A/C function via the air-conditioning menu

Multimedia system:

- ▶ **Climate Menu** ▶ **First Row of Seats**

Depending on the external conditions, support for improved cooling and dehumidification of the interior air will be provided when the A/C function is activated. If it is not possible to operate the A/C function on the climate bar on the central display, switch the function on or off in the climate menu of the central display.

- ▶ Select **A/C** (A/C).



Switch off the A/C function only briefly, otherwise the windows may fog up more quickly.

Condensation may drip from the underside of the vehicle when cooling mode is active. This is not indicative of a malfunction.

Setting climate control to automatic mode

In automatic mode, the set vehicle interior temperature is controlled automatically and maintained at a constant level by the air supply.

- ▶ Press **AUTO** on the climate bar on the central display.

- ⓘ You can increase or reduce the airflow via a controller by pressing  on the climate bar of the multimedia system. The airflow will automatically be reduced in the event of an incoming call. You will still be able to adjust the airflow manually by pressing . In automatic mode, five levels can be set via the controller and seven levels can be set without automatic mode.

- ▶ **To switch to manual operation:** switch off automatic mode or adjust the air distribution, e.g. .

Setting air distribution and air vents using the air conditioning menu

Multimedia system:

- ▶ **Climate Menu**

Setting the air distribution

- ▶ Select **First Row of Seats** or **Second Row of Seats**.

- ▶ Select an air distribution option using the ,  or  buttons.

- ▶ Set the airflow.

- ⓘ When the air conditioning system is switched on, at least one zone is always active. However, several air distribution options can be selected at the same time, for example to set the climate control for the vehicle interior and the footwells simultaneously. In doing so, the  climate control for the windshield can only be selected for the first seat row. When automatic mode is active, the buttons for setting the air distribution are automatically deactivated. When the air conditioning system is switched off, the buttons remain operable and the last setting is saved.

Setting rear climate control using the air conditioning menu



Multimedia system:

↳ Climate Menu



Setting the temperature

- ▶ Select **Second Row of Seats**.
- ▶ Set the temperature.

Setting the airflow

- ▶ Select **Second Row of Seats**.
- ▶ Set the air flow with  or .

Controlling the rear climate control automatically

- ▶ Select **AUTO**.
- ⓘ When the defrost function is activated, some functions (e.g. the temperature setting) will automatically be deactivated. To deactivate the defrost function, press either  **AUTO** or  set the air flow to level 0 (→ page 162).

Switching the synchronization function on/off via the air-conditioning menu

Multimedia system:

↳ Climate Menu ▶▶ First Row of Seats

The synchronization function controls the climate control centrally. The driver's settings for temperature, airflow and air distribution are automatically adopted for each climate zone.

- ▶ Select **SYNC** (SYNC).

Defrosting the windows

Windows fogged up on the inside

- ▶ Press **AUTO** on the climate bar on the central display.
- ▶ If the windows remain fogged up: press  on the climate bar on the central display.

Windows fogged up on the outside

- ▶ Switch on the windshield wiper.
- ▶ Press **AUTO** on the climate bar on the central display.

Switching air-recirculation mode on/off

Requirements:

- The THERMOTRONIC air conditioning control panel is available.

Requirements:

- The fine particulate status display is visible on the climate bar.

- ▶ Press  on the climate bar on the central display.
The interior air will be recirculated.

Air-recirculation mode will automatically switch to fresh air mode after a while.

- ⓘ If air-recirculation mode is switched on, the windows may fog up more quickly. Switch on air-recirculation mode only briefly.

Switching residual heat mode on/off via the climate bar

Requirements:

- The residual heat function is available.

- The vehicle is parked.
- The coolant temperature is sufficiently high.

It is possible to make use of the residual heat from the engine to continue heating the vehicle for approximately 30 minutes, depending on the temperature set.

▶ **To switch on or off:** select **Residual Heat** on the climate bar of the central display.

The residual heat function will automatically switch off after a while.

ⓘ If residual engine heat utilization is activated, the two buttons for setting the temperature and air distribution will automatically be deactivated.

Activating/deactivating ionization

Multimedia system:

↳ Climate Menu ▶▶ Air Quality

When ionization is activated, the air in the vehicle interior is enriched with negatively charged oxygen ions. These can promote the well-being of the vehicle occupants.

▶ Select **Ionization**.

ⓘ The function can be performed only if AUTO mode is activated or the air distribution is set to the side air vent. The function is restricted if the side air vents on the driver's side are closed.

Fragrance system

Setting the fragrance system

Requirements

- The THERMATIC (2-zone) or THERMOTRONIC air conditioning control panel is available.
- The climate control system is switched on.
- The glove compartment is closed.
- A flacon is inserted.

Multimedia system:

↳ Climate Menu ▶▶ Air Quality

▶ Select **Fragrance**.

▶ Keep pressing until the desired intensity is reached.

Inserting/removing the flacon of the fragrance system

⚠ WARNING Risk of injury from liquid perfume

If children open the flacon, they could drink the liquid perfume or it could come into contact with their eyes.

- ▶ Do not leave children unattended in the vehicle.
- ▶ Consult a doctor immediately if liquid perfume has been drunk.
- ▶ If liquid perfume comes into contact with your eyes or skin, rinse your eyes with clean water.
- ▶ If symptoms continue, consult a doctor.

 **ENVIRONMENTAL NOTE** Environmental damage due to improper disposal of full flacons



Full flacons must not be disposed of together with household waste.



Hand in full flacons at a pollutant collection point.

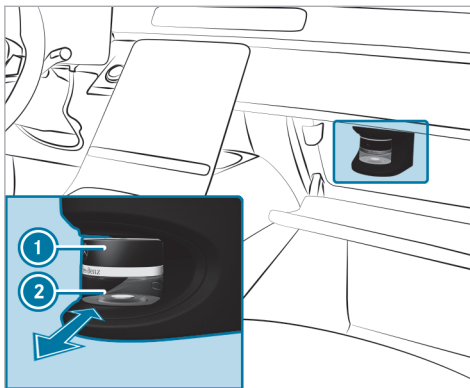

- ① Cap
- ② Flacon

- ▶ **To insert:** slide the flacon into the holder as far as it will go.
- ▶ **To remove:** After opening the glove compartment, wait for approximately seven seconds and pull out the flacon.

If you do not use genuine Mercedes-Benz interior perfumes, observe the manufacturers' safety notes on the fragrance packaging.

Dispose of the genuine Mercedes-Benz interior fragrance flacon when it is empty and do not refill it.

Refillable flacon

- ▶ Unscrew the cap of the empty flacon.
- ▶ Fill the flacon with a maximum of 0.5 fl. oz. (15 ml).
- ▶ Screw the cap back onto the flacon.

Always refill the empty refillable flacon with the same fragrance. Observe the separate information sheet attached to the flacon.

Pre-entry climate control when the vehicle is unlocked

Function of pre-entry climate control when the vehicle is unlocked

The seats can be briefly pre-heated or pre-cooled before you get into the vehicle.

i This function is available only in plug-in hybrid vehicles and some models with a 48 V on-board electrical system.

Depending on the vehicle's equipment, the following functions will be activated as needed during pre-cooling:

- Automatic climate control
- Blower
- Seat ventilation

Depending on the vehicle's equipment, the following functions will be activated as needed during pre-heating:

- Automatic climate control
- Blower
- Seat heating
- Steering wheel heater
- Mirror heater
- Rear window defroster

Depending on the vehicle's equipment, the following functions will also be adjusted during pre-entry climate control if they have already been switched on during regular vehicle operation:

- Fragrancing
- Ionization

■ Setting pre-entry climate control when the vehicle is unlocked in the multimedia system

Multimedia system:

↳ Climate Menu ▶▶ Pre-entry Climate Ctrl.

i This function is available only for plug-in hybrid vehicles.

On some models with a 48 V on-board electrical system, the pre-entry climate control function can be activated when the vehicle is unlocked via the Mercedes me app. The following requirements must be fulfilled:

- The vehicle has a wireless connection.
- The vehicle is linked to the Mercedes me user account.

▶ Activate or deactivate the function.

Selecting seats

▶ Select **Driver**, **Passenger**, **Rear Left** or **Rear Right**.

The seat-specific functions of pre-entry climate control (e.g. seat heating) will be performed for the selected seats.

When pre-entry climate control is enabled, an LED on the climate bar on the central display will light up blue for a cooled vehicle and red for a heated vehicle.

■ Activating/deactivating pre-entry climate control when the vehicle is unlocked

Requirements:

- i** This function is available only in plug-in hybrid vehicles and some models with a 48 V on-board electrical system.
- The high-voltage battery or the 48 V battery is charged sufficiently.
 - The function has been activated via the multimedia system or the Mercedes me app.

▶ **To switch on:** unlock the vehicle. The climate control functions are activated for up to five minutes for pre-heating and pre-cooling.

Pre-entry climate control when the vehicle is unlocked cannot be activated more than three times when the vehicle is switched off.

▶ **To switch off:** press  on the climate bar on the central display, or switch off via the Mercedes me App in some models with a 48 V on-board electrical system.

Depending on the vehicle equipment, the following functions will remain active once the vehicle has been started:

- Seat heating
- Seat ventilation
- Fragrancing
- Ionization

Pre-entry climate control for departure time

■ Pre-entry climate control for departure time function

⚠ WARNING Risk of fatal injury due to exposure to extreme heat or cold in the vehicle

If persons, particularly children, are subjected to prolonged exposure to intense heat or cold, there is a risk of severe injury or even death.

▶ Never leave persons, particularly children, unattended in the vehicle.

⚠ WARNING Risk of burns due to repeatedly switching on the seat heating

Repeatedly switching on the seat heating can cause the seat cushion and seat backrest padding to become very hot.

In particular, the health of persons with limited temperature sensitivity or a limited ability to react to high temperatures may be affected or they may even suffer burn-like injuries.

▶ Do not repeatedly switch on the seat heating.

To protect against overheating, the seat heating may be temporarily deactivated after it has been switched on repeatedly.

i The pre-entry climate control at departure time function is available only for plug-in hybrid vehicles.

The air inside the vehicle can be heated, ventilated or cooled to the set temperature when the vehicle is parked.

When the vehicle is connected to power supply equipment, priority will be given to charging the high-voltage battery to a specified minimum state of charge.

The running time of pre-entry climate control may be reduced in the following circumstances:

- The vehicle is not connected to power supply equipment.
- The high-voltage battery is not fully charged

With active pre-entry climate control, the state of charge of the high-voltage battery may be

reduced, even if the charging cable connector is connected.

If available, seat ventilation will be activated in the cooling and ventilation modes.

Depending on the vehicle's equipment, the following functions will be activated in heating mode, if available:

- Seat heating
- Steering wheel heater
- Mirror heater
- Rear window defroster

When the set temperature changes, climate control mode will automatically switch:

- from heating mode to ventilation or cooling mode, or
- from cooling mode to ventilation or heating mode, or
- from ventilation mode to heating or cooling mode

Setting pre-entry climate control at departure time via the multimedia system

Multimedia system:

→ Climate Menu → Pre-entry Climate Ctrl.

Setting the departure time

- ❗ The set departure times are used for the vehicle's pre-entry climate control and for predictions regarding the approximate state of charge and range at the time selected. Additional information on the charging settings: (→ page 329).

▶ Select **Edit Departure Time** .

▶ Select a departure time or set a new departure time.

Setting repeat days

▶ Select **Edit Departure Time** .

▶ Set the desired departure time and select the corresponding days on which this departure time is to apply.

▶ Press **OK** to confirm.

Selecting seats

▶ Select **Driver, Passenger, Rear Left** or **Rear Right**.

Pre-entry climate control will take place for the selected seats.

When pre-entry climate control is enabled, an LED on the climate bar on the central display will light up blue for a cooled vehicle and red for a heated vehicle. If the departure time is selected, the LED on the climate bar of the central display will light up yellow.

Activating/deactivating pre-entry climate control for departure time

Requirements:

- The vehicle has a wireless connection.
- The vehicle is linked to the Mercedes me user account.

Plug-in hybrid vehicles:

- The high-voltage battery is charged sufficiently.
- The function has been activated via the multimedia system.

Vehicles with a 48 V on-board electrical system:

- The 48 V battery is charged sufficiently.

▶ **To switch on:** Plug-in hybrid vehicles: set the departure time (→ page 169). Pre-entry climate control for departure time will switch on a maximum of 55 minutes before the selected departure time. It will remain active for another five minutes if departure is delayed.

Vehicles with 48 V on-board electrical system: pre-entry climate control at departure time can be activated via the Mercedes me app. Pre-entry climate control will switch on a maximum of five minutes before the selected departure time.

▶ **Switching off pre-entry climate control at departure time ahead of time:**

- Press  on the climate bar on the central display (see vehicle Operator's Manual).
- Switch off the preselection of the time on the climate menu.

- Vehicles with 48 V on-board electrical system: switch off the function via the Mercedes me app.

If present, the following functions will remain active once the vehicle has been started:

- Seat heating
- Seat ventilation

Depending on the vehicle's equipment, the following functions will also be adjusted during pre-entry climate control if they have already been switched on during regular vehicle operation:

- Fragrancing
- Ionization

Activating/deactivating immediate pre-entry climate control

⚠ WARNING Risk of fatal injury due to exposure to extreme heat or cold in the vehicle

If persons, particularly children, are subjected to prolonged exposure to intense heat or cold, there is a risk of severe injury or even death.

- ▶ Never leave persons, particularly children, unattended in the vehicle.

⚠ WARNING Risk of burns due to repeatedly switching on the seat heating

Repeatedly switching on the seat heating can cause the seat cushion and seat backrest padding to become very hot.

In particular, the health of persons with limited temperature sensitivity or a limited ability to react to high temperatures may be affected or they may even suffer burn-like injuries.



- ▶ Do not repeatedly switch on the seat heating.

To protect against overheating, the seat heating may be temporarily deactivated after it has been switched on repeatedly.

Requirements:

- The vehicle is switched off.

Air-conditioning of the vehicle interior can continue for up to 50 minutes for plug-in hybrids, e.g. if the journey is interrupted.

- ▶ Press  on the climate bar on the central display. The red or blue indicator lamp below  on the climate bar on the central display will light up or go out.
- ▶ Set the temperature using the arrows  on the climate bar on the central display.

The colors of the indicator lamp have the following meanings:

- **Blue:** stationary ventilation is switched on.
- **Red:** the stationary heater is switched on.
- **Yellow:** the departure time is preselected.

Air vents

Adjusting the front air vents

⚠ WARNING Risk of burns or frostbite due to being too close to the air vents



Very hot or very cold air can flow from the air vents.

- ▶ Make sure that all vehicle occupants always maintain a sufficient distance from the air vents.
- ▶ If necessary, direct the airflow to another area of the vehicle interior.

To guarantee the flow of fresh air through the air vents into the vehicle interior, note the following:

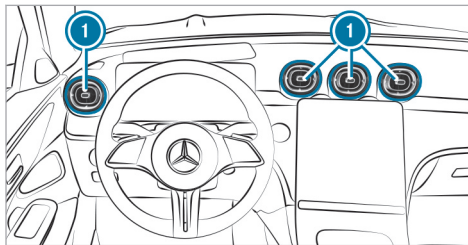

- Always keep the vents and ventilation grilles in the vehicle interior clear.
- Keep the air inlet free of residue build-up (→ page 370).

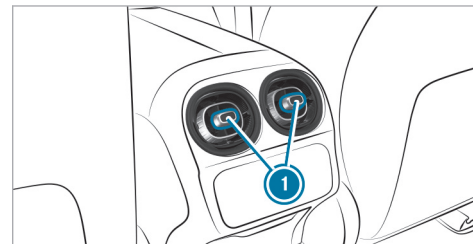

- ▶ **To open or close:** hold the center of air vent  and turn it to the left (open) or right (closed) as far as it will go.
- ▶ **To set the airflow direction:** hold the center of air vent  and move it up or down or to the left or right.

Adjusting the rear air vents



- ▶ **To open or close:** turn controller  to the left or right as far as it will go.
- ▶ **To set the airflow direction:** hold the center of controller  and move it up or down or to the left or right.

Driving

Notes on Mercedes-AMG vehicles

Observe the notes on the following topics in the supplement, otherwise you may fail to recognize potential dangers.

- ① Availability of some functions depends on the respective equipment and model.
- Reduction of engine output and engine torque
- AMG Real Performance Sound
- RACE START
- DRIFT MODE
- Boost effect strategy
- AMG RIDE CONTROL
- AMG steering wheel buttons

Notes on plug-in hybrids

Notes on plug-in hybrid operation

⚠ WARNING Risk of chemical burns and poisoning from damaged high-voltage battery

If the housing of the high-voltage battery has been damaged, electrolyte and gases may leak out.

- ▶ Avoid contact with the skin, eyes or clothing.
- ▶ Immediately rinse electrolyte splashes off with water and seek medical attention straight away.

⚠ DANGER Risk of fire and explosion from excessive internal pressure of the high-voltage battery

In the event of a vehicle fire, flammable gas can escape and ignite.

- ▶ If there is an unusual smell, smoke or burn marks, stop the charging process immediately.

- ▶ Leave the danger zone immediately. Secure the danger area at a sufficient distance.
- ▶ Call the fire service.

! NOTE Mercedes-AMG vehicles

- ▶ Observe the notes in the Supplement. You could otherwise fail to recognize dangers.

The hybrid system combines a combustion engine with an electric motor.

Characteristics when the vehicle is at a standstill:

- The combustion engine will generally be switched off.
- Idle speed will occur only in certain instances.

Characteristics when the vehicle is started:

- If the high-voltage battery is sufficiently charged, it will be possible to start the vehicle with the electric drive system without the combustion engine (noiseless start).

- If the high-voltage battery for the electric drive system is not sufficiently charged or the vehicle conditions for a silent start are not met, the vehicle will start with the combustion engine.
- ① Depending on the system, it may be that even though the high-voltage battery is charged, electric mode has restricted or no availability. When the combustion engine has run for long enough and the ambient conditions permit, electric mode will be available without restriction once more.

Characteristics with moderate power output requests:

- The combustion engine will be switched off as often as possible during a journey.
- Depending on the drive program selected and the state of charge of the high-voltage battery, the vehicle can be accelerated under electric power up to a speed of approximately 85 mph (140 km/h).

Characteristics with high power output requests:

- The electric motor will support the combustion engine (boost effect), e.g. when the vehicle is pulling away or accelerating.
- The high-voltage battery will be discharged.

Characteristics when the accelerator pedal is released during the journey:

- The electric motor will be operated as an alternator when in overrun mode and during braking.
- The high-voltage battery will be charged.

Notes on electric mode:

- Vehicles with hybrid systems generate significantly less noise when stationary and when being driven than vehicles with combustion engines.
- In electric mode, the vehicle may not be heard by other road users due to the significantly reduced noise generated when the vehicle is in motion and when at a standstill.

It is for this reason that the vehicle is equipped with a sound generator, which serves as

an acoustic vehicle alerting system (AVAS). This safety system is prescribed by law.

The external noise produced by the sound generator can be heard in the vehicle interior when the vehicle is stationary and at low speeds and does not represent a malfunction.

- If not all the vehicle conditions for electric mode are met, the combustion engine will be switched on.
- Performance restrictions in electric mode are possible as a result of the operating temperature of the high-voltage battery and drive system, the ambient temperature and aging of the high-voltage battery.
- In electric mode, the maximum power will not be permanently available and may drop to continuous output.

Notes on the acoustic vehicle alerting system:

- The sound generator will produce idling and speed-dependent driving noises up to a speed of approximately 19 mph (30 km/h).

- This will help other road users, particularly pedestrians and cyclists, to hear your vehicle better.
- From a speed of 13 mph (20 km/h), the acoustic vehicle alerting system will gradually switch off.

Manually disconnecting the high-voltage on-board electrical system

⚠ DANGER Risk of death and fire due to modified and/or damaged components of the high-voltage on-board electrical system

The vehicle's high-voltage on-board electrical system is under high voltage. If you modify component parts in the vehicle's high-voltage on-board electrical system or touch damaged component parts, you may be electrocuted. In addition, modified and/or damaged components may cause a fire.

In the event of an accident or impact to the underbody, components of the high-voltage electrical system may be damaged although the damage is not visible.

- ▶ Never make any modifications to the high-voltage on-board electrical system.
- ▶ Do not switch on or use the vehicle if its high-voltage on-board electrical system components have been modified or damaged.
- ▶ Never touch damaged components of the high-voltage on-board electrical system.
- ▶ After an accident, do not touch any components of the high-voltage on-board electrical system.
- ▶ After an accident, have the vehicle transported away.
- ▶ Have the components of the high-voltage on-board electrical system checked at a qualified specialist workshop and replaced if necessary.

Requirements

Only disconnect the high-voltage on-board electrical system manually in the following situations:

- The restraint system warning lamp  lights up in the driver display, e.g. after an accident.
- The vehicle is badly damaged, e.g. after an accident, and restraint system components have not been triggered.

Operating the high-voltage disconnect device

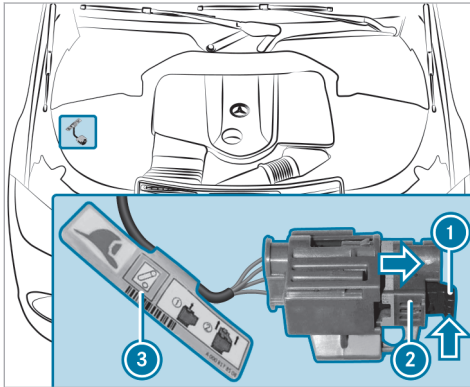

- ▶ Switch off the vehicle.
- ▶ Shift the transmission to position **P**.
- ▶ Apply the electric parking brake.
- ▶ Secure the vehicle against rolling away.
- ▶ Open the hood.

- ▶ Observe additional label **3** for high-voltage disconnect device **2**.
- ▶ Press release tab **1** in the direction of the arrow and pull it out.
- ▶ Pull high-voltage disconnect device **2** in the direction of the arrow until it engages. The high-voltage on-board electrical system is switched off.

All work on the hybrid drive system- (including after disconnecting the high-voltage on-board electrical system manually-) may only be carried out in a qualified specialist workshop.

Switching on the power supply or the vehicle

⚠ WARNING Risk of accident and injury due to children left unattended in the vehicle

If you leave children unattended in the vehicle, they could, in particular:

- open doors, thereby endangering other persons or road users.

- get out and be struck by oncoming traffic.
- operate vehicle equipment and become trapped, for example.

In addition, the children could also set the vehicle in motion by, for example:

- releasing the parking brake.
- changing the gearbox position.
- starting the vehicle.

- ▶ Never leave children unattended in the vehicle.
- ▶ When leaving the vehicle, always take the key with you and lock the vehicle.
- ▶ Keep the key out of reach of children.

This also applies to the Digital Vehicle Key.

Requirements:

- The key is in the vehicle and is detected.
- **Vehicles with Digital Vehicle Key:** a Digital Vehicle Key with drive authorization is detected.
- The brake pedal is not depressed.

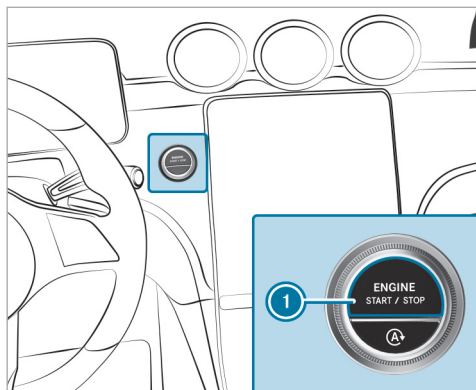

- ▶ **To switch on the power supply:** press button ① once.
You can e.g. switch on the windshield wiper.

The power supply will be switched off again if the following conditions are met:

- You open the driver's door.
- You press button ① twice more.

- ▶ **To switch on the vehicle:** press button ① twice.
Indicator and warning lamps will light up on the driver display.

The vehicle will be switched off again if one of the following conditions is met:

- You do not start the vehicle within 15 minutes and the transmission is in position **P** or the electric parking brake is applied.
- You press button ① once.

Starting the vehicle

▶ Starting the vehicle with the start/stop button

- ⚠ **DANGER** Risk of death caused by exhaust gases

Combustion engines emit poisonous exhaust gases such as carbon monoxide. Inhaling these exhaust gases is hazardous to health and leads to poisoning.

- ▶ Never leave the engine or, if present, the auxiliary heating running in an enclosed space without sufficient ventilation.

- ⚠ **WARNING** Risk of fire due to flammable materials in the engine compartment or on the exhaust system

Flammable materials may ignite.

- ▶ Therefore, regularly check that there are no flammable foreign materials in the engine compartment or on the exhaust system.

Requirements:

- The key is in the vehicle and is detected.
 - **Vehicles with Digital Vehicle Key:** a Digital Vehicle Key with drive authorization is detected.
- ▶ Shift the transmission to position **P** or **N**.
- ▶ Depress the brake pedal and press button ① once.

- ▶ If the vehicle does not start: switch off non-essential electrical consumers and press button ① once.
- ▶ If the vehicle still does not start and the **Place the Key in the Marked Space** See **Operator's Manual** display message appears on the driver display: start the vehicle with the key in the marked space (emergency operation mode) (→ page 178).

- ① You can switch off the vehicle while driving. To do this, press and hold button ① for about three seconds or press button ① three times within three seconds. Be sure to observe the safety notes concerning this under "Driving tips" (→ page 181).

Observe any information regarding display messages that may be shown on the driver display.

Starting the vehicle with the Digital Vehicle Key in the storage compartment (emergency operation mode)

Requirements:

- The vehicle is equipped with the "Digital Vehicle Key" pre-installation.

- A Digital Vehicle Key with drive authorization is detected.
- ① Alternatively, you can use the vehicle key for emergency operation mode. Mercedes-Benz recommends that the vehicle key is carried about your person as a security measure in the event of functional restrictions.

If the vehicle does not start and the **Searching for Key in Stowage Tray or Digital Vehicle Key in Inductive Charging Bracket...** See **Operator's Manual** display message appears on the driver's display, you can start the vehicle in emergency operation mode.

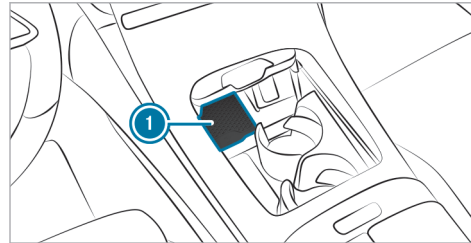

- ▶ Place the Digital Vehicle Key in marked space ①.

or

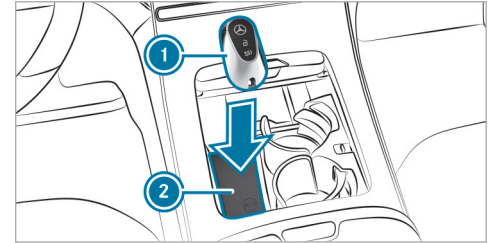

- ▶ Place vehicle key ① in marked space ②.
- ▶ Depress the brake pedal and start the vehicle using the start/stop button. It may take a few seconds until the engine starts.
- ▶ When the **Key Not Detected** display message appears on the driver's display, press the Start/Stop button again.

Starting the vehicle with the key in the storage compartment (emergency operation mode)

If the vehicle does not start and the [Place the Key in the Marked Space](#) See [Operator's Manual](#) display message appears on the driver display, you can start the vehicle in emergency operation mode.

Vehicles with Digital Vehicle Key: if the vehicle does not start and the display message reading [Searching for Key in Stowage Tray or Digital Vehicle Key in Inductive Charging Bracket...](#) See [Operator's Manual](#) appears on the driver display, you can start the vehicle in emergency operation mode.

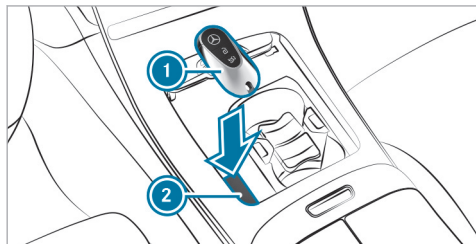

- ▶ Make sure that the storage compartment ② is empty.
- ▶ Remove key ① from the key ring.
- ▶ Place key ① in the storage compartment ② on the symbol. The vehicle will start after a short time.

If you remove key ① from the storage compartment ②, it will still be possible to continue driving the vehicle. For further engine starts, however, key ① must be located on symbol in the storage compartment ② during the entire journey.

- ▶ Have key ① checked at a qualified specialist workshop.

If the vehicle does not start:

- ▶ Place key ① in the storage compartment ② and leave it there.
 - ▶ Depress the brake pedal and start the vehicle using the start/stop button.
- ⓘ You can switch on the power supply or the vehicle with the start/stop button.

Observe any information regarding display messages that may be shown on the driver display.

Starting the vehicle via Remote Online Services

Cooling or heating the vehicle interior before a drive

Ensure the following before starting the engine:

- The legal stipulations in the area where your vehicle is parked allow engine starting via smartphone.
- It is safe to start and run the engine where your vehicle is parked.
- The fuel tank is sufficiently full.
- The starter battery is sufficiently charged.

Charging the starter battery before a drive

You can receive a message on your smartphone when the state of charge of the starter battery is low. You can then start the vehicle with the smartphone to charge the battery. The vehicle will automatically be turned off after ten minutes.

Ensure the following before starting the engine:

- The legal stipulations in the area where your vehicle is parked allow engine starting via smartphone.
- It is safe to start and run the engine where your vehicle is parked.
- The fuel tank is sufficiently full.

Starting the vehicle (Remote Online)

⚠ WARNING Risk of crushing or entrapment due to unintentional starting of the engine

Limbs could be crushed or trapped if the engine is started unintentionally during service or maintenance work.

▶ Always secure the engine against unintentional starting before carrying out maintenance or repair work.

Requirements



- Park position **P** is selected.
- The anti-theft alarm system is not activated.
- The panic alarm is not activated.

- The hazard warning lights are off.
- The hood is closed.
- The doors are closed and locked.
- The windows and sliding sunroof are closed.

▶ Start the vehicle using the smartphone. After every vehicle start, the engine runs for ten minutes.

You can carry out a maximum of two consecutive starting attempts. You must start the vehicle once with the key before starting the vehicle again with the smartphone.

You can turn off the vehicle at any time as follows:

- via the Mercedes me App
- by pushing the button  or  on the key

i Further information can be found in the Mercedes me App.

Securing the engine against starting before carrying out maintenance or repair work:

▶ Turn on the hazard warning lights or unlock the doors.

▶ Open a side window or the sliding sunroof.

Breaking-in notes

To preserve the engine during the first 1000 miles (1500 km):

- Drive at varying road speeds and engine speeds.
- Do not drive faster than 85 mph (140 km/h).
- Drive the vehicle in drive program **C** or **E**.

Plug-in hybrid: use drive program **EL**, **H** or **B**.

- Then shift to the next higher gear at the very latest when the needle reaches the last third before the red area in the tachometer.
- Do not shift down manually in order to brake.
- Avoid overstraining the vehicle, e.g. by driving at full throttle.
- Do not depress the accelerator pedal past the pressure point (kickdown).

- Increase the engine speed only gradually and accelerate the vehicle to full speed after 1000 miles (1500 km).

This also applies when the engine or parts of the drivetrain have been replaced.

Please also observe the following breaking-in notes:

- In certain handling and driving safety systems, the sensors adjust automatically while a certain distance is being driven after the vehicle has been delivered or after repairs. Full system effectiveness is reached only when this teaching-in process has concluded.
- Brake pads, brake discs and tires that are either new or have been replaced achieve optimum braking effect and grip only after the vehicle has been driven several hundred kilometers. Compensate for the reduced braking effect by applying greater force to the brake pedal.

Notes on optimize acceleration

If all necessary requirements and activation conditions are fulfilled, the best possible acceleration can be achieved from a standstill.

Do not use optimize acceleration on public roads. Individual wheels could spin and you could lose control of the vehicle. There is an increased risk of skidding and/or accident.

Be sure to observe the safety notes and information on ESP® (→ page 232).

Pulling away with optimized acceleration

⚠ WARNING Risk of skidding and accidents due to the wheels spinning

If you pull away using optimized acceleration, individual wheels can spin and the vehicle can skid.

There is an increased risk of skidding and accidents, especially when ESP® is switched off!

- ▶ Make sure that there are no persons or obstacles in the vicinity of the vehicle.

Requirements

- The vehicle is broken in (→ page 179).
- The vehicle and tires are in good condition.
- The road surface offers good grip.
- The engine and transmission are at normal operating temperature.

! **NOTE** Increased wear due to optimized acceleration

When pulling away with optimized acceleration, all components of the drivetrain are subjected to a very high load.

This can lead to increased component wear.

- ▶ Do not always pull away with optimized acceleration.

- ▶ Engage the **D** drive position (→ page 199).
- ▶ Move the steering wheel to the straight-ahead position.

- ▶ Select drive program **S** (→ page 194).
- ▶ Deactivate ESP® (→ page 233).
- ▶ Depress and hold the brake pedal firmly with your left foot.
- ▶ Fully depress the accelerator pedal with your right foot.
- ▶ After no more than five seconds, quickly take your left foot off the brake, but keep the accelerator pedal depressed. The vehicle will pull away at maximum acceleration.
- ▶ Switch on ESP® once the acceleration procedure is complete.

Ending optimized acceleration

- ▶ Remove your foot from the accelerator pedal.
 - ▶ Reactivate ESP®.
- i** After you pull away with optimized acceleration, components of the drivetrain may be very hot, which means that optimized acceleration values may possibly only be achieved again after a few minutes.

Notes on driving

⚠ WARNING Risk of accident due to objects in the driver's footwell

Objects in the driver's footwell may impede pedal travel or block a depressed pedal.

This will jeopardize the operating- and road safety of the vehicle.

- ▶ Stow all objects in the vehicle securely so that they cannot get into the driver's footwell.
- ▶ Make sure that there is always sufficient clearance for the pedals.
- ▶ Always install the floor mats securely and as prescribed.
- ▶ Do not use loose floor mats and do not place floor mats on top of one another.

⚠ WARNING Risk of accident due to incorrect footwear

Incorrect footwear includes, for example:

- Shoes with platform soles
- Shoes with high heels
- Slippers

There is a risk of an accident.

- ▶ Always wear suitable footwear so that you can operate the pedals safely.

⚠ WARNING Risk of accident if the vehicle is switched off while driving

If you switch off the vehicle while driving, safety functions are restricted or no longer available.

This may affect the power steering system and the brake force boosting, for example.

You will need to use considerably more force to steer and brake, for example.

- ▶ Do not switch off the vehicle while driving.

⚠ DANGER Risk of death caused by exhaust gases

Combustion engines emit poisonous exhaust gases such as carbon monoxide. Inhaling these exhaust gases is hazardous to health and leads to poisoning.

- ▶ Never leave the engine or, if present, the auxiliary heating running in an enclosed space without sufficient ventilation.

⚠ WARNING Risk of skidding and of an accident due to shifting down on slippery road surfaces

If you shift down on slippery road surfaces to increase the engine braking effect, the drive wheels may lose traction.

- ▶ Do not shift down on slippery road surfaces to increase the engine braking effect.

⚠ DANGER Risk of fatal injury due to poisonous exhaust gases

If the tailpipe is blocked or sufficient ventilation is not possible, poisonous exhaust gases such as carbon monoxide may enter the vehicle. This is the case, for example, if the vehicle gets stuck in the snow.

- ▶ Keep the tailpipe and the area around the vehicle free from snow when the engine or the stationary heater is running.
- ▶ Open a window on the side of the vehicle facing away from the wind to ensure an adequate supply of fresh air.

⚠ WARNING Risk of accident and injury due to being under the influence of alcohol and drugs while driving

Drinking and driving and/or taking drugs and driving are very dangerous combinations. Even a small amount of alcohol or drugs can affect your reflexes, perceptions and judgment.

The possibility of a serious or even fatal accident are greatly increased when you drink or take drugs and drive.

- ▶ Do not drink or take drugs and drive or allow anyone to drive who has been drinking or taking drugs.

⚠ WARNING Risk of accident due to the brake system overheating

If you leave your foot on the brake pedal when driving, the brake system may overheat.

This increases the braking distance and the brake system can even fail.

- ▶ Never use the brake pedal as a footrest.
- ▶ Do not depress the brake pedal and the accelerator pedal at the same time while driving.

! NOTE Engine damage due to excessively high engine speeds

The engine will be damaged if you drive with the engine in the overrevving range.

- ▶ Do not drive with the engine in the over-revving range.

! **NOTE** Wearing out the brake linings by continuously depressing the brake pedal

- ▶ Do not depress the brake pedal continuously whilst driving.
- ▶ To use the braking effect of the engine, shift to a lower gear in good time.

! **NOTE** Damage to the drivetrain and engine when pulling away

- ▶ Do not warm up the engine while the vehicle is stationary. Pull away immediately.
- ▶ Avoid high engine speeds and driving at full throttle until the engine has reached its operating temperature.

! **NOTE** Damage to the catalytic converter due to non-combusted fuel

The engine is not running smoothly and is misfiring.

Non-combusted fuel may get into the catalytic converter.

- ▶ Only depress the accelerator pedal slightly.
- ▶ Have the cause rectified immediately at a qualified specialist workshop.

! **NOTE** Reduced battery life due to frequent short-distance trips

The 12 V battery may not be sufficiently charged when the vehicle is used only for short-distance trips. This reduces the life of the battery.

- ▶ Drive longer distances regularly to charge the battery.

! **NOTE** Vehicle damage due to failure to observe the maximum permissible clearance height

If the vehicle height exceeds the maximum permissible clearance height, the roof and other vehicle parts may be damaged.

- ▶ Please observe the maximum clearance height indicated.
- ▶ If the vehicle exceeds the permissible clearance height, do not drive in.
- ▶ Take the modified vehicle height into account in the case of roof superstructures or other carrier systems.

i Please bear in mind that all speed values stated in this Operator's Manual are approximate and are subject to a certain tolerance.

Observe the notes on driving with a roof load, trailer or fully laden vehicle.

Driving with a loaded roof luggage rack or trailer, or with the vehicle fully laden or occupied, changes the handling and steering characteristics of your vehicle.

Therefore please observe the following notes:

- Do not exceed the permissible roof load and trailer load. Also observe the information in the technical data in this respect.
- Distribute the roof load and vehicle load evenly, and place heavy objects at the bottom. Also comply with the notes on loading the vehicle. (→ page 119)
- Drive carefully, avoiding abrupt starting, braking and steering as well as fast cornering.

Notes on driving on roads treated with de-icing salt

The braking effect is limited on road surfaces treated with de-icing salt.

Please therefore bear in mind the following notes:

- Due to salt build-up on the brake discs and brake linings, the braking distance can increase considerably or braking may be one-sided.
- Maintain a much greater safety distance to the vehicle traveling ahead.

Remove salt build-up as follows:

- Brake occasionally, paying attention to the traffic conditions
- Carefully depress the brake pedal at the end of the journey and when starting the next journey

Notes on hydroplaning

Hydroplaning can take place if a certain depth of water has built up on the road surface.

Observe the following notes in heavy precipitation or in conditions in which hydroplaning may occur:

- Reduce speed.
- Avoid tire ruts.
- Avoid sudden steering movements.
- Brake carefully.

i Also observe the notes on regularly checking wheels and tires (→ page 405).

Notes on driving through water on the road

Water ingress can damage the engine, electrics and transmission.

Water can also enter the air intake of the engine and cause engine damage.

Observe the following if you need to drive through water:

- The water, when calm, should reach no higher than the lower edge of the vehicle body.
- Drive at a walking pace at most, otherwise water may enter the vehicle interior or engine compartment.
- Vehicles traveling ahead, or oncoming vehicles, can create waves that may exceed the maximum permissible depth of water.

The braking effect of the brakes is reduced after fording. Brake carefully, paying attention to the traffic conditions, until braking power has been fully restored.

Function of rear axle steering

The rear axle steering is an electromechanical auxiliary steering on the rear axle which adjusts the steering of the rear wheels according to the position of the front wheels, depending on the

speed. This results in greater mobility and improved driving stability for the vehicle.

Rear axle steering has the following characteristics:

- reduced steering effort and turning circle resulting in reduced parking effort
- more direct steering resulting in improved control of the vehicle
- improved cornering of the vehicle

ECO start/stop function

■ ECO start/stop function

- ⓘ **Plug-in hybrid:** this function is not available.
- ⓘ Depending on the engine, the ECO start/stop function is not available in all drive programs. Observe the status indicator on the driver display concerning this.

The engine will be switched off automatically in the following situations if all vehicle conditions for an automatic engine stop are met:

- You brake the vehicle to a standstill in transmission position **D** or **N**.
- You depress the brake pedal when traveling at a low speed.

If the system has detected one of the following situations, the engine will not stop:





- You stop at a stop sign and there is no vehicle in front of you.
- The vehicle that stopped in front of you pulls away again.
- You maneuver, turn the steering wheel sharply or engage reverse gear.

- ⓘ If the system detects an intelligent stop inhibitor, e.g. a stop sign, the engine will not stop. If you activate the HOLD function or engage park position **P**, the engine can be switched off in spite of an intelligent stop inhibitor.

The engine will restart automatically in the following cases:

- You engage transmission position **D** or **R**.
- You depress the accelerator pedal.
- The vehicle requires an automatic engine start.
- You release the brake pedal.
- You release the brake pedal on a downhill gradient and the vehicle does not roll.
- The vehicle rolls on a downhill gradient and does not automatically enter glide mode at 15 mph (20 km/h).

ECO start/stop function symbols on the driver display:

- The  symbol (green) appears when the vehicle is at a standstill: the engine was switched off by the ECO start/stop function.
- The  symbol (yellow) appears when the vehicle is at a standstill: not all vehicle conditions for an engine stop have been met.
- Neither the  symbol nor the  symbol appears when the vehicle is at a standstill: an

intelligent stop inhibitor, e.g. a stop sign, has been detected.

- The  symbol appears: the ECO start/stop function is deactivated or there is a malfunction.

If the engine was switched off by the ECO start/stop function and you leave the vehicle, a warning tone will sound and the engine will not be restarted. In addition, the following display message will appear on the driver display:

Vehicle is Ready to Drive Switch Off Vehicle Before Exiting



If you do not switch off the vehicle, it will automatically be switched off after three minutes.

Switching the ECO start/stop function on/off

NOTE Mercedes-AMG vehicles

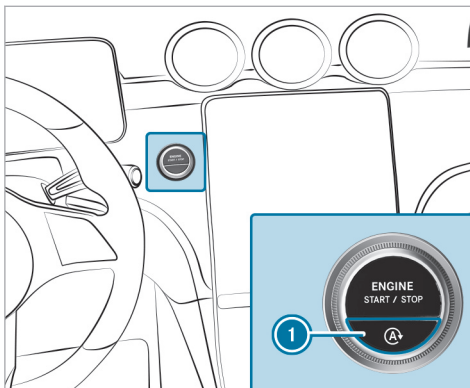
- ▶ Observe the notes in the Supplement. You could otherwise fail to recognize dangers.



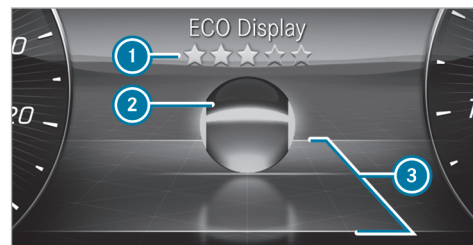

- ▶ Press button . A symbol will appear on the driver display when you switch the ECO start/stop function on/off.
-   will be shown permanently on the driver display while the ECO start/stop function is deactivated.

ECO display function



The ECO display shows an evaluation of your driving style on the driver display depending on the situation. This enables you to check the efficiency of your driving style and adjust it if necessary. The **ECO Display** menu shows a ball  that will roll forwards or backwards in the direction of travel on a stylized road according to the driving characteristics.

Above and below the road, lines mark the area for an efficient driving style . Ball  will light up in green if it is rolling within these lines. Outside the lines, the ball will light up in orange.

The ECO display assesses the following criteria for an economical driving style:

- Coasting at the right times
- Consistent speed
- Moderate acceleration

The overall assessment of your driving style "from start" is indicated using stars ❶. It starts with five empty stars, which you can fill one after the other if you drive efficiently. When all five stars are filled, a glow will appear in the background.

- ❶ You can call up the **ECO Display** function via the **Classic** menu (→ page 297).

ECO Assist function (vehicles with 48 V on-board electrical system)

For plug-in hybrids, note the ECO Assist information (→ page 190).

- ❶ ECO Assist is active only in drive programs **[E]** and **[C]**.

ECO Assist analyzes data for the vehicle's expected route. This allows the system to optimally adjust the driving style for the route ahead, save

fuel and recuperate. If the system detects an event ahead and the vehicle nears the event, ECO Assist will calculate the optimum speed for maximum fuel economy and recuperative energy based on the distance, speed and downhill gradient.

If the deceleration provided by ECO Assist is not sufficient, you must also brake with the service brake. This is especially the case if, for example, you pull away again in slow-moving traffic and the distance to the vehicle in front is very short.

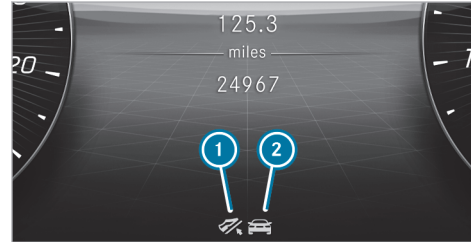



- ❶ "Foot off the accelerator" recommendation
 ❷ Route event ahead







If a route event ahead or a vehicle driving in front is detected which requires an adjustment to your driving style to ensure greater efficiency, corresponding symbol ❷ and the  symbol will be displayed in gray.

If you release the accelerator pedal, the  symbol will turn green and recuperation in over-run mode will be initiated. If the deceleration is not sufficient, also apply the service brake. If ECO Assist intervenes for a route event ahead (not for a vehicle in front) and you then press the accelerator pedal again, you end ECO Assist's control.

The ECO Assist display is hidden again in the following cases:

- You do not react to the ECO Assist recommendation for a long time.
- You press the accelerator pedal while ECO Assist is intervening for a route event ahead (not for a vehicle in front).
- ECO Assist cannot identify any further recommendations from the route ahead.

In addition to a vehicle in front , ECO Assist can detect the following route events  depending on the vehicle's equipment:

-  Traffic circle
-  Sharp bend
-  Intersection
-  T-intersection
-  Downhill gradient
-  Speed limit

 In drive program , ECO Assist reacts only to the "Vehicle in front" route event .

System limits

If the calculated route is adhered to when route guidance is active, ECO Assist will operate with greater accuracy. The basic function is also available without active route guidance. Not all information and traffic situations can be foreseen. The quality depends on the map data.

ECO Assist is only an aid. The driver is responsible for keeping a safe distance from the vehicle in front, for vehicle speed and for braking in good time.

The system may be impaired or may not function in the following situations:



- If there is poor visibility, e.g. due to insufficient illumination of the road, highly variable shade conditions, rain, snow, fog or heavy spray.
- If there is glare, e.g. from oncoming traffic, direct sunlight or reflections.
- If the windshield is dirty in the vicinity of the multifunction camera.
- If the multifunction camera is fogged up, damaged or obscured.
- If road signs are hard to detect, e.g. due to dirt, snow or insufficient lighting, or because they are obscured.
- If the digital road map of the navigation system has incorrect or outdated information.
- If signs are ambiguous, e.g. road signs in roadworks or in adjacent lanes.
- If the radar sensors are dirty or obscured.
- When you drive on roads with steep uphill or downhill gradients.

- If there are narrow vehicles in front, such as bicycles or motorcycles.

Regenerative brake system (plug-in hybrid)

Function of the regenerative brake system

The recuperative brake system converts the vehicle's kinetic energy into electrical energy during overrun mode and braking.

Depending on the selected recuperation level, the electric motor is operated as an alternator when in overrun mode and during braking in order to charge the high-voltage battery while driving. As soon as you take your foot off the accelerator while driving in transmission position  or , recuperation starts in overrun mode.

The higher the recuperation, the more sharply the vehicle is braked when coasting and the more electrical energy is fed into the high-voltage battery.

The deceleration in overrun mode may not be sufficient depending on the driving situation. There is no deceleration to a standstill. Also brake with the service brake if necessary. Always adapt your

speed to the driving situation and keep sufficient distance.

- ❗ If you brake heavily, the mechanical brake is also used. This means that the maximum recuperation energy cannot be recovered. The more proactively you accelerate and brake, the more efficiently energy can be recuperated.

System limits

With recuperation in overrun mode, the braking effect of the electric motor is only reduced or non-existent in the following situations:

- when the high-voltage battery state of charge increases
- if the high-voltage battery is not yet at a normal operating temperature

Manually setting recuperative deceleration

! NOTE Mercedes-AMG vehicles

- ▶ Observe the notes in the Supplement. You could otherwise fail to recognize dangers.

- ❗ You can use the steering wheel paddles to adjust the intensity of recuperation on the overrun in drive modes **[H]**, **[B]** and **[EL]** in transmission position **[D]**.

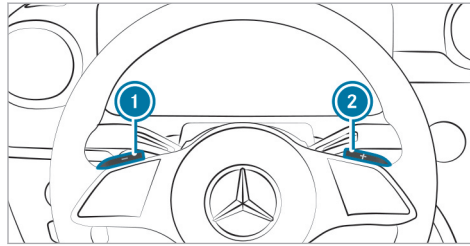

The following recuperation levels are available:

- **[D AUTO]** Intelligent, anticipatory recuperation with ECO Assist (→ page 190)
- **[D +]** No recuperation: the vehicle rolls freely
- **[D]** Normal recuperation
- **[D -]** Increased recuperation: strong vehicle deceleration on the overrun, e.g. for driving on a downhill gradient

Default setting:

- **[D AUTO]**: If the ECO Assist function in the multimedia system is switched on (→ page 191).
 - **[D]**: If the ECO Assist function in the multimedia system is switched off.
- ❗ **[D AUTO]** is only available if the ECO Assistant function in the multimedia system is switched on and if the function of the radar sensors is not impaired. Please also note the information on the vehicle sensors and cameras (→ page 229).
- ▶ Select transmission position **[D]**.
 - ▶ **Increase recuperation:** Pull the shift paddle **1** briefly.
 - ▶ **Reduce recuperation:** Pull the shift paddle **2** briefly.
 - ▶ **Default setting:** Pull the shift paddle **1** or **2** for longer or engage the transmission position **[D]** again.
- ❗ When the vehicle is started again, the standard setting is also set.

When changing to the transmission position **R**, the current recuperation level is adopted with the exception of **D AUTO**. If **D AUTO** was previously selected, the vehicle deceleration of the recuperation stage **D** is set in transmission position **R**. With a subsequent change to the transmission position **D**, the previously selected variable recuperation **D AUTO** is set again.

The driver display shows the currently set recuperation level next to the transmission position display.

ECO Assist (plug-in hybrid)

ECO Assist function

- i** The following function depends on the equipment and the country.

ECO Assist analyzes data for the vehicle's expected route. This allows the system to help optimally adjust your driving style for the route ahead, save fuel and recuperate. If the system detects an event ahead and the vehicle nears the event, ECO Assist will calculate the optimum speed for maximum fuel economy and recuperative energy

based on the distance, speed and downhill gradient.

If the deceleration provided by ECO Assist is not sufficient, you will also need to brake with the service brake. This will be the case particularly if, for example, you pull away again in slow-moving traffic and the distance to the vehicle in front is very short.

The function will be active in the following circumstances:

- The function is activated in the multimedia system (→ page 191).
- The **D AUTO** recuperation level is selected (→ page 189).
- **M** manual gearshifting is not activated.
- Drive program **S** is not selected.

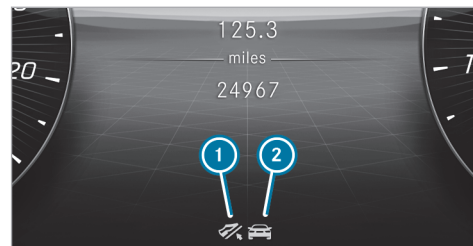

- 1 "Foot off the accelerator" recommendation
- 2 Route event ahead



If a route event that you can deal with more efficiently by adjusting your driving style is detected ahead, corresponding symbol **2** and the  symbol will be displayed in gray.







If you release the accelerator pedal, the  symbol will turn green and recuperation in overrun mode will be initiated. If the deceleration is not sufficient, also apply the service brake.

If ECO Assist intervenes for a route event ahead and you press the accelerator pedal, you will end control by ECO Assist. This does not apply in the case of a vehicle in front.

The ECO Assist display will be hidden again in the following cases:

- You do not react to the ECO Assist recommendation for a long time.
- You depress the accelerator pedal while ECO Assist is intervening because of a route event ahead. This does not apply in the case of a vehicle in front.
- ECO Assist cannot identify any further recommendations from the route ahead.

In addition to a vehicle in front , ECO Assist can detect the following route events  depending on the vehicle's equipment:

-  Traffic circle
-  Sharp bend
-  Intersection
-  T-intersection
-  Downhill gradient
-  Speed limit

System limits

If the calculated route is adhered to when route guidance is active, ECO Assist will operate with greater accuracy. The basic function is also available when route guidance is not active. Not all information and traffic situations can be foreseen. The quality depends on the map data.

ECO Assist is only an aid. The driver is responsible for keeping a safe distance from the vehicle in front, for vehicle speed and for braking in good time.

The system may be impaired or may not function in the following situations:

- if there is poor visibility, e.g. owing to insufficient road illumination, highly variable shadows, rain, snow, fog or heavy spray
- if there is glare, e.g. from oncoming traffic, direct sunlight or reflections
- if the windshield is dirty in the vicinity of the multifunction camera
- if the multifunction camera is fogged up, damaged or obscured

- if road signs are hard to detect, e.g. due to dirt, snow or insufficient lighting, or because they are obscured
- if the digital road map of the navigation system has incorrect or outdated information
- if signs are ambiguous, e.g. road signs in roadworks or in adjacent lanes
- if the radar sensors are dirty or obscured
- when you drive on roads with steep gradients
- if there are narrow vehicles in front, such as bicycles or motorcycles

■ Activating and deactivating ECO Assist

Multimedia system:

  **» Settings » Assistance**
» Driving

 Activate or deactivate the function.

Function of the route-based operating-mode strategy (plug-in hybrid)

- ① The following function is country-dependent and available only in conjunction with an integrated navigation system.

The route-based operating-mode strategy will be active in the following circumstances:

- Drive program **[H]** is selected .
- The **Route Based** option is selected for drive program **[H]** on the **DYNAMIC SELECT** menu (→ page 194).
- Route guidance is active.
- The state of charge of the high-voltage battery is sufficient.

When the function is active, data on the further course of the route will be evaluated. This includes e.g. road type, speed limits and elevation data.

The hybrid system will then adapt the operating strategy to the further course of the route:

- Use of electrical energy and the combustion engine will be adapted.

- The state of charge of the high-voltage battery will be controlled accordingly.
- Electrical energy will be reserved especially for electric mode, e.g. urban route sections or areas with low emission zones.
- The vehicle will automatically select the operating mode.

Function of the haptic accelerator pedal (plug-in hybrid)

The haptic accelerator pedal has an additional pressure point followed by increased pedal resistance to help you drive in all-electric mode.

Characteristics of the additional pressure point:

- Available only in the **[EL]** drive program
- Is used when the electric drive support power availability display is full (POWER)
- Indicates the maximum available electric performance

The subsequent increased pedal resistance indicates that the journey is being continued with the combustion engine.

DYNAMIC SELECT

Function of DYNAMIC SELECT

! NOTE Mercedes-AMG vehicles

- ▶ Observe the notes in the Supplement. You could otherwise fail to recognize dangers.

DYNAMIC SELECT allows a drive program to be selected quickly according to the current driving conditions or the desired vehicle characteristics. You will be able to select the following drive programs.

- ① Depending on the engine and equipment, the vehicle will have different drive programs.

The drive program selected will appear on the driver display.

[I*] Individual

- Custom settings (→ page 194)

[S] Sport+

- Very sporty driving

- Emphasises the vehicle's own oversteer and understeer characteristics for an even more active driving style
- Suitable only for good road conditions, a dry surface and a clear stretch of road

S Sport

- Maximum drive output is available
- Sporty driving
- Sporty, but with an emphasis on stability
- Enables a sporty driver to adopt a more active driving style
- Suitable only for good road conditions, a dry surface and a clear stretch of road

H Hybrid (plug-in hybrid)

- Comfortable and economical driving
- Balance between traction and stability
- Recommended for all road conditions
- Full development of all intelligent hybrid functions
- Adjustable recuperation in overrun mode

- The selection of the appropriate drive type by the hybrid system depends on the driving conditions and the route

C Comfort

- Comfortable and economical driving
- Balance between traction and stability
- Recommended for all road conditions

EL Electric (plug-in hybrid)

- Electric mode – driving without the combustion engine is possible up to approximately 87 mph (140 km/h)
- Adjustable recuperation in overrun mode
- Adaptation of Active Distance Assist DISTRONIC for electric mode
- Depending on the equipment, the maximum set speed for cruise control and Active Distance Assist DISTRONIC can be limited to the maximum speed possible in electric mode
- Activation of the combustion engine via the pressure point of the accelerator pedal (kick-down)

B Battery Hold (plug-in hybrid)

- Prioritises maintaining the state of charge of the high-voltage battery, e.g. for subsequent journeys in inner cities/low-emission zones
- The selection of the appropriate drive type by the hybrid system depends on the driving conditions and the route
- Adjustable recuperation in overrun mode

E Eco

- Particularly economical driving
- Balance between traction and stability
- Recommended for all road conditions

i The ESP® settings in drive programs **E** and **C** are designed for stability. Therefore, choose one of these drive programs especially when transporting roof loads, in trailer operation and when the vehicle is fully laden or fully occupied.

Plug-in hybrid: this also applies to drive programs **H**, **EL** and **B**.

Depending on the drive program, the following systems will change their characteristics:

- Drive
 - Engine and transmission management
 - Active Distance Assist DISTRONIC
 - Availability of Glide mode
- ESP®
- Steering

Selecting the drive program

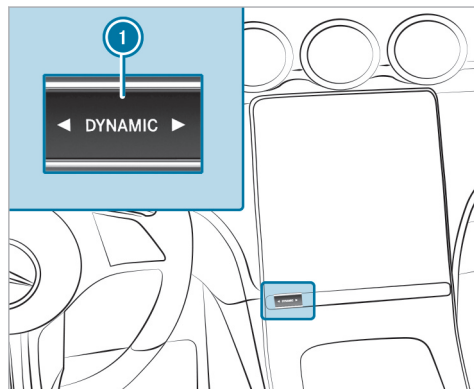

- ▶ Press DYNAMIC SELECT button ① on the left or right.
The drive program selected appears on the driver display.

Configuring DYNAMIC SELECT in the multimedia system

Multimedia system:

- ▶ Settings ▶ Vehicle
- ▶ DYNAMIC SELECT

Setting the I drive program

- ▶ Select **I** Individual.
- ▶ Select and set a category.
- ⓘ A sporty ESP mode can be set in conjunction with a sporty suspension mode.

Setting the H drive program (plug-in hybrid)

- ▶ Select **Hybrid**.
- ▶ Select **Route Based** or **Standard**.
If route guidance is active and the **Route Based** option has been activated, the electrical energy is distributed intelligently over the entire route. In built-up areas, electric mode is preferred, while on the freeway the combustion engine is used.
- ▶ With the **Standard** option, the vehicle drives in its standard drive program (**EL** Electric or

H Hybrid). There is no distribution of electrical energy over the entire route. The high-voltage battery is exhausted and the vehicle is then driven by the combustion engine.

Switching the reset display on/off

▶ Activate or deactivate **Request at Start**.

i This function must be activated for each user profile separately. Only when this function is activated will the drive program and ECO start/stop setting for the previous journey be saved for the respective user profile.

Function on: the next time the vehicle is started a prompt appears asking whether the last active drive program should be restored. If the ECO start/stop function was deactivated, an additional prompt appears asking if the function should remain deactivated.

i The prompt appears only if the previously active settings deviate from the standard settings.

Function off: the next time the vehicle is started the **C** drive program is set automatically. The

ECO start/stop function is activated automatically.

Displaying vehicle data

Multimedia system:



▶ Select **Vehicle**.
The vehicle data is displayed.

Displaying engine data

Multimedia system:



▶ Select **Engine**.
The engine data is displayed.

i The actual (maximum) values that can be achieved for engine output and engine torque may deviate from the certified values within the country-specific guidelines for permissible tolerances (basis: UN-ECE No. 85 or country-specific guidelines).

Influencing variables include:

- Sea level
- Fuel quality
- Outside temperature
- Operating temperature of the engine

Adjust your driving style accordingly.

The  warning lamp in the driver display is on until the engine has reached operating temperature.

- i** The values displayed serve only as guidance. The values for engine output and engine torque shown on the central display may deviate from the actual values.
- i** The  warning lamp to show the power output limitation after starting the vehicle is not available in all vehicle models.

Calling up the consumption indicator

Multimedia system:



- ▶ Select **Consumption**.
The current and average consumption figures will be displayed.

Automatic transmission

DIRECT SELECT lever

Function of the DIRECT SELECT lever

⚠ WARNING Risk of accident due to incorrect gearshifting

If the engine speed is higher than the idle speed and you engage the transmission position **D** or **R**, the vehicle may accelerate sharply.

- ▶ If you engage the transmission position **D** or **R** when the vehicle is at a standstill, always depress the brake pedal

firmly and do not accelerate at the same time.

⚠ WARNING Risk of accident and injury due to children left unattended in the vehicle

If you leave children unattended in the vehicle, they could, in particular:

- open doors, thereby endangering other persons or road users.
- get out and be struck by oncoming traffic.
- operate vehicle equipment and become trapped, for example.

In addition, the children could also set the vehicle in motion by, for example:

- releasing the parking brake.
- changing the gearbox position.
- starting the vehicle.

- ▶ Never leave children unattended in the vehicle.

- ▶ When leaving the vehicle, always take the key with you and lock the vehicle.
- ▶ Keep the key out of reach of children.

⚠ WARNING Risk of accident- and injury when the transmission position is not engaged

The current transmission position will be highlighted on the driver display.

If the selected transmission position is not highlighted, the vehicle may pull away in the wrong direction or roll away.

- ▶ After changing the transmission position, always check the transmission position indicator on the driver display.

If the transmission position is not highlighted on the driver display even after a short time:

- ▶ Pay attention to the display messages.
- ▶ Pull away carefully and check the engaged transmission position.

- ▶ When parking, engage the parking brake and secure the vehicle against rolling away.
- ▶ Have the transmission checked immediately at a qualified specialist workshop.

Use the DIRECT SELECT lever to switch the transmission position. The current transmission position will be highlighted on the driver display.

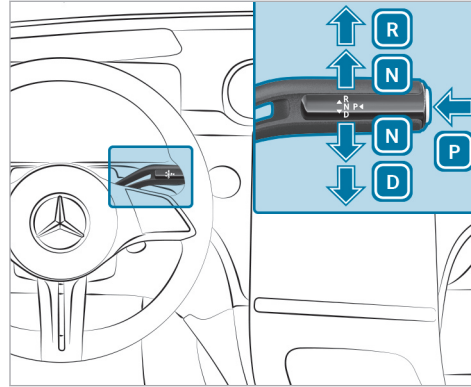

- P** Park position
- R** Reverse gear
- N** Neutral
- D** Drive position

Engaging reverse gear R

- ▶ Depress the brake pedal and push the DIRECT SELECT lever upwards past the first point of resistance.

Engaging neutral N

- ▶ Depress the brake pedal and push the DIRECT SELECT lever up or down to the first point of resistance.
- ⓘ To shift into neutral **N** with the vehicle switched on, push the selector lever up or down for several seconds to the first point of resistance.

Subsequently releasing the brake pedal will allow you to move the vehicle freely, e.g. to push it or tow it away.

Proceed as follows if you want the automatic transmission to remain in neutral **N**, even if the vehicle is switched off or the driver's door is opened:

- ▶ Depress the brake pedal and engage neutral **N** when the vehicle is at a standstill.
- ▶ Release the brake pedal.
- ▶ Switch off the vehicle.

The **Risk of Vehicle Rolling Away N Activated Manually No Automatic Change to P** message will appear on the driver display.

- ❗ If you then exit the vehicle leaving the key in the vehicle, the automatic transmission will remain in neutral **[N]**.

Vehicles with Digital Vehicle Key: Make sure that a vehicle key or Digital Vehicle Key is in the vehicle and that the automatic transmission remains in neutral **[N]**.

If the automatic transmission does not stay in neutral **[N]**:

- Restart the vehicle and repeat the procedure.

Park position **[P]** will automatically be re-engaged as soon as one of the following conditions is met:

- You switch to transmission position **[D]** or **[R]**.
- You press the button **[P]**.

■ Engaging park position P

I NOTE Damage due to engaging park position **[P]** while the vehicle is rolling

If you shift the transmission into park position **[P]** while the vehicle is rolling, the transmission may be damaged.

- ▶ If the vehicle is rolling, do not open a door.
- ▶ Only engage park position **[P]** when the vehicle is stationary.

- ▶ Observe the notes on parking the vehicle (→ page 220).
- ▶ Depress the brake pedal until the vehicle comes to a standstill.
- ▶ When the vehicle is stationary, press button **[P]**.
When the **[P]** transmission position display is shown, park position is engaged. If the **[P]** transmission position display is not shown, apply the parking brake and secure the vehicle to prevent it from rolling away.

- ❗ Depending on the situation, it may take a short time until **[P]** is engaged. Therefore, always pay attention to the transmission position display.

Park position **[P]** will be engaged automatically if one of the following conditions is met:

- You switch the stationary vehicle off in transmission position **[D]** or **[R]**.
 - You open the driver's door when the vehicle is stationary in transmission position **[D]** or **[R]**.
 - When the vehicle is rolling, you switch it off in transmission position **[D]** or **[R]** and bring it to a standstill.
 - When the vehicle is rolling, you shift to transmission position **[N]**, bring the vehicle to a standstill and open the driver's door when the vehicle is stationary.
 - Engaging park position **[P]** automatically is required by the vehicle.
- ❗ To maneuver with the driver's door open, open the driver's door while the vehicle is stationary and engage transmission position **[D]** or **[R]** again.

Engaging drive position D

- ▶ Depress the brake pedal and push the DIRECT SELECT lever down past the first point of resistance.

When the automatic transmission is in transmission position **D**, it will shift gears automatically. This depends, among other things, on the following factors:

- The selected drive program
- The position of the accelerator pedal
- The vehicle speed

Manual gearshifting

! NOTE Mercedes-AMG vehicles

- ▶ Observe the notes in the Supplement. You could otherwise fail to recognize dangers.

- ⓘ For plug-in hybrids, observe the information regarding the regenerative brake system (→ page 188).

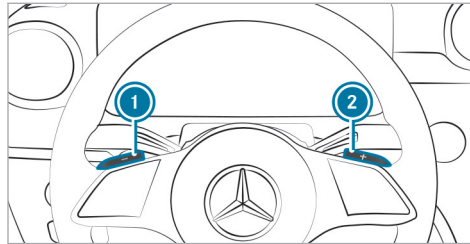

When the automatic transmission is shifted to position **D**, you can shift it manually with the steering wheel paddle shifters. If permitted, the automatic transmission will shift to a higher or lower gear depending on the steering wheel paddle shifter pulled.

You have two options for manually shifting the automatic transmission:

- Temporary setting
- Permanent setting

The gears are shifted automatically when manual shifting is deactivated.

Temporary setting:

- ▶ **To activate:** pull steering wheel paddle shifter **1** or **2**. Manual shifting will be activated for a short time. The transmission position display will show **M** and the current gear.

- ⓘ How long manual shifting stays activated depends on various factors.

Manual shifting can be deactivated automatically in the following cases:

- When the drive program is changed
- When the vehicle is restarted
- When transmission position **D** is engaged again
- Driving style

- ▶ **To shift up:** pull steering wheel paddle shifter **2**.

- ▶ **To shift down:** pull steering wheel paddle shifter **1**.

- ▶ **To deactivate:** pull and hold steering wheel paddle shifter **2**. The transmission position display will show **D**.

-  You can activate or deactivate manual shifting permanently in the multimedia system.

Permanently activating/deactivating manual shifting

Multimedia system:



 **Settings** **Vehicle** **Driving**

-  Permanently activate or deactivate the function.

Gearshift recommendation

The gearshift recommendation assists you in adopting an economical driving style.



-  When gearshift recommendation  appears on the driver's display, shift to the recommended gear.

Using kickdown

-  **Maximum acceleration:** depress the accelerator pedal beyond the point of resistance.

To protect against engine overrev, the automatic transmission will shift up to the next gear when maximum engine speed has been reached.

Glide mode function

NOTE Mercedes-AMG vehicles

-  Observe the notes in the Supplement. You could otherwise fail to recognize dangers.

Glide mode helps you to reduce fuel consumption when you employ an anticipatory driving style.

Glide mode is characterized by the following:

- The internal-combustion engine is switched off depending on the driving situation. All the vehicle functions remain active.
- The transmission position display  is shown in green.

Glide mode is activated if the following conditions are met:

- Drive program  is selected.
- The speed is within a suitable range.
- The road's course is suitable, e.g. no steep inclines or tight bends.
- The state of charge of the battery is sufficient.

- You do not depress the accelerator or brake pedal (except for light brake applications).
- i** Glide mode can also be activated if you have selected the "Eco" setting for the drive in the drive program .

Glide mode will be deactivated again if one of the conditions is no longer met.

Glide mode can also be prevented by the following parameters:

- Incline
- Downhill gradient
- Temperature
- Altitude
- Speed
- Operating condition of the engine
- Traffic situation

Function of 4MATIC

4MATIC ensures that all four wheels are driven. Together with ESP® and 4ETS, 4MATIC improves

the traction of your vehicle whenever a driven wheel spins due to insufficient traction.

If you fail to adapt your driving style, 4MATIC can neither reduce the risk of an accident nor override the laws of physics. 4MATIC cannot take account of road, weather and traffic conditions. 4MATIC is only an aid. You are responsible in particular for maintaining a safe distance from the vehicle in front, for vehicle speed, for braking in good time and for staying in lane.

- i** In wintry road conditions, the maximum effect of 4MATIC can be achieved only if you use winter tires (M+S tires), with snow chains if necessary.

Refueling

Refueling the vehicle

⚠ WARNING Risk of fire or explosion from fuel

Fuels are highly flammable.

- ▶ Fire, open flames, smoking and creating sparks must be avoided.
- ▶ Before refueling, switch off the vehicle and, if installed, the stationary heater, and leave them switched off during refueling.

⚠ WARNING Risk of injury from fuels

Fuels are poisonous and hazardous to your health.

- ▶ Do not swallow fuel or let it come into contact with skin, eyes or clothing.
- ▶ Do not inhale fuel vapor.
- ▶ Keep children away from fuel.
- ▶ Keep doors and windows closed during the refueling process.

If you or other people come into contact with fuel, observe the following:

- ▶ Immediately rinse fuel off your skin with soap and water.

- ▶ If fuel comes into contact with your eyes, immediately rinse them thoroughly with clean water. Seek medical attention immediately.
- ▶ If you swallow fuel, seek medical attention immediately. Do not induce vomiting.
- ▶ Change immediately out of clothing that has come into contact with fuel.

⚠ WARNING Risk of fire and explosion due to electrostatic charge

Electrostatic charge can ignite fuel vapor.

- ▶ Before you open the fuel filler cap or take hold of the pump nozzle, touch the metallic vehicle body.
- ▶ To avoid creating another electrostatic charge, do not get into the vehicle again during the refueling process.

! NOTE Damage caused by the wrong fuel

Vehicles with a gasoline engine:

Even small amounts of the wrong fuel could result in damage to the fuel system, the engine and the emission control system.

- ▶ Refuel only with low-sulfur spark-ignition engine fuel.

This fuel may contain up to 10% ethanol. Your vehicle is suitable for use with E10 fuel.

Never refuel with any of the following fuels:

- Diesel
- Gasoline with more than 10% ethanol by volume, e.g. E15, E85, E100
- Gasoline with more than 3% methanol by volume, e.g. M15, M30, M85, M100
- Gasoline with metallic additives

If you have accidentally refueled with the wrong fuel:

- ▶ Do not switch on the vehicle.
- ▶ Consult a qualified specialist workshop.

! NOTE Do not use diesel to refuel vehicles with a gasoline engine

If you have accidentally refueled with the wrong fuel:

- Do not switch on the vehicle. Otherwise fuel can enter the engine.

Even small amounts of the wrong fuel could result in damage to the fuel system and the engine. The repair costs are high.

- ▶ Consult a qualified specialist workshop.
- ▶ Have the fuel tank and fuel lines drained completely.

! NOTE Damage to the fuel system due to overfilling the fuel tank

- ▶ Only fill the fuel tank until the pump nozzle switches off.

If too much fuel has been added due, for example, to a faulty filling pump:

- ▶ Do not switch on the vehicle.

▶ Consult a qualified specialist workshop.

1 NOTE Fuel may spray out when you remove the fuel pump nozzle

▶ Only fill the fuel tank until the pump nozzle switches off.

Requirements:

- The vehicle is unlocked.
- **Plug-in hybrid with gasoline engine:** the fuel tank was vented before refueling (→ page 204).

Observe the notes on operating fluids and fuel.

Refuel only using fuel that has at least the octane number specified in the information label on the inside of the fuel filler flap. Otherwise, engine output may be reduced and fuel consumption increased.

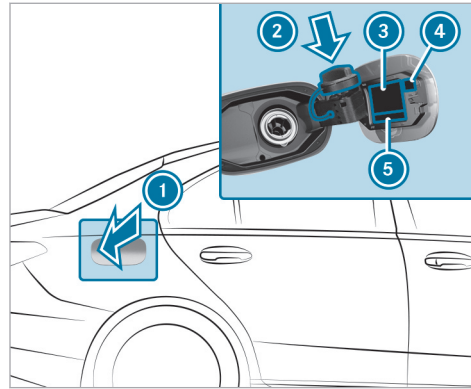

- ① Fuel filler flap
- ② Bracket for the fuel filler cap
- ③ Tire pressure table
- ④ QR code for rescue card
- ⑤ Fuel type

i Plug-in hybrid with gasoline engine: the fuel filler flap will open automatically after the fuel tank has been vented (→ page 204).

- ▶ Press on the center rear of the fuel filler flap ①.
- ▶ Turn the fuel filler cap counter-clockwise and remove it.
- ▶ Insert fuel filler cap from above into bracket ②.
- ▶ Completely insert the pump nozzle into the tank filler neck, hook in place and refuel.
- ▶ Fill the fuel tank only until the pump nozzle switches off.
- ▶ Replace the fuel filler cap on the tank filler neck and turn clockwise until it engages audibly.
- ▶ Close fuel filler flap ①.

Depressurize the fuel tank (plug-in hybrid with gasoline engine)

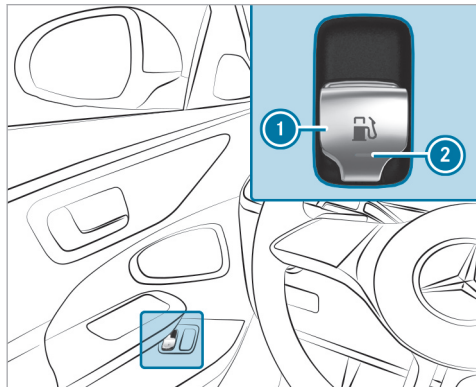

- ▶ Pull switch ① once briefly. Indicator lamp ② will flash and the **Please Wait Depressurizing Fuel Tank** message will appear on the driver display.

When the fuel tank is depressurized, the indicator lamp ② lights up continuously.

The **Fuel Tank Is Depressurized Ready for Refueling** message will appear on the driver display and the fuel filler flap will open automatically.

- ① Depressurizing the fuel tank may take several minutes.

The fuel tank can be depressurized only if the conditions described above are met. Otherwise, drive the vehicle at least 1/3 mile (0.5 km) and repeat the process.

- ① In the following situations, there is a malfunction:
 - Indicator lamp ② flashes initially and then goes out.
 - The yellow  engine diagnostics warning lamp lights up.

! **NOTE** Damage to the fuel filler flap when opening it

If an attempt is made to open a fuel filler flap that is not unlocked, the fuel filler flap or the opening mechanism may be damaged.

- ▶ Only refuel when the fuel filler flap has opened automatically.

Charging the high-voltage battery (plug-in hybrid)

Notes on charging the high-voltage battery

- !** **NOTE** High-voltage battery damage due to leaving the vehicle idle for lengthy periods of time

Lithium-ion batteries experience a natural self-discharge.

Exhaustive discharging can therefore occur if the vehicle is idle for several months. This can damage the high-voltage battery.

- ▶ To avoid damage, please observe the following recommendations when handling the high-voltage battery.

! **NOTE** Accelerated aging of the high-voltage battery due to not observing the following recommendations

As a result of its basic characteristics, the storage capacity of and the amount of energy available from the high-voltage battery decreases over the course of its life. Due to this, both the maximum electrical range that can be achieved by the vehicle and its maximum electrical output can be impaired.

The following factors could accelerate the aging of the high-voltage battery:

- A high condition of charge, especially if the vehicle is idle for a lengthy period of time
- Frequent rapid charging with direct current (mode 4)
- Leaving the vehicle idle for lengthy periods at high ambient temperatures

▶ To avoid accelerated aging, please observe the following recommendations when handling the high-voltage battery.

! **NOTE** Damage to the drive system when the high-voltage battery is charged at extreme altitudes

The drive system may be damaged if you charge the high-voltage battery at extreme altitudes more than 13123.36 ft (4000 m) above sea level.

Continuing the journey may then no longer be possible.

▶ Avoid charging processes at extreme altitudes.

Recommendations when handling the high-voltage battery:

- Rapid-charge the high-voltage battery with direct current (Mode 4) only when required.
- In case of longer idle times, switch off the vehicle with a state of charge of the high-voltage battery between 25 % and 30 %. Do not permanently connect the high-voltage battery to a power supply.

- If leaving the vehicle idle for lengthy periods, avoid high outside temperatures wherever possible.
- Check the high-voltage battery's state of charge every six weeks (→ page 219).
- Make sure to charge the high-voltage battery if the state of charge is below 15 %.
- Do not disconnect the 12 V battery even if the vehicle is left unused for a lengthy period. Otherwise the condition of the vehicle's high-voltage battery cannot be monitored.
- When only using the high-voltage battery with low states of charge, fully charge the high-voltage battery twice a year.

Depending on the equipment, your vehicle is equipped with one of the following vehicle sockets:

- Type 1 for charging with alternating current (mode 2/3)
- Type Combo 1 for charging with alternating current (mode 2/3) and charging with direct current (mode 4)

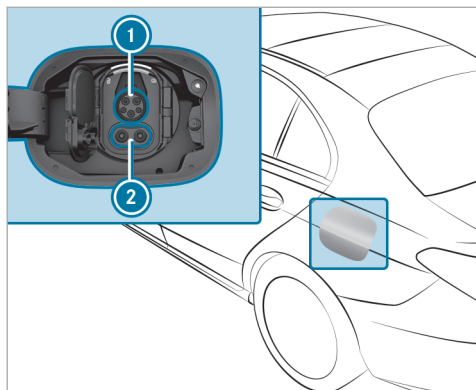

Example: type Combo 1 vehicle socket

- ① AC charging port
- ② Socket extension for DC charging
- i When using a CCS charging cable (Combined Charging System) for charging with direct current, both areas of the vehicle socket are covered by the charging cable plug.

Charging options for the high-voltage battery (mode 2, 3 or 4):

- while on the move, through recuperation
- Stationary AC charging:
 - at a mains socket (mode 2)
 - at a wallbox or charging station (mode 3)
- Stationary DC charging:
 - At a rapid-charging station (mode 4)

Depending on the country-specific vehicle equipment and your vehicle's charging cable, single phase AC charging is also possible.

Observe the different mains requirements of your current location when charging. Only use charging cables which conform to the mains requirements. Consult a qualified electrician or your local mains operator if you have any questions.

It is recommended that you charge the high-voltage battery at a wallbox or charging station due to the improved charging power and better charging efficiency offered.

System limits

The power of the high-voltage battery may be impaired by the following:

- high or low outside temperatures
- electrical auxiliary consumers in the vehicle being switched on, e.g. operating the air conditioning system
- extended idle periods without charging

The charging time or the charging power of the high-voltage battery may be increased by the following:

- high or low outside temperatures
- a low or high state of charge of the high-voltage battery
- the maximum available charge current of the charging device

Stowing the charging cable

Always stow the vehicle's charging cable in the charging cable bag provided, and secure the charging cable bag in the trunk or load compart-

ment with the included retaining strap. Otherwise, the charging cable bag with the charging cable is not sufficiently secured.



Example: charging cable bag in the trunk/load compartment

As delivered, charging cable bag ① with retaining strap ② is located in the trunk or load compartment. To secure the charging cable bag, the

retaining strap must be attached to tie-down eye ③. Do not use bag hooks to attach the retaining strap.

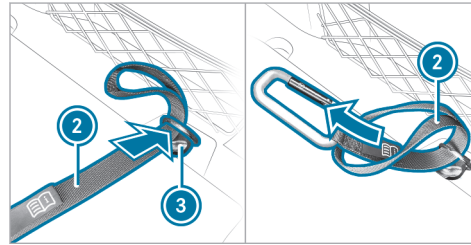

- ▶ Feed the loop end of retaining strap ② through tie-down eye ③ in the trunk or load compartment.
- ▶ Feed the end with the snap hook through the loop of retaining strap ②.



- ▶ Tighten retaining strap ② so that the knot around tie-down eye ③ is tight and secure.
- ▶ Hook the snap hook of retaining strap ② in a tie-down eye of charging cable bag ①.

Notes on charging the high-voltage battery at a mains socket (Mode 2)

⚠ DANGER Risk of fatal injury from incorrectly installed component parts

Connecting the charging cable to a mains socket using incorrectly installed component parts could cause a fire or an electric shock, for example.

- ▶ Only connect the charging cable to a mains socket that:
 - has been properly installed and
 - has been inspected by a qualified electrician
- ▶ For safety reasons, only use the charging cable supplied with the vehicle or an original Mercedes-Benz charging cable.
- ▶ Purchase these parts at an authorized Mercedes-Benz Center and obtain advice there.

Mercedes-Benz thoroughly tests these original charging cables for their suitability for high-voltage charging of your vehicle.

- ▶ Never use a damaged charging cable.
- ▶ Do not use:
 - extension cables
 - extension reels
 - multiple sockets
- ▶ Never use socket adapters to connect the charging cable to the mains socket. The only exception being if the adapter has been tested and approved by the manufacturer for charging the high-voltage battery of an electric vehicle.
- ▶ Observe the safety notes in the operating instructions for the socket adapter.

Only the following charging cables may be used:

- The charging cable supplied with the vehicle.
- A charging cable that has been approved for the vehicle.

The charging process can vary depending on the power supply equipment. The charging times when charging the high-voltage battery at the mains socket are considerably longer than when charging at a wallbox or charging station.

When doing so, always observe the local information.

Do not leave the charging cable controls hanging loose from a mains socket.

Do not lift the controls by the following component parts:

- the charging cable connector
- the mains plug

When charging, protect the charging cable control element from excessive heat such as direct sunlight. Otherwise the charging process may be aborted.

Notes on charging the high-voltage battery at a wallbox or charging station (mode 3)

⚠ DANGER Risk of fatal injury from incorrectly installed component parts

Connecting the charging cable to the vehicle using incorrectly installed components could cause a fire or an electric shock, for example.

- ▶ Only connect the charging cable to a wallbox if:
 - The wallbox has been properly installed
 - The wallbox has been inspected by a qualified electrician
 - The charging cable is not damaged
- ▶ Do not extend the charging cable.
- ▶ Do not use adapters.
- ▶ Observe the safety notes in the operating instructions for the wallbox.

⚠ DANGER Risk of fatal injury if damaged component parts are used

If you use a damaged component part to connect the vehicle to a charging station, this may lead to e.g. a fire or electrocution.

- ▶ Visually inspect the charging station for obvious signs of damage, e.g. serious damage to the housing or charging cable connection.
- ▶ Never use damaged charging cables.
- ▶ Do not extend the charging cable.
- ▶ Do not use adapters. The only exception is if the adapter has been tested and approved for your vehicle by Mercedes-Benz.
- ▶ Be sure to observe the safety instructions on the charging station.

Most charging stations must be activated before the charging process, e.g. using an RFID card or via Plug-and-Charge. Observe the operator's on-site instructions for the charging station and the

notes on Mercedes me Charge (see the vehicle's Digital Operator's Manual).

The amount of energy dispensed for the charging process, shown by the charging station, may be higher than the amount of energy actually absorbed by the high-voltage battery. This is the result of different levels of charging losses and is described as recharge efficiency. Charging losses occur, e.g. owing to heat build-up when the vehicle is charging or from auxiliary consumers that are switched on. Further information on recharge efficiency can be obtained at a qualified specialist workshop.

Notes on charging the high-voltage battery at a quick charging station (mode 4)

⚠ DANGER Risk of fatal injury if damaged component parts are used

If you use a damaged component part to connect the vehicle to a charging station, this may lead to e.g. a fire or electrocution.

- ▶ Visually inspect the charging station for obvious signs of damage, e.g. serious

damage to the housing or charging cable connection.

- ▶ Never use damaged charging cables.
- ▶ Do not extend the charging cable.
- ▶ Do not use adapters. The only exception is if the adapter has been tested and approved for your vehicle by Mercedes-Benz.
- ▶ Be sure to observe the safety instructions on the charging station.

⚠ DANGER Risk of fatal injuries when carrying out maintenance work during the charging process

During the charging process, the high-voltage on-board electrical system is under high voltage.

- ▶ Do not perform any maintenance work during the charging process.

Most charging stations must be activated before the charging process, e.g. using an RFID card or via Plug-and-Charge. Observe the operator's on-

site instructions for the charging station and the notes on Mercedes me Charge (see the vehicle's Digital Operator's Manual).

The amount of energy dispensed for the charging process, shown by the charging station, may be higher than the amount of energy actually absorbed by the high-voltage battery. This is the result of different levels of charging losses and is described as recharge efficiency. Charging losses occur, e.g. owing to heat build-up when the vehicle is charging or from auxiliary consumers that are switched on. Further information on recharge efficiency can be obtained at a qualified specialist workshop.

Maximum permissible charging current for charging at a mains socket

The charging cable supplied is set to a country-specific maximum charging current value. When charging abroad, the maximum value may exceed the permitted value for that country.

- ▶ Before charging at a mains socket, have the maximum permissible charging current for the

relevant mains socket or the building checked by a qualified electrician.

- ▶ When abroad, observe the country-specific laws when charging.

If you have questions concerning the charging current or if there is a malfunction, please contact a qualified specialist workshop.

Overview of the charging cable control panel

Your vehicle may be equipped with one of the following two mode 2 charging cables. The control panel of the respective mode 2 charging cable shows the current status of the charging process.

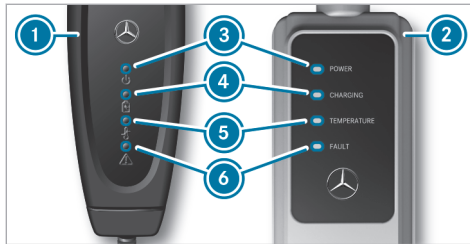

- ① Gen5 charging cable
- ② Gen4 charging cable
- ③ Supply voltage indicator
- ④ Charging process display
- ⑤ Temperature monitor display
- ⑥ Safety system display

Mains current display ③ POWER

Display	Meaning
Lights up white	Supply voltage is present.

Charging process display ④ CHARGING

Display	Meaning
Flashes green	The high-voltage battery is charging.

Temperature monitor display ⑤ TEMPERATURE

Display	Meaning
Lights up red	The green LED flashes simultaneously: over-temperature – the charging power is reduced. The green LED does not flash: over-temperature – the charging process has finished.
Flashes red	Overtemperature at the mains plug – the charging process is stopped.

Safety system display ⑥ malfunction

Display	Meaning
Flashes red	Charging cable or internal malfunction – Charging not possible Reset charging cable control panel (Gen5 charging cable ①)
Lights up red (Gen5 charging cable ①)	White LED is off: power supply malfunction – charging process not possible – use a different mains socket. White LED is on: vehicle malfunction – charging process not possible, reset the charging cable control panel.

Display	Meaning
Lights up red (Gen4 charging cable ②)	Infrastructure malfunction – Charging process not possible, use a different mains socket

If the temperature monitor ⑤ indicates a malfunction, it may help to protect the charging cable from direct sunlight.

Gen4 charging cable ②

If the charging cable control panel detects residual current or a malfunction, the charging process is interrupted. The charging process is resumed automatically when the malfunction has been rectified.

Gen5 charging cable ①

If all four displays light up, the charging cable control panel is performing a self-test.

Reset the Gen5 charging cable control panel: if the safety system ⑥ indicates a charging cable malfunction or a vehicle malfunction, first reset the charging cable control panel. To do this, dis-

connect the charging cable from the vehicle and from the mains socket and wait for approximately five seconds. If the malfunction persists after the charging cable is reconnected, charging at the mains socket is not possible. The charging cable must be replaced or the vehicle plug must be checked at a qualified specialist workshop, depending on the readout.

Functions of the indicator lamps on the vehicle socket

The socket flap is centrally locked and unlocked together with the vehicle.

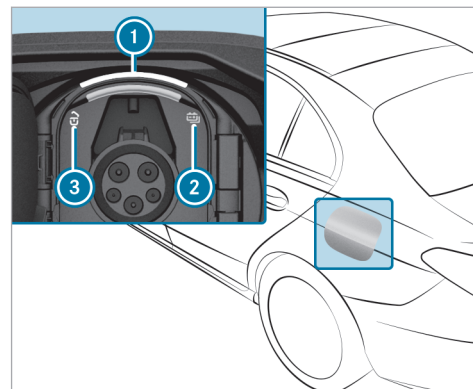

Example: type Combo 1 vehicle socket

- ① Socket lamp
- ② Charging process indicator lamp
- ③ Locking status indicator lamp

The upper curve of the socket lamp ① is used for the lighting and flashes or lights up as with indicator lamp ③. The lower curve is used for the sta-

tus display and flashes or lights up as with indicator lamp ②.

The color and behavior of the indicator lamps ② and ③ have the following meaning.

Locking status  ③

- Lights up white: vehicle socket unlocked; insert or remove charging cable
- Flashes white: malfunction during locking or unlocking

Status of the charging process  ②

- Lights up green (for approx. 60 s): charging process completed
- Flashes green: charging; active energy flow
- Lights up orange (for approx. 60 s): charging break
- Flashes orange: connection is being established
- Flashes red (for approx. 90 s): malfunction in vehicle; charging not possible

Starting the alternating current charging process (mode 2/3)

⚠ DANGER Risk of death when charging at a damaged socket

The charging process uses high voltage.

If the charging cable, the vehicle socket or the mains socket are damaged, you could receive an electric shock.

- ▶ Only use an undamaged charging cable.
- ▶ Avoid mechanical damage such as crushing, abrading or driving over the cable.
- ▶ Have a damaged vehicle socket replaced at a qualified specialist workshop as soon as possible.
- ▶ Never connect the charging cable to a damaged vehicle socket.

! **NOTE** Damage due to overheating of charging cable and charge port

Charging cable and charge port may generate heat within the permissible limiting values during the charging process.

The heat generated by the charging cable and charge port is influenced by the following factors:

- The power supply of the mains and the charging cable are intact.
- The notes on handling the charging cable and operating unit on the charging cable were observed.
- ▶ If the charging cable or the charge port generate too much heat, have the power supply of the mains supply checked.

! **NOTE** Damaged or dirty vehicle socket when the socket flap is open

- ▶ Always keep the socket cover and the socket flap closed when there is no

charging cable connected. This protects the vehicle socket from dirt and damage.

- ▶ Make sure that the socket cover is closed properly before closing the socket flap. This can otherwise result in damage which may prevent the socket flap from being opened again.

! **NOTE** Damage to the vehicle socket or the charging cable connector due to incorrect handling

Do not use excessive force (maximum 67.4 lbf (300 N)) to fully insert the charging cable connector into the vehicle socket. You may otherwise damage the vehicle socket, the charging cable connector or their contacts.

- ▶ If you feel there is increased resistance, pull the charging cable connector out of the socket and reinsert it.

Requirements

- The transmission is in position **P**.

- The vehicle is unlocked or the vehicle is locked and the distance between the key and the vehicle does not exceed 3 ft (1 m).
- The charging cable is not under tension.

Depending on the equipment, your vehicle is equipped with one of the following vehicle sockets:

- Type 1 for AC charging (mode 2/3)
- Type Combo 1 for AC charging (mode 2/3) and DC charging (mode 4)

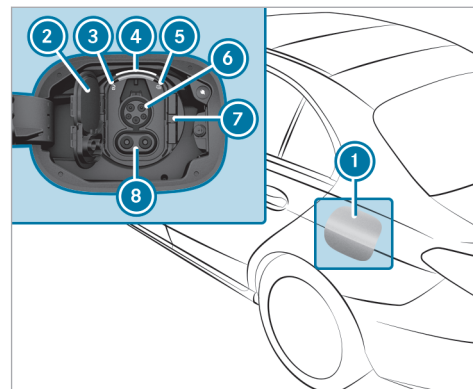

Example: type Combo 1 vehicle socket

- ▶ Press the rear center area of the socket flap **1** and swivel the socket flap outwards. The indicator lamp **3** and upper status display **4** light up white.

- i** The socket flap **1** can also be opened via the multimedia system (→ page 329).

If the socket flap ① cannot be opened despite the vehicle being unlocked, the socket flap can be opened by emergency release (→ page 219).

▶ Press catch ⑦ to the right and open the socket cover ②.

ⓘ On vehicles with a Combo vehicle socket, only the connection ⑥ is required for the charging cable connector. Only open the upper part of the socket cover ②.

▶ For charging at a mains socket insert the mains plug into the mains socket of the external power source to the stop.

▶ Fully insert the charging cable connector into vehicle socket ⑥. If the wallbox/charging station is not equipped with a charging cable, insert the plug of the vehicle's charging cable into the wallbox/charging station socket right to the stop.
Make sure that the inserted charging cable is not under tension.

The indicator lamp ⑤  and lower status display ④ flash orange, and green as soon as the high-voltage battery is charged.

When the charging cable is connected to the vehicle, the vehicle cannot be started or moved.

At the start of the charging process, the charge level display is shown on the driver display with a charging prediction. The charging prediction is the point in time at which the high-voltage battery will be fully charged.

- ⓘ Depending on the temperature, the fan and battery cooling system may audibly switch on during the charging process.
- ⓘ If the vehicle is idle for long periods and connected to the mains supply, the high-voltage battery will be recharged automatically as needed or when electrical consumers are activated (e.g. pre-entry climate control).
- ⓘ The vehicle is equipped with an electric fuse that protects against overvoltages in the mains supply. This electric fuse can be triggered e.g. in severe storms and result in tripping the fuse in the building and in an inter-

ruption of charging. These functions protect the vehicle.

After the building's circuit breaker is switched on again, the charging process resumes automatically. Following an interruption in the power supply without the building's circuit breaker being tripped, it may take up to ten minutes for charging to resume automatically.

Ending the alternating current charging process (mode 2/3)

Requirements

- The vehicle is unlocked or the vehicle is locked and the distance between the key and the vehicle does not exceed 3 ft (1 m).

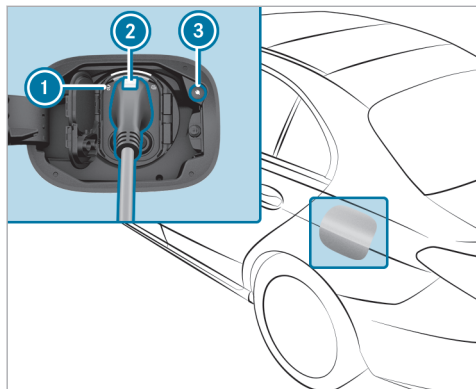

Example: type Combo 1 vehicle socket

- ❶ Vehicles equipped only with a Type 1 vehicle socket for AC charging have no charging interruption button ❸.

▶ **Type Combo 1 vehicle socket:** press the charging interruption button ❸.

The charging process is ended. The  indicator lamp ❶ lights up white. The vehicle socket is unlocked.

- ❶ As an alternative, and only if the charging interruption button ❸ is not working, you can unlock the vehicle using the vehicle key or centrally from inside to end the charging process. If the indicator lamp  ❶ then lights up white, the vehicle socket is unlocked for around 30 seconds.

- ❶ The charging process can also be ended via the multimedia system (→ page 329).

▶ **Type 1 vehicle socket:** unlock the vehicle with the vehicle key or centrally from inside.

The charging process is ended. The  indicator lamp ❶ lights up white. The vehicle socket is unlocked.

- ▶ Press and hold button ❷ on the charging cable connector and remove the charging cable connector from the vehicle socket.

- ❶ If you cannot remove the charging cable plug, repeat the unlocking procedure. If the charging cable plug is still locked, contact a qualified specialist workshop.

- ▶ Close the socket cover and the socket flap.

- ❶ The indicator lamp  ❶ on the vehicle socket remains lit for some time after the charging cable plug has been disconnected and then goes out.

Starting the direct current charging process (mode 4)

⚠ DANGER Risk of death when charging at a damaged socket

The charging process uses high voltage.

If the charging cable, the vehicle socket or the mains socket are damaged, you could receive an electric shock.

- ▶ Only use an undamaged charging cable.
- ▶ Avoid mechanical damage such as crushing, abrading or driving over the cable.

- ▶ Have a damaged vehicle socket replaced at a qualified specialist workshop as soon as possible.
- ▶ Never connect the charging cable to a damaged vehicle socket.

! **NOTE** Damage due to overheating of charging cable and charge port

Charging cable and charge port may generate heat within the permissible limiting values during the charging process.

The heat generated by the charging cable and charge port is influenced by the following factors:

- The power supply of the mains and the charging cable are intact.
- The notes on handling the charging cable and operating unit on the charging cable were observed.
- ▶ If the charging cable or the charge port generate too much heat, have the power supply of the mains supply checked.

! **NOTE** Damaged or dirty vehicle socket when the socket flap is open

- ▶ Always keep the socket cover and the socket flap closed when there is no charging cable connected. This protects the vehicle socket from dirt and damage.
- ▶ Make sure that the socket cover is closed properly before closing the socket flap. This can otherwise result in damage which may prevent the socket flap from being opened again.

! **NOTE** Damage to the vehicle socket or the charging cable connector due to incorrect handling

Do not use excessive force (maximum 67.4 lbf (300 N)) to fully insert the charging cable connector into the vehicle socket. You may otherwise damage the vehicle socket, the charging cable connector or their contacts.

- ▶ If you feel there is increased resistance, pull the charging cable connector out of the socket and reinsert it.

Requirements

- The transmission is in position **P**.
- The vehicle is unlocked or the vehicle is locked and the distance between the key and the vehicle does not exceed 3 ft (1 m).
- The charging cable is not under tension.

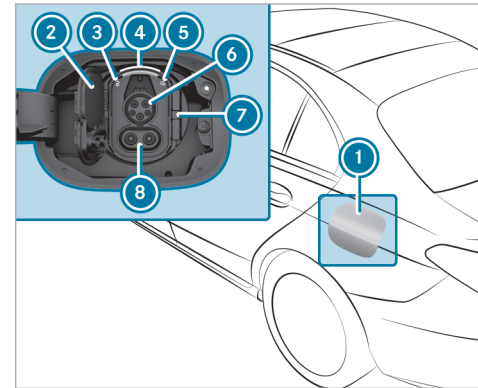

▶ Press the center rear of the socket flap ① and fold the socket flap forwards. The indicator lamp ③  and upper status display ④ light up white.

① The socket flap ① can also be opened via the multimedia system (→ page 329). If the socket flap ① cannot be opened despite the vehicle being unlocked, the socket flap can be opened by emergency release (→ page 219).

▶ Press catch ⑦ to the right and open the socket cover ②.

① Connections ⑥ and ⑧ are required for the CCS charging cable plug. Both sections of the socket cover must therefore be opened ②.

▶ Fully insert the CCS charging cable plug into the vehicle socket. Make sure that the charging cable is not under tension when inserted.

The indicator lamp ⑤  and lower status display ④ flash orange, and green as soon as the high-voltage battery is charged.

When the charging cable is connected to the vehicle, the vehicle cannot be started or moved.

At the start of the charging process, the state of charge indicator is shown on the driver display with a charging prediction. The completion time either refers to the predicted state of charge at the set departure time, or the time at which the high-voltage battery will be fully charged.

- ① Depending on the temperature, the fan and battery cooling system may audibly switch on during the charging process.
- ① If the vehicle is idle for lengthy periods and connected to the mains supply, the high-voltage battery will be recharged automatically as needed or when electrical consumers are activated (e.g. pre-entry climate control).



Ending the direct current charging process (mode 4)

Requirements

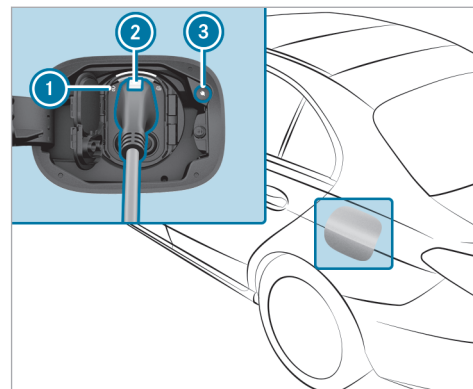
- The vehicle must be unlocked or locked and the distance between the key and the vehicle must not exceed 3 ft (1 m).



▶ Press the charging interruption button ③. The charging process ends. The  indicator lamp ① lights up white. The vehicle socket is unlocked.

- i** As an alternative, and only if the charging interruption button **3** is not working, you can unlock the vehicle using the vehicle key or centrally from inside to end the charging process. If the indicator lamp  **1** then lights up white, the vehicle socket is unlocked for around 30 seconds.
- i** The charging process can also be ended via the multimedia system (→ page 329).
- ▶** Press and hold button **2** on the charging cable plug and remove the charging cable plug from the vehicle socket.
- i** If you cannot remove the charging cable plug, unlock the vehicle and repeat the unlocking procedure. If the charging cable plug is still locked, contact a qualified specialist workshop.
- ▶** Close the socket cover and the socket flap.
- i** The left-hand indicator lamp  **1** on the vehicle socket remains lit for some time after the charging cable plug has been disconnected and then goes out.

Emergency release of the socket flap

If the socket flap cannot be opened due to a malfunction, an emergency release of the socket flap can be performed for the charging process.

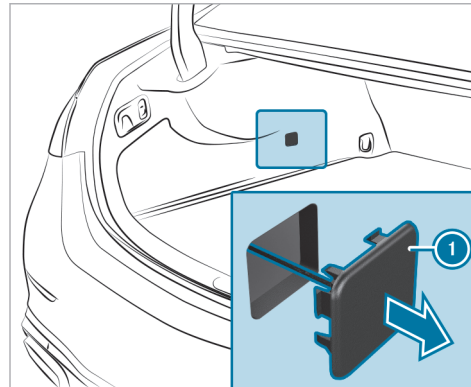

- ▶** Pull emergency release **1** in the direction of the arrow. The socket flap of the vehicle socket swings open.

- ▶** Start the alternating current charging process (→ page 213).
- or
- ▶** Start the direct current charging process (→ page 216).

Function of the charge level display in the driver display

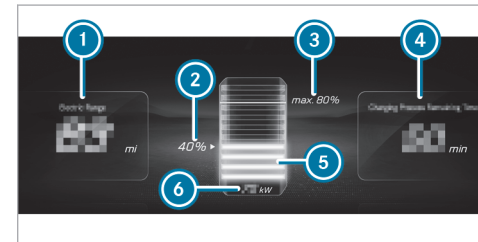

- 1** Remaining range at current state of charge
- 2** Current state of charge of the high-voltage battery
- 3** Maximum state of charge (as per the setting)

- ④ Remaining time until fully charged (up to the selected maximum state of charge)
- ⑤ Dynamic charge level display
- ⑥ Current charging power
- ⓘ The indicated remaining range ① may vary due to various factors, e.g. driving style or topography.

When the vehicle is switched off and connected to the mains supply, the driver display shows the charge level display for approximately two minutes.

- ⓘ The value of current charging power ⑥ can differ from the display on the charging station.

Mercedes-AMG vehicles: the prediction for the remaining range ① and the maximum state of charge ③ are not displayed.

Parking

Parking the vehicle

- ⚠ **WARNING** Risk of accident and injury caused by an insufficiently secured vehicle rolling away

If the vehicle is not securely parked sufficiently, it can roll away in an uncontrolled way even at a slight downhill gradient.

- ▶ On uphill or downhill gradients, turn the front wheels so that the vehicle rolls towards the curb if it starts moving.
- ▶ Apply the parking brake.
- ▶ Switch the transmission to position **P**.

- ⚠ **WARNING** Risk of fire caused by hot exhaust system parts

Flammable materials such as leaves, grass or twigs may ignite.

- ▶ Park the vehicle so that no flammable material can come into contact with hot vehicle components.

- ▶ In particular, do not park on dry grassland or harvested grain fields.

- ⚠ **WARNING** Risk of accident and injury due to children left unattended in the vehicle

If you leave children unattended in the vehicle, they could, in particular:

- open doors, thereby endangering other persons or road users.
- get out and be struck by oncoming traffic.
- operate vehicle equipment and become trapped, for example.

In addition, the children could also set the vehicle in motion by, for example:

- releasing the parking brake.
- changing the gearbox position.
- starting the vehicle.

- ▶ Never leave children unattended in the vehicle.

- ▶ When leaving the vehicle, always take the key with you and lock the vehicle.
- ▶ Keep the key out of reach of children.

This also applies to the Digital Vehicle Key.

! **NOTE** Damage to the vehicle due to it rolling away

- ▶ Always secure the vehicle against rolling away.

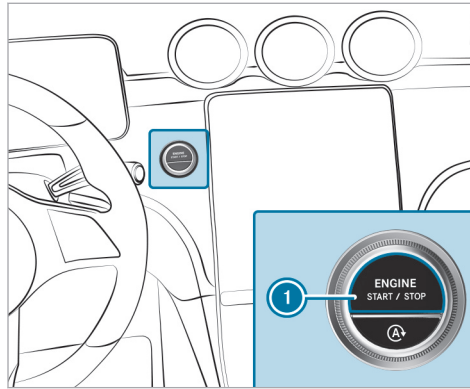

- ▶ Bring the vehicle to a standstill by depressing the brake pedal.
- ▶ On inclines, turn the front wheels so that the vehicle will roll towards the curb if it starts moving.
- ▶ Apply the electric parking brake.

- ▶ Engage transmission position **P** when the vehicle is stationary and the brake pedal is depressed (→ page 198).
 - ▶ Switch off the vehicle by pressing button **1**.
 - ▶ Release the service brake slowly.
 - ▶ Get out of the vehicle and lock it.
- i** When you park the vehicle, you can still operate the side windows and the sliding sunroof for approximately four minutes if the driver's door is closed.
- i** When you park the vehicle, you can still operate the side windows and the panoramic sliding sunroof for approximately four minutes if the driver's door is closed.

Automatic vehicle shut-off upon locking

Your vehicle is equipped with automatic engine shut-off.

When you leave the vehicle ready to drive, the vehicle will be turned off when locked under the following conditions:

- The ignition is switched on or the engine is running.

- Transmission position **P** is engaged.
- The driver's door is closed.
- **In addition, one of the following conditions must be fulfilled:**
 - The vehicle is locked using the vehicle key.
 - **Vehicles with KEYLESS-GO:** the vehicle is locked via KEYLESS-GO on the door handle of a closed door.
 - **Vehicles with KEYLESS-GO:** the vehicle is locked via the locking button on the trunk lid.

i The engine will continue to run if the vehicle is not locked as described after you have left it. In this case, switch off the vehicle manually.

Automatic vehicle shut-off after a period of time (equipment-dependent)

When the engine is running, the following display message will appear on the driver display when you leave the vehicle or after a certain holding time in transmission position **P** : [Vehicle Ready to Drive Shutdown Occurs When Locked or Automatically in XX Mins](#)

The vehicle will then switch off automatically after a total holding time of 20 minutes.

i To avoid automatic shut-off after a period of time, acknowledge the corresponding message on the central display of the multimedia system.

The engine will continue to run in the following cases:

- If the vehicle is not locked as described after you have left it
- If automatic shut-off is not indicated by the display message
- If automatic shut-off after a period of time has been deactivated via the corresponding message on the central display

In this case, switch off the vehicle manually.

Garage door opener

Programming buttons for the garage door opener

⚠ DANGER Risk of death caused by exhaust gases

Combustion engines emit poisonous exhaust gases such as carbon monoxide. Inhaling these exhaust gases is hazardous to health and leads to poisoning.

▶ Never leave the engine or, if present, the auxiliary heating running in an enclosed space without sufficient ventilation.

⚠ WARNING Risk of injury by becoming trapped when opening and closing a garage door

When you operate or program a garage door with an integrated garage door opener, persons can become trapped or struck by the garage door if they stand within its range of movement.

- ▶ Always make sure that nobody is within the range of the garage door's movement.

Operate only the following doors using the garage door opener:

- Doors with a safety stop and reversing function
- Doors that conform to the current US safety standards

Before programming the garage door opener, park the vehicle outside the garage. Make sure that the vehicle is switched on but not started.

Requirements

- The vehicle has been parked outside the garage or outside the range of movement of the door.
 - The vehicle is switched on.
 - The vehicle has not been started.
- i** The garage door opener function will always be available when the vehicle is switched on.

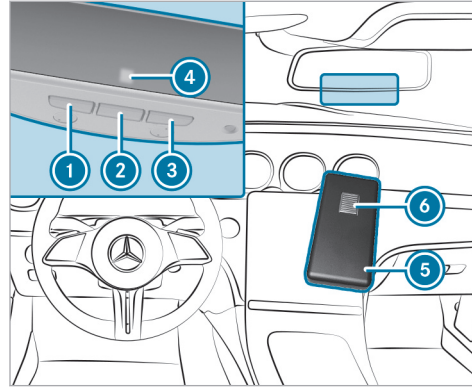

- ▶ Check whether the transmitter frequency of the remote control has the frequency range of 280 to 868 MHz.

Radio equipment approval number:

- NZLMUAHL5 (USA)
- 4112A-MUAHL5 (Canada)

- ▶ Press and hold button ①, ② or ③ that you wish to program. Indicator lamp ④ will flash yellow.

i It may take up to 20 seconds before the indicator lamp flashes yellow.

- ▶ Release the previously pressed button. Indicator lamp ④ will continue to flash yellow.

- ▶ Point the remote control ⑤ from a distance of between 0.4 in (1 cm) and 3 in (8 cm) towards button ①, ② or ③.

- ▶ Press and hold button ⑥ of remote control ⑤ until one of the following signals appears:
 - Indicator lamp ④ lights up green continuously. Programming is complete.
 - Indicator lamp ④ flashes green. Programming was successful. Additionally, the rolling code must be synchronized with the door system.

- ▶ If indicator lamp ④ does not light up or flash green: repeat the process.

- ▶ Release all the buttons.

- ❗ The remote control for the door drive is not included in the scope of delivery for the garage door opener.

■ Synchronizing the rolling code

Requirements

- The door system uses a rolling code.
 - The vehicle must be within range of the garage door or door drive.
 - The vehicle, as well as persons and objects are located outside the range of movement of the door.
- ▶ Press the programming button on the door drive unit. Initiate the next step within approximately 30 seconds.
 - ▶ Press the previously programmed button ①, ② or ③ repeatedly until the door closes. When the door closes, programming is completed.
- ❗ Please also read the operating instructions for the door drive.

■ Troubleshooting during programming of the remote control

- ▶ Check whether the transmitter frequency of the remote control ⑤ is supported.
 - ▶ Replace the batteries in the remote control ⑤.
 - ▶ Hold the remote control ⑤ at various angles in front of the inside mirror from a distance of between 0.4 in (1 cm) and 3 in (8 cm). You should test every position for at least 25 seconds before trying another position.
 - ▶ Hold remote control ⑤ at the same angles at various distances in front of the inside mirror. You should test every position for at least 25 seconds before trying another position.
 - ▶ Press the button ⑥ on the remote control ⑤ again before transmission ends on remote controls that transmit only for a limited period.
 - ▶ Angle the antenna line of the garage door opener unit towards the remote control.
- ❗ It is possible that older garage doors cannot be operated using the remote control in the inside mirror, even after you have successfully

performed the measures described above. In this case, contact the HomeLink® Hotline.

- ❗ Support and additional programming information:
 - from the toll-free HomeLink® Hotline on 1-800-355-3515
 - online at <https://www.homelink.com/mercedes>



■ Opening or closing the garage door

Requirements

- The corresponding button is programmed to operate the door.
- ▶ Press and hold buttons ①, ② or ③ until the door opens or closes.
 - ▶ If the indicator lamp ④ flashes yellow after approx. 20 seconds: Press the previously pressed button again and hold pressed until the door opens or closes.

■ Clearing the garage door opener memory

- ▶ Press and hold buttons ① and ③. Indicator lamp ④ lights up yellow.

- ▶ If indicator lamp  flashes green: release buttons  and .
- The entire memory has been deleted.

Electric parking brake

■ Function of the electric parking brake (applying automatically)

WARNING Risk of accident and injury due to children left unattended in the vehicle

If you leave children unattended in the vehicle, they could, in particular:

- open doors, thereby endangering other persons or road users.
- get out and be struck by oncoming traffic.
- operate vehicle equipment and become trapped, for example.

In addition, the children could also set the vehicle in motion by, for example:

- releasing the parking brake.

- changing the gearbox position.
 - starting the vehicle.
- ▶ Never leave children unattended in the vehicle.
- ▶ When leaving the vehicle, always take the key with you and lock the vehicle.
- ▶ Keep the key out of reach of children.

This also applies to the Digital Vehicle Key.



The electric parking brake is applied if the transmission is in position  and one of the following conditions is fulfilled:

- The vehicle is switched off.
 - The driver's seat belt is not fastened and the driver's door is opened.
-  To prevent application: pull the handle of the electric parking brake (→ page 226).

In the following situations, the electric parking brake is also applied:

- The HOLD function is keeping the vehicle stationary.

- Active Distance Assist DISTRONIC is bringing the vehicle to a standstill.
- Active Parking Assist is keeping the vehicle stationary.
- **In addition, one of the following conditions must be fulfilled:**
 - The vehicle is switched off.
 - The driver's seat belt is not fastened.
 - There is a system malfunction.
 - The power supply is insufficient.
 - The vehicle is stationary for a lengthy period.
- **Vehicles with Active Parking Assist:** In the following situations, the electric parking brake is also engaged:
 - Following completion of a parking procedure.
 - If an error occurs during a parking procedure.

When the electric parking brake is applied, the red indicator lamp lights up in the driver display  (USA) or  (Canada).

- ❗ The electric parking brake is not automatically applied if the vehicle is switched off by the ECO start/stop function.

Function of the electric parking brake (automatic release)

The electric parking brake is released when the following conditions are fulfilled:

- The driver's door is closed.
- The vehicle has been started.
- The transmission is in position **D** or **R** and you step on the accelerator pedal, or you shift from transmission position **P** to **D** or **R** on level ground.
- If the transmission is in position **R**, the trunk lid must be closed.
- The driver's seat belt is not properly fastened. If the driver's seat belt is not fastened, the following condition must be met:
 - You shift from transmission position **P**.

When the electric parking brake is released, the red **PARK** (USA) or **(P)** (Canada) indicator lamp in the driver display goes out.

Applying/releasing the electric parking brake manually

Apply

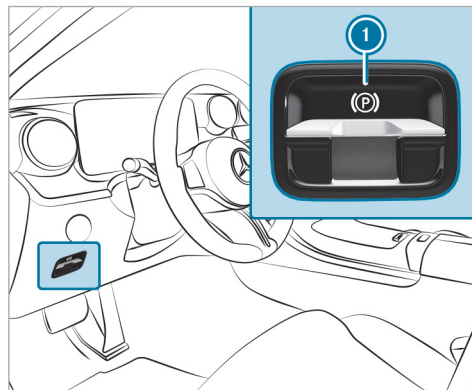

- ▶ Push handle ①. The red indicator lamp lights up on the driver display **PARK** (USA) or **(P)** (Canada).

- ❗ The electric parking brake is only securely applied if the red **PARK** (USA) or **(P)** (Canada) indicator lamp is lit continuously.

Release

- ▶ Switch on the vehicle.
- ▶ Pull handle ①. The red indicator lamp on the driver display goes out **PARK** (USA) or **(P)** (Canada).

Emergency braking

- ▶ Press and hold handle ①. As long as the vehicle is still in motion, the **Release Parking Brake** message is displayed and the red **PARK** (USA) or **(P)** (Canada) indicator lamp flashes.

When the vehicle has been braked to a standstill, the electric parking brake is applied. The red indicator lamp lights up on the driver display **PARK** (USA) or **(P)** (Canada).

Information on collision detection for a parked vehicle

Suppose a collision is detected on the locked vehicle when the tow-away alarm is switched on, and collision detection is switched on. In that case, when the vehicle is switched on, you will receive a message in the multimedia system.

You will receive information about the following points:

- The area of the vehicle that may have been damaged.
- The force of the impact.

The following situation can lead to inadvertent activation:

- For example, the parked vehicle is moved to a two-story garage.

i Deactivate the tow-away alarm to prevent inadvertent activation. If you deactivate the tow-away alarm, collision detection will also be deactivated.

You can permanently deactivate collision detection via the multimedia system (→ page 227).

- i** If the battery is heavily discharged, the function for detecting a collision on a parked vehicle is automatically deactivated to facilitate the next engine start.

System limits

Detection may be restricted in the following situations:

- the vehicle is damaged without impact, for example, if an outside mirror is torn off or the paint is damaged by a key
 - an impact occurs at low speed
 - the electric parking brake is not applied
- i** You are responsible for your vehicle. Convince yourself that your vehicle is free of damage and roadworthy.

Setting collision detection for a parked vehicle

Multimedia system:

 **Settings** **Vehicle**
Open/Close **Vehicle Protection**

▶ Activate or deactivate the function via **Collision Notification**.

- i** A maximum of three incidents can be registered. Up to 15 photos are taken for every incident. In the event of another incident, the photos of the first incident will be overwritten if they have not been deleted already.

Activating or deactivating the collision photos function

Please note that legal restrictions regarding automatic recording of the vehicle surroundings may be in place in certain countries.

▶ Activate or deactivate **Collision Photos**.

Transferring the collision photos with the Mercedes me app

▶ Select **Upload Collision Photos**.

▶ Select **Upload Automatically**.

▶ Scan the generated QR code on the central display with the Mercedes me app. The encrypted collision photos will then be uploaded to Mercedes me.

① Any device that can scan QR codes can be used to view the collision photos in the Mercedes me app.

Copying the collision photos to a USB flash drive

▶ Connect a USB flash drive .

▶ Select **Manage Collision Photos**.

▶ Select **Copy (USB)**.

All collision photos are copied to the USB flash drive.

① Use only FAT32- or exFAT-formatted USB storage devices to ensure secure operation.

Deleting collision photos

▶ Select **Manage Collision Photos**.

▶ Select **Delete**.

All collision photos are deleted.

Notes on parking the vehicle for an extended period

If you leave the vehicle parked for longer than six weeks, it may suffer damage through disuse.

The 12 V battery may also be impaired or damaged by heavy discharging.

① Further information can be obtained at a qualified specialist workshop.

Standby mode (extension of the starter battery's period out of use)

■ Standby mode function

① This function is not available for all models.

If standby mode is activated, energy loss will be minimized during extended periods of non-operation.

Standby mode is characterized by the following:

- The starter battery is preserved.
- The maximum non-operational time appears in the driver's display.

- The connection to online services is interrupted.

If the following conditions are fulfilled, standby mode can be activated or deactivated using the multimedia system:

- The vehicle is switched on.
- The vehicle has not been started.

Exceeding the vehicle's displayed non-operational time may cause inconvenience; i.e. it cannot be guaranteed that the starter battery will reliably start the vehicle.

Charge the starter battery in the following situations:

- The vehicle's non-operational time has to be extended.
- The starter battery charge level is insufficient for standby mode.

① Standby mode is automatically deactivated when the vehicle is switched on.

■ Activating/deactivating standby mode (parking the vehicle for a long period)

Requirements:

- The vehicle is switched on.
- The vehicle has not been started.

Multimedia system:

→  » Settings » Vehicle
 » Other Functions

▶ Activate or deactivate **Standby Mode**.

Driving and driving safety systems

Driving systems and your responsibility

Your vehicle is equipped with driving systems that assist you in driving, parking and maneuvering the vehicle. The driving systems are only aids. They are not a substitute for you paying attention to your surroundings and do not relieve you of your responsibility pertaining to road traffic law. The driver is always responsible for maintaining a safe distance to the vehicle in front, for vehicle speed, for braking in good time and for staying in lane.

Pay attention to the traffic conditions at all times and intervene when necessary. Be aware of the limitations regarding the safe use of these systems.

Driving systems can neither reduce the risk of an accident if you fail to adapt your driving style nor override the laws of physics. They cannot always take into account road, weather or traffic conditions.

-  Some driving systems can regulate or limit the speed to a previously set value. Draw attention to the stored speed when changing drivers.

Information on vehicle sensors and cameras

Some driving and driving safety systems use cameras as well as radar or ultrasonic sensors to monitor the area in front of, behind or next to the vehicle.

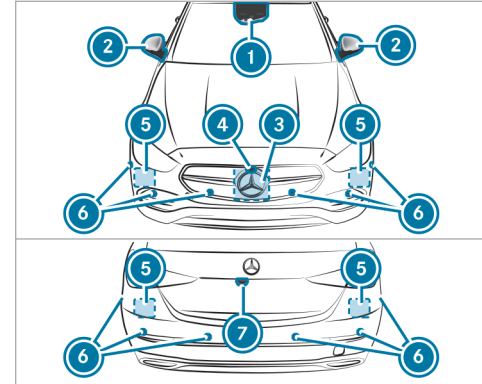

- ① Multifunction camera
- ② Cameras in the outside mirrors
- ③ Front radar
- ④ Front camera
- ⑤ Corner radars
- ⑥ Ultrasonic sensors
- ⑦ Rear-view camera

⚠ WARNING Risk of accident due to restricted detection performance of vehicle sensors and cameras

If the area around vehicle sensors or cameras is covered, damaged or dirty, certain driving and safety systems cannot function correctly. There is a risk of an accident.

- ▶ Keep the area around vehicle sensors or cameras clear of any obstructions and clean.
- ▶ Have damage to the bumper, radiator grille or stone chipping in the area of the front and rear windows repaired at a qualified specialist workshop.

Particularly, keep the areas around the sensors and cameras free of dirt, ice or slush (→ page 375). The sensors and cameras must not be covered and the detection ranges around them must be kept free. Do not attach additional license plate brackets, advertisements, stickers, car foils or rock chip protection films in the detection range of the sensors and cameras. Make sure

there are no overhanging loads protruding into the detection range.

If there is damage to a bumper or the radiator grill, or after an impact, have the function of the sensors checked at a qualified specialist workshop. Have damage or stone chipping in the area of the cameras on the front and rear windows repaired at a qualified specialist workshop.

- ⓘ The rear-view camera can extend and retract automatically for the purpose of calibration, even though there is no camera image on the display.

Overview of driving systems and driving safety systems

- ABS (→ page 231)
- BAS (→ page 231)
- ESP® (→ page 232)
- ESP® Crosswind Assist (→ page 233)
- EBD (→ page 233)
- STEER CONTROL steering assistance system (→ page 233)

- HOLD function (→ page 234)
- Hill Start Assist (→ page 235)
- ATTENTION ASSIST (→ page 235)
- Cruise control (→ page 237)
- Traffic Sign Assist (→ page 260)

Driving Assistance Package

- ⓘ The availability of some functions or partial functions of the Driving Assistance Package depends on the equipment or country. The functions of your Driving Assistance Package may differ from the functions listed here. The functions Active Distance Assist DISTRONIC, Active Blind Spot Assist, Active Brake Assist, Active Lane Keeping Assist and Active Emergency Stop Assist are, with restricted functions, also available without Driving Assistance Package.
- Active Distance Assist DISTRONIC (→ page 239)
- Active Speed Limit Assist (→ page 243)
- Route-based speed adaptation (→ page 244)
- Active Brake Assist (→ page 255)

- Active Steering Assist (→ page 246)
- Active Emergency Stop Assist (→ page 248)
- Active Lane Change Assist (→ page 250)
- Active Stop-and-Go Assist (→ page 246)
- Blind Spot Assist and Active Blind Spot Assist with exit warning (→ page 264)
- Active Lane Keeping Assist (→ page 268)
- PRE-SAFE® Impulse Side (→ page 50)

Parking Package

- ① Depending on the country, the rear-view camera is also available without Parking Package.
- ① The availability of individual functions depends on country and equipment.
 - Rear-view camera (→ page 271)
 - 360° camera (→ page 273)
 - Parking Assist PARKTRONIC (→ page 277)
 - Active Parking Assist (→ page 281)
 - Memory Parking Assist (→ page 290)

Function of ABS

The Anti-lock Brake System (ABS) regulates the brake pressure in critical driving situations:

- During braking, for instance, at maximum full-stop braking or if there is insufficient tire traction, the wheels are prevented from locking.
- Vehicle steerability while braking is ensured.

If ABS intervenes when braking, you will feel a pulsing in the brake pedal. The pulsating brake pedal can be an indication of hazardous road conditions and can serve as a reminder to take extra care while driving.

System limits

- ABS is active from speeds of approx. 3 mph (5 km/h).
- ABS may be impaired or may not function if a malfunction has occurred and the yellow  ABS warning lamp lights up continuously after the vehicle is started.

Function of BAS

⚠ WARNING Risk of an accident caused by a malfunction in BAS (Brake Assist System)

If BAS is malfunctioning, the braking distance in an emergency braking situation is increased.

▶ Depress the brake pedal with full force in emergency braking situations. ABS prevents the wheels from locking.

The Brake Assist System (BAS) supports your emergency braking situation with additional brake force.

If you depress the brake pedal quickly, BAS is activated:

- BAS automatically boosts the brake pressure.
- BAS can shorten the braking distance.
- ABS prevents the wheels from locking.

The brakes will function as usual once you release the brake pedal. BAS is deactivated.

ESP® (Electronic Stability Program)

Function of ESP®

⚠ WARNING Risk of skidding if ESP® is deactivated

If you deactivate ESP®, ESP® cannot carry out vehicle stabilization.

- ▶ ESP® should only be deactivated in the following situations.

! NOTE Mercedes-AMG vehicles

- ▶ Observe the notes in the Supplement. You could otherwise fail to recognize dangers.

The Electronic Stability Program (ESP®) can monitor and improve driving stability and traction in the following situations within physical limits:

- When starting off on wet or slippery roads.
- When braking.

If the vehicle deviates from the direction desired by the driver, ESP® can stabilize the vehicle by intervening in the following ways:

- One or more wheels are braked.
- The engine output is adapted according to the situation.

When ESP® is deactivated, the  warning lamp lights up continuously:

- Driving stability will no longer be improved.
- The drive wheels could spin.
- ETS/4ETS traction control is still active.

When the  warning lamp flashes, one or several wheels has reached its grip limit:

- Adapt your driving style to suit the current road and weather conditions.
- Do not deactivate ESP®.
- Depress the accelerator pedal only as far as is necessary when starting off.

To improve traction, ESP® can be switched off in the following situations:

- When using snow chains.
 - In deep snow.
 - On sand or gravel.
- i** Spinning the wheels results in a cutting action, which enhances traction.

If the  warning lamp lights up continuously, ESP® is not available due to a malfunction.

Observe the following information:

- Warning and indicator lamps (→ page 525)
- Display messages (→ page 449)

ETS/4ETS

ETS/4ETS traction control (Electronic Traction System) is part of ESP® and makes it possible to pull away and accelerate on a slippery road.

ETS/4ETS can improve the vehicle's traction by intervening in the following ways:

- The drive wheels are braked individually if they spin.

- More drive torque is transferred to the wheel or wheels with traction.

Influence of drive program on ESP®

The drive programs enable ESP® to adapt to different weather and road conditions as well as the driver's preferred driving style. (→ page 194) Depending on the selected drive program, the appropriate ESP® mode will be activated.

Function of ESP® Crosswind Assist

ESP® Crosswind Assist detects sudden gusts of side wind and helps the driver to keep the vehicle in the lane:

- ESP® Crosswind Assist operates at vehicle speeds between approximately 50 mph (80 km/h) and 125 mph (200 km/h) when you are driving straight ahead or cornering slightly.
- The system stabilizes the vehicle by applying the brakes to specific wheels on one side.

Activating/deactivating ESP® (Electronic Stability Program)

Multimedia system:



- ① ESP® can only be activated/deactivated using quick access when at least one other function is available in quick access. ESP® can otherwise be found in the **Assistance** menu.

- ▶ Select ESP®.
- ▶ Select On or  Off.

ESP® is deactivated if the  ESP® OFF warning lamp lights up continuously on the driver display.

Observe the information on the warning lamps and the display messages which may be shown on the driver display.

Function of EBD

Electronic Brakeforce Distribution (EBD) is characterized by the following:

- Monitoring and regulating the brake pressure on the rear wheels.
- Improved driving stability when braking, especially on bends.

Function of STEER CONTROL

STEER CONTROL assists you by transmitting a noticeable steering force to the steering wheel in the direction required for vehicle stabilization.

This steering recommendation is given in the following situations:

- both right wheels or both left wheels are on a wet or slippery road surface when you brake
- the vehicle starts to skid

System limits

STEER CONTROL may be impaired or may not function in the following situations:

- ESP® is deactivated.
- ESP® is malfunctioning.
- The steering is malfunctioning.

If ESP® is malfunctioning, you will be assisted further by the power steering.

HOLD function

■ HOLD function

The HOLD function holds the vehicle at a standstill without requiring you to depress the brake pedal, e.g. while you are waiting in traffic.

The HOLD function is only an aid. The responsibility for the vehicle safely standing still remains with the driver.

System limits

The HOLD function is intended only to provide assistance during driving and is not a sufficient

means of safeguarding the vehicle against rolling away when stationary.

- The gradient must not be greater than 30%.

■ Activating/deactivating the HOLD function



WARNING Risk of an accident due to the HOLD function being active when you leave the vehicle

If the vehicle is only braked with the HOLD function it could, in the following situations, roll away:

- If there is a malfunction in the system or in the power supply.
- If the HOLD function is deactivated by depressing the accelerator pedal or brake pedal, e.g. by a vehicle occupant.



Always secure the vehicle against rolling away before you leave it.

Requirements

- The vehicle is stationary.

- The driver's door is closed or the driver is correctly belted.
- The vehicle has been started or has been automatically switched off by the ECO start/stop function.
- The electric parking brake has been released.
- The transmission position **[D]**, **[R]** or **[N]** is engaged.

Activating the HOLD function

- ▶ Depress the brake pedal, and after a short time quickly depress further until the **[HOLD]** display appears on the driver display.
- ▶ Release the brake pedal.

Deactivating the HOLD function

- ▶ Depress the accelerator pedal to start off.
- or
- ▶ Depress the brake pedal until **[HOLD]** disappears from the driver display.

The HOLD function is also deactivated in the following situations:

- The parking position **[P]** is engaged.

- The vehicle is secured with the electric parking brake.

In the following situations, the vehicle is held by the parking position **P** and/or electric parking brake:

- The seat belt is unfastened and the driver's door is opened.
 - The vehicle is switched off.
 - There is a system malfunction.
 - The power supply is insufficient.
- ▶ Immediately depress the brake pedal firmly. The HOLD function is deactivated.
- ▶ Additionally secure the vehicle against rolling away.

Function of Hill Start Assist

⚠ WARNING Risk of accident and injury due to the vehicle rolling away

After a short time, Hill Start Assist no longer holds the vehicle.

▶ Swiftly move your foot from the brake pedal to the accelerator pedal. Do not leave the vehicle when it is being held by Hill Start Assist.

Hill Start Assist holds the vehicle for a short time when you pull away uphill under the following conditions:

- The transmission position **D** or **R** for starting off uphill is selected.
- The electric parking brake has been released.

This gives you enough time to move your foot from the brake pedal to the accelerator pedal and depress it without the vehicle rolling away immediately.

ATTENTION ASSIST

Function of ATTENTION ASSIST

ATTENTION ASSIST assists you on long, monotonous journeys, e.g. on freeways and highways. If signs of fatigue or increasing lapses in concentration on the part of the driver are detected, the system will suggest taking a break.

ATTENTION ASSIST serves solely as an aid. It cannot always promptly detect fatigue or lapses in concentration. The system is not a substitute for a well-rested and attentive driver. On long journeys, take regular, timely breaks to allow for adequate recovery.

You can choose between two settings:

- **Standard:** normal system sensitivity.
- **Sensitive:** higher system sensitivity. The driver will be warned earlier and the attention level detected by the system will be adapted accordingly.

If fatigue or increasing inattention is detected, the driver display will show the following warning: **ATTENTION ASSIST: Take a Break!** You can acknowledge the message and take a break if necessary. If you do not take a break and ATTENTION ASSIST continues to detect increasing lapses in concentration, you will be warned again after a minimum of 15 minutes.



The following information will be shown on the driver display:

- journey time since the last break.
- the attention level determined by ATTENTION ASSIST

The more segments ① of the circle displayed, the higher the detected attention level. Fewer segments ① will be displayed in the circle as the attention level decreases.

If ATTENTION ASSIST is unable to calculate the attention level and therefore cannot issue a warning, a message reading **System Suspended** will appear.

If the driver display shows a warning, the MBUX multimedia system will offer to search for a rest area. You can select a rest area and start navigation to this rest area.

When you restart the vehicle, ATTENTION ASSIST will automatically be switched on. The last selected sensitivity level will remain stored.

System limits

ATTENTION ASSIST will be active in the 37 mph (60 km/h) to 124 mph (200 km/h) speed range.

If the system is unavailable due to a malfunction, the  ATTENTION ASSIST warning lamp will light up continuously on the driver display.

Functionality of ATTENTION ASSIST will be restricted, and warnings may be delayed or not issued at all in the following situations in particular:

- If you have been driving for less than approximately 30 minutes
- If the road condition is poor (uneven road surface or potholes)
- If there is a strong side wind

- If you adopt a sporty driving style (high cornering speeds or high rates of acceleration)
- If the Active Steering Assist function of Active Distance Assist DISTRONIC is active
- If the clock is set to the incorrect time.
- If you change lanes and vary your speed frequently in active driving situations.
- If ESP® is not available

Refer also to the information regarding display messages that can be shown on the driver display. The ATTENTION ASSIST drowsiness or alertness assessment will be reset and restarted when you continue your journey in the following situations:

- If you switch off the vehicle.
- If you unfasten your seat belt and open the driver's door (e.g. to change drivers or take a break).

Setting ATTENTION ASSIST

Multimedia system:

- 
 ► Settings ► Assistance
 ► Assistance ► ATTENTION ASSIST

Setting the sensitivity

- Select  next to ATTENTION ASSIST.
- Select **Standard** or **Sensitive**.

Speed control cruise control

Function of cruise control

Cruise control regulates the speed to the value selected by the driver.



For example, the stored speed will not be deleted if you accelerate to overtake. If you remove your foot from the accelerator pedal after overtaking, cruise control will resume speed regulation back to the stored speed.

You can set any speed above 15 mph (20 km/h) up to the maximum design speed.

Observe the notes on driving systems and your responsibility; you may otherwise fail to recognize potential dangers (→ page 229).

Mercedes-AMG vehicles: cruise control is available up to a maximum speed of 155 mph (250 km/h).

Indicators on the driver display

-  **Gray:** cruise control is selected but not yet active or temporarily in passive mode.
-  **Green:** cruise control is active.

A stored speed will appear below the  display and be indicated on the speedometer.

System limits

Cruise control may be unable to maintain the stored speed on uphill gradients. The stored speed will be resumed when the gradient levels out.

On long and steep downhill gradients, you must shift down to a lower gear in good time. This is particularly important when you are driving a loaded vehicle. By doing so, you will make use of the engine's braking effect. This will take some of the

strain off the brake system and prevent the brakes from overheating and wearing too quickly.

Do not use cruise control in the following situations:

- in traffic situations that require frequent changes of speed, e.g. in heavy traffic, on winding roads
- on slippery roads. Accelerating may cause the drive wheels to lose traction and the vehicle could then skid.
- when visibility is poor

Operating cruise control

⚠ WARNING Risk of accident due to stored speed

If you call up the stored speed and this is lower than your current speed, the vehicle decelerates.

- Take into account the traffic situation before calling up the stored speed.

Requirements

- The transmission is in position **D**.

- The vehicle speed is at least 15 mph (20 km/h).
- ESP® must be activated, but not intervening.
- Cruise control is selected.

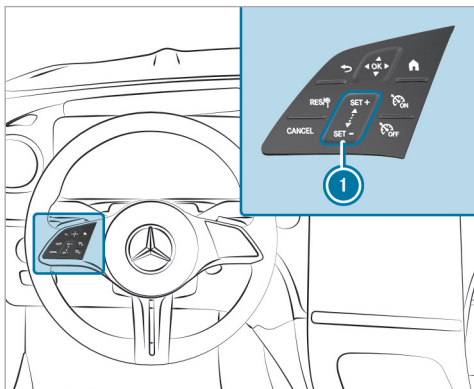

Steering wheel control panel for cruise control

RES+ Adopts the stored/detected speed

CANCEL Deactivates cruise control

1 **SET+** **SET-** Control panel to increase/decrease speed

CC ON Switches on cruise control

CC OFF Switches off cruise control

Switching on cruise control:

▶ Press **CC ON**.

Activating cruise control:

▶ Press **SET+** or **SET-** on the control panel 1. The current vehicle speed will be stored and maintained by the vehicle.

or

▶ Press **RES+**. The last stored speed will be called up and maintained by the vehicle. The current vehicle speed will be stored if the most recently stored speed has been deleted.

i When you switch off the vehicle, the last speed stored will be deleted.

Increasing/decreasing the stored speed:

▶ To increase the stored speed: swipe upwards from the bottom of the control panel 1.

- The stored speed will be increased by 1 mph (1 km/h).

▶ To decrease the stored speed: swipe downwards from the top of the control panel 1.

- The stored speed will be decreased by 1 mph (1 km/h).

or

▶ Briefly press **SET+** or **SET-** on control panel 1.

The stored speed will be increased or decreased to the following values depending on the unit:

- **mph:** the next value ending in 5
- **km/h:** the next value ending in 0

or

▶ Accelerate the vehicle to the desired speed.

▶ Press **SET+** on control panel 1.

Adopting a detected speed:

If cruise control is activated and Traffic Sign Assist has detected a traffic sign with a maximum

permissible speed and this is shown on the driver display:

- ▶ Press **RES/Ⓜ**.
The maximum permissible speed shown by the traffic sign will be stored and the vehicle will maintain that speed.

Deactivating cruise control

- ▶ Press **CANCEL**.

Switching off cruise control

- ▶ Press **ESP OFF**.

- ⓘ If you brake or deactivate ESP® or if ESP® intervenes, cruise control will be deactivated.

Active Distance Assist DISTRONIC

Function of Active Distance Assist DISTRONIC

- ⓘ The Active Distance Assist DISTRONIC described for vehicles without the Driving Assistance Package is an on-demand feature (country-dependent) (→ page 24).

Active Distance Assist DISTRONIC maintains the set speed on free-flowing roads. If vehicles are detected ahead the set distance is maintained, if necessary until the vehicle comes to a standstill. The vehicle accelerates or brakes depending on the distance to the vehicle in front and the set speed.

The speed and distance to the vehicle in front are set and saved using the steering wheel.

Available speed range:

- **Vehicles without Driving Assistance Package:**
15 mph (20 km/h) - 100 mph (160 km/h)
- **Vehicles with Driving Assistance Package:**
15 mph (20 km/h) - 130 mph (210 km/h)

Other features of Active Distance Assist DISTRONIC:

- Adjusts the driving style depending on the selected drive program
- Initiates acceleration to the stored speed if the turn signal indicator is switched on to change to the overtaking lane
- **Vehicles with Driving Assistance Package:**

- Reacts to stationary vehicles detected in urban speed ranges (except bicycles and motorcycles)
- Takes one-sided overtaking restrictions into account on freeways or multi-lane roads with separate roadways (country-dependent)

- ⓘ In the Active Distance Assist menu, it is possible to set the driving mode of Active Distance Assist DISTRONIC. Depending on the selected drive program, the driving behavior is energy-saving, comfortable or dynamic (→ page 245).

Vehicles with Active Parking Assist and Driving Assistance Package: if Active Distance Assist DISTRONIC has braked the vehicle to a standstill, it can automatically follow the vehicle in front when driving off again within 30 seconds if the system detects that the driver is touching the steering wheel. If a critical situation is detected in the surrounding area when you are driving off, such as a person in the vehicle path, a visual and acoustic warning indicates that the driver must

now take control of the vehicle. The vehicle is not accelerated any further.

Observe the notes on driving systems and your responsibility, otherwise you may fail to recognize potential dangers (→ page 229).

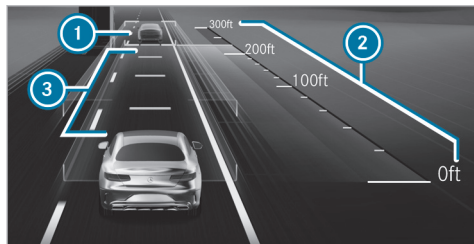

Notification on the driver display in the **Assistance** menu

- ① Vehicle in front
- ② Distance indicator
- ③ Set specified distance

The vehicle detected in front ① is highlighted in green. It may also be in the lane to the right of your vehicle in situations where it is not permitted

to overtake on the left, for example, on UK free-ways.

Permanent status display

 **Gray:** Active Distance Assist DISTRONIC selected but not yet active

 **Green speedometer, gray vehicle:** Active Distance Assist DISTRONIC active, speed set

 **Green:** Active Distance Assist DISTRONIC active and vehicle detected

The stored speed is shown under the permanent status display and highlighted in the speedometer. Active Distance Assist DISTRONIC's status display is grayed out when in passive mode.

If the speed of the vehicle in front or the ascertained target speed due to the route event ahead is less than the stored speed, the segments in the speedometer light up.

If you increase or decrease the set specified distance ③, the  display appears briefly.

① The green vehicle symbol  is displayed cyclically when the vehicle is ready to pull away.

① If the accelerator pedal is depressed while Active Distance Assist DISTRONIC is operational, the system can be switched to passive mode. The  **Suspended** message appears briefly on the driver display.

System limits

The system may be impaired or inoperative in the following instances, foreexample:

- In snow, rain, fog, heavy spray, if there is glare, in direct sunlight or in greatly varying ambient light.
- The windshield in the camera's area is dirty, fogged up, damaged or covered.
- If the radar sensors are dirty or covered.
- In parking garages or on roads with steep uphill or downhill gradients.
- If there are narrow vehicles in front, such as bicycles or motorcycles.

In addition, one or more wheels may lose grip due to braking or acceleration on smooth or slippery roads, and the vehicle may begin skidding. If

ESP® intervenes, Active Distance Assist DISTRONIC is deactivated.

Do not use Active Distance Assist DISTRONIC in these situations.

⚠ WARNING Risk of accident from acceleration or braking by Active Distance Assist DISTRONIC

Active Distance Assist DISTRONIC may accelerate or brake in the following cases, for example:

- If the vehicle pulls away using Active Distance Assist DISTRONIC.
- If the stored speed is called up and is considerably faster or slower than the currently driven speed.
- If Active Distance Assist DISTRONIC no longer detects a vehicle in front or does not react to relevant objects.

▶ Always carefully observe the traffic conditions and be ready to brake at all times.

▶ Take into account the traffic situation before calling up the stored speed.

⚠ WARNING Risk of accident due to insufficient deceleration by Active Distance Assist DISTRONIC

Active Distance Assist DISTRONIC brakes your vehicle with up to 50% of the possible deceleration. If this deceleration is not sufficient, Active Distance Assist DISTRONIC alerts you with a visual and acoustic warning.

- ▶ Adjust your speed and maintain a suitable distance from the vehicle in front.
- ▶ Brake the vehicle yourself and/or take evasive action.

⚠ WARNING Risk of accident if detection function of Active Distance Assist DISTRONIC is impaired

Active Distance Assist DISTRONIC does not react or has a limited reaction:

- when driving on a different lane or when changing lanes
- to pedestrians, animals, bicycles or stationary vehicles, or unexpected obstacles
- to complex traffic conditions
- to oncoming vehicles and crossing traffic

As a result, Active Distance Assist DISTRONIC may neither give warnings nor intervene in such situations.

▶ Always observe the traffic conditions carefully and react accordingly.

■ Operating Active Distance Assist DISTRONIC

Requirements

- The electric parking brake has been released.
- ESP® is switched on and is not intervening.

- Transmission position **D** is engaged.
- All the doors are closed.
- The check on the radar sensor system has been successfully completed.

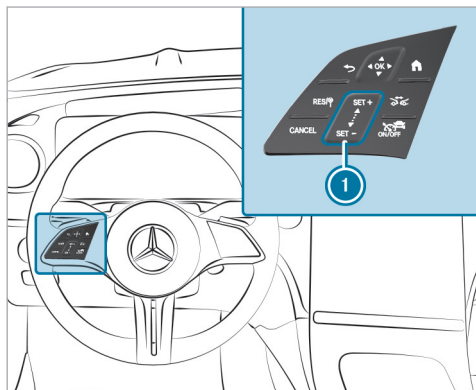



RES/SET

CANCEL

Adopts the stored/detected speed
Deactivates Active Distance Assist
DISTRONIC

1 SET+ SET- Control panel to increase/decrease speed

 Increases/decreases the specified distance

 Activates/deactivates Active Distance Assist DISTRONIC

▶ **To operate Active Distance Assist DISTRONIC:** press the respective button with only one finger or swipe across the control panel.

Activating/deactivating Active Distance Assist DISTRONIC

▶ Press .

Activating Active Distance Assist DISTRONIC

▶ **To activate without a stored speed:** press control panel 1 on the top SET+ or bottom SET- or press RES/SET. Remove your foot from the accelerator pedal.

or

▶ **To activate with a stored speed:** press RES/SET. Remove your foot from the accelerator pedal. The last stored speed will be called up and maintained by the vehicle.

If the stored speed has been deleted, the current vehicle speed will be stored.

Increasing/decreasing the speed

▶ To increase the stored speed: swipe upwards from the bottom of the control panel 1.

- The stored speed will be increased by 1 mph (1 km/h).

▶ To decrease the stored speed: swipe downwards from the top of the control panel 1.

- The stored speed will be decreased by 1 mph (1 km/h).

or

▶ Briefly press the top SET+ or bottom SET- of control panel 1.





The stored speed will be increased or decreased by 5 mph (10 km/h).

or

▶ Accelerate the vehicle to the desired speed.

- ▶ Press the top  of control panel .

Adopting the speed restriction shown on the driver display

- ▶ Activate the Active Distance Assist DISTRONIC: press ,  or .
- ▶ Adopt the displayed speed restriction: press .
The speed restriction shown on the driver display will be adopted as the stored speed. The vehicle will adapt its speed to that of the vehicle in front, but only up to the stored speed, or will limit its speed accordingly.

-  A speed restriction shown on the driver display will be adopted only while the vehicle is in motion, not when it is stationary.



Pulling away with Active Distance Assist DISTRONIC

- ▶ Activate Active Distance Assist DISTRONIC and remove your foot from the brake pedal.
- ▶ Press .

or

- ▶ Depress the accelerator pedal briefly and firmly.
The functions of Active Distance Assist DISTRONIC will remain active.

Increasing/decreasing the specified distance from the vehicle in front

- ▶ Press .
The  indicator will appear. The specified distance will be reduced by one level.
If the lowest level is already selected, the selection will jump to the highest level.

Deactivating Active Distance Assist DISTRONIC

-  **WARNING** Risk of an accident due to Active Distance Assist DISTRONIC being active when you leave the driver's seat

If you leave the driver's seat while the vehicle is being braked by Active Distance Assist DISTRONIC only, the vehicle can roll away.

- ▶ Always deactivate Active Distance Assist DISTRONIC and secure the vehicle to

prevent it from rolling away before you leave the driver's seat.

- ▶ Press .

-  If you brake or deactivate ESP[®] or if ESP[®] intervenes, Active Distance Assist DISTRONIC will be deactivated.

Function of Active Speed Limit Assist

If a changed speed limit is detected and the automatic adoption of speed limits is switched on, this is automatically adopted as the stored speed (→ page 245). Speed limits below 12 mph (20 km/h) are not accepted.

Adjustment of travel speed is initiated no later than when the vehicle is level with the traffic sign. For signs indicating entry into an urban zone, the speed is adapted according to that permitted within the built-up area. The speed restriction indicator on the driver display is always refreshed when the vehicle is level with the traffic sign.

If you are driving on German freeways with no speed limit, the system uses the speed stored for a stretch of road with no speed limit as the set

speed. If you do not alter the stored speed on a stretch of road with no speed limit, the recommended speed of 80 mph (130 km/h) is adopted.

If Active Distance Assist DISTRONIC has been switched to passive mode by pressing the accelerator pedal, only speed limits that are higher than the set speed are adopted.

The maximum permissible speed does not take the road condition and current weather and traffic conditions into consideration. Adjust your speed accordingly when necessary.

Observe the notes on driving systems and your responsibility, otherwise you may fail to recognize potential dangers (→ page 229).

System limits

The system limits of Traffic Sign Assist apply to the detection of traffic signs (→ page 260).

Speed limits below 12 mph (20 km/h) are not automatically adopted by the system as the stored speed. Temporary speed restrictions (e.g. for a specific time or due to weather conditions) cannot be unequivocally detected by the system.

Adjust your speed in these situations.

⚠ WARNING Risk of accident due to adjustment of speed by Active Speed Limit Assist.

The speed adopted by the Active Speed Limit Assist may be too high or incorrect in individual cases:

- At limit speeds below 12 mph (20 km/h)
- In wet or foggy conditions

▶ Ensure that the speed being driven always complies with the traffic laws.

▶ Adjust the speed being driven to the current traffic and weather conditions.

■ Function of route-based speed adaptation

When Active Distance Assist DISTRONIC is activated, the vehicle speed will be adapted accordingly to the route events ahead. Depending on the drive program selected, the vehicle will negotiate a route event ahead in an energy-saving, comfortable or dynamic manner. When the route event has been passed, the vehicle will accelerate again to the stored speed. The set distance to the vehicle

in front, vehicles detected ahead and speed restrictions ahead will be taken into account.

Route-based speed adaptation can be activated in the multimedia system (→ page 245).

The following route events will be taken into account:

- Bends
- Traffic circles
- T-intersections
- Turns and exits
- Traffic jams ahead (only with Live Traffic)

Also, the speed will be reduced if the turn signal indicator is switched on and one of the following situations is detected:

- Turning off at intersections
- Driving in slowing-down lanes
- Driving in lanes adjacent to slowing-down lanes

The driver is responsible for choosing the right speed and observing other road users. This applies in particular to intersections, traffic circles

and traffic lights, as route-based speed adaptation does not brake the vehicle to a standstill.

When route guidance is active, the first speed adjustment will be carried out automatically. If the turn signal indicator is switched on, the selected route will be confirmed and further speed adjustment will be activated.

Speed adjustment will be canceled in the following cases:

- If the turn signal indicator is switched off before the route event and it is therefore assumed that the route event is not relevant to the driver
- If the driver depresses the accelerator or brake pedal during the process

System limits

Route-based speed adaptation does not take right of way regulations into account. The driver is responsible for complying with road traffic regulations and driving at a suitable speed.

In difficult conditions, the speed selection made by the system may not always be suitable. This applies to the following situations, for example:

- The road's course is not clearly visible
- Road narrowing
- Varying maximum permissible speeds in individual lanes, e.g. at toll stations
- Wet road surfaces, snow or ice

The driver will need to intervene accordingly in these situations.

⚠ WARNING Risk of accident in spite of route-based speed adaptation

Route-based speed adaptation can malfunction or be temporarily unavailable in the following situations:

- If the driver does not follow the calculated route
- If map data is not up-to-date or available
- In the event of roadworks
- In bad weather or road conditions

- If the accelerator pedal is depressed
 - In the event of electronically displayed speed limitations
- ▶ Adapt the speed to the traffic situation.

■ Setting Active Distance Assist DISTRONIC driving styles

Requirements:

- Active Distance Assist DISTRONIC is activated.

Multimedia system:

→  **» Settings » Assistance**
» Driving » Active Distance Assist

Selecting a driving style

▶ Select **Based on DYNAMIC SELECT**, **Dynamic** or **Comfortable**.

i Additional information on Active Distance Assist DISTRONIC (→ page 241).

Setting speed adaptation

▶ Select **Route Based** or **Speed limit**.

When these functions are active, the travel speed is adapted depending on the route events ahead or in accordance with a speed restriction.

- ❶ If one of the following systems is activated, the detected speed can be manually adopted as the maximum permissible speed:
 - Active Distance Assist DISTRONIC
 - Cruise control
 - Variable limiter
- ❷ Additional information on speed adaptation (→ page 244).

■ **Function of Active Stop-and-Go Assist**

Active Stop-and-Go Assist helps you in traffic jams on multi-lane roads with separated roadways by automatically pulling away within up to 60 seconds and with moderate steering maneuvers. It orients itself using the vehicle in front and lane markings. Active Stop-and-Go Assist automatically maintains a safe distance from the vehicle in front and vehicles cutting in.

Active Stop-and-Go Assist requires you, as the driver, to keep your hands on the steering wheel at all times so that you can intervene at any time to correct the course of the vehicle and keep it in the lane.

Observe the notes on driving systems and your responsibility; you may otherwise fail to recognize potential dangers (→ page 229).

Active Stop-and-Go Assist will activate automatically when all the following conditions are met:

- You are in a traffic jam on a highway or major high-speed road.
- Active Distance Assist DISTRONIC is activated and active (→ page 241).
- Active Brake Assist is available (→ page 255).
- Active Steering Assist is switched on and active (→ page 248).
- You are traveling at a speed no greater than 35 mph (60 km/h).

When Active Stop-and-Go Assist is active, the  status indicator will appear on the driver display.

System limits

The system limits of Active Distance Assist DISTRONIC and Active Steering Assist apply to Active Stop-and-Go Assist.

Active Steering Assist

■ **Function of Active Steering Assist**

Active Steering Assist is available up to a speed of 130 mph (210 km/h).





The system helps you to stay in the center of the lane by means of moderate steering interventions. Depending on the vehicle speed, Active Steering Assist uses the vehicles ahead and lane markings as a reference.





- ❶ Depending on the respective country, Active Steering Assist can use the surrounding traffic as a reference in the lower speed range. If necessary, Active Steering Assist can also assist when you are driving outside the center of the lane, for example, to form an emergency corridor.

If the detection of lane markings and vehicles ahead is impaired, Active Steering Assist switches

to passive mode. The system provides no support in this case.

Status display of Active Steering Assist

-  **Gray:** activated and in passive mode
-  **Green:** activated and active
-  **Red, flashing:** prompt to the driver to actively confirm or transition from active to passive mode, system limits detected
-  **White, red hands:** "hands on the steering wheel" prompt

-  During the transition from active to passive mode, the  symbol is shown as enlarged and flashing. Once the system is in passive mode, the  symbol is shown as gray on the driver display.
-  Depending on the selected vehicle settings, Active Steering Assist may be unavailable.

Steering and touch detection

The driver is required to keep their hands on the steering wheel at all times to ensure that they can intervene at any time to correct the course of the vehicle and keep it in lane. The driver must expect

a change from active to passive mode or vice versa at any time.



If the system detects that the driver has not steered the vehicle for a considerable period of time or has removed their hands from the steering wheel, an initial visual warning is issued. The notification  appears on the driver display. If the driver still does not steer the vehicle, or gives no confirmation to the system, a warning tone sounds in addition to the visual warning message. (→ page 248) If the driver does not react to this warning for a considerable period, an emergency stop may be initiated.

The warning is not issued or stops as soon as the system detects the driver touching or steering the steering wheel.

Touch detection may be limited or inoperative if there is no direct contact between the hand and the steering wheel, e.g. when you are wearing gloves or if there is a steering wheel cover on the steering wheel.

If Active Steering Assist detects that a system limit has been reached, a visual warning is issued and a warning tone sounds.

Observe the notes on driving systems and your responsibility, otherwise you may fail to recognize potential dangers (→ page 229).

System limits

Active Steering Assist has a limited steering torque for lateral guidance. In some cases, the steering intervention is not sufficient to keep the vehicle in the lane or to drive through exits.

The system may be impaired or inoperative in the following situations:

- There is poor visibility, e.g. due to snow, rain, fog, heavy spray, greatly varying ambient light or dense shadows on the road.
- There is glare, e.g. from oncoming traffic, direct sunlight or reflections.
- Insufficient road illumination.
- The windshield is dirty, fogged up, damaged or covered in the vicinity of the camera, e.g. by a sticker.
- There are no lane markings in a given lane, or the markings are not easily discernible or change quickly, for example, in a construction area or at intersections.
- The lane markings are worn away, dark or covered up, e.g. by dirt or snow.
- If the distance to the vehicle in front is too short and the lane markings can therefore not be detected.
- The roadway is narrow and winding.
- There are obstacles on the lane or projecting out into the lane, such as object markers.

The system does not provide assistance in the following conditions:

- On very tight bends and when turning.
- When crossing intersections.
- At traffic circles or toll stations.
- When actively changing lane without switching on the turn signal indicator.
- When the tire pressure is too low.

⚠ WARNING Risk of accident if Active Steering Assist unexpectedly stops functioning

If the system limits of Active Steering Assist are reached there is no guarantee that the system will remain active or will keep the vehicle in lane.

- ▶ Always keep your hands on the steering wheel and observe the traffic carefully.
- ▶ Always steer the vehicle paying attention to traffic conditions.

⚠ WARNING Risk of accident if Active Steering Assist unexpectedly intervenes

The detection of lane markings and objects may malfunction and cause unexpected steering interventions.

- ▶ Steer according to traffic conditions.

■ Activating/deactivating Active Steering Assist

Requirements

- ESP® is activated, but is not intervening.
- Active Distance Assist DISTRONIC is activated.

Multimedia system:

- ▶  ▶ Settings ▶ Assistance
- ▶ Driving
- ▶ Activate or deactivate **Active Steering Assist**.

Function of Active Emergency Stop Assist

Active Emergency Stop Assist monitors the steering wheel, as well as the accelerator and brake pedals. If the system detects a lack of driver activ-

ity or the vehicle is in danger of leaving the lane, a warning can be issued and an emergency stop initiated.

Vehicles without Driving Assistance Package: The system is available from a speed of approx. 37 mph (60 km/h).

Vehicles with Driving Assistance package: If Active Steering Assist is switched off, the system is available from a speed of approx. 37 mph (60 km/h).

If the system detects that the vehicle is in danger of leaving the lane, a warning can be issued and an emergency stop initiated.

- The driver has not touched the steering wheel for a certain while, or no steering movement is detected for a lengthy period (depending on the vehicle equipment).
 - Neither the accelerator nor the brake pedal is depressed.
- i Vehicles with Driving Assistance package:** if Active Steering Assist is switched on and active, the system monitors only the steering wheel. If the driver has not touched the steer-

ing wheel for a certain while, a warning may be issued despite pedal actuation. Observe also the instructions on the touch detection of Active Steering Assist (→ page 246).



Active Emergency Stop Assist issues the following warnings in order:

- Display message **1** appears in the driver display.
- In addition to display **1**, a warning tone sounds.
- The **Initiating Emergency Stop** message appears in the driver display, a continuous

warning tone sounds and the vehicle will no longer accelerate. Additionally, a slight tensioning of the belt will be generated as required.

- The vehicle speed is reduced in increments until the vehicle comes to a standstill. Sharp brake impulses are also effected.
- i Vehicles with Driving Assistance Package:** If Active Distance Assist DISTRONIC is active and the driver unfastens the seat belt and opens the driver's door, an emergency stop can be initiated immediately.

Vehicles with Driving Assistance package: If possible, a lane change to the adjacent lane is performed (country-dependent). It is possible to change lanes across one lane and only to the outside lane, not to the hard shoulder.

When automatic braking is initiated, Active Distance Assist DISTRONIC is deactivated. Depending on the respective country, the hazard warning light system is also switched on.

When the vehicle has come to a standstill:

- The vehicle is secured with the electric parking brake.
- The vehicle is unlocked.
- If possible, an emergency call is made to the Mercedes-Benz emergency call center.

Before automatic braking is initiated, you can cancel Active Emergency Stop Assist by turning the steering wheel.

You can cancel an intervention by Active Emergency Stop Assist after automatic braking is initiated by performing one of the following actions:

- Accelerating or braking: the emergency stop is canceled, but the warning message, warning tone and electric power steering remain active
- Steering: electric power steering is canceled, the warning message and warning tone remain active and the vehicle continues to be braked

 Active Emergency Stop Assist can initiate an emergency stop a maximum of three times within a driving cycle. After that, Active Steering Assist and Active Emergency Stop Assist

are disabled until the vehicle has been restarted.



System limits

For the detection of vehicles and other obstacles, observe the system limits of the following functions:

- Active Distance Assist DISTRONIC (→ page 239)
- Active Steering Assist (→ page 246)
- Active Lane Change Assist (→ page 250)
- Active Lane Keeping Assist (→ page 268)
- Active Brake Assist (→ page 255)

Vehicles without Driving Assistance Package:

Active Emergency Stop Assist is inactive in the following cases:

- Active Lane Keeping Assist has reached a system limit.
-  Active Lane Keeping Assist is switched off (white status display).
-  Active Lane Keeping Assist is not ready (gray status display).

Active Lane Change Assist

Function of Active Lane Change Assist

Active Lane Change Assist is activated via the turn signal indicator, and supports the driver when changing lanes by applying steering torque.

The following conditions must be met for this function:

- You are driving on a freeway or a main road similar to a freeway.
- The travel speed is between approximately 40 mph (65 km/h) and 112 mph (180 km/h).
- A dashed boundary marking separates the adjacent lane.
- No vehicle or obstacle is detected in the adjacent lane.
- Active Lane Change Assist is selected in the multimedia system (→ page 254).
- Active Distance Assist DISTRONIC and Active Steering Assist are switched on and are active.

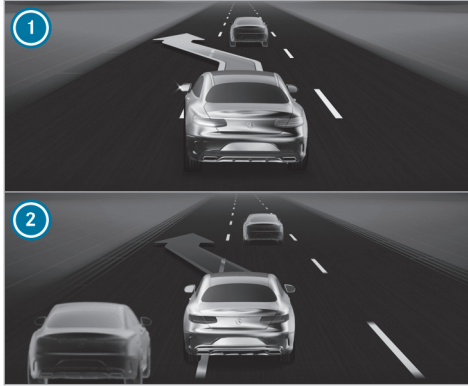



Notification on the driver display in the menu **Assistance**

- ① Green arrow: lane change initiated
- ② Red arrow: lane change canceled

If Active Lane Change Assist is available, the notification  appears with green arrows on the driver display. If the system has been activated but is not currently available, the notification

 appears with gray arrows on the driver display.

If no vehicle or obstacle is detected in the adjacent lane, and a lane change is permitted, the lane change is initiated as soon as the driver activates the turn signal indicator. The lane change is indicated to the driver by a green flashing arrow next to the steering wheel symbol . In the **Assistance** menu, a green arrow ① indicating the respective adjacent lane appears on the driver display. The message **Lane Change to the Left**, for example, also appears.

If it is not possible to change lanes immediately after switching on the turn signal indicator because, for example, an obstacle has been detected, the arrow next to the steering wheel symbol  also flashes green. The adjacent lane continues to be monitored. When the lane becomes accessible, a lane change is carried out and the **Lane Change to the Left** message, for example, appears on the driver display. When the green arrows stop flashing, activate the lane change again.

Active Lane Change Assist can be canceled in the following situations, for example:

- The environmental conditions change (e.g. obstacle detected).
- The driver steers too hard or in the opposite direction.
- The driver switches on the turn signal indicator in the opposite direction.
- Active Distance Assist DISTRONIC or Active Steering Assist are deactivated.
- The lane change cannot be executed by the vehicle as planned.

A cancellation of Active Lane Change Assist is displayed as follows:

- The arrow in the selected direction of travel turns red.
- A corresponding message appears on the driver display.
- In certain circumstances a warning tone sounds.

⚠ WARNING Risk of accident when changing lane to an occupied adjacent lane

Lane Change Assist cannot always clearly detect if the adjacent lane is free.

The lane change might be initiated although the adjacent lane is not free.

- ▶ Before changing lanes, make sure that the neighboring lane is free and there is no danger to other road users.
- ▶ Monitor the lane change.

⚠ WARNING Risk of accident if Lane Change Assist unexpectedly stops functioning

If the system limitations for Lane Change Assist have been reached, there is no guarantee that the system will remain active.

Lane Change Assist cannot then assist you by applying steering torque.

- ▶ Always monitor the lane change and keep your hands on the steering wheel. Observe the traffic conditions and steer and/or brake if necessary.

Automatic lane change

Automatic Lane Change is a sub-function of Active Lane Change Assist. It can assist the driver in deciding when a lane change is appropriate, as well as its subsequent execution.

⚠ WARNING Risk of accident due to incorrectly triggered lane change

The system cannot always clearly recognize all situations in which a lane change is appropriate.

The system can initiate a lane change even though the traffic situation is not suitable or the neighboring lane is not available, not usable or occupied.

- ▶ Always monitor the traffic situation.
- ▶ If necessary, cancel the lane change by holding the steering wheel or countersteering slightly and return the vehicle to its own lane.

You can cancel a lane change initiated by the system at any time by holding the steering wheel or

countersteering slightly and returning the vehicle to its lane.

The following conditions must be fulfilled for an automatic lane change:

- The conditions for activating Active Lane Change Assist are fulfilled.
 - Automatic lane change is switched on in the multimedia system (→ page 254).
 - You are driving on a freeway, or a main road similar to a freeway, in a country for which this function is approved.
 - The road currently being traveled allows lane changes. There are no tight bends, for example.
 - The travel speed is between approximately 40 mph (65 km/h) and 85 mph (140 km/h).
- i** If you are not in a country for which this function is approved, the menu item for Automatic Lane Change is not available in the multimedia system.

Active Lane Change Assist can initiate an automatic lane change in the following situations, for example:

- The set desired speed for Active Distance Assist DISTRONIC cannot be reached due to a slower vehicle in front.
- There is little traffic, and the set desired speed for Active Distance Assist DISTRONIC can also be achieved in a slower lane.
- A lane change is necessary in order that the route entered in the navigation system, or the road currently being navigated can be followed. The lane change can already take place before the prompt to do so appears in the navigation system.
- The system detects that the lane being traveled in is about to end.
- You are in the slowest speed lane.

In the following situations in particular, Active Lane Change Assist does not perform an automatic lane change:



- If the vehicle is already in a lane that should be used to follow the route entered in the navigation system.
- On some route sections, no lane change is initiated to the slowest speed lanes.
- The system detects that the adjacent lane is about to end.
- If the driver has canceled an automatic lane change, no lane change will be initiated in this direction for a certain period of time. Automatic Lane Change is then temporarily switched to passive mode for this direction.
- If the driver has initiated a lane change in a given direction or has changed lanes themselves, no lane change is initiated in the opposite direction for a certain period of time. Automatic Lane Change is then temporarily switched to passive mode for this direction.

The same cancellation conditions apply to Automatic Lane Change as for the lane change initiated by the driver with Active Lane Change Assist.

In addition, Automatic Lane Change can be canceled under the following circumstances in particular:

- During the lane change, the system detects a construction site separated by traffic cones, in its own or in the adjacent lane.
- The system recognizes that the reason for a lane change no longer exists.

Notifications on the driver display

If Automatic Lane Change is available, in place of the notification , the notification  appears in green.

If Automatic Lane Change is available but not all conditions for activating the function are currently fulfilled, the **A**- symbols are shown in gray. Depending on the respective country, only an **A** can be shown in gray. Automatic Lane Change is then temporarily switched to passive mode for this direction. This will be implemented, for exam-

ple, if the driver has canceled an automatic lane change or has initiated a lane change themselves.

If the system deems a lane change appropriate and has to adjust the travel speed accordingly, the green **A** flashes on the side to which a lane change is to take place.

When the automatic lane change is initiated, the driver display shows a vehicle with an arrow pointing to the adjacent lane in which the lane change is to take place, and a warning tone sounds. Additionally, it is possible for the reason for a lane change, for example an overtaking maneuver, to be shown.

If Automatic Lane Change is canceled, the **A** on the side to which a lane change was to take place is shown in red on the display . Under certain circumstances, warning messages can also be displayed and an additional warning tone sounded.

System limits

For Active Lane Change Assist, the system limits of Active Steering Assist (→ page 246) apply.



In addition, the system may be impaired or inoperative in the following situations:

- The sensors are damaged, covered or dirty (→ page 229).
- The exterior lighting indicates a defect.
- The system does not recognize a suitable road, e.g. in narrow bends.
- The vehicle is within a construction site.

Automatic lane change may be inoperative or impaired in the following situations in particular, and may lead to lane changes being initiated erroneously:

- The vehicle is before or within a construction site and/or the system has detected a construction site separated by traffic cones.
- The vehicle is within a section with temporary lane closures or lane openings.
- The system can no longer detect the lane marking correctly.
- It is raining heavily.

- Another vehicle changes to the same lane simultaneously, e.g. incoming traffic from slip roads.



 Active Lane Change Assist sensors adjust automatically while a certain distance is being driven after the vehicle has been delivered. Active Lane Change Assist is unavailable during this teach-in process, and no arrows are displayed next to the Active Steering Assist symbol .

Observe the notes on driving systems and your responsibility; you may otherwise fail to recognize potential dangers (→ page 229).

Setting Active Lane Change Assist

Multimedia system:

  **Settings**  **Assistance**
 **Driving**  **Active Lane Change Assist**

-  Select between the **On** or **Off** setting options.
-  Select **On**, **Also Automatically** or **Off** from the setting options.

The setting option **Also Automatically** can also be switched on or off in the quick-access menu.

- ❗ If the **Active Steering Assist** was switched off, then the **Active Lane Change Assist** cannot be operated.

Active Brake Assist

Function of Active Brake Assist

Active Brake Assist consists of the following functions:

- Collision warning
- Autonomous braking function
- Situation-based brake force boosting
- **Vehicles with Driving Assistance Package and Active Steering Assist:** Evasive Steering Assist
- **Vehicles with Driving Assistance Package:** Evasive Steering Assist
- **Vehicles with Driving Assistance Package:** Intersection start-off function

Active Brake Assist can help you to minimize the risk of a collision with vehicles, cyclists or pedestrians or to reduce the effects of such a collision.

If Active Brake Assist has detected a risk of collision, a warning tone will sound and the  distance warning lamp will light up.

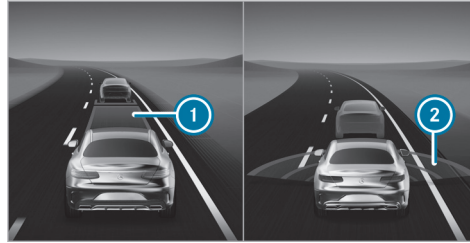

Indicator on the **Assistance** menu on the driver display

- ① Distance insufficient
- ② Red radar waves

On the **Assistance** menu, an insufficient distance to the vehicle in front ① will be displayed in red. If you reduce the distance further, the vehicle in front will also be highlighted in red. When the system detects a risk of collision, red radar waves ② will appear in front of your vehicle.

- ❗ **Vehicles with PRE-SAFE®:** depending on the country, an additional haptic warning will occur in the form of slight, repeated tensioning of the driver's seat belt.
- ❗ **Vehicles with active ambient lighting:** if **Warning Support** is activated, the Active Brake Assist warning will also be accompanied by ambient lighting (→ page 151).

If you do not react to the warning, autonomous braking may be initiated in critical situations.

In particularly critical situations, Active Brake Assist may also initiate autonomous braking directly. In this case, the warning tone and  distance warning lamp will be activated at the same time as brake application.

If you apply the brakes yourself in a critical situation or apply the brakes during autonomous braking, situation-dependent brake force boosting will occur. The brake pressure will increase up to maximum emergency braking if necessary.



If autonomous braking or situation-dependent brake force boosting has occurred, pop-up ① will appear on the driver display and then automatically disappear after a short time.

If the autonomous braking function or the situation-based braking assistance is triggered, additional preventive measures for occupant protection may also be initiated by PRE-SAFE®.

⚠ WARNING Risk of an accident caused by limited detection performance of Active Brake Assist

Active Brake Assist cannot always clearly identify objects and complex traffic situations.

In such cases, Active Brake Assist might:

- Give a warning or brake without reason
- Not give a warning or not brake

Active Brake Assist is only an aid. The driver is responsible for maintaining a sufficiently safe distance to the vehicle in front, vehicle speed and for braking in good time.

- ▶ Always pay careful attention to the traffic situation; do not rely on Active Brake Assist alone.
- ▶ Be prepared to brake or swerve if necessary.

If Active Brake Assist is deactivated or the functions are restricted, e.g. owing to activation of another driving system, the  Active Brake Assist warning lamp will appear on the driver display.

If the system is unavailable owing to dirty or damaged sensors or a malfunction, or if the functions are restricted, the Active Brake Assist  warning lamp will appear on the driver display.

Also observe the system limits of Active Brake Assist.

The individual subfunctions are available in the following speed ranges:

Collision warning

The collision warning function can assist you in the following situations from approximately 4 mph (7 km/h) with an intermittent warning tone and the  distance warning lamp.

Vehicles without Driving Assistance Package:

- at speeds up to approximately 155 mph (250 km/h) when approaching moving vehicles ahead.
- at speeds up to approximately 50 mph (80 km/h) when approaching stationary vehicles, pedestrians walking along the road and moving cyclists ahead.
- at speeds up to approximately 43 mph (70 km/h) when approaching crossing pedestrians and cyclists.
- at speeds up to approximately 37 mph (60 km/h) when approaching stationary pedestrians and cyclists.

Vehicles with Driving Assistance Package:

- at speeds up to approximately 155 mph (250 km/h) when approaching moving vehicles ahead.
- at speeds up to approximately 75 mph (120 km/h) when approaching crossing vehicles, pedestrians and cyclists.
- at speeds up to approximately 62 mph (100 km/h) when approaching stationary vehicles.
- at speeds up to approximately 50 mph (80 km/h) when approaching moving cyclists ahead.
- at speeds up to approximately 43 mph (70 km/h) when approaching stationary pedestrians and cyclists.

Autonomous braking function

From a speed of approximately 4 mph (7 km/h), the autonomous braking function may intervene in the following situations:

Vehicles without Driving Assistance Package:

- at speeds up to approximately 155 mph (250 km/h) when approaching moving vehicles ahead.
- at speeds up to approximately 50 mph (80 km/h) when approaching moving cyclists ahead, pedestrians walking along the road and stationary vehicles.
- at speeds up to approximately 43 mph (70 km/h) when approaching crossing pedestrians and cyclists.

Vehicles with Driving Assistance Package:

- at speeds up to approximately 155 mph (250 km/h) when approaching moving vehicles ahead.
- at speeds up to approximately 75 mph (120 km/h) when approaching crossing vehicles, pedestrians and cyclists.
- at speeds up to approximately 62 mph (100 km/h) when approaching stationary vehicles.

- at speeds up to approximately 50 mph (80 km/h) when approaching moving cyclists ahead.
- at speeds up to approximately 43 mph (70 km/h) when approaching stationary pedestrians and cyclists.

Situation-based brake force boosting

From a speed of approximately 4 mph (7 km/h), situation-related brake force boosting may intervene in the following situations:

Vehicles without Driving Assistance Package:

- at speeds up to approximately 155 mph (250 km/h) when approaching moving vehicles ahead.
- at speeds up to approximately 50 mph (80 km/h) when approaching moving cyclists ahead, pedestrians walking along the road and stationary vehicles.
- at speeds up to approximately 43 mph (70 km/h) when approaching crossing pedestrians and cyclists.

- at speeds up to approximately 37 mph (60 km/h) when approaching stationary pedestrians and cyclists.

Vehicles with Driving Assistance Package:

- at speeds up to approximately 155 mph (250 km/h) when approaching moving vehicles ahead.
- at speeds up to approximately 75 mph (120 km/h) when approaching crossing vehicles, pedestrians and cyclists.
- at speeds up to approximately 62 mph (100 km/h) when approaching stationary vehicles.
- at speeds up to approximately 50 mph (80 km/h) when approaching moving cyclists ahead.
- at speeds up to approximately 43 mph (70 km/h) when approaching stationary pedestrians and cyclists.

Canceling brake application by Active Brake Assist

You can cancel brake application by Active Brake Assist at any time by:

- Fully depressing the accelerator pedal or with kickdown.
- Releasing the brake pedal.

Active Brake Assist may cancel brake application when one of the following conditions is fulfilled:

- You steer to avoid an obstacle.
- There is no longer a risk of collision.
- An obstacle is no longer detected in front of your vehicle.

Reaction to oncoming road users (vehicles with Driving Assistance Package only)

Active Brake Assist can also react to detected oncoming road users:

- Reaction up to a speed of approximately 62 mph (100 km/h)
- Warning of oncoming road users through warning tone and distance warning lamp 

- Autonomous braking application in order to reduce the severity of an accident

Intersection start-off function (vehicles with Driving Assistance Package only)

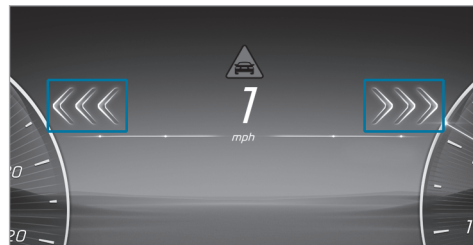

If a risk of collision with crossing traffic is detected when you are pulling away or driving at walking pace, three red arrows pointing in the direction of the crossing road user will light up one after the other on the driver display together with the distance warning lamp . If the situation is particularly critical, the arrows will begin to flash. A warning tone will also sound. If you do not react to the warning, acceleration may be restricted or autonomous braking may be initiated in critical

situations. Autonomous braking can also prevent the vehicle from pulling away and hold it at a standstill. In particularly critical situations, Active Brake Assist may also initiate autonomous braking directly. In this case, the  distance warning lamp and warning tone will occur at the same time as brake application.

If autonomous braking or situation-dependent brake force boosting has occurred, a pop-up will appear on the driver display and then automatically disappear after a short time.

If Active Brake Assist is set to **Late**, the purely visual warning level and restriction of acceleration will be deactivated. If the situation is particularly critical, it is still possible for a visual warning to be issued, a warning tone to be emitted and autonomous braking to be initiated.

Evasive Steering Assist

 **WARNING** Risk of accident despite Evasive Steering Assist

Evasive Steering Assist cannot always recognize objects or complex traffic situations clearly.

Moreover, the steering support provided by Evasive Steering Assist is not sufficient to avoid a collision.

- ▶ Always pay careful attention to the traffic situation; do not rely on Evasive Steering Assist alone.
- ▶ Be prepared to brake or swerve if necessary.
- ▶ End the support by actively steering in non-critical situations.
- ▶ Drive at an appropriate speed if there are pedestrians close to the path of your vehicle.

Evasive Steering Assist has the following features:

- Detection of pedestrians, cyclists and vehicles.
- Help through additional steering assistance if it detects an evasive maneuver.
- Activation by an abrupt steering movement during an evasive maneuver.
- Assistance in taking evasive action and straightening the vehicle.
- Reaction from a speed of approximately 12 mph (20 km/h) up to a speed of approximately 68 mph (110 km/h).

You can cancel steering assistance by Evasive Steering Assist at any time by countersteering.

System limits

Full system performance will not be available for a short time after you switch on the vehicle or drive off. As long as the functions are restricted, the  Active Brake Assist warning lamp may also be shown on the driver display. Depending on the environmental conditions, it may take a few minutes before full system performance is available.

The system may be impaired or may not function in the following situations in particular:

- In snow, rain, fog, heavy spray, glare, in direct sunlight or in greatly varying ambient light.
- If the sensors are dirty, fogged up, damaged or covered. (→ page 229)
- If the sensors are impaired owing to interference from other radar sources, e.g. intense radar reflections in parking garages.
- If a loss of tire pressure or a defective tire has been detected and displayed.
- In complex traffic situations where objects cannot always be clearly identified.
- If pedestrians, cyclists or vehicles move quickly into the sensor detection range.
- If road users are hidden by other objects or are located close to other objects.
- If the typical outline of a pedestrian or cyclist cannot be distinguished from the background.
- If a pedestrian or cyclist is not detected as such, e.g. owing to special clothing or other objects.

- If the driver's seat belt is not fastened.
- On tight bends.

■ Setting Active Brake Assist

Requirements

- The vehicle is switched on.

Multimedia system:

→  » Settings » Assistance
» Collision Avoidance

▶ Activate or deactivate the function.

- ⓘ Availability of the function is dependent on the respective country.
- ⓘ It is recommended that you always leave Active Brake Assist activated.

When switching off Active Brake Assist, the distance warning function, the collision warning, the autonomous braking function and the Active Evasive Steering Assist are switched off.

- ⓘ If Active Brake Assist is deactivated, the  symbol appears in the status bar of the driver display and when the vehicle is next started the system is activated again.

Setting warning timing

- ▶ Select  alongside **Active Brake Assist**.
- ▶ Select **Early**, **Medium** or **Late**.

Traffic Sign Assist

■ Function of Traffic Sign Assist

- ⓘ This function is an on-demand feature (→ page 24).

Traffic Sign Assist detects the traffic signs with the multifunction camera and compares them with the information from the digital road map of the navigation system. It assists you by displaying detected speed limits and overtaking restrictions on the driver display.

Speed limits can also be shown on the head-up display.

The system can issue a warning when you exceed the speed limit.

In some countries, the system can provide you with further functions and warn you when you are approaching pedestrian crossings or when you

are about to drive past stop signs or red lights unintentionally.

The camera also detects and analyzes traffic signs with a restriction indicated by an additional sign (e.g. in wet conditions).

Traffic Sign Assist shows only selected signs on the driver display. Actual traffic signs and speed limits have priority over traffic signs and speed limits shown on the driver display.

Observe the notes on driving systems and your responsibility; you may otherwise fail to recognize potential dangers (→ page 229).

Also observe the following information:

- select a speed adapted to the traffic, surroundings and weather conditions
- observe actual traffic signs
- observe applicable traffic rules and regulations

Observe the notes on driving systems and your responsibility; you may otherwise fail to recognize potential dangers (→ page 229).

Indicators on the driver display

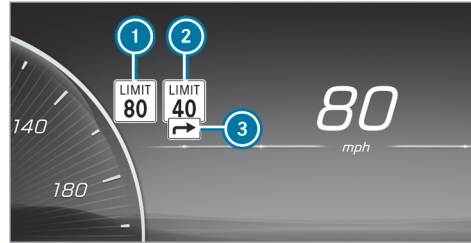

(Example)

- 1 Permissible speed
- 2 Permissible speed when there is a restriction
- 3 Additional sign with restriction

The system can show up to two traffic signs on the driver display simultaneously. The system will always prioritize displaying speed restrictions. No more than one traffic sign with a maximum permissible speed can be shown on the head-up display. If two speed signs are shown on the driver display, e.g. in the event of detected restrictions, the value of left-hand speed restriction 1 will

always be conveyed to the cruise control or Active Distance Assist DISTRONIC for acceptance and shown on the head-up display.

Important information from other systems may cause traffic signs to be hidden for a short time.

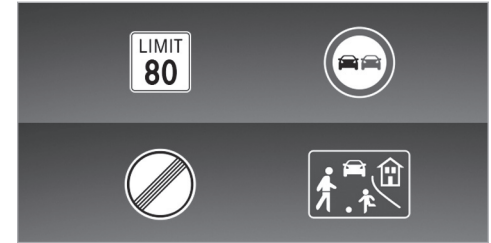

Examples of traffic signs that can be displayed

Traffic Sign Assist can detect and display the following traffic signs 1:

- speed restrictions
- end of the speed restriction
- overtaking restrictions
- play streets

- recommended speeds

Traffic Sign Assist can detect the following additional signs  and evaluate relevance of the restrictions as required using auxiliary vehicle sensors:

- in wet conditions
- slippery road surfaces
- in fog
- temporary restrictions
- exits

Traffic Sign Assist also uses data from the digital street map in the navigation system. When you pass a city or city boundary or move from one road onto another, e.g. when joining or exiting a freeway, or when turning at a crossroads, the view on the driver display can thus also be updated without a traffic sign having been detected.

 Regularly update the digital road map of the navigation system to enable Traffic Sign Assist to work optimally.

Depending on vehicle equipment and country, the system can also display speed limits ahead on the

driver display and head-up display. The driver display can also show the distance to an upcoming lower speed limit. Information from the digital road map of the navigation system is used for this purpose. The **Assistance** menu can also display a dynamic visualization of the speed limit ahead.

If the Traffic Sign Assist cannot determine the current maximum permissible speed, e.g. due to a lack of signage, the following indicator will appear on the driver display:



Traffic Sign Assist is not available in all countries. This display will be shown permanently in the vehicle when you are traveling in countries where Traffic Sign Assist is not supported.

If the system is temporarily or permanently unavailable due to a technical malfunction or dirt on the windshield, a corresponding display message will appear on the driver display. The Traffic Sign Assist  warning lamp will also light up on the driver display in certain countries.

 Please also note the information on the display messages from Traffic Sign Assist (→ page 449).

Warning when the maximum permissible speed is exceeded

The system can warn you if you are about to exceed the maximum permissible speed. Depending on the country, you can set in the multimedia system by how much the maximum permitted speed may be exceeded before a warning is given. You can switch off the warning or set whether the warning should be visual (by flashing the traffic sign on the driver's display) or visual and audible. Depending on the country, the selection of the type of warning will be confirmed by an indicator on the driver display.

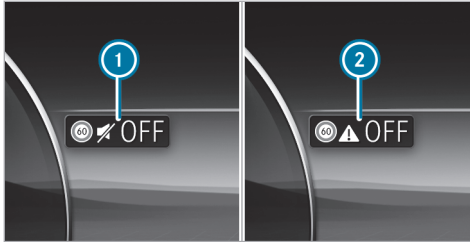

(Example)

- ① Visual warning only
- ② WARNING off

ⓘ The type, duration and deployment thresholds of the speed warning as well as the possibility of setting the deployment thresholds from which the warning is to be triggered are subject to the country-specific legislation of the country in which the vehicle is delivered.

Additional functions of Traffic Sign Assist (country-specific)

Warning for no-entry signs: Traffic Sign Assist can warn you if you drive the wrong way down a sec-

tion of road, such as on freeway on-ramps or one-way streets.

Warning at pedestrian crossings: if you are approaching a pedestrian crossing and pedestrians are in the danger zone or are moving towards it, Traffic Sign Assist can warn you up to a speed of approximately 44 mph (70 km/h).

Warning at stop signs: Traffic Sign Assist can warn you up to a speed of approximately 44 mph (70 km/h) if you are about to drive past a stop sign unintentionally. For this to be possible, the signs must be clear; for example, if the system detects more than one stop sign, or a stop sign is confirmed by the digital navigation map. No warning can be issued if several different signs are detected.

Warning at red lights: Traffic Sign Assist can warn you up to a speed of approximately 44 mph (70 km/h) if you are about to drive through a red light unintentionally.

The following conditions must be fulfilled:

- Several traffic lights have been detected.
- All traffic lights detected are red.

- At least one of the red traffic lights detected is on the front passenger side beside the vehicle's lane.
- The traffic lights are in the following sequence (from top to bottom): red, yellow and green.
- ⓘ Where available, you can turn the warnings on and off on the Traffic Sign Assist menu under **Further Warnings**(→ page 264).

System limits

The system may be impaired or inoperative in the following situations in particular:

- If visibility is poor, e.g. due to insufficient illumination of the road, highly variable shade conditions, rain, snow, fog, swirling dust or heavy spray.
- if there is glare, e.g. from oncoming traffic, direct sunlight or reflections.
- If there is dirt on the windshield in the vicinity of the multifunction camera or if the camera is fogged up, damaged or obscured.
- If the traffic signs are difficult to see because, for example, they are dirty, obscured, faded,

iced over, damaged, inconveniently positioned, insufficiently illuminated or twisted.

- Active traffic signs with LED displays may not be detected correctly or at all due to technical factors, such as transmission frequency.
- If the information on the navigation system's digital map is incorrect, incomplete or out of date.
- If the signs, road markings or road layout are ambiguous, e.g. in the case of traffic signs at road work sites, at on-ramps and off-ramps, in the case of adjacent lanes or parallel roads or where there are pedestrian crossing markings at traffic lights.
- If the signage or road markings do not comply with the standard.
- If the signage, road markings or road guidance is country-specific and deviates from the route guidance of the navigation system, e.g. at or after road work sites.
- After sharp turns and tight bends, if traffic signs are outside the camera's field of vision.

- If you overtake vehicles with traffic signs attached to them.

■ Setting Traffic Sign Assist

Multimedia system:

- 

 >> Settings >> Assistance
 >> Assistance >> Traffic Sign Assist

Activating/deactivating the speed limit warning

- ▶ Switch off **Speed Limit Warning**.
The speed limit warning will remain off according to country-specific legislation until the next time the vehicle is switched on or off and the driver's door is opened.

Change the type of speed limit warning

- ▶ Change the warning to **Visual only** or **Visual and audible**.

Setting the warning threshold

This value determines the speed above which a warning will be issued.

- ▶ Set the desired speed under Warning Threshold.

Activating/deactivating additional functions of Traffic Sign Assist

- ▶ Activate or deactivate **Further Warnings**.
The available functions will be switched on or off.

Set the type of warning for other functions

- ▶ Select **Visual only** or **Visual and audible**.

Blind Spot Assist and Active Blind Spot Assist

■ Function of Blind Spot Assist and Active Blind Spot Assist with exit warning

Blind Spot Assist and Active Blind Spot Assist use radar sensors to monitor the area up to 130 ft (40 m) behind and 10 ft (3 m) next to your vehicle.

The system can detect vehicles traveling from speeds of approximately 8 mph (12 km/h) and issue a warning if they move into the monitoring range.

Status indicator on the driver display



Gray: the system is activated but inoperative.



Green: the system is activated and operational.

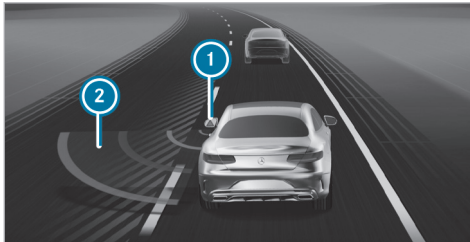

Indicator on the **Assistance** menu on the driver display

- ① Warning lamp on the exterior mirror
- ② Red radar waves

If a vehicle is detected from approximately 8 mph (12 km/h) and immediately moves into the monitoring range, the warning lamp on the relevant exterior mirror will light up red. On the **Assistance** menu, the lamp on the exterior mirror ① will also light up red, and the lane in which the vehicle is detected will be hatched out.

If a vehicle is detected in the monitoring range and you activate the direction indicators in the corresponding direction, a double warning tone will sound once and the warning lamp will flash red on the corresponding exterior mirror. Red radar waves ② will be displayed next to your vehicle on the assistant display.

If the turn signal indicator remains on, the indicator on the exterior mirror will flash for all other detected vehicles, but no further warning tone will sound. If you overtake a vehicle quickly, no warning will be issued.

i **Vehicles with active ambient lighting:** if **Warning Support** is activated, the warning will also be highlighted by the ambient lighting (→ page 151).

Observe the notes on driving systems and your responsibility; you may otherwise fail to recognize potential dangers (→ page 229).

⚠ WARNING Risk of accident despite Blind Spot Assist

Blind Spot Assist does not react to vehicles approaching and overtaking you at a greatly different speed.

Blind Spot Assist cannot warn drivers in this situation.

- ▶ Always pay careful attention to the traffic situation and maintain a safe distance at the side of the vehicle.

⚠ WARNING Risk of accident despite Active Blind Spot Assist

Active Blind Spot Assist does not react to the following:

- if you overtake a vehicle too closely so that it is in the blind spot area
- if vehicles traveling at a much faster speed approach and then overtake

Active Blind Spot Assist may not give warnings or intervene in such situations.

- ▶ Always pay careful attention to the traffic situation and maintain a safe distance at the side of the vehicle.

Exit warning

The exit warning is an additional function of Blind Spot Assist and Active Blind Spot Assist and can warn vehicle occupants attempting to leave a stationary vehicle about approaching vehicles.

⚠ WARNING Risk of accident despite exit warning

The exit warning neither reacts to stationary objects nor to persons or road users approaching you at a greatly differing speed.

The exit warning cannot warn drivers in these situations.

- ▶ Always pay particular attention to the traffic situation when opening the doors and make sure there is sufficient clearance.

If a vehicle is detected in the monitoring range, the red warning lamp will light up on the corresponding exterior mirror.

If a vehicle occupant pulls the door handle on the side of the warning, a warning tone will sound twice and the ambient lighting on the respective door and the warning lamps on the corresponding exterior mirror will flash red.

Vehicles with MBUX Interior Assistant: the visual warning will begin as soon as the hand of a vehicle occupant moves into the area of the door.

- ① **Vehicles with ambient lighting or active ambient lighting:** the **Warning Support** provided by the ambient lighting can be activated and deactivated (→ page 151).
- ① The warning assistance may vary depending on the equipment and setting.

The exit warning is available only when Blind Spot Assist or Active Blind Spot Assist is active.

After the vehicle is switched off, the exit warning will continue to function for a few minutes. If a door is opened when the vehicle is switched off, the exit warning will be active again for a few minutes. When the exterior mirror warning lamp

flashes three times, the exit warning is no longer available.

The exit warning is only an aid and not a substitute for the attention of vehicle occupants. The responsibility for opening and closing the doors and for leaving the vehicle remains with the vehicle occupants.

System limits

Blind Spot Assist and Active Blind Spot Assist may be limited in the following situations in particular:

- if there is dirt on the sensors or the sensors are obscured
- in poor visibility, e.g. owing to fog, heavy rain or snow
- if there are narrow vehicles, e.g. bicycles or motorcycles
- if the road has very wide or narrow lanes
- if vehicles are not driving in the middle of their lanes

Warnings may be issued in error when you drive close to crash barriers or similar structural lane borders. Always ensure that there is a sufficient

distance at the sides to other road users or obstacles.

Warnings may be interrupted when you drive alongside long vehicles, such as trucks, for a prolonged time.

Blind Spot Assist and Active Blind Spot Assist will not be operational when reverse gear is engaged.

Additionally, the exit warning may be limited in the following situations:

- when the sensor is blocked by adjacent vehicles in narrow parking spaces
- when people are approaching
- in the case of stationary or slow-moving objects

■ Brake application function in Active Blind Spot Assist

i The brake application function is only available for vehicles with Driving Assistance Package.

If Active Blind Spot Assist detects a risk of a side impact in the monitored range, a course-correcting brake application is carried out. Course-

correcting brake application helps in this case to avoid collision with another vehicle.

The course-correcting brake application is available to you from a speed of approx. 20 mph (30 km/h) - 17 mph (60 km/h) (depending on the country) up to a speed of approx. 125 mph (200 km/h).

⚠ WARNING Risk of accident despite brake application of Active Blind Spot Assist

A course-correcting brake application cannot always prevent a collision.

- ▶ Always steer, brake or accelerate yourself, especially if Active Blind Spot Assist warns you or makes a course-correcting brake application.
- ▶ Always maintain a safe distance at the sides.



If a course-correcting brake application occurs, the red warning lamp flashes in the outside mirror and a warning tone sounds. In addition, a display **i** indicating the danger of a side collision appears on the driver display.

In rare cases, the system may make an inappropriate brake application. This brake application may be interrupted at any time if you steer slightly in the opposite direction or accelerate.

System limits

Note the system limitations of Active Blind Spot Assist; you may otherwise not recognize the dangers (→ page 264).

Either a course-correcting brake application appropriate to the driving situation, or none at all, may occur in the following situations in particular:

- Vehicles or obstacles, e.g. crash barriers, are located on both sides of your vehicle.
- An approaching vehicle leaves too little lateral distance between you.
- You have adopted a sporty driving style with high cornering speeds.
- You brake or accelerate significantly.
- A driving safety system intervenes, e.g. ESP® or Active Brake Assist.
- ESP® is deactivated.
- A loss of tire pressure or a defective tire is detected.

■ Switching Blind Spot Assist or Active Blind Spot Assist on or off

Multimedia system:

→  >> Settings >> Assistance
>> Collision Avoidance

- ▶ Activate or deactivate **Active Blind Spot Assist**.

Active Lane Keeping Assist

■ Function of Active Lane Keeping Assist

Active Lane Keeping Assist monitors the area in front of your vehicle by means of a multifunction camera, (→ page 229) and can protect you from departing your lane unintentionally. The system can guide you back into your lane with a course-correcting steering intervention, and warn you with tangible steering wheel feedback.

Active Lane Keeping Assist is available in the speed range between 37 mph (60 km/h) and 124 mph (200 km/h).

The system may intervene in the following situations:

- Active Lane Keeping Assist detects a lane marking.
- You touch this lane marking with one of your front wheels.

If you activate the turn signal indicator, no steering intervention will occur on the corresponding side.

No steering intervention will occur if you depart your lane without activating a direction indicator but there is a risk of collision with a moving obstacle in your own lane.

Vehicles with Blind Spot Assist or Driving Assistance Package: If the system detects an obstacle, e.g. another vehicle, in the adjacent lane, steering intervention will occur even if you have activated a turn signal indicator.



In the following cases, warning ① will appear on the driver display and a warning tone will sound:

- A steering intervention by Active Lane Keeping Assist lasts more than approximately ten seconds.
- The system carries out two or more steering interventions within approximately three minutes without any steering intervention from the driver.

You can set the sensitivity of the system in the Active Lane Keeping Assist settings in order to determine the level of assistance. You can also determine whether the system is to react to bro-

ken lane markings, or only to continuous lane markings (→ page 271).

If ATTENTION ASSIST has detected signs of drowsiness, the most sensitive setting will automatically be selected (→ page 235).

Status indicators of Active Lane Keeping Assist



White: Active Lane Keeping Assist is switched off.

If ESP® is switched off or a tire pressure loss warning is indicated, Active Lane Keeping Assist will automatically be switched off.



Yellow: There is a malfunction. Also note any display messages.



Gray: Active Lane Keeping Assist is switched on but not ready.



Green: Active Lane Keeping Assist is switched on and ready. If the system is ready only on one side, only the lane marking on that side will be shown in green.



Red: Active Lane Keeping Assist has guided you back into your lane by course-correcting steering intervention. If a haptic

warning is also given through the steering wheel, the status indicator will flash. The lane marking of the affected side will be shown in red.

Vehicles without Driving Assistance Package: If both lane markings are shown in red on the status display at the same time, Active Lane Keeping Assist has initiated an emergency stop (→ page 248).



Indicator on the [Assistance](#) menu on the driver display

If one of your front wheels moves onto a detected lane marking, this will be highlighted in red on the **Assistance** menu on the driver display.

i **Vehicles with active ambient lighting:** If **Warning Support** is switched on, the Active Lane Keeping Assist warning will be reinforced by the ambient lighting (→ page 151).

System limits

In the following situations, there may be no course-correcting steering intervention but a warning may be issued through the steering wheel depending on the situation:

- if you clearly and actively steer, brake or accelerate.
- if a driving safety system is intervening, e.g. ESP® or Active Brake Assist
- if you have adopted a sporty driving style with high cornering speeds or high rates of acceleration

The system may be impaired or inoperative in the following situations in particular:

- if there is poor visibility, e.g. owing to insufficient road illumination, highly variable shadows, rain, snow, fog or heavy spray
- if there is glare, e.g. from oncoming traffic, direct sunlight or reflections
- if there is dirt on the windshield in the vicinity of the multifunction camera, or if the camera is fogged up, damaged or obscured
- if the bumper is dirty in the area of the radar sensors, or if these are damaged or obscured
- if there are no lane markings, or several unclear lane markings are present for one lane, e.g. around road work sites
- if the lane markings are worn, dark or covered
- if the distance to the vehicle in front is too short and the lane markings therefore cannot be detected
- if the lane markings change quickly, e.g. lanes branch off, cross one another or merge
- if the lanes are very narrow and winding

Observe the notes on driving systems and your responsibility; you may otherwise fail to recognize potential dangers (→ page 229).

■ Activating/deactivating Active Lane Keeping Assist

Multimedia system:

→  **» Settings » Assistance**
» Collision Avoidance
» Active Lane Keeping Assist

 Activate or deactivate the function.

Alternatively, Active Lane Keeping Assist can be activated and deactivated via quick-access.

i The settings after the vehicle is started are country-specific.

Setting Active Lane Keeping Assist

Multimedia system:

-  » Settings » Assistance
- » Collision Avoidance
- » Active Lane Keeping Assist

Setting the sensitivity

- ▶ Select .
- ▶ Select **Early**, **Med.** or **Late**.

The setting last selected is adopted when the vehicle is next started.

- ⓘ The standard setting of this function is country-dependent.

Activating/deactivating assistance when lane markings are interrupted

- ▶ Select **Advanced Support**.

The setting last selected is adopted when the vehicle is next started.

- ⓘ The standard setting of this function is country-dependent.

- ⓘ This function must be activated for vehicles without Driving Assistance Package for Emergency Stop Assist to be available in full measure. Further information on Emergency Stop Assist (→ page 248).

Rear view camera

Function of the rear-view camera

The rear-view camera serves solely as an aid. It is not a substitute for you having to pay attention to your surroundings. The responsibility for safe maneuvering and parking remains with you. Ensure that no persons, animals, objects, etc. are in the maneuvering area while maneuvering and parking.

- ⓘ The area behind the vehicle is displayed as a mirror image, as it would appear in the inside mirror.

Vehicles with Parking Package

The following camera perspectives are available on the central display:

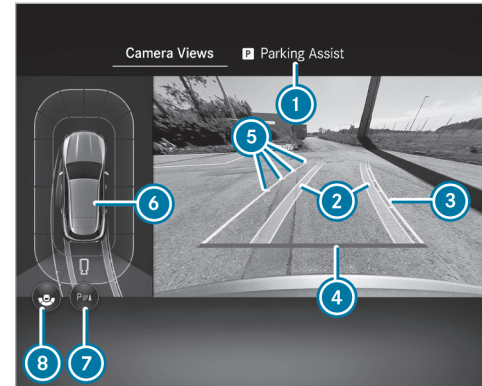

Menu **Camera Views** (top view)

- ① Menu **Parking Assistance**
- ② Path indicating the route the wheels will take at the current steering angle (dynamic)
- ③ Driven surface depending on the current steering angle (dynamic)
- ④ Guide line at a distance of approximately 1.0 ft (0.3 m) from the rear area

- 5 Guide lines at a distance of approximately 1.6 ft (0.5 m), 3.3 ft (1.0 m), 5 ft (1.5 m) and 9.9 ft (3.0 m) from the rear area
- 6 Warning display of Parking Assist PARKTRONIC (→ page 277)
- 7 Activating/deactivating Parking Assist PARKTRONIC (→ page 280)
- 8 Switching wide-angle view to rear-view camera with top view
- i When Active Parking Assist is active, the paths 2 are displayed in green (→ page 281).



Wide-angle view (example)

- 6 Warning display of Parking Assist PARKTRONIC (→ page 277)
- 7 Activating/deactivating Parking Assist PARKTRONIC (→ page 280)
- 10 Switching wide-angle view to standard view

System limits

If the system is not ready for operation, the message **System Inoperative** appears on the driver display and/or on the central display.

If a camera perspective is selected and the central display is temporarily black or does not show a camera image, the camera system is also faulty or is not ready for operation.

The rear-view camera will not function or will function only partially in the following situations:

- You are driving forwards at a speed greater than approximately 10 mph (16 km/h).
- The trunk lid is open.
- The weather conditions are poor, e.g. heavy rain, snow, fog, storm or spray.
- The ambient light is poor, e.g. at night or if a light is shining into the camera.
- The camera lens is obstructed, dirty or fogged up. Observe the notes on cleaning the rear-view camera (→ page 375).
- The camera or rear of your vehicle is damaged. In this case, have the camera, its posi-

tion and setting checked at a qualified specialist workshop.

- ❗ Do not use the rear-view camera in these types of situations. You could otherwise injure others or collide with objects when parking the vehicle.

The field of vision and other functions of the camera system may be restricted due to additional vehicle attachments (e.g. license plate bracket or bicycle rack).

- ❗ The contrast of the display may be impaired by direct sunlight or by other light sources, e.g. when you are driving out of a garage. Particular attention must be afforded in this case.
- ❗ Have the display repaired or replaced if, foreexample, its use is considerably restricted due to pixel errors.

Observe also the information on vehicle sensors and cameras (→ page 229).

360° camera

Function of the 360° camera

The 360° camera is a system comprising four cameras that cover the immediate vehicle surroundings. The cameras support you, for example, when parking or when exits are difficult to see.

The 360° camera includes the following cameras and evaluates their images:

- Rear-view camera
- Front camera
- Two outside mirror cameras

The cameras serve solely as aids and may show a distorted view of obstacles, show them incorrectly or even omit them altogether. They are not a substitute for you having to pay attention to your surroundings. The responsibility for safe maneuvering and parking remains with you. Ensure that no persons, animals, objects, etc. are located in the maneuvering area while you are maneuvering and parking.

The following camera perspectives are available on the central display:

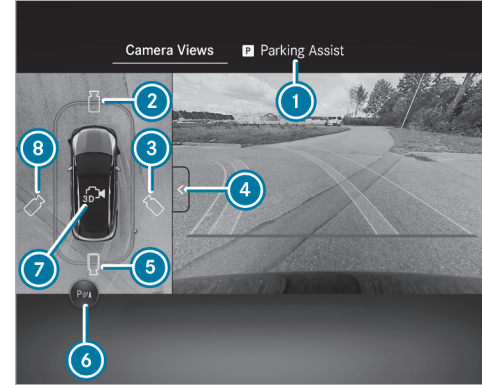

Overview of **Camera Views** menu (example)

- ① Menu **Parking Assistance**
- ② Top view with image from the front camera
- ③ 3D view right-hand side of the vehicle
- ④ Switching between standard view and wide-angle view
- ⑤ Rear-view camera
- ⑥ Activating/deactivating Parking Assist PARKTRONIC (→ page 280)

- ⑦ 3D auto view
- ⑧ 3D view left-hand side of the vehicle
- i The warning display of Parking Assist PARKTRONIC is shown in all views (→ page 277).
- i Availability of the ③, ⑧ 3D view and ⑦ 3D auto view functions is dependent upon the respective vehicle equipment.

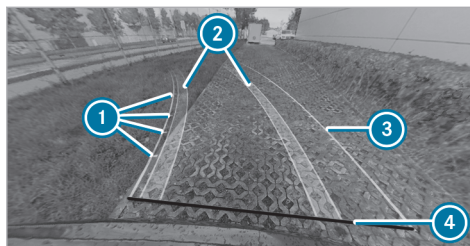

Function of the guide lines (example)

- ① Guide lines at a distance of approximately 1.6 ft (0.5 m), 3.3 ft (1.0 m), 5 ft (1.5 m) and 9.9 ft (3.0 m) from the rear area
- ② Path indicating the route the wheels will take at the current steering angle (dynamic)
- ③ Driven surface depending on the current steering angle (dynamic)
- ④ Guide line at a distance of approximately 1.0 ft (0.3 m) from the rear area
- i When Active Parking Assist is active, paths and guide lines are displayed in green instead of yellow (→ page 281).

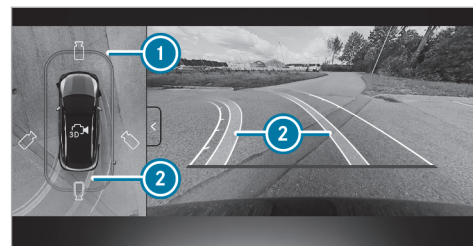

Top view with image of front camera or rear-view camera (example)

- ① Warning display of Parking Assist PARKTRONIC (→ page 277)
- ② Path indicating the current steering angle

⚠ WARNING Risk of accidents due to objects not being displayed or being displayed in a distorted manner

Due to the projection of the cameras, objects in the 3D views may be strongly distorted or not displayed at all.

- ▶ Make sure that there are no persons, animals or objects etc., in the maneuvering area while maneuvering and parking.



3D view left/right-hand side of the vehicle (example)

- ① Warning display of Parking Assist PARKTRONIC (→ page 277)
- ② Switching between 3D view and 2D view

In the 3D view, left/right-hand side of the vehicle, the virtual camera moves to the respective side of the vehicle. When you change the transmission position, the view is automatically adapted.

- ① Display of the area beneath the vehicle may deviate from the actual circumstances.

- ① The area behind the vehicle is **not** displayed as a conventional mirror image in the 3D views.

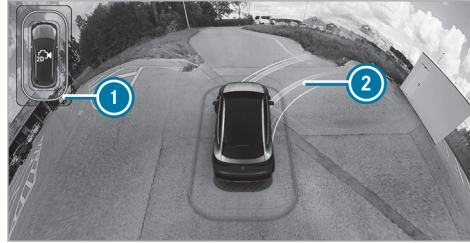

3D auto view (example)

- ① Display of Parking Assist PARKTRONIC (→ page 277)
- ② Guide lines

In the 3D auto view, the virtual camera moves to the standard view, facing forward from the rear above the roof. The view changes automatically when approaching obstacles.

If you touch the touchscreen, the view changes to a 3D view with free rotation. You can turn, tilt and zoom the views by touch.

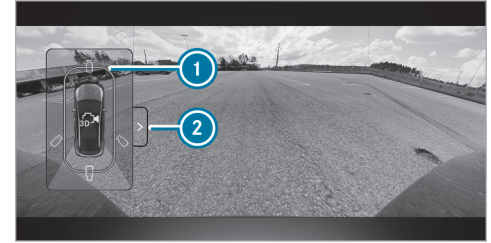

Wide-angle view (example)

- ① Display of Parking Assist PARKTRONIC (→ page 277)
- ② Switching between standard view and wide-angle view

System limits

If the system is not ready for operation, the **System Inoperative** message appears on the driver display and/or on the central display.

If a camera perspective is selected and the central display is temporarily black or does not show a camera image, the camera system is also faulty or is not ready for operation.

⚠ WARNING Risk of accident due to restrictions in the function of the 360° camera

If the function of the 360° camera is restricted, there is a risk of collision with people or objects.

- ▶ Do not use the 360° camera in the event of function restrictions.
- ▶ Make sure that there are no persons, animals or objects etc., in the maneuvering area while maneuvering and parking.

The 360° camera will not function or will function only partially in the following situations, for example:

- You are driving forwards at a speed greater than approximately 10 mph (16 km/h).
- The doors are open.
- An outside mirror is not completely extended.

- The trunk lid is open.
- The weather conditions are poor, e.g. heavy rain, snow, fog, storm or spray.
- The ambient light is poor, e.g. at night or if a light is shining into the camera.
- The camera lens is obstructed, dirty or fogged up. Refer to the notes on cleaning the 360° camera (→ page 375).
- If cameras or vehicle components in which the cameras are installed are damaged. In this event, have the cameras, their positions and their setting checked at a qualified specialist workshop.

For technical reasons, the standard height of the vehicle may be altered if the vehicle is carrying a heavy load and can result in inaccuracies in the guide lines and in the display of generated images.

The field of vision and other functions of the camera system may be restricted due to additional vehicle attachments (e.g. license plate bracket or bicycle rack).

- ⓘ Contrast of the display may be impaired by abrupt direct sunlight or other light sources, e.g. when driving out of a garage. Particular attention must be afforded in this case.
- ⓘ Have the display repaired or replaced if, for example, its use is considerably restricted due to pixel errors.

Observe also the information on vehicle sensors and cameras (→ page 229).

■ Calling up the 360° camera views using the button

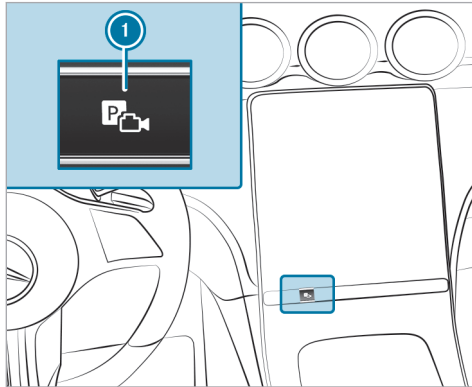

- ▶ Press button ①.
- ▶ Select **Camera Views** menu.
- ▶ Select the desired view in the multimedia system (→ page 273).

■ Selecting a view for the 360° camera (reverse gear)

- ▶ Engage reverse gear.
- ▶ Select the desired view in the multimedia system (→ page 273).

■ Opening the camera cover

Multimedia system:

- ▶ Settings ▶ Assistance
- ▶▶ Camera

- ▶ Select **Open Camera Cover**.

- ① The camera cover will close automatically after some time or after the vehicle is switched on or off.

Parking Assist PARKTRONIC

■ Function of Parking Assist PARKTRONIC

Parking Assist PARKTRONIC is an electronic parking assistance system that monitors the area surrounding your vehicle. The distance between your vehicle and a detected obstacle is displayed visually and acoustically.

The passive side impact protection also warns you of obstacles to the side. These must be detected beforehand by the sensors in the front or rear bumper while you are driving past them. If you steer in the direction of a detected obstacle and there is a risk of a lateral collision, a warning is issued.

Passive side impact protection can be activated and deactivated via the multimedia system (→ page 281).

In order that front or rear obstacles to the side can be displayed, the vehicle must first travel a distance of at least half a vehicle length. Once the vehicle has traveled a distance of one vehicle length, obstacles on all sides can be shown.

Parking Assist PARKTRONIC serves solely as an aid. It is not a substitute for you having to pay attention to your surroundings. The responsibility for safe maneuvering, parking and exiting parking spaces remains with you. Ensure that no persons, animals, objects, etc. are in the maneuvering area while maneuvering and parking in/exiting parking spaces.

Displays on the central display

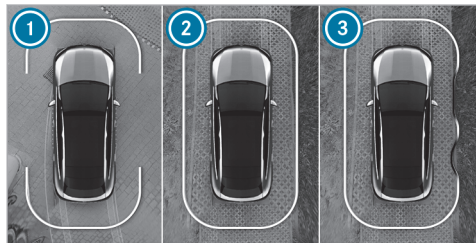

Example: vehicles with 360° camera

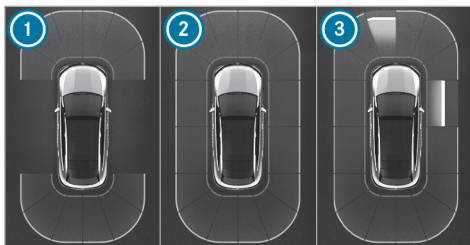

Example: vehicles with rear-view camera

- ① Ready for display at the front and rear
- ② Ready for display all around
- ③ Ready for display all around and obstacles detected

As soon as Parking Assist PARKTRONIC is ready for display, the respective areas ① to ③ of the display are shown in blue.

The color of the display changes depending on the distance to the detected obstacle:

- **Blue:** > 3.3 ft (1 m) (no obstacles detected)
- **Yellow:** approximately 3.3 ft (1 m) - 2.3 ft (0.7 m)

- **Orange:** approximately 2.3 ft (0.7 m) - 1.3 ft (0.4 m)
- **Red:** < 1.3 ft (0.4 m)

Vehicles with 360° camera: the boundary line shifts dynamically depending on the position and distance of the obstacles detected.

An intermittent warning tone also sounds depending on the distance to the obstacle detected. You can set the timing of the warnings in the multimedia system. In the **Warn Early** setting, the system warns you from a distance of 3.3 ft (1 m). In the standard setting, from a shorter distance of 1.3 ft (0.4 m).



Example: vehicles with 360° camera

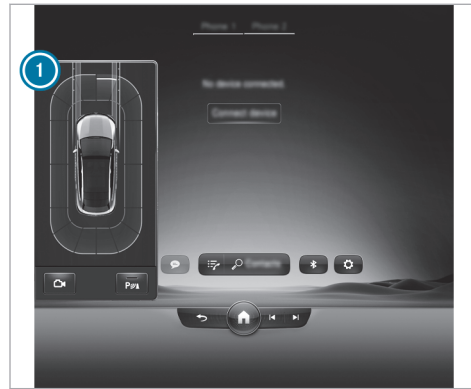

Example: vehicles with rear-view camera

If you are not in the [Camera & Parking](#) menu and an obstacle in the vehicle's path is detected, a pop-up window ① appears on the central display if the following requirements are met:

- **Vehicles without Active Parking Assist:** when you are driving no faster than 8 mph (12 km/h).

- **Vehicles with Active Parking Assist:** when you are driving no faster than 11 mph (18 km/h).

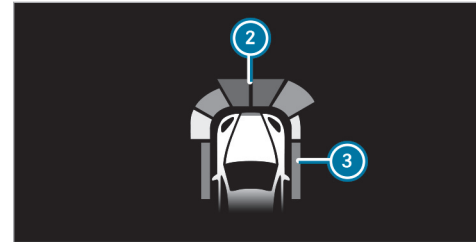

Head-up display (example)

Optionally, obstacles detected by Parking Assist PARKTRONIC from a distance of approximately 3.3 ft (1.0 m) in front ② and 2.3 ft (0.7 m) at the sides ③ can also be displayed on the head-up display.

System limits

Parking Assist PARKTRONIC does not necessarily take into account the following obstacles:

- Obstacles below the detection range, e.g. persons, animals or objects
- Obstacles above the detection range, e.g. protruding loads, overhangs or loading ramps of trucks
- Pedestrians or animals approaching the vehicle from the side
- Objects placed next to the vehicle

Obstacles on the sides are not shown in the following situations, for example:

- You park the vehicle and switch it off.
- You open the doors.

After the vehicle is restarted, obstacles must be detected again by driving past them before a new warning can be issued.

Observe also the system limits of the following systems:

- Rear-view camera (→ page 271)

- 360° camera (→ page 273)

Observe the information on vehicle sensors and cameras; otherwise the system cannot function properly (→ page 229).

Problems with Parking Assist PARKTRONIC

If the Parking Assist PARKTRONIC display lights up red for approximately three seconds and then goes out, and the  symbol appears on the driver display, the system may have been deactivated due to signal interference. Start the vehicle again and check whether Parking Assist PARKTRONIC works in a different location.

If a warning tone also sounds, the causes may be as follows:

- **The sensors are dirty:** clean the sensors (→ page 375).
- **Parking Assist PARKTRONIC has been deactivated due to a malfunction:** restart the vehicle. If the problem persists, consult a qualified specialist workshop.

Activating/deactivating Parking Assist PARKTRONIC

 **NOTE** Vehicle damage during parking or maneuvering due to objects at close range

Parking Assist PARKTRONIC may not detect certain objects close to the vehicle.

 When parking or maneuvering, look out in particular for objects that are underneath or above the sensors, e.g. flower pots or drawbars. Otherwise, the vehicle or other objects could be damaged.

Requirements

- The camera menu is open.
- Or: the Parking Assist PARKTRONIC pop-up window is displayed.

 Tap  on the central display.

If the indicator lamp is lit, Parking Assist PARKTRONIC is active. If the indicator lamp does not light up or the  symbol is displayed, Parking Assist PARKTRONIC is not active.

- ❗ Parking Assist PARKTRONIC will be activated automatically when the vehicle is started.

Alternatively, Parking Assist PARKTRONIC can be activated or deactivated on the quick-access menu.

■ Setting the warning tones for Parking Assist PARKTRONIC

Multimedia system:

- ➔  ➔ Settings ➔ Assistance
- ➔ Parking ➔ PARKTRONIC

Setting warning tones

- ▶ Select **Set Warning Tones**.
- ▶ Set the desired level under **Volume** or **Tone Pitch**.

Activating/deactivating audio fadeout

- ▶ Select **Audio Fadeout** and activate or deactivate **Audio Fade for Warnings**.
The volume of the media source currently playing will be reduced when a warning tone sounds in Parking Assist PARKTRONIC.

or

- ▶ Select **Audio Fadeout** and switch **Audio Fadeout When in R** on or off.
The volume of the media source currently playing will be reduced when reverse gear is engaged.

Setting warning timing

- ▶ Select **Time of Warning**.
- ▶ Set the desired warning time for **Front** or **Rear**.
- ▶ Activate or deactivate **Side Warning**.

Active Parking Assist

■ Function of Active Parking Assist

Active Parking Assist is an electronic parking assistance system that uses ultrasound with the assistance of the rear-view camera or 360° camera. When you are driving forwards up to approximately 22 mph (35 km/h), the system automatically measures parking spaces on both sides of the vehicle.

Active Parking Assist serves solely as an aid. It is not a substitute for you having to pay attention to

your surroundings. The responsibility for safe maneuvering, parking and exiting parking spaces remains with you. Ensure that no persons, animals or objects etc. are in the vehicle's path.

Active Parking Assist offers the following functions:

Vehicles with rear-view camera

- Parking in parking spaces parallel to the roadway
- Backing up into parking spaces perpendicular to the roadway



The parking space is freely selectable. The parking procedure is executed with the vehicle backing up.

Vehicles with 360° camera

- Parking in parking spaces parallel to the roadway
- Parking in parking spaces perpendicular to the roadway (either forwards or backing up as desired)

- Parking in parking spaces that can be detected as such only from markings (for example at the roadside)
- Exiting parking spaces if you have parked using Active Parking Assist



The parking space is freely selectable. The parking direction (forwards or backing up) can also be freely selected, depending on the orientation of the parking space.

If Active Parking Assist is available, the notification  appears on the driver display. When the system detects parking spaces, the notification  appears. The arrows show the side of the roadway on which free parking spaces are located. These are then shown on the central display.

When Active Parking Assist is activated, the turn signal indicators are activated based on the calculated path of your vehicle. The parking and unparking procedures are assisted by acceleration, braking, steering and gear changes.

To start the parking procedure, press the button  (→ page 283) or go to the navigation view (e.g. when near the destination) and select **Active Parking Assist** (→ page 305).

Active Parking Assist will be canceled in the following situations:

- You press the button  again.
- You begin steering.
- You select the park position .
- You engage the electric parking brake.
- ESP® intervenes.
- You open the driver's door.

System limits

If the exterior lighting is malfunctioning, Active Parking Assist is not available.

Observe also the system limits of the following systems:

- Rear-view camera (→ page 271)
- 360° camera (→ page 273)

Objects above or below the detection range of Active Parking Assist, e.g. protruding loads, overhangs or loading ramps of trucks or parking space boundaries are not detected when measuring the parking space. These are also not subsequently taken into account when calculating the parking

procedure. In some circumstances, Active Parking Assist may therefore prematurely guide you into the parking space or brake too late.

Certain environmental conditions, such as snowfall or heavy rain, may lead to a parking space being mismeasured. Parking spaces that are partially occupied by trailer drawbars might not be identified as such or may be measured incorrectly. Use Active Parking Assist only on level road surfaces with adequate grip.

⚠ WARNING Risk of accident due to objects located above or below the detection range of Active Parking Assist

If there are objects above or below the detection range, the following situations may arise:

- Active Parking Assist may steer too early.
- The vehicle may not stop in front of these objects.

There is a danger of collision!

- ▶ In these situations, do not use Active Parking Assist.

Active Parking Assist can also display unsuitable parking spaces, e.g. parking spaces in which parking is not permitted or on unsuitable surfaces.

Do not use Active Parking Assist in the following situations, for example:

- In extreme weather conditions, such as ice, packed snow or in heavy rain.
- When transporting a load that protrudes beyond the vehicle.
- If the parking space is on a steep downhill or uphill gradient.
- When snow chains are installed.
- Directly after a tire change or when spare tires are installed.
- If the tire pressure is too low or too high.
- On steep downhill gradients of more than approximately 15%.
- If the vehicle level has been offset, e.g. mounting the curb on one side (vehicles with level control)

Parking with Active Parking Assist

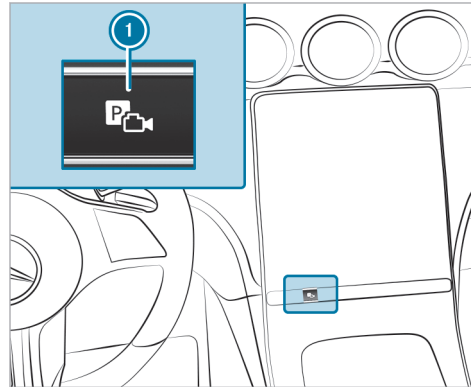

▶ Press the button ①.

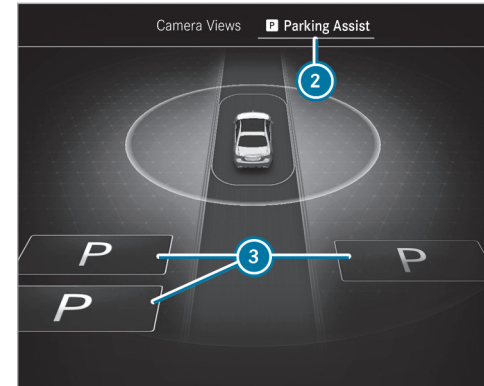

Parking Assist menu (example for left side of the screen)

▶ Select the **Parking Assistance** ② menu.

Parking spaces ③ detected by the system are shown on the central display.

At speeds greater than approx. 10 mph (16 km/h), the camera perspective on the right side of the screen switches off.

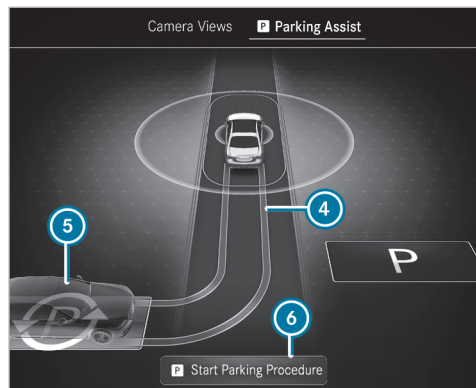

Parking Assistance menu (example)

When the vehicle is at a standstill, the indicated vehicle path ④ into the currently selected parking space ⑤ also appears.

- ▶ If a parking space is displayed: stop the vehicle.
- ▶ If necessary, select another parking space.

- ▶ **Vehicles with 360° camera:** to change the parking direction, tap the selected parking space again.
- ▶ **To start the parking procedure:** press the button ① again.

or

- ▶ Depress the brake pedal and select **Start Parking Procedure** ⑥ (depending on the respective vehicle equipment).
 - ▶ Take your hands off the steering wheel. The vehicle drives into the selected parking space.
- The duration of the parking procedure is indicated by a progress bar.

The turn signal indicator is switched on automatically when the parking procedure begins. You are responsible for selecting the turn signal indicator in accordance with the traffic conditions. If necessary, select the turn signal indicator accordingly.

⚠ WARNING Risk of accident due to vehicle swinging out while parking or pulling out of a parking space

While parking or exiting a parking space, the vehicle swings out and can drive onto areas of the oncoming lane.

This could cause you to collide with objects or other road users.

- ▶ Pay attention to objects and other road users.
- ▶ Where necessary, stop the vehicle or cancel the parking procedure with Active Parking Assist.

Following completion of the parking procedure, the **Active Parking Assist Finished** message appears.

- ▶ Secure the vehicle against rolling away. When necessitated by legal requirements or local conditions: turn the wheels towards the curb.

- ❗ You can stop the vehicle and change the transmission position during the parking procedure. The system then calculates a new vehicle path. If no new vehicle path is available, the transmission position can be changed again, or the process can be canceled.



Immediate parking via the **Camera Views** menu

- ▶ Select the **Camera Views** menu.
- ▶ When the vehicle is stationary and in transmission position **[R]**, and the symbol **7** appears in the camera image: press the button **1** again.
The parking procedure is initiated for the detected parking space.

- ❗ The parking space and parking direction cannot be changed in immediate parking.

■ Exiting a parking space with Active Parking Assist

Requirements:

- The vehicle is equipped with a 360° camera.
 - The vehicle has been parked with Active Parking Assist.
- ▶ Start the vehicle.

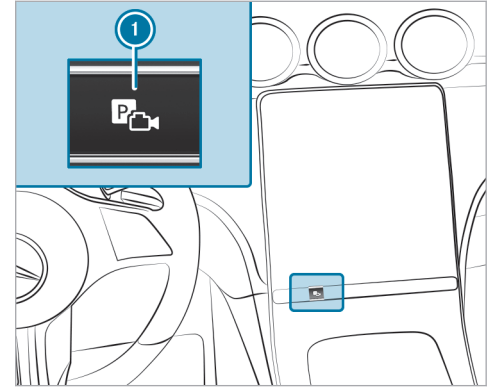

- ▶ Press the button **1**.

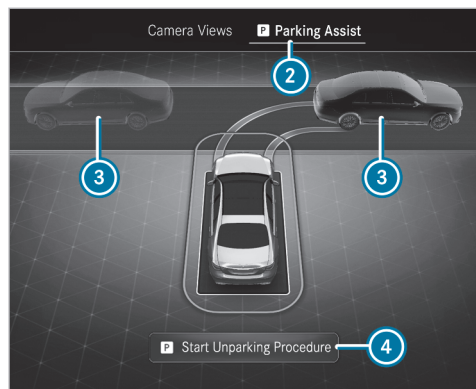

Parking Assist menu (example for left side of the screen)

- ▶ Select the **Parking Assistance** ② menu.

At speeds greater than approx. 10 mph (16 km/h), the camera perspective on the right side of the screen switches off.

- ▶ If necessary, change the direction of exit ③.

- ▶ **To initiate the unparking procedure:** press the button ① again.

or

- ▶ Depress the brake pedal and select **Start Unparking Procedure** ④ (depending on the respective vehicle equipment).
- ▶ If necessary, change the transmission position. Observe any messages displayed on the driver display and central display. The vehicle moves out of the parking space. The duration of the unparking procedure is indicated by a progress bar.

The turn signal indicator is automatically switched on when the unparking procedure is initiated, and automatically switched off again when it is completed. You are responsible for selecting the turn signal indicator in accordance with the traffic conditions. If necessary, select the turn signal indicator accordingly.

After the parking space has been exited, a warning tone and the  **Active Parking Assist Finished: Take Control of Vehicle** message prompt you to take control of the vehicle. You have to

accelerate, brake, steer and change gear yourself again.

If you do not react to the prompt to take control of the vehicle, the system will brake the vehicle to a standstill.

■ Pausing Active Parking Assist

You can interrupt the parking or unparking procedure of Active Parking Assist by performing one of the following actions, for example:

- ▶ Depress the brake pedal.
- ▶ Open the front passenger door, a rear door, the trunk or the hood.
- ▶ Apply the electric parking brake or activate the HOLD function.
- ▶ **To resume the parking or unparking procedure:** gently depress the accelerator pedal.

- ① If the electric parking brake was applied before Active Parking Assist was activated, depress the accelerator pedal gently to start the parking or unparking procedure.

Check the area around your vehicle again before resuming a paused parking procedure. Ensure that persons, animals or objects are no longer in

the maneuvering range. Observe also the system limits of Active Parking Assist.

Automatic braking function of Active Parking Assist

Persons or objects detected in the vehicle's path may trigger a sudden braking action, which will in turn halt the parking or unparking procedure. The vehicle will then remain at a standstill. The parking or unparking procedure is resumed if you depress the accelerator pedal.

Check the area around your vehicle again before resuming the parking or unparking procedure. Ensure once again that no persons, animals or objects are in the vehicle's path. Observe also the system limits of Active Parking Assist.

Maneuvering assistance

Function of Drive Away Assist

Drive Away Assist can reduce the severity of an impact when pulling away. If the system detects an obstacle in the direction of travel, the vehicle's speed is briefly restricted to approximately 1 mph (2 km/h).

A risk of collision may arise in the following situations, for example:



- If the driver mixes up the accelerator and brake pedals.
- If the driver engages an incorrect gear.
- If the driver depresses the accelerator pedal with too much force.

Drive Away Assist is active under the following conditions:

- If the vehicle was stationary and the transmission position was changed to **R** or **D**.
- If the vehicle has rolled less than approximately 3.3 ft (1.0 m) since coming to a standstill.
- If the detected obstacle is less than approx. 3.3 ft (1.0 m) away.

The **Drive-away Assist** can be deactivated or activated in the **Maneuvering Assistance** menu (→ page 289).

If a critical situation is detected, the  symbol appears in red in the selected view in the **Camera & Parking** menu.

-  If Drive Away Assist is not available, the  will symbol appear in gray. If the **Camera & Parking** menu is not open in the central display, the symbol appears together with the Parking Assist PARKTRONIC pop-up.

Drive Away Assist serves solely as an aid. It is not a substitute for you having to pay attention to your surroundings. Responsibility for safe maneuvering, parking and exiting parking spaces remains with you. Ensure that no persons, animals, objects, etc. are in the maneuvering range.

 **WARNING** Risk of accident caused by limited detection performance of Drive Away Assist

Drive Away Assist cannot always clearly identify objects and traffic situations.

- ▶ Always pay careful attention to the traffic situation; do not rely on Drive Away Assist alone.
- ▶ Be prepared to brake or swerve as necessary, provided the traffic situation permits and that it is safe to take evasive action.

System limits

The system limits of Active Parking Assist apply (→ page 281).

On uphill gradients, the performance of Drive Assist is limited.

Function of cross traffic warning

The cross traffic warning can warn you of crossing traffic when exiting a parking space. The radar sensors in the bumper also monitor the area adjacent to the vehicle.

The cross traffic warning is active under the following conditions:

- **Warning for Cross Traffic, Rear:** The vehicle is driving in reverse at a speed slower than approx. 6 mph (10 km/h).
- **Warning for Cross Traffic, Front:** The vehicle is driving forwards at a speed slower than approx. 6 mph (10 km/h) and the camera image is shown on the central display (→ page 277).

The **Warning for Cross Traffic, Front** can be deactivated or activated in the **Maneuvering Assistance** menu (→ page 289).

If a critical situation is detected, the symbol  appears in red in the selected view in the **Camera & Parking** menu.

Warning for Cross Traffic, Rear

- The vehicle can be braked automatically when crossing traffic is detected.
- If the **Camera & Parking** menu is not opened and a critical situation is detected, a warning appears on the central display together with the Parking Assist PARKTRONIC pop-up.

Warning for Cross Traffic, Front

- If Active Parking Assist is active, the vehicle can be braked automatically when crossing traffic is detected.
- A warning appears if Active Parking Assist is not active, but the **Camera & Parking** menu is open.
- If the **Camera & Parking** menu is not open, the system cannot react to crossing traffic.

The cross traffic warning serves solely as an aid, and is not a substitute for you paying attention to your surroundings. The responsibility for safe

maneuvering, parking and exiting parking spaces remains with you. Ensure that no persons, animals, objects, etc. are in the vehicle's path.

⚠ WARNING Risk of accident caused by limited detection performance of the cross traffic warning

The cross traffic warning cannot always clearly identify objects and traffic situations.

- ▶ Always pay careful attention to the traffic situation; do not rely on the cross traffic warning alone.
- ▶ Be prepared to brake or swerve as necessary, provided the traffic situation permits and that it is safe to take evasive action.

System limits

i If the cross traffic warning is not available, the  symbol appears in gray.

The system limits of Active Parking Assist apply (→ page 281).

If the radar sensors are obstructed by vehicles or other objects, detection is not possible.

In the following situations, the cross traffic warning is not available:

- on uphill gradients

Function of close-range braking

Close-range braking can prevent collisions with pedestrians when the vehicle is backing up at slow speeds. If the rear-view camera detects a person in the vehicle's path, the vehicle can be braked to a standstill.

Close-range braking can intervene under the following conditions:

- The vehicle is backing up at a speed slower than 6 mph (10 km/h).
- The camera image is shown on the central display (→ page 277).

Depending on the respective country, close-range braking can be deactivated or activated in the **Maneuvering Assistance** menu (→ page 289).

When close-range braking is triggered, the symbol  appears in red in the selected view in the **Camera & Parking** menu.

- ① If close-range braking is not available, the symbol  appears in gray.

Close-range braking serves solely as an aid. It is not a substitute for you having to pay attention to your surroundings. The responsibility for safe maneuvering, parking and exiting parking spaces remains with you. Ensure that no persons, animals, objects, etc. are in the vehicle's path.

⚠ WARNING Risk of accident caused by limited detection by the maneuvering brake function

The maneuvering brake function cannot always clearly detect people. Other obstacles are not detected by the function.

In these cases, the function may brake unnecessarily or not brake at all.

- ▶ Always pay careful attention to the traffic situation; do not rely on the maneuvering brake function alone.

▶ Be ready to brake.

System limits

Observe the system limits of the following functions:

- Active Parking Assist (→ page 281)
- 360° camera (→ page 273)
- Rear-view camera (→ page 271)

The close-range braking function is not available in the following situations:

- on uphill gradients

Switching parking support on or off

Multimedia system:

  **Settings**  **Assistance**
 **Parking**

- ① This function is an on-demand feature (→ page 24).

- ▶ **Select parking support** .
- ▶ Switch the desired parking support on or off.

Memory Parking Assist

■ Function of Memory Parking Assist

Memory Parking Assist can park your vehicle using a previously stored parking space. You can store parking procedures with a total distance of up to 550 yds (500 m) (110 yds (100 m) per parking or unparking procedure).

During parking or unparking, the system can travel a previously stored distance of up to approximately 110 yds (100 m) to or out of the desired parking space, for example, from the driveway entrance into the garage.

Within a radius of approx. 165 yds (150 m), only one parking or unparking procedure can be recorded.

Use Memory Parking Assist only on private property. Use on public roads, e.g. in public parking spaces, is not permitted.

Memory Parking Assist serves solely as an aid. It is not a substitute for you having to pay attention to your surroundings. The responsibility for safe maneuvering, parking and exiting parking spaces remains with you. Ensure that no persons, animals or objects etc. are in the vehicle's path.

System limits

Observe the system limits of Active Parking Assist (→ page 281).

▲ WARNING Risk of accident due to objects located above or below the detection range of Memory Parking Assist

If there are objects above or below the detection range, the following situations may arise:

- Memory Parking Assist may steer too early.
- The vehicle may not stop in front of these objects.

This result in a collision.

▶ In these situations, do not use Memory Parking Assist.

Objects located above or below the detection range of Memory Parking Assist may not be detected during the parking procedure.

Drawbars of parked trailers that protrude into the parking space, for example, may not be detected.

Do not use Memory Parking Assist in the following situations, for example:

- In extreme weather conditions, such as ice, packed snow or in heavy rain.
- When transporting a load that protrudes beyond the vehicle.
- If the parking space is on a steep downhill or uphill gradient.
- When snow chains are installed.

■ Recording a parking procedure using Memory Parking Assist

Requirements:

- The entire route is, for example, within your own property and not on public roads.
- The system needs reference points in the surroundings to orient itself, such as fences, walls or trees. A certain distance must therefore be driven after starting the vehicle. If not enough reference points are detected in the surrounding area, no new route can be recorded.

- Sufficient distance is maintained between the vehicle and surrounding objects as the parking procedure is being recorded.

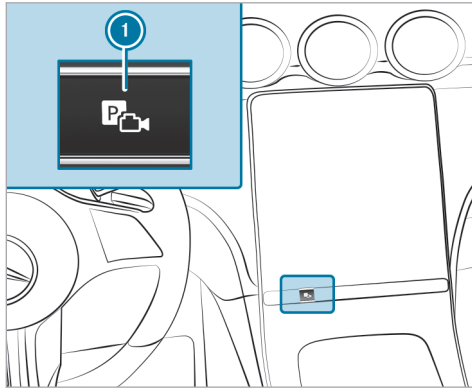

- ▶ Press the button ①. The **Camera & Parking** view opens on the central display.

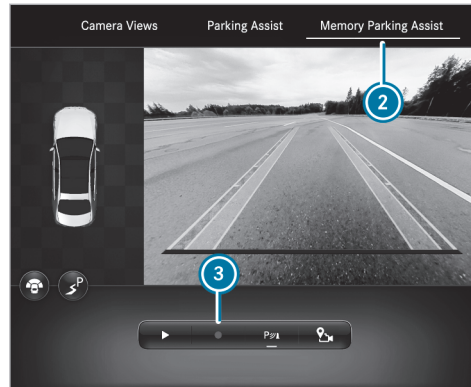

- ▶ Select the menu **Memory Parking Assist** ②.
 - ▶ Brake the vehicle to a standstill at the desired starting point of the assisted parking procedure, e.g. a driveway entrance.
 - ▶ **To start recording:** tap ③.
- ⓘ If not all conditions for a recording are met, the symbol ③ is grayed out.

- ▶ Park the vehicle in the desired parking space. Do not exceed a speed of 5 mph (8 km/h).
 - ▶ **To stop recording:** stop the vehicle and tap ③ again. The recording is stored.
- ⓘ In the Memory Parking Assist settings you can delete and rename stored parking procedures.

▶ Parking with Memory Parking Assist

Requirements:

- A parking procedure has been recorded.

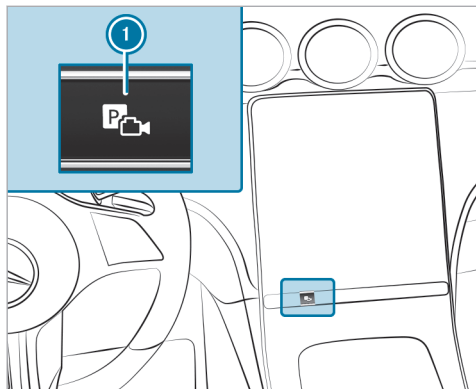

- ▶ Press the button ①. The **Camera & Parking** view opens on the central display.



- ▶ Select the **Memory Parking Assist** ② menu.
- ▶ Brake the vehicle to a standstill at the starting point of the stored parking procedure.
- ▶ **To start the parking procedure:** press .
- ▶ Select the stored parking procedure from the list.

- ▶ Follow the instructions on the central display. The vehicle drives into the selected parking space.

ⓘ The turn signal indicator is not switched on automatically. You are responsible for selecting the turn signal indicator in accordance with the traffic conditions.

- ▶ Following completion of the parking procedure, secure the vehicle against rolling away.

Exiting a parking space with Memory Parking Assist

Requirements:

- The unparking procedure was recorded together with the respective parking procedure and stored separately within one driving cycle.
- The vehicle was parked using Memory Parking Assist.

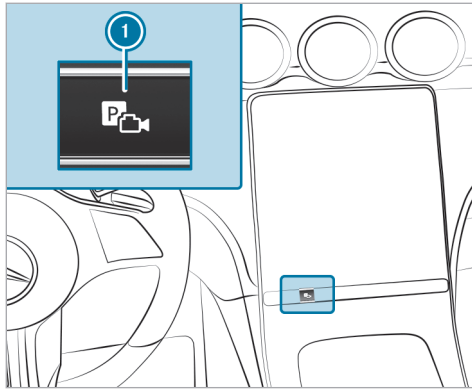

- ▶ Press the button ①.
The **Camera & Parking** view opens on the central display.



- ▶ Select the **Memory Parking Assist** ② menu.

Starting the unparking procedure

- ▶ Press .
- ▶ Confirm the saved unparking procedure.
- ▶ Follow the instructions on the central display.
The vehicle drives the recorded route.

① The turn signal indicator is not switched on automatically. You are responsible for selecting the turn signal indicator in accordance with the traffic conditions.

- ▶ Take control of the vehicle after the unparking procedure has been completed.

Setting Memory Parking Assist

Multimedia system:

- ▶  ▶ **Settings** ▶ **Assistance**
- ▶ **Parking** ▶ **Memory Parking Assist**

Renaming a recording

- ▶ Select **Manage Tracks**.
- ▶ Select  next to the desired recording.
- ▶ Enter a name and confirm with **OK**.

Deleting a recording

- ▶ Select **Manage Tracks**.
- ▶ Select  next to the desired recording.
- ▶ Select **Delete Entry**.

Deleting all recordings

- ▶ Select **Manage Tracks**.
 - ▶ Select  next to one of the desired recordings.
 - ▶ Select **Delete All**.
- ⓘ Alternatively, you can delete all data in Memory Parking Assist by resetting the multimedia system (→ page 323).

Vehicle towing instructions

The vehicle is not suitable for the use of tow bar systems that are used for flat towing or dinghy towing, for example. Attaching and using tow bar systems may result in damage to the vehicle. When you are towing a vehicle with tow bar systems, safe driving characteristics cannot be guaranteed for the towing vehicle or the towed vehicle. The vehicle-trailer combination may swerve from side to side.

! NOTE Mercedes-AMG E Performance

- ▶ Observe the notes in the Supplement. You could otherwise fail to recognize potential dangers.

The Mercedes-AMG E Performance model is not available in all countries.

Observe the following information:

- Permitted towing methods (→ page 396)
- **Plug-in hybrid:** permitted towing methods (→ page 397)
- The notes on towing the vehicle with both axles on the ground (→ page 398)

Notes on the driver display

⚠ WARNING Risk of accident if the driver display malfunctions

if the driver display is inoperative or its functions are restricted, you will not receive information about such issues as other function restrictions, speed, current drive range and the status of the electric parking brake.

This will impair operating safety.

- ▶ Stop the vehicle immediately in accordance with the traffic conditions and switch it off. Do not continue driving.
- ▶ Consult a qualified specialist workshop.
- ▶ Have the vehicle transported rather than towed.

! NOTE Mercedes-AMG vehicles

- ▶ Observe the notes in the Supplement. You could otherwise fail to recognize dangers.

If the operating safety of your vehicle is impaired, park the vehicle immediately and safely. Contact a qualified specialist workshop.

The driver display shows the following basic information:

- Indicator and warning lamps
- Speed and engine speed
- Transmission position
- Fuel level or state of charge

Additional functions available include the following:

- Various menus, such as **Assistance** and **Navigation**
- Status displays for the driving systems
- Display messages
- Information regarding **Consumption** and **Range**
- Power meter level and state of charge of the high-voltage battery

Some menu content and settings can be changed.

Driver display malfunction

⚠ WARNING Risk of accident if the driver display malfunctions

if the driver display is inoperative or its functions are restricted, you will not receive information about such issues as other function restrictions, speed, current drive range and the status of the electric parking brake.

This will impair operating safety.

- ▶ Stop the vehicle immediately in accordance with the traffic conditions and switch it off. Do not continue driving.
- ▶ Consult a qualified specialist workshop.
- ▶ Have the vehicle transported rather than towed.

Identifying a driver display malfunction

A driver display malfunction can be identified by characteristics such as the following:

- When the vehicle is switched on, the driver display continues to show nothing but a black screen.

- The driver display restarts.
- The content freezes.
- The display stops showing data such as speed. In addition, various indicator and warning lamps light up.

The driver display also does not work during an update.

What to do in the event of a driver display malfunction

If the driver display is inoperative or its functions are restricted, stop the vehicle immediately in accordance with the traffic conditions and switch it off. The following procedure is recommended in this eventuality:

- ▶ Stop the vehicle in accordance with the traffic conditions.
- ▶ While the vehicle is stationary, continue to hold the brake pedal down.
- ▶ Press the **P** button on the DIRECT SELECT lever.
- ▶ Apply the parking brake.

- ▶ Slowly release the brake pedal and make sure that the vehicle is secured against rolling away.
 - ▶ Press and hold the start/stop button (→ page 220) once for roughly three seconds to switch off the drive system.
 - ▶ Contact a qualified specialist workshop immediately.
 - ▶ Have the vehicle transported rather than towed.
- i** In addition, note the additional information about switching off the vehicle (→ page 220) and the notes on transporting the vehicle (→ page 399).

Operating the driver display

⚠ WARNING Risk of distraction from information systems and communications equipment

If you operate information systems and communication devices integrated in the vehicle

when driving, you could be distracted from the traffic situation. This could also cause you to lose control of the vehicle.

- ▶ Only operate this equipment when the traffic situation permits.
- ▶ If you cannot be sure of this, stop the vehicle whilst paying attention to road and traffic conditions and operate the equipment with the vehicle stationary.

Observe the legal requirements for the country in which you are currently driving when operating the driver display.

Scrolling on the menu bar

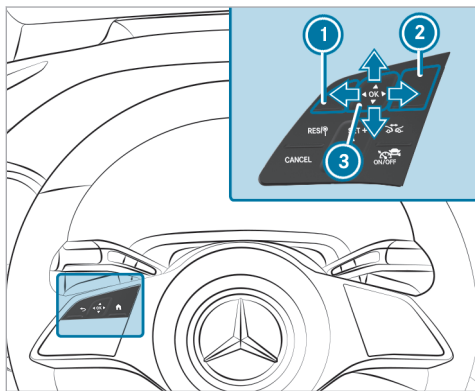

- ① Back button
- ② Main menu button
- ③ Touch Control

The controls on the left of the steering wheel manage the content of the driver display. Swipe with your finger on Touch Control ③ to navigate

vertically or horizontally through the content. Press the Touch Control to confirm your selection.

- ① Use the tip of your thumb to operate Touch Control ③ in the most effective way. Set the sensitivity of the Touch Control on the central display.
- ▶ Briefly press the main menu button ②.
- ▶ Select a menu by swiping to the left or right on Touch Control ③.
- ▶ **To confirm:** press Touch Control ③.

Driver display menus

Notes on menus on the driver display

⚠ WARNING Risk of distraction from information systems and communications equipment

If you operate information systems and communication devices integrated in the vehicle when driving, you could be distracted from the traffic situation. This could also cause you to lose control of the vehicle.

- ▶ Only operate this equipment when the traffic situation permits.
- ▶ If you cannot be sure of this, stop the vehicle whilst paying attention to road and traffic conditions and operate the equipment with the vehicle stationary.

Observe the legal requirements for the country in which you are currently driving when operating the driver display.

The following menus can be called up via the menu bar on the driver display:

- Sport
- Classic
- Understated
- Navigation
- Assistance
- Offroad (equipment-dependent)
- Service

On some of the menus, you can choose between different display content in the center display area.

On most of the menus, you can use **Options** to configure further settings for the menu-specific display content.

You can find additional information about the possible settings and selections on the menus in the Digital Operator's Manual.

Calling up the Sport menu (plug-in hybrid vehicles)

Driver display:



The **Sport** menu provides additional information about the operating energy as well as the recuperated power of the vehicle.

▶ Open the **Sport** menu via the driver display menu bar.

- ① When you call up the **Sport** menu on the menu bar of the driver's display, the menu color setting will automatically be applied to the MBUX multimedia system.

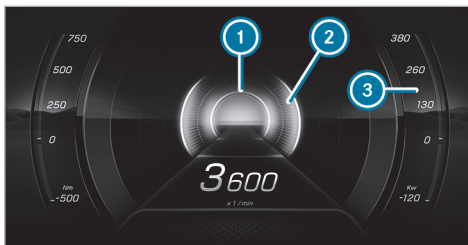

- ① Display area for recuperated power (recuperation)
- ② Display area for output
- ③ Additional display area for output

Head-up Display

Function of the head-up display

The head-up display projects various content into the driver's field of vision, for example.

Use the head-up display menu bar to select different contexts, e.g.:

- **Minimal**

- **Sport**
- **Standard**
- **Settings**
- Activating/deactivating **Head-up Display**

Head-up display content with navigation (9x3°)

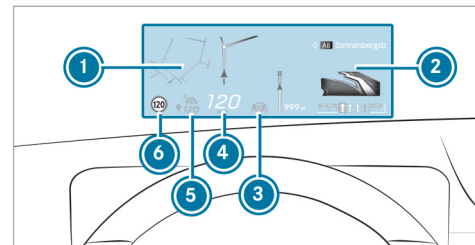

- ① Navigation instructions
- ② Navigation instructions (distance to the next route event)
- ③ Status of Active Steering Assist
- ④ Current speed

- 5 Set speed in the driving system (e.g. cruise control)
- 6 Detected traffic signs (Traffic Sign Assist)

When you receive a call, the head-up display and the driver display will show the  Call Waiting message.

- i The call will also be shown on the central display.

System limits

Visibility is influenced by the following conditions in particular:

- Seat position
- Image position setting
- Ambient light
- Wet road surfaces
- Objects on the display cover
- Polarization in sunglasses

Operating the head-up display

Selecting display content of the head-up display via the menu bar of the driver display

- ▶ Press the main menu button  on the left.
- ▶ **To select the menu bar of the head-up display:** swipe upwards on the Touch Control.





Switching between display content on the head-up display

- ▶ Swipe to the left or right on the Touch Control. A preview of the selected display content will appear on the head-up display.
- ▶ **To confirm:** press the  button.

Switching back to the driver display

- ▶ Press the  or  button.

Setting the position and brightness

- ▶ Swipe to the left or right on the Touch Control and select **Settings** on the menu bar of the head-up display.
- ▶ Press the Touch Control. The current position and brightness settings will be displayed as graphics on the head-up display as well as on the driver display.
- ▶ **To adjust the position:** swipe upwards or downwards on the Touch Control.
- ▶ **To adjust the brightness:** swipe to the left or right on the Touch Control. The settings configured for position and brightness will be saved automatically.
- ▶ Press the  or  button to exit the settings.

Switching the head-up display on/off

Driver display:



Switching on

- ▶ Swipe upwards on the Touch Control.
- ▶ Press the Touch Control.

Switching off

- ▶ Swipe upwards on the Touch Control.
- ▶ Swipe on the Touch Control and select **Head-up Display**.
- ▶ Press the Touch Control.

Vehicles with a 48 V on-board electrical system

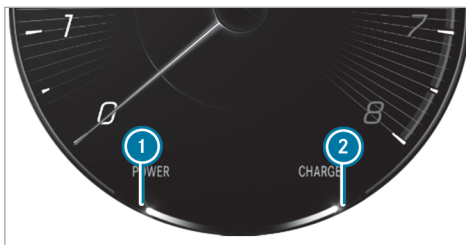

- ① Electric drive support
- ② Recuperation behavior of the electric motor
- ⓘ Due to various system limits, the values displayed may temporarily differ slightly from the actual value.

Function of the power meter (plug-in hybrid vehicles)



- ① Start of the POWER display range
- ② End of the POWER display range
- ③ Current state of charge of the high-voltage battery/remaining range
- ④ Maximum recovered energy
- ⑤ Start of the display range of the recovered energy

The power meter has the following functions:

- In electric mode, area ① – ② shows what percentage of the electrical drive is currently





being used. The combustion engine is switched on at a percentage of 100 %. In boost mode, the electrical power assistance of the drive is displayed.



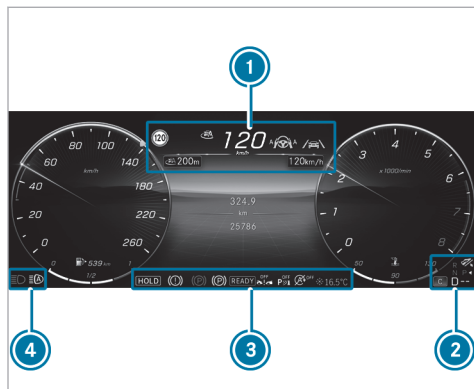











- The area ④ – ⑤ shows the recuperation and charging behaviour using the combustion engine.
- i** Due to various system limits, displayed value ④ may temporarily differ slightly from the actual value.

Overview of status indicators on the driver display

The status indicators for the driving and driving safety systems can be found in display sections ① to ④.



-  Pedestrian detection (on assistant display only)
-  Active Parking Assist is available (→ page 283)
-  Active Parking Assist has detected a parking space (→ page 283)
-  Parking Assist PARKTRONIC deactivated (→ page 280)

-  Cruise control (→ page 237)
-  Active Distance Assist DISTRONIC (→ page 239)
-  Specified distance for Active Distance Assist DISTRONIC (→ page 239)
-  Active Brake Assist switched off (→ page 260)
-  Active Brake Assist impaired or not functioning (→ page 260)
-  Active Steering Assist (→ page 246)
-  Active Lane Change Assist (→ page 250)
-  Active Lane Keeping Assist (→ page 268)
-  Active Blind Spot Assist (on assistant display only) (→ page 267)
-  Plug-in hybrid operation activated
-  Haptic accelerator pedal (→ page 190, 187, 192)
-  Sound generator inoperative (→ page 465)
-  ECO start/stop function (→ page 185)
-  HOLD function (→ page 234)
-  Adaptive Highbeam Assist (→ page 147)

302 Driver's display

Adaptive Highbeam Assist Plus
(→ page 148)



Active Stop-and-Go Assist (→ page 246)



Slippery road surface warning

Vehicles with Traffic Sign Assist: detected instructions and traffic signs (→ page 260)

Important information from other driving systems may briefly appear in front of the displayed traffic signs.

Overview and operation

Notes on the MBUX multimedia system

⚠ WARNING Risk of distraction from information systems and communications equipment

If you operate information systems and communication devices integrated in the vehicle when driving, you could be distracted from the traffic situation. This could also cause you to lose control of the vehicle.

- ▶ Only operate this equipment when the traffic situation permits.
- ▶ If you cannot be sure of this, stop the vehicle whilst paying attention to road and traffic conditions and operate the equipment with the vehicle stationary.

You must observe the legal requirements for the country in which you are currently driving when operating the multimedia system.

Depending on the equipment, the scope of function and product designation of your MBUX multimedia system may differ from the description and

images in this Operator's Manual. For example, route guidance with augmented reality is not available in all equipment variants.

⚠ NOTE Increased surface temperature due to direct sunlight on the central display/ front passenger display

The surface of the display is very dark.

If the display is exposed to direct sunlight, the surface may heat up considerably.

- ▶ If the display has been exposed to direct sunlight, allow it to cool down before touching it for a longer period of time.

i The functions of your MBUX multimedia system may differ and depend on the following factors:

- Market
- National version
- Technical conditions

Functions, services and service aspects provided by Mercedes-Benz and/or third-party providers may no longer be available when the

contractual period expires or due to technical conditions. There is therefore no entitlement to the continuous provision of functions and services.

The described functions may be modified, optimized and adapted after the time of going to press.

Mercedes-Benz therefore reserves the right to introduce changes in the following areas:



- Features
- Services
- Service aspects

For these reasons, descriptions and depictions relating to the MBUX multimedia system may, in some cases, differ for your vehicle.

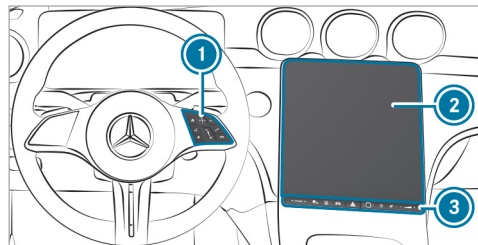
Overview of the MBUX multimedia system



- 1 Touch Control and control panel for the MBUX multimedia system
 - Operating Touch Control
- 2 Central display with touch functionality for the driver
 - Overview of the zero layer (→ page 305)
 - Calling up and operating the zero layer (→ page 307)
 - Home screen overview
 - Operating the touchscreen
- 3 Switch panel for:
 -  Fingerprint sensor

-  Switches the MBUX multimedia system on or off, switches the central display on or off
-  Switches sound on or off
-  Adjusts the volume

Further operating options:

- Conducting a dialog with the MBUX Voice Assistant.
- Operating functions contact-free with the MBUX Interior Assistant.

The interaction then follows intelligently, reactively or with hand or head movements.

- i You can find further information about operation as well as about applications and services in the Digital Operator's Manual.

Anti-theft protection

This device is equipped with technical provisions to protect it against theft. Further information on anti-theft protection can be obtained at an authorized Mercedes-Benz Center.

Zero layer

Function of the zero layer

- i Your software can be upgraded to a more current version at a later date.

The zero layer provides you with dynamic content from the MBUX multimedia system and is used to quickly access and control the applications you use. When you select  on the central display, the digital map with the applications appears in the lower display area. Compared to the home screen with a classic menu, the steps required to call up the applications are reduced. You can switch between the zero layer and the home screen with a classic menu.

The applications can be hidden from the display area and shown again.

The zero layer provides the following modules and applications:

- Navigation module

In the expanded view you can, for example, have the route overview displayed, switch on the display of traffic information and make set-

tings for the **View** (map), **Messages & Acoustic Signals** and the **Route**.

- Entertainment (media, radio) and telephone
When the lower display area is shown, the entertainment sources are always displayed. A mobile phone must be connected to the MBUX multimedia system for the phone to be displayed.
- Active applications
The lower display area shows an active message program, for example.
- Suggestions
Suggestions are displayed on the lower display area based on context and your user behavior. Here are a few examples:
 - Latest calls
 - Active message programs
 - Vehicle functions
 - Online voice applications
 - Personalized routines

The learning function of the system recognizes your typical operating sequences and

offers to perform these automatically for you as a routine.

Modules and applications are first shown in a reduced view. By tapping on them, you can operate them or open the associated menu (expanded view).

A long press on a suggestion opens a context menu in which further functions are available.

The learning function can be switched on and off for the options.

Overview of the zero layer

Digital map and user-specific applications (example)



- 1 Navigation module (reduced view)
- 2 Enters a destination
Searches for parking

- ③ Calls up the Control Center (pull the bar down)
- ④ Status line
- ⑤ Calls up user profile settings
- ⑥ Content sharing menu (if available)
- ⑦ Telephone
Requirement for phone: the mobile phone is connected to the MBUX multimedia system.
- ⑧ Entertainment sources (media, radio)
- ⑨  Press briefly: shows all applications (→ page 307)
Press and hold: calls up the home screen with classic menu
- ⑩ Route monitor
e.g. route list, lane recommendations, toll stations, 3D image of the upcoming driving maneuver

The zero layer shows the digital map and the user-specific applications.

The following user-specific applications are displayed in the lower display area:

- Suggestions
Requirement: suggestions are activated (→ page 317).
- Active applications
e.g. a massage program
e.g. Active Parking Assist
- Telephone ⑦
- Entertainment sources ⑧
- Online voice applications

The lower display area can be hidden and shown (→ page 307).

Information about entertainment sources

You can operate the applications in the reduced view or in the menu (expanded view) (→ page 307).

Examples:

- Control a media source, e.g. pause/play, next track, set a station

- Select tracks from the current playlist or stations from the station list
- Select a media source
The media source must be connected to the MBUX multimedia system.

Information about the telephone

To use the functions, the mobile phones must be connected to the MBUX multimedia system.

Requirement for suggestions: the [Calls & Messages](#) option is activated in the suggestions.

Examples:

- Answer a call and call a missed call
The missed calls are displayed for the mobile phones connected to the MBUX multimedia system.
- Display contacts and call list and call a contact
- Use voice functions
- Suggest contacts
The contacts are suggested for the mobile phones connected to the MBUX multimedia system. No contacts are suggested for the

mobile phones that are linked to another user profile.

- Write messages to contacts (suggestion)
- Connect a device via the device manager (suggestion)

Information about active applications

The following functions are available:

- Operating a massage program
- Operating an ENERGIZING COMFORT program

Suggestions for comfort and vehicle functions as well as navigation

Requirement: the **Comfort, Vehicle** and **Navigation** options are activated in the suggestions.

- Operating a massage program
For example, the multimedia system suggests a program at a certain time.
- Opening the trunk lid
Requirement: the vehicle is equipped with trunk lid convenience closing.
- Operating an ENERGIZING COMFORT program
- Making heating settings

- Activating/deactivating Parking Assist PARKTRONIC
- Selecting previous destinations and destinations from favorites

Suggestions for online voice applications

Requirement: the **Online Voice Services** option is activated in the suggestions.

The suggested voice applications are made available online and are based on your previous voice inputs.

Examples:

- What will the weather be like tomorrow?
- Play the messages.
- Start geoquiz.
- Open the garage door.

Suggestions for activating recognized routines

Requirement: the **Learning & Suggestions** option is activated in the suggestions.

Routines are actions that run automatically under certain conditions. An example of a routine: whenever you drive to work in the morning (condition), the MBUX multimedia system should set a

certain message program (action). Routines can also perform different actions.

Calling up and operating the zero layer

Calling up the zero layer



When the vehicle has been switched on, the zero layer is displayed with the digital map. Navigation is active.

▶ **From another application:** press the  button on the right side of the steering wheel.

or

▶ Tap on .

Operating applications in the reduced view (examples)

▶ **Media:** to play the previous or next track, tap  or .



▶ **To answer a call or call a missed call:** tap on the contact.

After the connection has been established, the call functions are available.

▶ **To end a call:** tap on the contact again.

- ▶ **To reply to a message:** tap on a message and dictate the message via the MBUX Voice Assistant.
- ▶ **To start a message program:** tap on the application and start the message program.
- ▶ **To select a previous destination:** tap on the application and select one of the previous destinations.
- ▶ **To select a destination from the favorites:** tap on the application and select the destination.

Hiding and showing the display area with applications

- ▶ **To hide:** pull the applications down.
 - ▶ **To show:** pull the bar above  upwards.
- or
- ▶ Select .
- or
- ▶ Press the  button on the steering wheel on the right.

Navigation module (expanded view)



Example: route guidance is active

- ① Destination
 - ② Searches for a gas station
 - ③ Switches traffic information display on or off
- ▶ Tap on the navigation module (→ page 305).
 - ▶ Select **Route** in the lower menu bar.

Operating a menu in the lower display area (example: active message program)

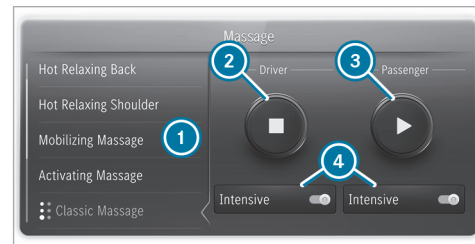

- ① Selects a message program
- ② Starts/stops a program for the driver
- ③ Starts/stops a program for the front passenger
- ④ Sets the message intensity for the driver's or front passenger seat

- ▶ Tap on the application. The expanded view of the application is displayed.
- ▶ **To close the menu:** select .



Opening and closing the context menu for a suggestion

- ▶ Press and hold on a suggestion. The context menu opens and shows the **No Longer Suggest** option, for example.
- ▶ **To close:** swipe downwards.



Removing a suggestion from the display area

- ▶ Swipe the suggestion upwards.

Showing all applications



- ▶ Briefly press . Available applications are displayed.
- ▶ **To hide applications:** briefly press  again.

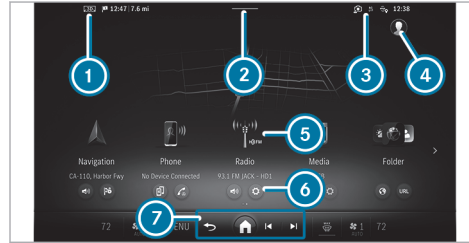

Switching between the zero layer and home screen with classic menu

- ▶ Press and hold on . The home screen with classic menu is shown.
- ▶ **To return to the zero layer:** press and hold on .

Home screen overview



- ① Status line
- ② Calls up the Control Center: pull the bar down
- ③ Displays in the status line
- ④ Calls up user profile settings and switches user
- ⑤ Calls up applications
- ⑥ Quick-access to application
- ⑦ Global menu
 -  Calls up previous menu
 -  Press and hold: switches between home screen and zero layer

-  Previous track or previous radio station
-  Next track or next radio station

- ① During a telephone call, the call duration is displayed in global menu ⑦.

Alternatively, to switch between the home screen and the zero layer, press and hold the  button on the right-hand side of the steering wheel.

When bar ② is pulled down, the Control Center appears.

The following functions are called up in the Control Center:

- Notifications Center
- Quick vehicle access

Operating the MBUX multimedia system

Using Touch Control

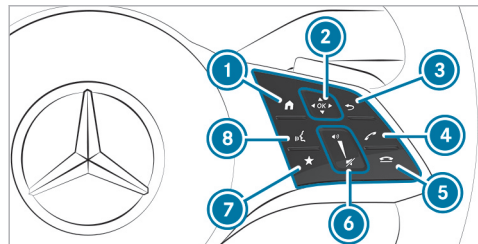

- ① Shows the home screen
- ② Touch Control
 - swipe in the direction of the arrow (navigate)
 - Press (confirm)
- ③ Returns to the previous display
- ④ Makes or accepts a call
- ⑤ Rejects or ends a call
- ⑥ To increase volume: swipe upwards
To reduce volume: swipe down

- To switch off the sound: press
- ⑦ Calls up telephone favorites
- ⑧ Starts the MBUX Voice Assistant

You can navigate through menus and lists via the touch-sensitive surface of Touch Control ② using a **single-finger swipe**, e.g.:

- ▶ **To enter a character:** select a character using the keyboard and press on Touch Control ②.
- ▶ **To select a menu option:** scroll in a list and press Touch Control ②.
- ▶ **To move the digital map:** swipe in any direction.

Using the touchscreen

The following buttons are available on the switch panel below the central display:

- Switches the MBUX multimedia system on or off
 - Switches sound on or off
 - Adjusts the volume
- Press or or swipe over the button

- ▶ **To select a menu item or entry:** tap on a symbol or an entry.
- ▶ **To increase the map scale:** tap twice quickly with one finger.
- ▶ **To reduce the map scale:** tap with two fingers.
- ▶ **To enter characters with the keypad:** tap on a button.
- ▶ **To navigate in menus:** swipe up, down, left or right.
- ▶ **To use handwriting to enter characters:** write the character with one finger on the touchscreen.
- ▶ **To zoom in and out of the map:** move two fingers together or apart.
- ▶ **To enlarge or reduce the size of a section of a website:** move two fingers together or apart.
- ▶ **To turn the digital map:** turn counter-clockwise or clockwise using two fingers.
- ▶ **To move the digital map:** touch the touchscreen and move your finger in any direction.

- ▶ **To save the destination in the digital map:** touch the touchscreen and hold until a message is shown.
- ▶ **To set the volume on a scale:** touch the touchscreen and move the finger to the left or right.
- ▶ **To call up a global menu in the applications:** touch the touchscreen and hold until the **Options** menu appears.

Function of the MBUX Voice Assistant

⚠ WARNING Risk of distraction from information systems and communications equipment

If you operate information systems and communication devices integrated in the vehicle when driving, you could be distracted from the traffic situation. This could also cause you to lose control of the vehicle.

- ▶ Only operate this equipment when the traffic situation permits.

- ▶ If you cannot be sure of this, stop the vehicle whilst paying attention to road and traffic conditions and operate the equipment with the vehicle stationary.

For your own safety, always observe the following points when operating mobile communications equipment and especially your voice control system:

- Observe the legal requirements for the country in which you are driving.
- If you use the voice control system in an emergency your voice can change and your telephone call, e.g. an emergency call, can thereby be delayed.
- Familiarize yourself with the voice control system functions before starting the journey.

Using the MBUX Voice Assistant, vehicle functions and various areas of the MBUX multimedia system can be operated by voice input. The MBUX Voice Assistant is operational approximately half a minute after switching on the vehicle and can be operated from all seats. Further information and

examples of voice commands can be found in the Digital Operator's Manual.

You can use the MBUX Voice Assistant to operate the following functions depending on the vehicle equipment:

- Telephone
- Text message and e-mail
- Navigation
- Radio and media
- Vehicle functions
- Online functions

Full functionality of the voice control system is only available for you with activation of online voice control.

Conducting a dialog

Starting a dialog

- ▶ Say **Hey Mercedes** to activate the MBUX voice assistant. Voice activation must be switched on in the multimedia system.

or

- ▶ Press the  button on the multifunction steering wheel. A blue wave appears in the MBUX multimedia system. The dialog can be started. For the dialog with the MBUX Voice Assistant, you can use complete sentences of colloquial language as voice commands. Voice activation can also be directly combined with a voice command, e.g. "Hey Mercedes, how fast can I drive?"

Calling up help

- ▶ **For information about the MBUX voice assistant:** say Hey Mercedes, what can you do?

Operating functions (examples)

- ▶ **To operate the navigation system:** Is there a service area along the route?
- ▶ **To operate the phone:** Call my father.
- ▶ **To change the system language to English (short command):** "Change language to English".
- ▶ **To operate the radio:** "Show me the list of radio stations."

- ▶ **To operate media:** "Switch on random playback."
- ▶ **To operate vehicle functions:** "Switch the seat heating to level 2."
- ▶ **To operate online functions:** "What's the time in Sydney?"
- ▶ **To ask a question about the vehicle:** "Do I have Blind Spot Assist?"

Overview of the MBUX Interior Assistant

⚠ WARNING Risk of injury from the camera's laser radiation

This product uses a classification 1 laser system. If the housing is opened or damaged, laser radiation may damage your retina.

- ▶ Do not open the housing.
- ▶ Always have maintenance work and repairs carried out by a qualified specialist workshop.

This product complies with the requirements of the FDA 21 CFR 1040.10 and 1040.11 with

exception of the variations according to the FDA Laser Notice No. 50 from 24 June 2007.

- ① The camera records image data for the applications, for example body, head and hand detection. The camera converts the image data directly into meta data. No image data is saved in the process. The data is only processed in the vehicle and is not transmitted from the vehicle.
- ① When you start the vehicle, the MBUX Interior Assistant is activated automatically. You can switch the Interior Assistant on or off.

The MBUX Interior Assistant detects the presence of the front vehicle occupants using 3D laser cameras. The Assistant interprets natural hand, head and body movements contextually or upon the explicit request of the vehicle occupants. The Assistant can thus automatically trigger vehicle interior functions and assist appropriately to the situation.

The Assistant recognizes driver and front passenger interactions.

The applications are available under the following conditions:

- The MBUX Interior Assistant is activated.
- The MBUX multimedia system is activated.

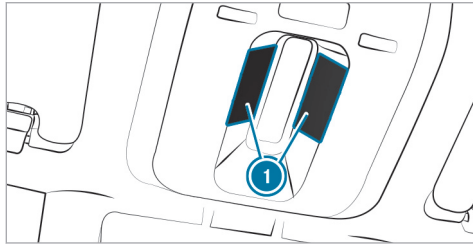

Cameras ① are located in the overhead control panel.

The Assistant supports vehicle and infotainment functions at three interaction levels:

- INTELLIGENT
The Assistant recognizes vehicle occupants automatically and activates functions.
- REACTIVE

The Assistant recognizes the natural body language of a vehicle occupant and carries out functions automatically, appropriate to the situation.

- CONTACTLESS

The vehicle occupant actively requests a function using a hand movement.

The Assistant offers functions for the following:

- SAFETY

The Assistant supports vehicle occupants with the use of restraint systems.

- COMFORT

The Assistant enhances comfort by automating functions inside the vehicle and supporting natural interaction with the vehicle.

- INFOTAINMENT

The Assistant facilitates operation of the Infotainment functions.

System limits, display messages and notes for rectification

The malfunction messages are shown on the central display.

The system may be impaired or may not function in the following situations:

- The camera in the overhead control panel may heat up due to operating conditions. As a result the camera may switch off temporarily, particularly during longer periods of operation and at high outside temperatures.

Do not touch or cover the camera. Wait until the camera has cooled down and is available again.

The **Interior Assistant Unavailable Further Information to Follow** message appears.

You receive a message when the camera is available again.

- The camera is covered, dirty, fogged up or scratched.

Wait until the camera has cooled down before cleaning the camera cover.

The **Currently Unavailable See Operator's Manual** message appears.

Clean the outside of the camera cover with a dry or damp cotton cloth. Do not use micro-

fiber cloths. Do **not** remove the cover when cleaning.

- A vehicle occupant is very large. Clothing being worn (gloves, hat, scarf, color of clothing) or objects carried on a person, for example a watch with a large display, can affect the camera view. Or the detection range of the camera is restricted.

No message appears.

Keep the camera's field of vision clear.

Objects in the detection range of the camera can restrict the camera view. Please make sure that no objects hang on the inside rearview mirror, for example.

- The MBUX Interior Assistant is faulty.
The **Interior Assistant Not Available. Please contact your Mercedes-Benz dealer.** message appears.
Consult an authorized Mercedes-Benz Center.

Switching the reading light and search light on or off

Requirements:

- **For the reading light:**
 - The driver's and front passenger's hand movement takes place under the inside rearview mirror.
- **For the search light:**
 - The function is available in the vehicle when it is dark.
 - The front passenger seat is not occupied or a child is sitting in a child restraint system.
 - The hand movement is made by the driver in the interaction area above the front passenger seat.

Switching the reading light on and off



Carrying out operation of the reading light for the driver and front passenger

- ▶ Move your hand up and down under the inside rearview mirror.
The reading light is switched on or off.

Switching the search light on and off

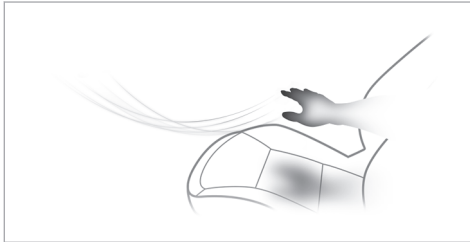

Interaction area for activating the search light

- ▶ **To switch on:** reach across the front passenger seat with a hand. The search light is switched on automatically for the driver.
- ▶ **To switch off:** take a hand back away from the front passenger seat. The search light is switched off again.

Automatic preselection of the outside mirrors (COMFORT/reactive)

Until now, to set the outside mirrors the desired mirror had to be selected using a preselection button in the driver's door.

With the MBUX Interior Assistant, the mirror to be set is preselected automatically by the natural movement of your head to the left or right. When the hand touches the button for adjusting the outside mirror, the LED under the button of the preselected mirror side lights up.

Use the button to set the position of the active outside mirror.

- ① Preselection of the outside mirrors using buttons is still possible. Further information on adjusting the outside mirrors (→ page 155).
- ① This function is not supported if the MBUX Interior Assistant is not available.

Information on users, suggestions and favorites

⚠ WARNING Risk of becoming trapped during adjustment of the driver's seat after calling up a driver profile

Selecting a user profile may trigger an adjustment of the driver's seat to the position saved under the user profile. You or other vehicle occupants could be injured in the process.

- ▶ Make sure that when the position of driver's seat is being adjusted using the multimedia system, no people or body parts are in the seat's range of movement.

If there is a risk of someone becoming trapped, immediately stop the adjustment process by:

- ▶ a) Pressing the warning message on the central display.
- or
- ▶ b) Pressing a position button of the memory function or a seat adjustment switch in the driver's door. The adjustment process is stopped.

The driver's seat is equipped with an access preventer.

If the driver's door is open, the driver's seat will **not** be set after calling up the driver's profile.

User profiles and user-specific content

Prerequisites for the vehicle owner:

- You have a Mercedes me user account.
 - You have a Mercedes me PIN.
 - You have agreed to the terms of use.
 - The vehicle is linked to a Mercedes me user account.
- i** If one of the pre-requisites listed is missing or if no user profile has been selected, the data described in the following section will be saved in the vehicle as the standard setting. Standard settings can be changed by all vehicle users.

Personal settings for the respective user are stored in a user profile. If the vehicle is used by several people, a person can change their profile settings without changing the settings of other users.

- i** Some settings apply to the entire vehicle and are displayed in all user profiles, e.g. ambient lighting and the current navigation settings. These initially belong to the driver, but can also be changed by the other vehicle occupants in their user profile.

You can individualize a user profile in the vehicle using the set-up assistant or using the settings in your user profile. Some settings, e.g. the Mercedes me PIN and a profile photo are made in the Mercedes me App or in the Mercedes me Portal.

- i** If the user profile is downloaded while traveling, user profiles are not set up using the set-up assistant.

User-specific content and applications with personal data are protected by different levels of security. To access protected content, the Mercedes me PIN and, depending on the vehicle equipment, biometric sensors can be used.

To access protected content, the Mercedes me PIN and, depending on the vehicle equipment, biometric sensors are used.

- i** The security level is set by the multimedia system and calculated from the combination of all sensor inputs. Some security levels cannot be turned off.

- i** When a user profile is activated, the following personalized comfort systems, for example, can be adjusted or their settings loaded:

- Seat
- Ambient light
- Outside mirrors
- Roller blinds
- Climate control settings

If the user profile is activated when driving, the driver's seat position will not be adjusted.

Depending on the vehicle equipment you can, as a user, save the following settings, for example:

- Driver's seat, steering wheel and mirror settings
- Climate control
- Ambient lighting
- Radio (including station list)

- Suggestions

This function is an on-demand feature (→ page 24): if the vehicle key is linked to the user profile, the user profile is pre-activated when unlocking the vehicle or approaching a vehicle with KEYLESS-GO. Light, mirror and seat adjustments are made during this process. To use a user profile or an application, the vehicle key also serves as a sensor input for authorization.

Suggestions

The vehicle can learn the habits of the driver. It then makes suggestions regarding navigation destinations, phone numbers and music preferences. The requirements for that are the selection of a user, your consent to the recording of data and sufficient collected data.

Configuring a user profile

Requirements:

- The vehicle is stationary.

Multimedia system:



Adding a user

- ▶ Select **Add User** .
A QR code is loaded.
- ▶ Scan the displayed QR code with the Mercedes me App or any QR code scanner on a mobile device. If the Mercedes me App is not yet installed on your mobile device, you will be directed to the store of your mobile device.
- ▶ Follow the directions in the app.
The vehicle is connected with your Mercedes me user account. This automatically creates your user profile in the vehicle.

If only your user profile is available, it will be loaded automatically.

If more than one user profile is available, you will be directed to the user selection.

When the vehicle is stationary, the set-up assistant starts automatically after user selection.

Protecting user-specific content and applications

If you add a new user, access protection is already activated for the user profile. The Mercedes me PIN and, depending on the vehicle equipment, biometric sensors are available for access. Biometric sensors in the vehicle must be taught in. The authentication process then takes all taught-in and available sensors into account.

The following user-specific content and applications are protected, for example:

- User selection and user profile settings
- Biometric sensors
The teaching-in of biometric sensors
For teaching in and editing biometric data see the following section.
- Suggestions
The data and determination of the most probable navigation destinations, media sources, radio stations, contacts and messages.
- ENERGIZING COACH
The recorded health data and its evaluation.
- Parking service

The payment transactions.

- Mercedes me Store
The purchase of services.
- System activations of paid vehicle functions

In the following cases you will be prompted for authentication or re-authentication using a sensor or the Mercedes me PIN:

- When selecting a protected user profile
- When calling up a function requiring special protection
- If biometric sensors provide insufficient or contradictory information
- If the multimedia system no longer trusts a sensor
- If the seat belt buckle and the door are opened at the same seat and a function requiring special protection is called up

- ▶ Switch **Protect Content** on or off.
- ▶ Switch **Access Protection** on or off.

- ❗ When access protection is switched off, your user profile can be viewed from any seat and changes can be made.
- ❗ Access protection is switched on or off on a vehicle-specific basis.
- ❗ Note that authentication is necessary for some functions and therefore cannot be switched off completely.

Setting up, editing and deleting biometric recognition

The biometric data models are saved in the sensors in the vehicle. If recognition has been taught-in, this sensor serves as a contributory factor for authentication on the multimedia system.

- ▶ Select **Protect Content**.
- ▶ Select **Fingerprint Recognition**.
- ❗ If necessary, authenticate yourself on the multimedia system.

Setting up fingerprint recognition

- ▶ Place and lift your finger several times on the fingerprint sensor under the touchscreen (→ page 304).
The finger is scanned. If the scanning procedure is successful, a message appears on the central display. You can unlock your user profile and protected applications with your fingerprint.

Deleting biometric data

- ▶ Tap on  behind **Fingerprint Recognition**.
- ▶ Select **Yes**.

Calling up the set-up assistant

- ▶ Select **Profile**.
- ▶ Select **Set-up Assistant**.
- ▶ Follow the directions from the set-up assistant.

Deleting a user profile

- ▶ Select **Profile**.
- ▶ Select **Remove**.

- ▶ Select **Remove User Profile**.

ⓘ Your Mercedes me user account and your personal data will remain within the Mercedes me ecosystem.

Resetting the user profile to factory settings

- ▶ Select **Profile**.
- ▶ Select **Reset**.
- ▶ Select **Yes**.

ⓘ This resets the contents of the user profile to factory settings, but not the vehicle.

Selecting a user

ⓘ When you call up your driver profile, the driver's seat and the steering wheel can be set.

You can cancel the setting process with the following actions:

- Press **Tap Here to Cancel** message on the central display.
- Press one of the seat operating buttons in the driver's door.

- ▶ Select **Select User**.

- ▶ Select a user.

▶ When requested to do so, authenticate with the Mercedes me PIN or a taught-in biometric characteristic.
The user profile is loaded and activated.

ⓘ If you select **Continue Without Selecting a User**, no specific settings for the user profile are loaded.

Configuring and deleting suggestions

- ▶ Select .
- ▶ Select **Settings**.
- ▶ Select **System**.
- ▶ Select **Suggestions**.
- ▶ Activate or deactivate **Learning & Suggestions**.

If the user profile is active and the function is switched on, personalized suggestions can be derived for activated applications.

- ▶ Select .
- ▶ Switch the options on or off individually.
If an option is switched on and sufficient data has been gathered, personalized suggestions

based on your user behavior will be offered to you on the zero layer. These are, for example, navigation destinations visited, phone numbers dialed as well as suggestions based on your music preferences.

- ▶ **To delete collected suggestions:** select .
- ▶ Select **Yes**.
The suggestions are reset.

System settings

Overview of the system settings menu

In the system settings menu, you can make settings in the following menus and control elements:

- Display
 - Display brightness
 - Switching the head-up display on/off
- Control elements
 - Keyboard language and handwriting recognition
 - Sensitivity of Touch Control

- Haptic operation for the touchscreen
- MBUX Voice Assistant
- MBUX Interior Assistant
- Sound
 - Entertainment
 - Navigation and traffic announcements
 - Telephone
- Data protection
- Connectivity
 - Wi-Fi, Bluetooth®
- Time & date
- Language
- Units for distance
- System PIN
- Suggestions
- Software update
- System reset

Overview of software updates

Important software updates may be necessary for the security of your multimedia system's data. Install these updates, or else the security of your multimedia system cannot be ensured.

The multimedia system displays a corresponding message when a software update is available.

If the **Automatic Online Update** option is active, software updates are downloaded automatically. If the option is deactivated, you will be informed of new software updates once. The software updates are available for downloading for a limited period of time.

Carrying out a software update:

- You can start software updates via the communication module.
- You can start software updates via a WLAN hotspot.
- You can start map updates from an external medium.

❗ Online software updates cannot be performed via external Wi-Fi hotspots that are encrypted via TKIP.

❗ To complete software updates via the communication module, the vehicle must be connected with the Internet and a Mercedes me user account.

❗ To complete software updates via WLAN, the vehicle must be connected to an external WLAN hotspot.

A software update consists of three steps:

- Downloading or copying of the data required for installation
- Installation of the downloaded software update
- Activation of the downloaded software update

❗ It may be necessary to restart the MBUX multimedia system after completion of a software update.

❗ While some software updates are being downloaded, the multimedia system cannot be operated and the vehicle functions may be restricted.

- i** Some software updates require a safe vehicle status for the installation to be completed. They can only be carried out in a safely parked vehicle with the vehicle switched off.

For software updates requiring a safe vehicle status: when the last installation step is reached, a message appears on the central display after the vehicle is switched off. Follow the step-by-step instructions on the central display to complete the installation.

There are software updates that can only be installed when the vehicle is safely parked, there are no more people in the vehicle and the vehicle is locked.

Availability of the driver and central display

During the installation of software updates, it is not possible to use the vehicle, central display and driver display. You may receive the following display message when an installation is running:

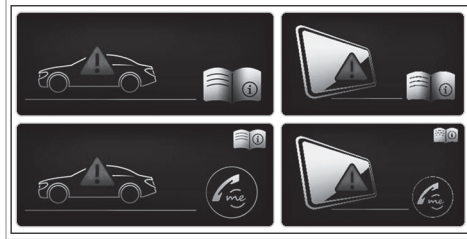

- i** The display message does not appear every time a software update is installed.
- In rare cases, an error can occur during the installation. The multimedia system automatically attempts to restore the previous version.

If it is not possible to restore the previous version, the display message shown above appears every time the vehicle is started.

Failure of the driver display

If the driver display fails or there is a malfunction, you may not recognize limitations in the functions of systems relevant to safety or the speed display, for example. This may impair the operating safety of the vehicle. Park the vehicle safely as soon as

possible and notify a qualified specialist workshop (→ page 474).

Further information about software updates can be found at <https://me.secure.mercedes-benz.com>

Failure of the central display

If the central display fails or the display message shown above is shown continuously, several systems such as the rear view camera, Parking Assist PARKTRONIC or climate control are no longer available. Drive on carefully and consult a specialist workshop as soon as possible.

Setting up a Wi-Fi hotspot

Requirements:

- The Wi-Fi function is activated on the multimedia system and the communication device to be connected.
- The communication device to be connected supports at least one of the types of connection described.

The connection types shown depend on the device to be connected. The function must be

supported by the multimedia system and by the device to be connected. Select the type of connection on the multimedia system and on the device to be connected.

- ❶ Some functions may first need to be activated on the communication device being connected. More detailed information can be found in the manufacturer's operating instructions.
- ❷ The use of the vehicle data tariff by external devices is not available in all countries.

Multimedia system:

➔  ➔ Settings ➔ System
➔ Internet and Bluetooth

- ❶ The availability of the functions is country-dependent.
- Select **Wi-Fi**.
The controller is to the right: Wi-Fi is switched on.

When the Wi-Fi function is switched on, you can connect the multimedia system with external hotspots or make it available as a hotspot for external devices.

When the Wi-Fi function is switched off, it is not possible to establish a hotspot connection.

- ❶ Depending on the vehicle equipment, you can obtain an Entertainment Package via the Mercedes me Store. In order to use the data package included, you must conclude your own contract with a mobile phone network provider via the Mercedes me App. This can be terminated at any time and incurs no costs. Without this contract it is not possible to use the services included in the previously acquired Entertainment Package. The availability of this option is dependent on the country. If the data package option is not available or can be upgraded, you can purchase data volume directly from the mobile phone network provider for a fee. The availability of this option is dependent on the country.
- ❷ The use of the vehicle data tariff by external devices is not available in all countries.

Using the multimedia system as a Wi-Fi hotspot

- Select **MBUX Hotspot**.
- Select one of the following connection options.

Connecting using a QR code

Requirement: an app for scanning the QR code is installed on the device being connected.

Alternatively: the device being connected has an integrated QR code scanner (see the manufacturer's operating instructions).

- Scan the QR code shown.
The WLAN connection is established.

Connecting using a security key

- Select the vehicle from the device to be connected. The vehicle is displayed with the **MBUX XXXXX** network name.
- Enter the security key which is shown in the central display on the device to be connected.
- Confirm the entry.

Generating a new security key

- Select the **Generate New Security Key** option in the **MBUX Hotspot** menu.
- Confirm the prompt with **Yes**.
A new security key is generated.

A connection will be established with the newly created security key.

- ❗ When a new security key is generated, all existing Wi-Fi connections are then disconnected. If the Wi-Fi connections are re-established, enter the new security key.

Using a mobile communication device as a Wi-Fi hotspot (tethering)

Requirement: the Wi-Fi function on the mobile phone and Internet access via Wi-Fi are activated (see the manufacturer's operating instructions).

- ❗ This function is country-dependent.

- ▶ Select the **Manage Internet Access** option in the **Internet and Bluetooth** menu.
- ▶ Select **Search for Access**.
- ▶ Select the network.
- ▶ Log in to the Wi-Fi network.

or

- ▶ Select the mobile phone with the  Wi-Fi symbol.

- ❗ With external Wi-Fi hotspots, which are encrypted via TKIP, online software updates

cannot be carried out via the external Wi-Fi hotspot.

System language

Notes on the system language

This function allows you to determine the language for the menus and navigation announcements. The selected language affects the characters available for entry. The navigation announcements are not available in all languages. If a language is not available, the navigation announcements will be in English.

Setting the language

Multimedia system:

- ➔  ▶ Settings ▶ System
- ▶▶ Language

Setting the system language

A list of the available system languages is shown.

- ▶ Select a language.
The system language is switched to the selected language.

Resetting the multimedia system (reset function)

⚠ WARNING Risk of accident due to failure of central display functions

While the multimedia system is reset, its functions, such as the rear view camera, are not available.

- ▶ Only reset the multimedia system when the vehicle is stationary.

Requirements:

- The vehicle is switched on.
- Some settings can only be reset when the vehicle is stationary.

Multimedia system:

- ➔  ▶▶ Settings ▶▶ System ▶▶ Reset

When resetting the system, personal data and settings are deleted, for example:

- Connected devices
- Individual user profiles
- Biometric data

-  The data used and saved in the multimedia system by the driver assistance systems is deleted.

 - ▶ Select **Reset**.
A query appears asking if the system should really be reset.
 - ▶ Select **Yes**.
The multimedia system is reset to the factory settings. The multimedia system is restarted after the system reset.
-  Due to data protection, as well as the function of individual driving systems and driving safety systems, it is a requirement to carry out a complete system reset before selling the vehicle or transferring it to a third party, or after use as a hire car.

AMG TRACK PACE

Function of AMG TRACK PACE

-  This function is an on-demand feature and can be activated via Mercedes me after you purchase your vehicle. The Digital Operator's

Manual contains further information on Mercedes me and on-demand features.

AMG TRACK PACE can be used to analyze and optimize driving characteristics on race tracks. You can drive previously saved race tracks (e.g. the Hockenheimring), or record and save new tracks. The lap times set will be stored for every track. These can be analyzed and compared with other lap times to achieve the best possible race results. Additionally, acceleration and braking operations can be measured and stored.



Note: Use AMG TRACK PACE only on closed circuits away from public roads. Adapt your driving style to your personal skill level and the ambient conditions. As the driver, you are solely responsible for driving your vehicle. Park your vehicle safely before operating the application.

Setting Track Race



Multimedia system:

 TRACK PACE  Track Race

Recording a new track

- ▶ Select  **New Track**.
- ▶ Select  **Start Recording** at the desired starting point.
Track recording will start at this point.

During track recording, sectors can be set to divide up the track.

- ▶ Select  **Set sector**.
- ▶ To finish track recording, select  **Stop recording** or cross the starting line again.
- ▶ Confirm the prompt with **Yes**.
- ▶ Select the weather.

-  The temperature will be determined automatically.



 - ▶ Enter a name.

- ▶ Press **OK** to confirm.
The track will be saved under the name entered.

Searching by track name

- ▶ Select  **Search** .
- ▶ Enter the track name.
Tracks with the name that you have searched for will be displayed.



Measuring time on a saved track

- ▶  Select **All tracks**.
- ▶ Select the desired track.
- ▶ Select .
- ▶ If you are already at the starting line, select **Start Time Recording**.

or

- ▶ Select **Navigate to** to navigate to the starting line.

Timekeeping will begin automatically when you cross the starting line.

- ▶  Selecting  enables you to switch to the AR view of the track. Selecting  also allows you to switch to the telemetry display.

- ▶ Select  **Stop timing** to end timekeeping.
- ▶ Confirm the prompt with **OK**.
- ▶ Select the weather.
- ▶ Select **Yes** to save the times set for this track.

Showing readings during Track Race

The following readings can be shown:

- Tire temperature
- Miniature map
- Sector overview
- Engine data
- G-force display
- Lap overview

- ▶ Select  **Start Time Recording** .

- ▶ Select  .

- ▶ Drag the desired reading from the grid to the left or right edge of the central display.
The readings will be shown during Track Race.

Selecting  on the active reading will deactivate it.

Displaying analysis

- ▶  Select **All tracks**.
An overview of all the tracks you have driven will appear.

- ▶ Select a track.
- ▶ Select a session.

The following data will be displayed:

- lap and sector times
- average speed and maximum speed
- driver
- vehicle
- date
- weather

- ▶ Select **Add Recording** to use another session for comparison.
- ▶ Select  to return to the overview.
- ▶ Select **Diagram**.
- ▶ Set the desired parameters. The analysis will be displayed.

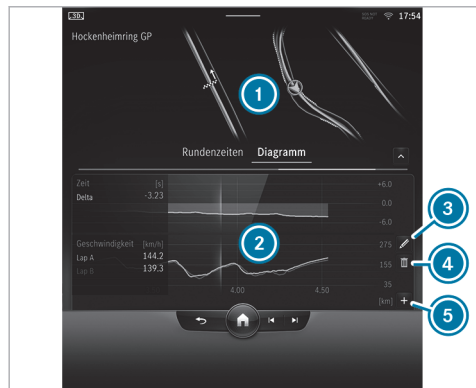

- ① Lap overview
- ② Parameter overview



- ③ Editing parameters
- ④ Deleting parameters
- ⑤ Adding a new parameter

❗ The following values can be set for parameters, for example:

- speed
- longitudinal/lateral acceleration
- steering angle
- engine speed
- engine oil/tire temperature



Based on the analysis, you can check and optimize driving characteristics for any position on the track.

Exporting tracks (USB)

- ▶ Select  **Tracks** .
- An overview of all saved tracks will appear.
- ▶ Select the desired track.
- ▶ Select options  for the desired track.

- ▶ Select **Export Track to...**
- The selected track can be exported to a USB storage device connected to the vehicle.

Editing tracks and recordings

- ▶ Select  **Tracks** .
- ▶ Select the desired track.
- ▶ Select options  for the desired track.
- ▶ Select **Rename** or **Delete**.

or

- ▶ Select a track.
- ▶ Highlight the desired recording.
- ▶ Select  options.
- ▶ Select **Export to...** or **Delete**.

Setting Drag Race

Multimedia system:

 **TRACK PACE**  **Drag Race**

Measuring acceleration

- ▶ Select  **Drag race options**.

- ▶ Select **Acceleration**.
- ▶ Set a starting speed or select **Automatic**. Measurement will begin as soon as the specified starting speed has been reached.
- ▶ Set a target speed. Measurement will stop as soon as the specified target speed has been reached.
- ▶ Start off and begin measurement. Measurement will begin when the vehicle accelerates.

You can stop measurement early by interrupting the acceleration procedure.

Quarter-mile race

- ▶ Select  **Drag race options**.
- ▶ Select **Quarter Mile**.
- ▶ Set a target distance. Measurement will stop as soon as the specified target distance has been reached.
- ▶ Start off and begin measurement. Measurement will begin when the vehicle accelerates. Timing will run until the target

distance or a maximum of one mile has been traveled.

You can stop measurement early by interrupting the acceleration procedure.

Measuring braking

- ▶  **Drag Race options**
- ▶ Select **Braking**.
- ▶ Set a starting speed or select **Automatic**.
- ▶ Start off and begin measurement.
- ▶ Brake to a standstill. Measurement is incremental, in steps of 6 mph (10 km/h) to a standstill. If the braking procedure is started e.g. at a speed of 98 mph (157 km/h), measurement will start as soon as a speed of 93 mph (150 km/h) has been reached.

Saving and calling up measurements

If measurement is completed or canceled, a prompt will appear asking whether the measurement should be saved.

- ▶ Confirm the prompt with **OK** to save.

Calling up saved measurements

- ▶  Select **History**.
 - ▶ Select **Acceleration**, **Quarter Mile** or **Braking**.
 - ▶ Select a measurement. The desired measurement will be displayed in detail.
- or
- ▶ Delete a measurement.

Calling up the telemetry display

Multimedia system:

 **TRACK PACE**  **Telemetry**

The telemetry display shows current vehicle data as a digital value and as a diagram. Up to four parameters can be selected to be shown on the display.

For example:

- engine speed
- wheel angle
- speed
- steering angle

- ▶ Set the desired parameters.
- ▶ Set the time.
The set parameters will be evaluated in the diagram for the selected time.

Configuring AMG TRACK PACE

Requirements:

To connect a mobile device to the TRACK PACE app:

- The TRACK PACE app is installed on the mobile device.
- The mobile device is connected to the multimedia system via Wi-Fi.

Multimedia system:



Connecting a mobile device via the TRACK PACE app

The TRACK PACE app makes it possible to record videos and to synchronize them with stored tracks.

- ▶ Select **TRACK PACE App**.

- ▶ Select **Authorize a New Device**.
- ▶ Start the TRACK PACE app on the device to be connected.
- ▶ Select **Continue** and confirm the authorization prompt.
A four-digit code will be shown on the central display.
- ▶ Enter the code on your smartphone.
The device will be authorized.

De-authorizing a mobile device

- ▶ Select **TRACK PACE App**.
- ▶ Select a device.
- ▶ Confirm the prompt with Yes.
The device will be de-authorized.

Setting the TRACK PACE readout on the head-up display and driver display

- ▶ Select **IC and HUD Contents**.
- ▶ Activate or deactivate the desired content.
The content on the head-up display and driver display will be adjusted.

- ⓘ Further information on the indicator on the head-up display (→ page 298).
- ⓘ Further information on the driver display (→ page 295).

Setting acoustic feedback

- ▶ Select **Acoustic Feedback**.
A scale from 0 to 10 will be shown.
- ▶ Select a setting.

Showing statistics

- ▶ Select **TRACK PACE Statistics**.
Statistics on the current user profile will be displayed.

The following data will be displayed:

- driving time
- distance driven
- tracks recorded
- track races recorded
- laps recorded
- drag races recorded
- maximum speed

Activating ambient light

If this function is active, the vehicle interior will be lit in red or green depending on delta time.

- ▶ Select **Ambient Light**.
- ▶ Activate or deactivate the function.

Setting a dash cam

If the vehicle is equipped with a dash cam, it can be used in AMG TRACK PACE.

- ▶ Select **Dashcam**.
- ▶ Select **Track Race** or **Drag Race** and switch on **Activate Recording**.
- ▶ You can set which overlay is to be used in the recorded video under **Video Overlay Content**.

Plug-in hybrid settings

Configuring the charging settings

Multimedia system:

→  ▶▶ Hybrid ▶▶ Charging

Setting the charging program

- ▶ Select **Home**, **Work** or **Standard**.

Open the socket flap in the MMS

- ▶ Press **Open socket flap** to open the socket flap.
- ▶ The charging process can be interrupted using **Cancel Charging**. The charging process is ended and the charging cable is unlocked.
- ⓘ Further notes on charging process with alternating current: (→ page 213) or direct current: (→ page 216).

Activating or deactivating location-based charging

- ▶ Select **Charge at home** or **Charge at work**.
- ▶ Activate or deactivate **Select Based on Location**.

When the function is activated, the vehicle's current position is saved as one of the selected options. When arriving at this address again, a brief query appears asking whether the respective charging program should be selected.

Activating or deactivating quick charging (DC charging)

- ▶ Activate or deactivate the **quick charging** function.

The **quick charging** function increases the maximum possible charging power at charging stations up to 60 kW in order to charge the vehicle's high-voltage battery faster. After the charging process is complete, the charging power in the "Standard" charging program is again limited to 20 kW to protect the high-voltage battery.

Setting the departure time

The set departure times are used for the vehicle's pre-entry climate control and for predictions regarding the approximate state of charge and range at the time selected. The charging process is optimally timed for the next departure time (up to 30% of the state of charge is charged immediately and may be followed by a charging break), when quick charging is deactivated. When quick charging is activated, the charging process starts immediately, irrespective of the next departure time.

▶ Select **Next Departure Time**.

The following charging times can be selected:

- individual charging times
- a **Week Profile**

Setting an individual departure time

▶ Select **Add New Time** and set the time.

or

▶ Select  and adapt an existing departure time.

Setting repeat days

▶ Select **Add New Time** and set the time.

▶ Mark the relevant weekdays for which the departure time should apply and confirm with

.

or

▶ Select  and edit existing repeat days.



Setting a break in the charging process (when charging with AC)

Up to four breaks in the charging process can be set during which the vehicle is not charged, even if it is connected to a charging station.

▶ Select **Charging Pauses**.

▶ Select **Add New Time** and then set and save the times for the beginning and end of the break.

▶ Activate or deactivate the charging breaks that have been set.

Set charging breaks can be edited with the  button or deleted with the  button.

Setting the maximum state of charge

▶ Select **Maximum State of Charge**.

▶ Set the desired percentage.
The high-voltage battery is charged up to the set percentage as a maximum.

 The percentage can be set in increments of 10 %.

 As soon as the maximum state of charge is reached, a notification is shown on the central display that the charging process is complete and the journey may be continued. The maximum state of charge can be saved in the Home and Work charging program. In the Standard charging program, the setting is

automatically reset to a state of charge of 100 % after the vehicle is switched on or off.

Overview of the energy flow display in the multimedia system

The active components of the hybrid system are highlighted on the energy flow display. The energy flow between the individual components is shown in color.

The components displayed are:

- State of charge of the high-voltage battery
- Combustion engine
- Energy flow
- High-voltage battery

The energy flow will be shown in different colors depending on the operating status:

- **White:** constant energy flow
- **Red:** high energy flow (boost effect)
- **Green:** low-emission energy flow in the case of recuperation, electric mode and charging the high-voltage battery

Calling up the energy flow display

Multimedia system:



Info

▶ Select **Energy Flow**.

The energy flow in the vehicle will be displayed.

Information on the status of the hybrid system and the current state of charge of the high-voltage battery will be displayed in addition to the energy flow.

Off-road menu

Off-road menu overview in the multimedia system

The **Off-road** menu provides an overview of the most important, relevant data for off-road driving. The content is displayed in different tiles that can be changed with directional arrows or swipes. In addition, this menu contains buttons for quick-access to certain vehicle functions relevant to off-road operation.

Displayed data are, for example:

- Artificial horizon
- Compass
- Altitude
- Steering angle of the front and rear wheels
- Torque and power
- Tire pressure and temperature
- Transparent hood

Setting the off-road menu in the multimedia system

Multimedia system:



Setting displays in the central display

▶ Press , or on the display itself to jump to the next display.

Quick-access: activating or deactivating Parking Assist PARKTRONIC

▶ Press to switch the function on or off.

Further information on Parking Assist PARKTRONIC (→ page 277).

Quick-access: activating or deactivating ESP® (Electronic Stability Program)

▶ Press to switch the function on or off.

Further information on ESP (→ page 232).

Quick-access: activating or deactivating manual shifting

▶ Press to switch the function on or off.

Additional information on manual gearshifting (→ page 199).

Quick-access: activating or deactivating DSR (Downhill Speed Regulation)

▶ Press to switch the function on or off.

Further information on DSR .

Quick-access: setting the vehicle level

▶ Press to raise or lower the vehicle.

Additional information about vehicle level .

The availability of individual functions depends on country and equipment.

Navigation and traffic

Notes on navigation

Route guidance with augmented reality

⚠ WARNING Risk of accident and injury as a result of distraction, incorrect depiction or wrong interpretation of the display

The camera image of the augmented reality display is not suitable as a guide for driving.

- ▶ Always keep an eye on the actual traffic situation.
- ▶ Avoid extended observation of the camera image.

⚠ WARNING Risk of accident and injury due to imprecise positioning of additional information

The additional information from the augmented reality display may be inaccurate and is not a substitute for observing and assessing the actual driving situation.

- ▶ Always keep an eye on the actual traffic situation when carrying out all driving maneuvers.

Switching navigation on

Multimedia system:



- ▶ Alternatively, press the  button on the steering wheel on the right (→ page 310). The zero layer with the digital map is displayed.

Navigation overview

Digital map



① Navigation module (reduced view)

Route guidance active:

The navigation module shows the information relevant to the route in the zoomed-out view, e.g. the arrival time at the destination or a traffic delay

 Ends the current route guidance



Tapping opens the navigation module in the expanded view with the **Route**

② Enters a destination

③ Searches for a parking space

- ④ Sets map orientation  and map type
- ⑤ Current vehicle position (vehicle symbol or arrow)
- ⑥ Display area with entertainment sources, phone, active applications and suggestions
- ⑦ Navigation window shows the next driving maneuver in the reduced view when route guidance is active or an enlarged view with a detailed display of the upcoming driving maneuver when approaching a driving maneuver, e.g. a map section, 3D images or lane recommendations

When route guidance is active, tapping on the navigation window opens the route monitor, which shows information for the entire route, e.g. upcoming driving maneuvers, destinations, freeway exits or rest areas with points of interest

-  Switches off navigation announcements
-  Switches on navigation announcements

Pressing ④ several times changes the map orientation in this order:

- 2D and to the north

- 2D and in the direction of travel
 - 3D and in the direction of travel
 - Map with complete route
- ① If the map is moved, the map switches between 3D direction of travel and 2D north orientation.

Navigation module (expanded view)

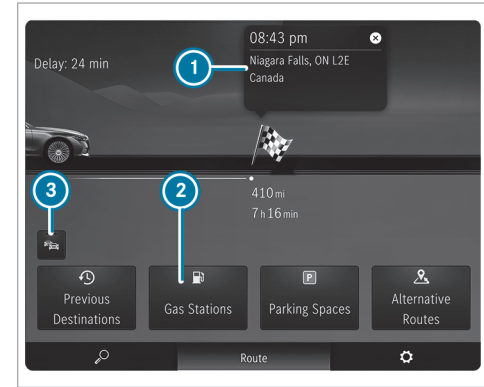

Example: route guidance is active

- ① Destination
- ② Searches for a gas station
- ③ Switches traffic information display on or off

Overview of the toll system

i The toll system is optional equipment and is not available in all vehicles.

Debiting of toll charges at freeway toll gates is facilitated with an electronic payment system.

The toll system uses RFID (Radio Frequency Identification) for data transfer between the control unit and the toll station.

The toll system is initially switched off at the factory.

The control unit is in the vehicle glove box.

In order to be able to use the toll system, it must have been registered by the customer and activated by the service provider:

- Activate the toll system in the settings of the MBUX multimedia system or on the control unit.
- There are two ways to register and activate:
 - In the Mercedes me App, register the unit identification number of the control unit and activate the toll system.

- Alternatively, you can register and activate via the **Toll Service** app.

Activation of the toll system can take up to 48 hours after registration.

When the toll system is activated, the automatic detection of the number of vehicle occupants is initially switched off at the factory. The number of vehicle occupants is preset with one person.

The following applies for roads on which toll charges are dependent on the number of vehicle occupants:

- If the automatic detection of the number of vehicle occupants is switched off, the number of vehicle occupants must be selected manually. This ensures correct toll accounting.
- The number of vehicle occupants can be transmitted automatically. In the process, the number of seat belts worn is determined.

If the number of detected persons does not correspond with the number of persons actually in the vehicle, the number of persons must be manually selected.

The standard setting of one person does not need to be changed for roads which require toll payment regardless of the number of vehicle occupants.

The toll system enables the payment of toll charges in many states of the USA.

i In Mexico, for example, the toll system can be registered and activated for journeys to the USA.

Notices

- You can only use the toll system once registration and activation are complete.
- Drive at the prescribed vehicle speed in the toll lane.
- Mercedes-Benz recommends operation using the MBUX multimedia system. Alternatively, this can also be done on the control unit in the glove box.
- For safety reasons, entries should be made while the vehicle stationary.
- For further information, please consult the Mercedes me App or an authorized Mercedes-Benz Center.

Or call 1-800-FOR-MERCEdes (in the USA) or 1-800-387-0100 (in Canada).

For information on how to register and activate the toll system, see the Digital Operator's Manual.

Destination entry

Requirements

- **For the online search:**

- There is an Internet connection.
- Mercedes me connect is available.
- You have set up a user account in the Mercedes me Portal.
- The vehicle is connected with the user account and you have accepted the terms of use.
- Further information can be found at: <https://www.mercedes.me>
- The service is available.
- The service has been activated at an authorized Mercedes-Benz Center.

i If Online Search is not available, the search is performed using the data of the digital map.

Multimedia system:

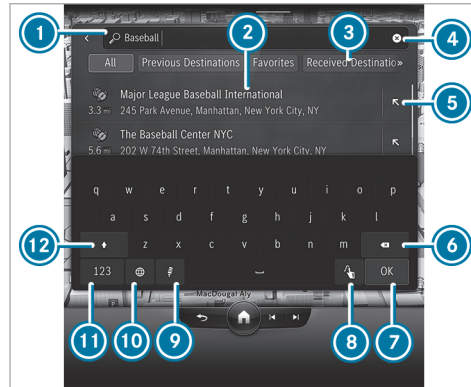

Example: entering a POI or address

- 1** Input line with current entry
- 2** Search result

- 3** Selects destination search, displays further destination searches with double arrow
- 4** Deletes an entry
- 5** Adopts the search result in the input line and continues the search
- 6** Deletes the last character entered
- 7** Hides the keypad
- 8** Switches to handwriting recognition
- 9** Starts the MBUX voice assistant
- 10** Sets the written language
- 11** Switches to digits and special characters
- 12** Switches to upper-case or lower-case letters

- ▶ Enter the destination in **1**. The entries can be made in any order. The search results are displayed in a list.
- i** Online search results for POIs may contain additional information, for example opening times and ratings. The information is provided by an online map service. This online function is not available in all countries.

- ① You can enter a destination as a three-word address from what3words. This option is not available in all countries.
- ▶ Hide the keyboard with .
- ▶ Select the destination in the list. The following menu enables the route to be calculated.
- ① Observe the notes on the MBUX multimedia system (→ page 303).

Calculating a route and using settings for route guidance



Detailed display with a route (example)

- ① Calls up alternative routes
- ② Adds the chosen destination to the existing destinations as the next intermediate destination and recalculates the route

- ③ Calculates a new route to the chosen destination
- ④ Selects a point of interest in the vicinity of the destination
- ⑤ Address of the intermediate destination

After selection of ② or ③, the route is recalculated.

- ① If there is no route yet, the route guidance starts after selecting .

▶ Select one of the options.



Calling up alternative routes

- ▶ Select **Routes**.
- ▶ Select an alternative route.

Starting route guidance

- ▶ Select .



Calling up the detailed display with destination address

- ▶ Pull the bar above the  **Let's Go!** symbol upwards. Depending on the destination selection and availability, online content, for example ratings, prices and weather information, is shown.
- ▶ **To share a destination:** select  **Share**. This option allows you to scan the displayed QR code.
- ▶ **To save a destination as a favorite:** select  **Favorite** and then an option.
- ▶ **To call up an Internet address:** if a web address is available, select **www**.
- ▶ **To call the destination:** if a telephone number is available, select **Call**.

Searching for POIs in the vicinity of the destination shown

- ▶ Select **In The Vicinity**.
- ▶ Search using categories, enter a search entry or search for a personal POI.

Selecting a route type

- ▶ In the navigation module (expanded view), select  (→ page 332).
- ▶ Select **Route**. The route is calculated as a fast route with a short journey time. Trailer mode is available if a trailer has been coupled with the vehicle. If available, you can select online routes. Traffic announcements for the route are taken into account via **Reroute Based on Traffic** .
- ⓘ Trailer mode and online routes are not available in all countries and for all vehicles.

Calculating alternative routes

- ▶ In the navigation module (expanded view), select .
- ▶ Select **View**.
- ▶ Activate **Route Overview after Start**. Alternative routes are calculated for every route.

Selecting alternative routes

- ⓘ If **Route Overview after Start** has been switched on and a route has been calculated, the function is available.
- ▶ In the navigation module (expanded view), select **Alternative Routes**.
- ▶ When the alternative routes have been calculated, display the route in the navigation window by swiping to the right or left.
- ▶ Select **Start**.

Activating a commuter route

- ⓘ A user profile has been created and **Allow Destination Suggestions** has been activated in the user options (→ page 317). Route guidance is not active.
- ▶ In the navigation module (expanded view), select .
- ▶ Select **Route**.
- ▶ Activate **Commuter Route**. The navigation system automatically detects that the vehicle is on a commuter route.

For the daily commuter route, traffic incidents on the route are also reported when driving without active route guidance.

- ▶ **To select or delete a commuter route:** select **Start** or .

Avoiding or using route sections, e.g. highways or ferries

- ▶ In the navigation module (expanded view), select .
- ▶ Select **Route**.
- ▶ Select **Avoid Options**.
- ▶ Activate or deactivate the avoid option.

Activating route guidance with augmented reality

- ▶ In the navigation module (expanded view), select .
- ▶ Select **View**.
- ▶ Select **Augmented Reality Video**.

- ▶ Activate or deactivate **Augmented Reality Video**.

The camera's video image is shown on the central display before a turning maneuver. The video image includes additional information.

Showing property information for route guidance with augmented reality

Route guidance with augmented reality is activated.

- ▶ In the navigation module (expanded view), select .
- ▶ Select **View**.
- ▶ Select **Augmented Reality Video**.
- ▶ Activate **Street Names** and **House Numbers**. During route guidance, the activated options are shown as additional information in the camera image.

Using map functions

Multimedia system:



Increasing map scale

- ▶ When the map is shown, tap twice quickly with one finger on the central display.
- or
- ▶ Move two fingers apart on the central display.

Decreasing map scale

- ▶ Tap with two fingers on the central display.
- or
- ▶ Move two fingers together on the central display.

Moving the map

- ▶ When the map is displayed, swipe in any direction with one finger on the central display.
- ▶ **To reset the map to the current vehicle position:** select  **Center**.

Selecting map orientation

- ▶ Tap repeatedly on the  compass symbol on the map.

The map orientations changes in this order:

- The 2D map view is displayed so that north is always at the top.
- The 2D map view is aligned to the direction of travel.
- The 3D map view is aligned to the direction of travel.
- The map shows the complete route.

Using services

Requirements:

- There is an Internet connection.
- Mercedes me connect is available.
- You have set up a user account in the Mercedes me Portal.
- The vehicle is connected to a user account and you have accepted the conditions of use for the service.

Further information can be found at: <https://www.mercedes.me>

- The service is available.
- The service has been activated at an authorized Mercedes-Benz Center.

Multimedia system:



Showing traffic information

Route guidance uses traffic reports via Live Traffic Information.

- ▶ In the navigation module (expanded view), select  (→ page 332).
- ▶ Select **View**.
- ▶ Activate **Traffic**.
- ▶ Activate **Traffic Incidents** and **Free Flowing Traffic**.
If there are traffic incidents on the route, these are shown on the map and in the route overview. Traffic incidents are, for example, roadworks, local area reports (e.g. fog) and warning messages.

The traffic delay is displayed for the current route. The smallest value for the display for traffic delays is a minute.

- ① For more information on Live Traffic Information, please refer to the Digital Operator's Manual.

Displaying hazard warnings

If hazard warnings are available these can be shown as symbols on the map. The display depends on the settings for the **Traffic Incidents** option.

- ▶ In the navigation module (expanded view), select  (→ page 332).
- ▶ Activate or deactivate **Traffic Incidents**.
If the option is activated, all of the symbols are shown.
If the option is deactivated, the symbols are only shown when there is a hazard warning.
The following hazards may be shown on the map:
 - Accidents and breakdowns

- Slippery roads, fog, crosswinds and heavy rain
- Hazards reported manually
- Vehicle with active hazard warning light
- Roadworks
- Additional hazards (if available)

Displaying online map contents

- ▶ In the navigation module (expanded view), select .
 - ▶ Select [View](#).
 - ▶ Switch on an online service, e.g. [Weather](#). Current weather information is displayed on the navigation map, e.g. temperature or cloud cover.
- The service information is not shown in all map scales, e.g. weather symbols.

Parking service

! **NOTE** Vehicle damage due to failure to observe the maximum permissible clearance height

If the vehicle height exceeds the maximum permissible clearance height, the roof and other vehicle parts may be damaged.

- ▶ Please observe the maximum clearance height indicated.
- ▶ If the vehicle exceeds the permissible clearance height, do not drive in.
- ▶ Take the modified vehicle height into account in the case of roof superstructures or other carrier systems.

! **NOTE** Vehicle damage due to failure to observe local information and parking conditions

The data is based on the information provided by the respective service providers.

Mercedes-Benz does not guarantee the accuracy of the information provided in relation to the car park or parking area.

- ▶ Always observe the local information and conditions.

i This service is not available in all countries.

- ▶ In the navigation module (expanded view), select  and switch on [Parking](#).

- ▶ Tap on **P** the map.

or

- ▶ In the route overview, select **P** [Parking Spaces](#) (→ page 332).

- ▶ Select a parking option.

The following information is displayed (if available):

- Destination address, distance from current vehicle position and arrival time
- Information on the car park, e.g.
 - Opening times
 - Parking charges
 - Current occupancy

- Maximum parking time
- **Maximum access height**

The maximum access height shown by the parking service does not replace the need for observation of the actual circumstances.

- Available payment options (Mercedes pay, coins, bank notes, cards)
- Details on parking tariffs
- Number of available parking spaces
- Payment method (e.g. at parking meters)
- Services/facilities at the parking option
- Telephone number

▶ Calculate the route (→ page 336).

Notes on the dashcam

! **NOTE** Risk of legal consequences due to violation of legal regulations and data protection provisions

You are legally responsible for operation and use of the dashcam functions.

The legal requirements relating to operation and use of the dashcam can vary depending on the country in which the dashcam is operated.

This function is not permitted in all countries.

- ▶ Before using the dashcam, read up on the content of the legal regulations, in particular the data protection requirements in the respective country of use.
- ▶ Observe the legal regulations, in particular the data protection requirements.

- ① Observe the following instructions for safe operation:
 - Only use FAT32 or exFAT formatted USB storage devices.

- Use USB-IF certified USB storage devices. USB-IF is a non-profit corporation and stands for USB Implementers Forum. Based on the USB specification, USB-IF certifies, for example, USB versions, corresponding cables and plugs as well as energy supply processes via the USB interface.
- USB storage devices may be damaged if often or permanently overwritten at high speed. Mercedes-Benz recommends a high-quality external SSD drive. The abbreviation SSD stands for Solid State Drive.
- ① The file size and therefore the duration of single recording is limited by the limitations of the USB flash drive format. So FAT32 formatted USB flash drives do not allow files larger than 4 GB, for example. When the file size is reached, the recording stops and you receive a notification.
- ① The following functions are available in the Gallery app:
 - Switching write protection on or off

- Deleting video files

Selecting a USB device for a video recording with the dashcam

Requirements:

- At least one USB device is connected with the multimedia system .

Multimedia system:

→  » Apps » Dashcam

- ▶ Select the USB symbol.
- ▶ Select the USB device.

- ⓘ When USB devices contain multiple partitions, recorded video files are not always displayed in the recording list.
Mercedes-Benz recommends that you use USB devices with one partition.

Starting or stopping a loop recording with the dashcam

Requirements:

- For recording and saving a video file: a USB device is connected with the multimedia system.
- The vehicle is switched on.

Multimedia system:

→  » Apps » Dashcam

- ▶ If several USB devices are connected with the multimedia system, select a USB device (→ page 342).
If no USB device is selected, a selection is made automatically when recording starts.
- ▶ **To select recording mode:** select **Loop Recording**.
Loop Recording continuously records short video files. When the memory is full, recording is continued automatically. In doing so, the oldest video file is written over.

- ▶ **To start:** select **Start Recording**.
The length of the recording is shown. The **Do not remove the storage medium during recording. Before removing the storage medium, eject it first.** message appears. The video file is stored on the USB device.

- ▶ **To end:** select **End Recording**.

- ⓘ In some countries, geo-coordinates (longitude and latitude) are shown in the video image. For technical reasons, the geo-coordinates may show greater inaccuracies.

A message may appear in the following cases:

- The camera is not functional, the **Camera Unavailable** message appears.
Have the camera checked in an authorized Mercedes-Benz Center.
- If the country border indication has been switched on.
- If an outdoor recording is started with the camera app during a dashcam recording, the dashcam recording pauses and resumes automatically after the camera recording is finished. A notification to this effect is displayed.

Starting or stopping individual recordings with the dashcam

Requirements:

- For recording and saving a video file: a USB device is connected with the multimedia system.
- The vehicle is switched on.

Multimedia system:

→  » Apps » Dashcam

- If several USB devices are connected with the multimedia system, select a USB device (→ page 342).
If no USB device is selected, a selection is made automatically when recording starts.
- To select recording mode:** select **Individual Recording**.
Individual Recording stops recording when the memory limit is reached. An individual recording is automatically protected against being overwritten.

▶ **To start:** select **Start Recording**.
The length of the recording is shown. The **Do not remove the storage medium during recording. Before removing the storage medium, eject it first.** message appears. The video file is stored on the USB device.

▶ **To end:** select **End Recording**.

-  In some countries, geo-coordinates (longitude and latitude) are shown in the video image. For technical reasons, the geo-coordinates may show greater inaccuracies.

A message may appear in the following cases:

- Individual Recording:** the memory is full or there are only a few minutes recording time available. The video recording stops or will be stopped imminently.
Change the USB device or delete a video file.
- The camera is not functional, the **Camera Unavailable** message appears.
Have the camera checked in an authorized Mercedes-Benz Center.
- If the country border indication has been switched on.

- If an outdoor recording is started with the camera app during a dashcam recording, the dashcam recording pauses and resumes automatically after the camera recording is finished. A notification to this effect is displayed.

Telephone

Telephony

Notes on telephony

 **WARNING** Risk of distraction from operating integrated communication equipment while the vehicle is in motion

If you operate communication equipment integrated in the vehicle when driving, you could be distracted from the traffic situation. This could also cause you to lose control of the vehicle.

- ▶ Only operate this equipment when the traffic situation permits.
- ▶ If you cannot be sure of this, stop the vehicle whilst paying attention to road

and traffic conditions and operate the equipment with the vehicle stationary.

⚠ WARNING Risk of accident from operating mobile communication equipment while the vehicle is in motion

Mobile communication devices distract the driver from the traffic situation. This can also cause the driver to lose control of the vehicle.

- ▶ As a driver, only operate mobile communication devices when the vehicle is stationary.
- ▶ As a vehicle occupant, use mobile communication devices only in the designated area, e.g. in the rear passenger compartment.

You must observe the legal requirements for the country in which you are currently driving when operating the multimedia system and mobile communication equipment in the vehicle.

⚠ WARNING Risk of injury due to objects being stowed incorrectly

If objects in the vehicle interior are stowed incorrectly, they can slide or be thrown around and hit vehicle occupants. In addition, cup holders, open stowage spaces and mobile phone receptacles cannot always retain all objects within.

There is a risk of injury, particularly in the event of sudden braking or a sudden change in direction.

- ▶ Always stow objects so that they cannot be thrown around in such situations.
- ▶ Always make sure that objects do not protrude from stowage spaces, parcel nets or stowage nets.
- ▶ Close the lockable stowage spaces before starting a journey.
- ▶ Always stow and secure heavy, hard, pointed, sharp-edged, fragile or bulky objects in the trunk/cargo compartment.

Observe the additional information on stowing mobile communications devices correctly:

- Loading the vehicle (→ page 119)

Bluetooth® connection:

The menu view and the available functions in the telephone menu are in part dependent on the Bluetooth® profile of the connected mobile phone. If the mobile phone supports all the following Bluetooth® profiles, the full range of features is available:

- PBAP (Phone Book Access Profile)
 - The contacts on the mobile phone are shown automatically on the multimedia system.
- MAP (Message Access Profile)
 - The mobile phone message functions can be used on the multimedia system.
- HFP (Hands-Free Profile)
 - Wireless telephony is available on the multimedia system.
- SAP (SIM Access Profile)

- The Car Phone has access to the SIM card data and dials into the mobile phone network via the exterior aerial.

Irrespective of this, Bluetooth® audio functionality can be used with any mobile radio unit.

For information on the range of functions of the mobile radio unit to be connected, see the manufacturer's operating instructions.

Network connection:

The following cases can lead to the call being disconnected while the vehicle is in motion:

- You switch into a transmission/reception station, in which no communication channel is free
- The SIM card used is not compatible with the network available
- A mobile phone with "Twincard" is logged into the network with the second SIM card at the same time

The multimedia system supports calls in HD Voice® for improved speech quality. A requirement for this is that the mobile phone and the

mobile phone network provider of the person you are calling support HD Voice®.

Depending on the quality of the connection, the voice quality may fluctuate.

Further information can be obtained from an authorized Mercedes-Benz Center or at the <https://www.mercedes-benz-mobile.com>

Telephone menu overview

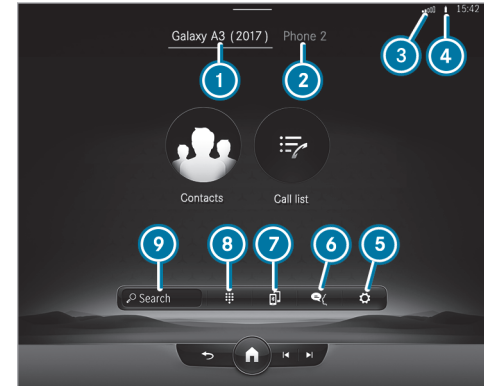

- 1 Bluetooth® device name of the currently connected mobile phone/of the mobile phone
- 2 Bluetooth® device name of the currently connected mobile phone/of the mobile phone (when several mobile phones are connected)
- 3 Signal strength of the mobile phone network
- 4 Battery status of the connected mobile phone

- 5 Options
- 6 Messages
- 7 Calls up devices
- 8 Numerical pad
- 9 Starts contact search

Overview of mobile phone usage

Depending on the equipment up to four mobile phones can be connected at once:

- A mobile phone is connected to the multimedia system via Bluetooth®.
- Additional mobile phones are connected with the multimedia system via Bluetooth®.
 - You can use all the functions of the multimedia system with all mobile phones.

Connecting a mobile phone

Requirements

- Bluetooth® is activated on the mobile phone (see the manufacturer's Operator's Manual).
- Bluetooth® is activated on the multimedia system.

Multimedia system:



Searching for a mobile phone

- ▶ Select **Connect New Device**.

Connecting a mobile phone

- ▶ Select a mobile phone.
A code is displayed in the multimedia system and on the mobile phone.
- ▶ If both codes match, confirm the code on the mobile phone.
- ① For older mobile phone models, enter a one to sixteen-digit number code on the mobile phone and on the multimedia system for authorization.
- ① Up to 15 mobile phones can be authorized on the multimedia system.
- ① Up to four of the mobile phones activated in the driver's user profile are automatically reconnected.

Functions in the telephony menu

In the telephony menu you have the following functions, for example:

- Making calls, e.g.:
 - Accept a call
 - **End Call**
 - Answer a call with a message
 - **Conference**
 - Accept or reject a waiting call
- Managing contacts, e.g.:
 - Managing the format of a contact's name
- Receiving and sending messages, e.g.:
 - Using the read-aloud function
 - Dictating a new message

Mercedes me Apps

Mercedes me calls

■ Making a call via the overhead control panel

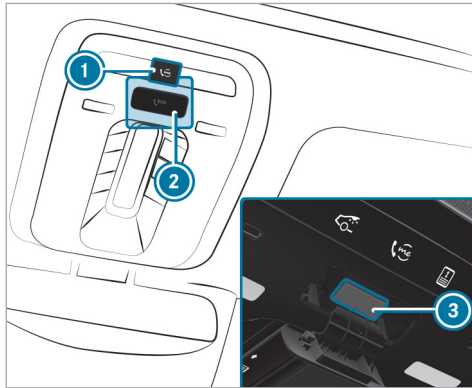

- ① me button for service or information calls
- ② SOS button cover
- ③ SOS button (emergency call system)

Making a Mercedes me call

- ▶ Press me button ①.

Making an emergency call

- ▶ To open the cover of SOS button ②, press it briefly.
- ▶ Press and hold SOS button ③ for at least one second.

If a Mercedes me call is active, an emergency call can still be triggered. This has priority over all other active calls.

■ Information about the Mercedes me call using the me button

A call to the Mercedes-Benz Customer Center has been initiated via the me button in the overhead control panel or the multimedia system (→ page 347).

Using the voice dialog system you access the desired service:

- Accident and Breakdown Management
- Mercedes-Benz Customer Center for general information about the vehicle

You can find information on the following topics:

- Activation of Mercedes me connect
- Operating the vehicle
- Nearest authorized Mercedes-Benz Center
- Other products and services from Mercedes-Benz

Data is transferred during the connection to the Mercedes-Benz Customer Center (→ page 349).

■ Calling the Mercedes-Benz Customer Center using the multimedia system

Requirements

- Access to a GSM network is available.
- The contract partner's GSM network coverage is available in the respective region.
- The vehicle must be switched on so that vehicle data can be transferred automatically.

Multimedia system:



▶ Call **Mercedes me connect**.

After confirmation, the multimedia system sends the required vehicle data. The data transfer is shown in the display.

Then you can select a service and be connected to a specialist at the Mercedes-Benz Customer Center.

■ **Calling the Mercedes-Benz Customer Center after automatic accident or breakdown detection**

Requirements:

- The vehicle has detected an accident or breakdown situation (→ page 227).
- The vehicle is stationary.
- The hazard warning lights are switched on.

ⓘ This function is not available in all countries.

The vehicle can detect accident or breakdown situations under certain circumstances.

Requirements for collision detection in the context of accident recovery:

- The vehicle is equipped with an anti-theft alarm system (ATA) (code 551).
- The vehicle is equipped with the interior protection (code 882).
- The vehicle is equipped with the Anti-Theft Protection Package (code P54).
- The collision detection service with theft notification has been activated on Mercedes me connect.

If a collision is detected when the tow-away alarm is primed on a locked vehicle, you will receive a notification in the multimedia system when you switch the vehicle on.

The message informs you about the potentially affected area of the vehicle and the strength of the collision.

In the event an accident or breakdown is detected, the emergency guide shows safety notes in the multimedia system display. This may take a few seconds.

ⓘ The availability of collision detection depends on the vehicle.

After quitting the emergency guide display on the multimedia system, a prompt appears asking whether you would like to get support from the Mercedes-Benz Customer Center.

▶ Select **Call**.

- After your agreement, or if the Mercedes me connect service "Accident and Breakdown Management" is active, the vehicle data is transferred automatically (→ page 351).
- The Mercedes-Benz Customer Center takes your call and organizes the breakdown and accident assistance.

You may be charged for these services.

ⓘ Depending on the severity of the accident, an automatic emergency call can be initiated. This has priority over all other active calls (→ page 354).

- ❶ In addition, if the Mercedes me connect service "Telediagnosics" is active, a similar prompt can appear after a delay in the event of a breakdown. If you are already in contact with the Mercedes-Benz Customer Center or have already received support, this prompt can be ignored or declined.
- ❷ If you answer the prompt for support from the Mercedes-Benz Customer Center with **Call Later**, the message will be hidden and appear again later.
The prompt triggered by the Mercedes me connect service "Telediagnosics", can either be confirmed or declined. After being declined, this will not be shown again.

■ Arranging a service appointment via a Mercedes me call

If you have activated the maintenance management service, relevant vehicle data is transferred automatically to the Mercedes-Benz Customer Center. You will then receive individual recommendations regarding the maintenance of your vehicle.

Regardless of whether you have consented to the maintenance management service, the multimedia system reminds you after a certain amount of time that a service is due. A prompt appears asking if you would like to make an appointment.

▶ **To arrange a service appointment:** select **Call**. After your consent, the vehicle data is transferred and the Mercedes-Benz Customer Center takes your preferred appointment date. The information is then sent to your desired service outlet.

This will contact you to confirm the appointment and if necessary consult about the details.

- ❶ If you select **Call Later** after the service message appears, the message is hidden and reappears at a later time.

■ Data transferred during a Mercedes me call

If you initiate a service call using Mercedes me, data is transferred to enable targeted advice and an efficient service.

The following requirements must be fulfilled for the transfer of the data:

- The vehicle is switched on.
- The required data transfer technology is supported by the mobile phone network provider.
- The quality of the mobile connection is sufficient.

Multi-stage transfer depends on the following factors:

- Reason for the initiation of the call
- The available mobile phone transmission technology
- The activated Mercedes me connect services
- The service selected in the voice control system

- ❶ The scope of the transmitted data depends on the vehicle model and its equipment. For technical reasons, not all data is available at all times.

Data transfer if Mercedes me connect services are not activated

If no Mercedes me connect services are activated, the following data is transferred:

- Vehicle identification number
- Time of the call
- Reason for the initiation of the call
- Confirmation of the data protection prompt
- Country indicator of the vehicle
- Set language for the multimedia system
- Telephone number of the communication platform installed in the vehicle

If a call is made for a service appointment via the service reminder, the following data is also transmitted:

- Current mileage and maintenance data

If a call is made after automatic accident or breakdown detection using the multimedia system, the following data is also transmitted:

- Current mileage and maintenance data

- Current vehicle location

If Accident and Breakdown Management is called via the voice control system, the following data can also be called up from the vehicle by the Mercedes-Benz Customer Center:

- Current vehicle location

Data processing

The data transmitted within the scope of the call is deleted from the processing system after the call is finished, in so far as this data is not being used for other activated Mercedes me connect services.

The incident-specific data is processed and stored in the Mercedes-Benz Customer Center and, if required to process the incident, forwarded to the service partner authorized by the Mercedes-Benz Customer Center. Take note of the data protection information on the Mercedes me Internet page <https://www.mercedes.me> or in the recorded message immediately after calling the Mercedes-Benz Customer Center.

 The recorded message is not available in every country.

Mercedes me connect

Information on Mercedes me connect

Mercedes me connect consists of multiple services.

You can use the following services via the multimedia system and the overhead control panel, for example:

- Accident and Breakdown Management (me button or situation-dependent display in the multimedia system)
- Mercedes-Benz Emergency Call System (automatic emergency call and SOS button)

The Mercedes me connect Accident and Breakdown Management and the Mercedes-Benz emergency call center are available to you around the clock.

The me button and the SOS button can be found on the vehicle's overhead control panel (→ page 347).

You can also call the Mercedes-Benz Customer Center using the multimedia system (→ page 347).

Please note that Mercedes me connect is a Mercedes-Benz service. In emergencies, first call the national emergency services using the standard national emergency service telephone numbers. In emergencies, you can also use the Mercedes-Benz emergency call system (→ page 354).

Please note the Mercedes me connect terms of use and the data protection information for Mercedes me connect. You can find these in your Mercedes me user account.

Further information about Mercedes me connect services can be obtained in the Mercedes me Portal: <https://me.secure.mercedes-benz.com>

■ Information on Mercedes me connect Accident and Breakdown Management

- ⓘ Accident and Breakdown Management is not available in every country. Contact an authorized Mercedes-Benz Center to find out whether this function is available in your country.

The Accident and Breakdown Management can include the following functions:

- Supplement to the Mercedes-Benz emergency call system (→ page 354)
If necessary, the contact person at the Mercedes-Benz emergency call center forwards the call to Mercedes me connect Accident and Breakdown Management. Forwarding the call is however not possible in all countries.
- Breakdown assistance by a technician on location and/or the towing away of the vehicle to the nearest authorized Mercedes-Benz Center
You may be charged for these services.
- Addition to the emergency guide after automatic accident or breakdown detection (→ page 348)
In the event of a breakdown or accident, further vehicle data is sent which enables optimal support by the Mercedes-Benz Customer Center and the authorized service partner or breakdown assistance.

- Addition to the Mercedes me connect service Telediagnosics
With the Telediagnosics function, specific wear and failure reports are recorded by the service provider, in so far as these can be clearly interpreted and are available through the monitoring of components that are subject to diagnostics.
If your vehicle detects a breakdown or threat of a breakdown, you may be prompted via the multimedia system to contact the Mercedes-Benz Customer Center for further help. This prompt in the multimedia system only appears when the vehicle is stationary.
- ⓘ These services are subject to technical restrictions such as the mobile phone coverage, mobile network quality and the ability of the processing systems to interpret the transferred data. In some circumstances, this can result in delays or the failure of the information to appear in the multimedia system.
Please note that the service and breakdown call is a Mercedes-Benz service. In emergencies, be sure to contact the usual national emergency

number first or use the Mercedes-Benz emergency call system (→ page 353).

More information about Mercedes me connect services can be obtained in the Mercedes me Portal: <https://me.secure.mercedes-benz.com>

■ Data transferred during Mercedes me connect call services

The data transferred during a Mercedes me connect call depends on:

- The reason for initiation of the call
- The service that is selected in the voice control system
- The activated Mercedes me connect services

You can find out which data is transferred when using the services in the currently valid Mercedes me connect terms of use and the data protection information for Mercedes me connect. You can find these in your Mercedes me user account.

Overview of the Mercedes me & Apps menu

When you log in with a user account to the Mercedes me Portal, then services and offers from Mercedes-Benz will be available to you.

For more information consult an authorized Mercedes-Benz Center or visit the Mercedes me Portal: <https://me.secure.mercedes-benz.com>

 Make sure you always keep the Mercedes me Apps updated.

You can call up the menu using **Apps** in the multimedia system.

In the **Apps** menu, the following options can be available:

- Connecting the vehicle with the **Mercedes me** user account
- Deleting a connection between a user account **Mercedes me** and the vehicle
- Calling up the Mercedes me services
- Calling up apps such as In-Car Office or the web browser depending on availability

Overview of Smartphone Integration

With Smartphone Integration, you can use certain functions on your mobile phone via the multimedia system display.

Only one mobile phone at a time can be connected via Smartphone Integration to the multimedia system. Also for use with two phone mode with Smartphone Integration, only one additional mobile phone can be connected using Bluetooth® with the multimedia system.

The full range of functions for Smartphone Integration is only possible with an internet connection. The appropriate application must be downloaded on the mobile phone to use Smartphone Integration. The mobile phone must be switched on and connected to the multimedia system via the USB port using a suitable cable.

Apps for Smartphone Integration:

- Apple CarPlay® (wireless connection via Bluetooth® also possible)
- Android Auto (wireless connection via Bluetooth® also possible)

- ⓘ For safety reasons, the first activation of Apple CarPlay® or Android Auto on the multimedia system must be carried out when the vehicle is stationary with the parking brake.

You can start Smartphone Integration using the **Devices** menu.

You can end Smartphone Integration via the **Devices** or by disconnecting the connecting cable between the mobile phone and multimedia system.

- ⓘ Mercedes-Benz recommends disconnecting the connection via the device manager or the connecting cable only when the vehicle is stationary.

Overview of transferred vehicle data

When using Smartphone Integration, certain vehicle data is transferred to the mobile phone. This enables you to get the best out of selected mobile phone services. Vehicle data is not directly accessible.

The following system information is transmitted:

- Software release of the multimedia system
- System ID (anonymized)

The transfer of this data is used to optimize communication between the vehicle and the mobile phone.

To do this, and to assign several vehicles to the mobile phone, a vehicle identifier is randomly generated.

This has no connection to the vehicle identification number (VIN) and is deleted when the multimedia system is reset (→ page 323).

The following driving status data is transmitted:

- Transmission position engaged
- Distinction between parked, standstill, rolling and driving
- Day/night mode of the driver display
- Drive type
- Vehicle temperature

The transfer of this data is used to alter how content is displayed to correspond to the driving situation.

The following position data is transmitted:

- Coordinates

- Speed
- Compass direction
- Acceleration direction
- Height

The mobile phone uses this data to improve the accuracy of navigation, for example, when driving through a tunnel.

Mercedes-Benz emergency call system

Information on the Mercedes-Benz emergency call system

Your vehicle is equipped with the Mercedes-Benz emergency call system (“eCall”). This feature can help save lives in the event of an accident. eCall in no way replaces assistance provided from dialing 911.

Mercedes-Benz eCall only functions in areas where mobile phone coverage is available from the wireless service providers. Insufficient network coverage from the wireless service providers may result in an emergency call not being transmitted.

eCall is a standard feature in your Mercedes-Benz vehicle. In order to function as intended, the system relies on the transmission of data detailed in the Transmitted Data section that follows.

To disable eCall, a customer must visit an authorized Mercedes-Benz Service department to deactivate the vehicle's communication module.

Deactivation of this module prevents the activation of any and all Mercedes me connect services. After the deactivation of eCall, automatic emergency call and manual emergency call will not be available.

The vehicle must be switched on before an automatic emergency call can be made.

i eCall is activated at the factory.

i eCall can be deactivated by an authorized Mercedes-Benz dealer. Please note that in the event ownership of the vehicle is transferred to another owner in its deactivated state, eCall will remain deactivated unless the new owner visits an authorized Mercedes-Benz dealership to reactivate the system.

Overview of the Mercedes-Benz emergency call system

eCall can help to reduce the time between an accident and the arrival of emergency services at the site of the accident. It helps locate an accident site in places that are difficult to access. However, even if a vehicle is equipped with eCall, this does not mean the system is ON. As such, eCall does not replace dialing 911 in the event of an accident.

An emergency call can be made automatically or manually.

Only make emergency calls if you or others are in need of rescue. Do not make an emergency call in the event of a breakdown or a similar situation.

Information on the display:

SOS NOT READY: the vehicle is not on or eCall not available.

During an active emergency call, <schar> appears in the display.

You can find more information on the regional availability of eCall at: <https://www.mercedes-benz-mobile.com/extra/ecall/>

i If there is a malfunction of the emergency call system, the loudspeakers, microphone, air bag or the SOS button, for example, are faulty.

You can recognize a malfunction in the emergency call system by the following displays:

- A corresponding message appears in the driver display.
- The SOS button lights up red continuously.

Triggering an automatic Mercedes-Benz emergency call

Requirements:

- The vehicle is switched on.
- The starter battery is sufficiently charged.

The Mercedes-Benz emergency call system triggers an emergency call automatically in the following cases:

- After activation of the restraint systems such as air bags or Emergency Tensioning Devices after an accident

- After an automatically initiated emergency stop by Active Emergency Stop Assist

The emergency call has been made:

- A voice connection is made to the Mercedes-Benz emergency call center.
- A message with accident data is transmitted to the Mercedes-Benz emergency call center.

The Mercedes-Benz emergency call center can transmit the vehicle position data to one of the emergency call centers.

The SOS button in the overhead control panel flashes until the emergency call is finished.

It is not possible to immediately end an automatic emergency call.

If no connection can be made to the emergency services either, a corresponding message appears in the media display.

- ▶ Dial the local emergency number on your mobile phone.

If an emergency call has been initiated:

- Remain in the vehicle if the road and traffic conditions permit you to do so until a voice

connection is established with the emergency call center operator.

- Based on the call, the operator decides whether it is necessary to call rescue teams and/or the police to the accident site.
- If no vehicle occupant answers, an ambulance is sent to the vehicle immediately.

Triggering a manual Mercedes-Benz emergency call

▶ **To use the SOS button in the overhead control panel:** press the SOS button at least one second long (→ page 347).

or

▶ **To use voice control:** use the voice commands of the MBUX Voice Assistant.

The emergency call has been made:

- A voice connection is made to the Mercedes-Benz emergency call center.
- A message with accident data is transmitted to the Mercedes-Benz emergency call center.

The Mercedes-Benz emergency call center can transmit the vehicle position data to one of the emergency call centers.

- Remain in the vehicle if the road and traffic conditions permit you to do so until a voice connection is established with the emergency call center operator.
- Based on the call, the operator decides whether it is necessary to call rescue teams and/or the police to the accident site.

If no connection can be made to the emergency services, a corresponding message appears in the central display.

- ▶ Dial the local emergency number on your mobile phone.

Ending an unintentionally triggered manual Mercedes-Benz emergency call

- ▶ Select  on the multifunction steering wheel. Depress button for several seconds.

Data transfer of the Mercedes-Benz emergency call system

In the event of an automatic or manual emergency call the following data is transmitted, for example:

- Vehicle's GPS position data
- GPS position data on the route (a few hundred meters () before the incident)
- Direction of travel
- Vehicle identification number
- Vehicle drive type
- Number of people detected in the vehicle
- Whether Mercedes me connect is available or not
- Whether the emergency call was initiated manually or automatically
- Time of the accident
- Language setting on the multimedia system

Data transmitted is vehicle information. For any questions about the collection, use and sharing of the eCall system data, please contact MBUSA's Customer Assistance Center at 800-FOR-MERC.

For Canada, please contact MBC's Customer Assistance Center at 1-800-387-0100.









Customer requests for covered information should be submitted via the same channels.





For accident clarification purposes, the following measures can be taken up to an hour after the emergency call has been initiated:

- The current vehicle position can be determined.
- A voice connection to the vehicle occupants can be established.

Radio & media

Overview of the symbols and functions in the media menu







Symbol	Designation	Function
	Play	Select to start or continue playback.
	Rest	Select to pause the playback.
	Repeat a track	Select to repeat the current track or the active playlist. <ul style="list-style-type: none"> • Select once: the active playlist is repeated. • Select twice: the current track is repeated. • Select three times: the function is deactivated.
	Random playback	Select to play back the tracks in random order.
	Skip forwards/back	Select to skip to the next or to the previous track.
	Additional options	Select to show additional options.
	Categories	Select to show and search through available categories such as playback lists, albums or artists.
	Search	Select to search in the active menu. You can search for artists, genres or moods, for example.

Symbol	Designation	Function
	Settings	Select to make settings.
	Home	Select to return to the home screen.
	Messaging	Select to call up messaging.
	Full screen	Select to switch to full screen mode.

The following functions and settings are available in the **Media** menu:





- Connecting external data storage media with the multimedia system (e.g. using USB or Bluetooth®)
- Playing back audio or video files

Overview of the symbols and functions in the radio menu

Symbol	Designation	Function
	Home	Select to return to the home screen.
	Messaging	Select to call up messaging.
	Skip forwards/back	Select to skip to the next or to the previous station.
	Settings	Select to have further options shown. The setting options are country-dependent.
HD	HD radio™	Select to switch the HD Radio™ function on or off. This function is not available in all countries.
	Station list	Select to have the station list shown.
	Search	Select to search in the active menu. You can search for artists, genres or moods, for example.

Additional functions of TuneIn Radio

-  A relatively large volume of data can be transmitted when using TuneIn Radio.

Symbol	Designation	Function
	Settings	The following additional settings are available in the TuneIn Radio menu: <ul style="list-style-type: none"> • Selecting stream • Logging on to or out of the TuneIn account
	Favorites	Select during playback to save the station currently set as a favorite.
	Play/Pause	Select to start, stop or continue playback.
	Browse	Select to choose a category and then a radio station.



Additional functions of the satellite radio

SIRIUS XM® satellite radio offers more than 175 digital-quality radio channels providing commercial-free music, sports, news and entertainment, for example. SIRIUS XM® satellite radio employs a fleet of high-performance satellites to broadcast

around the clock throughout the USA and Canada. The satellite radio program is available for a monthly fee. Information about this can be obtained from a Sirius XM® Service Center and at <https://www.siriusxm.com> (USA).

 Sirius, XM and all related marks and logos are trademarks of Sirius XM Radio Inc. and its subsidiaries. All other marks, channel names

and logos are the property of their respective owners. All rights reserved.

Symbol	Designation	Function
	Settings	The following additional settings are available in the satellite radio menu: <ul style="list-style-type: none"> • Activate child safety lock to lock channels with adult content • Set alarm program for music and sport alerts • Create TuneMix lists to listen to music seamlessly
	Play	Select to start or continue playback.
	Rest	Select to pause the playback.

Depending on the frequency band selected, different functions are available to you.

Select the desired frequency band in the radio menu head runner.

Sound settings

Overview of functions in the sound menu

The setting options and functions available depend on the sound system installed. You can find out which sound system is installed in your vehicle in the Digital Operator's Manual.

ASSYST PLUS service interval display

Function of the ASSYST PLUS service interval display

The ASSYST PLUS service interval display on the driver's display provides information on the remaining time or distance before the next service due date.

You can hide this service display using the back button  on the steering wheel.

Depending on how the vehicle is used, the ASSYST PLUS service interval display may shorten the service interval, e.g. in the following cases:

- Mainly short-distance driving
- When the engine is often left idling for long periods
- In the event of frequent cold start phases

Mercedes-Benz recommends avoiding such operating conditions.

You can obtain information concerning the servicing of your vehicle from a qualified specialist workshop, e.g. an authorized Mercedes-Benz Center.

Displaying the service due date

Driver display:



The next service due date is displayed.

To exit the display: press the back button  on the steering wheel.

Bear in mind the following related topic:

- Operating the driver display (→ page 296).

Information on regular maintenance work

! **NOTE** Premature wear through failure to observe service due dates

Maintenance work which is not carried out at the right time or incompletely can lead to increased wear and damage to the vehicle.

- ▶ Adhere to the prescribed service intervals.
- ▶ Always have the prescribed maintenance work carried out at a qualified specialist workshop.

Notes on special service requirements

The prescribed service interval is based on normal operation of the vehicle. Have the maintenance work carried out more often than prescribed if operating conditions are difficult or the vehicle is subject to increased stress.

The ASSYST PLUS service interval display is only an aid. It is the responsibility of the driver of the vehicle to have maintenance work carried out more often than prescribed due to actual operating conditions and/or stresses.

Examples of arduous operating conditions:

- Regular city driving with frequent intermediate stops
- Mainly short-distance driving
- Frequent operation in mountainous terrain or on poor road surfaces
- When the engine is often left idling for long periods
- Operation in particularly dusty conditions and/or if air-recirculation mode is frequently used

In these or similar operating conditions, have the interior air filter, air filter, engine oil and oil filter, for example, changed more frequently. If subject to increased stress, check the tires more. Further information can be obtained at a qualified specialist workshop.

Battery disconnection periods

The ASSYST PLUS service interval display can calculate the service due date only when the battery is connected.

- ▶ Display and note down the service due date on the driver display before disconnecting the battery (→ page 362).

Maintenance Management

Notes about Maintenance Management

If the Maintenance Management service is activated, relevant data is automatically transferred to the Mercedes-Benz customer center.

The customer center transmits the data to the service partner that you have entered on the

Mercedes me website at: <http://www.mercedes.me>. You will then receive individual recommendations regarding the maintenance of your vehicle.

- ① The calculation of the optimal transmission time of the maintenance request to the service partner is subject to technical limitations that may cause the maintenance recommendation to be perceived as too early or too late or not to be made at all. In this case, you can conveniently arrange a maintenance appointment with the customer center via the maintenance reminder in the multimedia system.
- ① Maintenance Management and the maintenance reminder in the multimedia system are not available in every country. Contact an authorized Mercedes-Benz Center to find out whether this function is available in your country.

Data transferred when using Maintenance Management

When the service is activated, relevant data is automatically transferred to determine the required scope of maintenance as well as malfunction detection and malfunction rectification.

Details on data transfer can be found in the data protection information for the Mercedes me connect services. These can be found at: <https://www.mercedes.me> under "My Account", "Data Protection & Legal Notice".

- ① Maintenance Management and the maintenance reminder in the multimedia system are not available in every country.

Telediagnosis

Notes about Telediagnosis

- ① This service is not available in all countries. The vehicle can detect if certain wear parts need to be replaced or if malfunctions have occurred in vehicle systems. If the Telediagnosis service is activated, relevant data is automatically transmit-

ted to the manufacturer. If fault conditions are detected by the vehicle system self-diagnosis, the system transmits recommendations for action to the Mercedes-Benz customer center depending on the fault detected. The customer center transmits the data to the service partner that you have entered on the Mercedes me website at: <http://www.mercedes.me>.

For selected faults, the notification that a malfunction has been detected may appear in the multimedia system with a request to contact the Mercedes-Benz customer center. From this message, a call can be made directly to the customer center for assistance.

- ① The transmission of a notification to the multimedia system depends on the country, vehicle model and equipment and requires a fast data connection, over which the service provider has no influence.
- ① Reliable fault detection is subject to technical limitations. Therefore, only a limited selection of faults can be detected and recommendations for action transmitted to the customer center and the service partners. Mercedes-Benz AG is continuously working on the

expansion of this service. The fault detection depends on the country, vehicle model and equipment.

Data transferred when using Telediagnosics

When the service is activated, relevant data is automatically transferred to determine the required scope of maintenance as well as malfunction detection and malfunction rectification.

Details on data transfer can be found in the data protection information for the Mercedes me connect services. These can be found at: <https://www.mercedes.me> under "My Account", "Data Protection & Legal Notice".

- ① The scope of the transmitted data depends on the vehicle model and its equipment. For technical reasons, not all data is available at all times.

Engine compartment

Opening and closing the hood

⚠ DANGER Risk of fatal injuries when carrying out maintenance work during the charging process

During the charging process, the high-voltage on-board electrical system is under high voltage.

- ▶ Do not perform any maintenance work during the charging process.

⚠ WARNING Risk of accident due to driving with the hood unlocked

The hood may open and block your view.

- ▶ Never release the hood when driving.
- ▶ Before every trip, ensure that the hood is locked.

⚠ WARNING Risk of accident and injury when opening and closing the hood

The hood may suddenly drop into the end position.

There is a risk of injury for anyone in the hood's range of movement.

- ▶ Do not open or close the hood if there is a person in the hood's range of movement.

⚠ WARNING Risk of burns when opening the hood

If you open the hood in the event of an overheated engine or fire in the engine compartment, the following situations may occur:

- You may come into contact with hot gases.
 - You may come into contact with other escaping hot operating fluids.
- ▶ Before opening the hood, allow the engine to cool down.

- ▶ In the event of a fire in the engine compartment, keep the hood closed and call the fire service.

⚠ WARNING Risk of injury due to moving parts

Components in the engine compartment may continue to run or start unexpectedly even when the drive system is switched off.

Observe the following if you must open the hood:

- ▶ Switch off the vehicle.
- ▶ Never touch the danger zones surrounding moving components, e.g. the rotation area of the fan.
- ▶ Remove jewellery and watches.
- ▶ Keep items of clothing and hair away from moving parts.

⚠ WARNING Risk of injury from touching live components

The ignition system and the fuel injection system operate with a high voltage. You could receive an electric shock.

- ▶ Never touch components of the ignition system or fuel injection system when the vehicle is switched on.

The live components include the following, for example:

- Ignition coils
- Fuel injectors
- Electric lines to the ignition coils and the fuel injectors

⚠ WARNING Risk of burns from hot component parts in the engine compartment

Certain component parts in the engine compartment can be very hot, e.g. the engine, the cooler and parts of the exhaust system.

- ▶ Allow the engine to cool down and only touch component parts described in the following.

⚠ WARNING Risk of injury from using the windshield wipers when the hood is open

If the windshield wipers start moving when the hood is open, you could be trapped by the wiper linkage.

- ▶ Always switch off the windshield wipers and the vehicle first if you need to open the hood.

Opening the hood

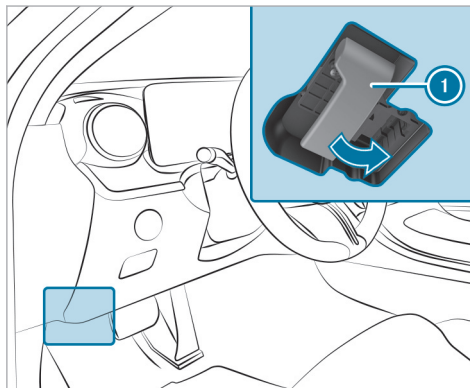

- ▶ To release the hood, pull on handle ①.

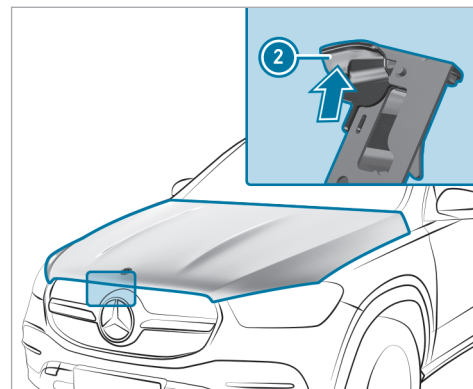

- ▶ Push handle ② of the hood catch upwards and lift the hood until it opens automatically.

Closing the hood

! NOTE Damage to the hood due to pressing the hood closed with your hand

If the hood is closed manually, there is a risk of dents.

▶ Do not close the hood manually.

- ▶ Lower the hood to a height of around 8 in (20 cm) and then allow it to fall, applying a little force as you let it go.
- ▶ If the hood can still be lifted slightly, open the hood again and close it with a little more force until it engages correctly.

Engine oil

■ Checking the engine oil level using the driver's display

Requirements

- The engine has been warmed up.
- The vehicle is parked on a level surface.
- The engine is running at idle speed.
- The hood is closed.

Determining the engine oil level can take up to 30 minutes with a normal driving style and even longer with an active driving style.

Driver display:



The engine oil level is shown.

One of the following messages will appear on the driver's display:

- **Engine Oil Level Measuring Now....**: the engine oil level cannot be determined yet.
- ▶ Repeat the request after a maximum of 30 minutes' driving.
- **Engine Oil Level OK** and the bar display for indicating the engine oil level on the driver's display is green and is between "min" and "max": the engine oil level is correct.
- **Engine Oil Level Refill 1,0 liq.gal.** and the bar display for indicating the engine oil level on the driver's display is yellow and is below "min":
- ▶ Add 1.1 US qt (1 l) of engine oil.
- **Engine Oil Level Reduce** and the bar display for indicating the engine oil level on the driver's display is yellow and is above "max":

▶ Drain off any excess engine oil that has been added. To do so, consult a qualified specialist workshop.

- **For Engine Oil Level Switch on Vehicle**
- ▶ Switch on the vehicle to check the engine oil level.
- **Engine Oil Level System Inoperative**: The oil level sensor is defective or not connected.
- ▶ Consult a qualified specialist workshop.
- **Engine Oil Level System Currently Unavailable**
- ▶ Close the hood.

■ Adding engine oil

⚠ WARNING Risk of burns from hot component parts in the engine compartment

Certain component parts in the engine compartment can be very hot, e.g. the engine, the cooler and parts of the exhaust system.

- ▶ Allow the engine to cool down and only touch component parts described in the following.

! WARNING Risk of fire and injury from engine oil

If engine oil comes into contact with hot component parts in the engine compartment, it may ignite.

- ▶ Make sure that no engine oil is spilled next to the filler opening.
- ▶ Allow the engine to cool off and thoroughly clean the engine oil from component parts before starting the vehicle.

! NOTE Engine damage caused by an incorrect oil filter, incorrect oil or additives

- ▶ Do not use engine oils or oil filters which do not correspond to the specifications explicitly prescribed for the service intervals.
- ▶ Follow the instructions on the service interval display for changing the engine

oil and observe the prescribed change intervals.

- ▶ Do not use additives.

! NOTE Damage caused by adding too much engine oil

Excessive engine oil can damage the engine or the catalytic converter.

- ▶ Have excess engine oil removed in a qualified specialist workshop.

- ① Depending on driving style, the vehicle will consume up to 0.9 US qt (0.8 liters) of oil per 600 miles (1000 km). The oil consumption may also be higher than this when the vehicle is new or if you frequently drive at high engine speeds.

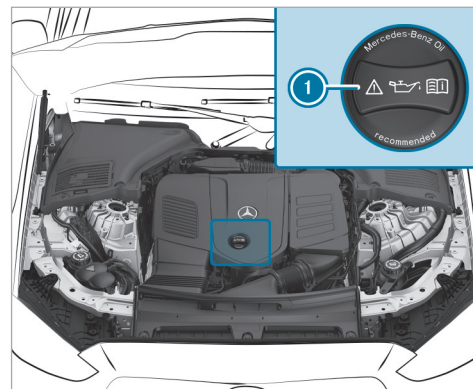

- ▶ Turn cap ① counter-clockwise and remove it.
- ▶ Add engine oil.
- ▶ Replace cap ① and turn it clockwise until it engages.
- ▶ Recheck the oil level (→ page 367).

Checking the coolant level

⚠ WARNING Risk of burns from hot component parts in the engine compartment

Certain component parts in the engine compartment can be very hot, e.g. the engine, the cooler and parts of the exhaust system.

▶ Allow the engine to cool down and only touch component parts described in the following.

⚠ WARNING Risk of scalding from hot coolant

If you open the cap, you could scald yourself.

- ▶ Allow the engine to cool down before opening the cap.
- ▶ When opening the cap, wear protective gloves and safety glasses.
- ▶ Open the cap slowly to release pressure.

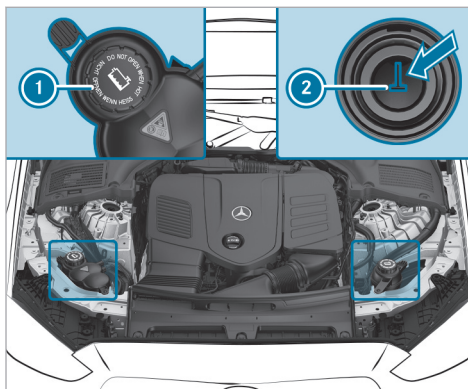

- ▶ Park the vehicle on a level surface.
- ▶ Check the coolant temperature display on the driver's display. The coolant temperature must be in the bottom quarter of the temperature display.
- ▶ Slowly turn cap ① counter-clockwise to release overpressure.

- ▶ Continue turning cap ① counter-clockwise and remove it.

The coolant level is correct in the following cases:

- if the engine is cold, the coolant is up to marker bar ②.
 - if the engine is warm, the coolant is up to 0.6 in (1.5 cm) over the marker bar ②.
- ▶ If necessary, add coolant that has been approved for Mercedes-Benz.
- ① Further information on coolant (→ page 445).

Refilling the windshield washer system

⚠ WARNING Risk of injury due to moving parts

Components in the engine compartment may continue to run or start unexpectedly even when the drive system is switched off.

Observe the following if you must open the hood:

- ▶ Switch off the vehicle.

- ▶ Never touch the danger zones surrounding moving components, e.g. the rotation area of the fan.
- ▶ Remove jewelry and watches.
- ▶ Keep items of clothing and hair away from moving parts.

⚠ WARNING Risk of burns from hot component parts in the engine compartment

Certain component parts in the engine compartment can be very hot, e.g. the engine, the cooler and parts of the exhaust system.

- ▶ Allow the engine to cool down and only touch component parts described in the following.

⚠ WARNING - Risk of fire and injury from windshield washer concentrate

Windshield washer concentrate is highly flammable. It could ignite if it comes into contact with hot engine component parts or the exhaust system.

- ▶ Make sure that no windshield washer concentrate spills out next to the filler opening.

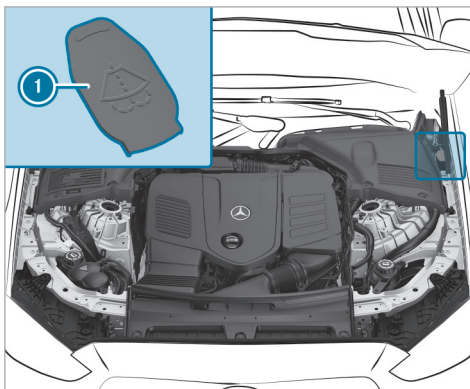

- ▶ Open cap ① by the tab.

- ▶ Add washer fluid.

① Further information about the windshield washer fluid (→ page 446).

Keeping the air/water duct free

- ▶ Keep the area between the hood and the windshield free of deposits, e.g. ice, snow or leaves.

Cleaning and care

Information on washing the vehicle in a car wash

⚠ WARNING Risk of accident due to reduced braking effect after washing the vehicle

The braking effect is reduced after washing the vehicle.

- ▶ After the vehicle has been washed, brake carefully while paying attention to the traffic conditions until the braking effect has been fully restored.

! NOTE Damage from automatic braking

If one of the following functions is activated, the vehicle will brake automatically in certain situations:

- Active Brake Assist
- Active Distance Assist DISTRONIC
- HOLD function
- Active Parking Assist

To avoid damage to the vehicle, switch off these systems, e.g. when towing or using a car wash.

! NOTE Damage due to unsuitable car wash

- ▶ Before driving into a car wash make sure that the car wash is suitable for the vehicle dimensions.
- ▶ Ensure there is sufficient ground clearance between the underbody and the guide rails of the car wash.

- ▶ Ensure that the clearance width of the car wash, in particular the width of the guide rails, is sufficient.

To avoid damage to your vehicle when using a car wash, ensure the following beforehand:

- Active Distance Assist DISTRONIC is deactivated.
- The HOLD function is switched off.
- The 360° camera or the reversing camera is switched off.
- The side windows and sliding sunroof are completely closed.
- The exterior mirrors are folded in.
- The blower for the ventilation and heating is switched off.
- The windshield wiper switch is in position **0**.
- The key is at a minimum distance of 10 ft (3 m) away from the vehicle. Otherwise the trunk lid could open unintentionally. This also applies to the Digital Vehicle Key.
- For car washes with conveyor systems:

- Neutral **N** is engaged.
- If you would like to leave the vehicle while it is being washed, make sure the key is located in the vehicle. Park position **P** will otherwise automatically be engaged.
- Do not make any hand movements in the area of the overhead control panel or deactivate the [Sliding Sunroof and Roller Sunblind](#) option in the settings for the MBUX interior assistant (→ page 312).
- ⓘ Removing the wax from the windshield and the wiper blades after washing the vehicle will help avoid smearing and reduce wiper noise.

Car wash mode

In car wash mode, the vehicle is configured in readiness for entering an automatic car wash. Car wash mode can be activated up to a speed of 12 mph (20 km/h) (→ page 372).

When car wash mode is activated, the **Automatic Car Wash Mode Active** message will appear on the driver display. The following adjustments will be made:

- The exterior mirrors will be folded in.
- To prevent the windshield washer system from starting up automatically, the rain sensor will be deactivated.
- Air-recirculation mode will be activated.
- Parking Assist PARKTRONIC will be deactivated.
- Active Brake Assist will be deactivated, if applicable.
- **Vehicles with 360° camera:** the front image will be activated after approximately eight seconds.
- **Vehicles with HANDS-FREE ACCESS:** kick detection will be deactivated.

If one of the settings cannot be selected, this will be indicated by a **X** after the respective setting.

Pressing **Switch Off** will cancel car wash mode. Car wash mode will automatically be deactivated above a speed of 12 mph (20 km/h).

You can also switch off car wash mode via the MBUX multimedia system (→ page 372).

The following settings will be reset when car wash mode is deactivated:

- The exterior mirrors will be folded out.
- The rain sensor will be activated.
- Air-recirculation mode will be deactivated.
- Parking Assist PARKTRONIC will be reset to the previously selected setting.
- Active Brake Assist will be activated, if applicable.
- **Vehicles with 360° camera:** the front image will be deactivated at speeds above 11 mph (18 km/h).
- **Vehicles with HANDS-FREE ACCESS:** kick detection will be activated.

Activating/deactivating Car Wash Mode

Requirements

- The vehicle is stationary.
- The vehicle is switched on.

Multimedia system:

↳  **Settings** **»** **Vehicle** **»** **Driving**

Activating car wash mode

- ▶ Select **Automatic Car Wash Mode**.
- ▶ Select **Activate**.

If one of the settings cannot be selected, this will be shown by a **X** next to the respective setting.

 For an overview of the settings made when you activate car wash mode (→ page 370).

Deactivating car wash mode

- ▶ Select **Deactivate**.
- ▶ The settings of car wash mode will be reset.
-  Car wash mode will automatically be deactivated as soon as your speed exceeds 12 mph (20 km/h).

Information on using a power washer

⚠ WARNING Risk of an accident when using power washers with round-spray nozzles

The water jet can cause externally invisible damage.

Components damaged in this way may unexpectedly fail.

- ▶ Do not use a power washer with round-spray nozzles.
- ▶ Have damaged tires or chassis parts replaced immediately.

To avoid damage to your vehicle, observe the following when using a power washer:

- The key is at a minimum distance of 10 ft (3 m) away from the vehicle. Otherwise the trunk lid could open unintentionally.
This also applies to the Digital Vehicle Key.
- Maintain a distance of at least 11.8 in (30 cm) to the vehicle.
- **Vehicles with decorative films:** Parts of your vehicle are covered with a decorative film.

Maintain a distance of at least 27.6 in (70 cm) between the film-covered parts of the vehicle and the nozzle of the power washer. Move the nozzle of the power washer around while cleaning. The water temperature of the power washer must not exceed 140°F (60°C).

- Observe the information on the correct distance in the equipment manufacturer's Operator's Manual.
- Do not direct the nozzle of the power washer directly at sensitive parts, e.g. tires, gaps, electrical components, batteries, illuminants or louvres.

Washing the vehicle by hand

! **NOTE** Engine damage due to water ingress

- ▶ Take care not to point the water jet directly towards the air inlet grille below the hood.

Observe the relevant legal requirements (e.g. in some countries, washing by hand is permitted only in specially designated wash bays).

- ▶ Use a mild cleaning agent, e.g. car shampoo.
 - ▶ Do not use acidic cleaning agents.
 - ▶ Wash the vehicle with lukewarm water using a soft car sponge. When doing so, do not expose the vehicle to direct sunlight.
 - ▶ Carefully hose the vehicle off with water and dry using a chamois.
- i** Observe the notes on the care of vehicle parts (→ page 375).

Notes on paintwork/matte finish paintwork care

To avoid damaging the paintwork and interfering with the driving assistance systems, please observe the following notes:

Paint

- Insect remains: soak with insect remover and rinse off the treated areas afterwards.
- Bird droppings: soak with water and rinse off afterwards.
- Tree resin, oils, fuels and greases: remove by rubbing gently with a cloth soaked in petroleum ether or lighter fluid.

- Coolant and brake fluid: remove with a damp cloth and clean water.
- Tar stains: use tar remover.
- Wax: use silicone remover.
- Do not attach stickers, films or similar materials. Only have film attached to the bumper at a qualified specialist workshop.
- Remove dirt immediately, where possible. Do not use acidic solutions and acidic cleaning agents.

Matte finish

- Only use care products approved for Mercedes-Benz.
- Do not attach stickers, films or similar materials. Only have film attached to the bumper at a qualified specialist workshop.
- Do not polish the vehicle or the light-alloy wheels.
- Only use car washes that correspond to the latest engineering standards.
- Do not use a car wash program with a final hot wax treatment.

- Do not use paint cleaners, buffing or polishing products, gloss preservers, e.g. wax.

In the event of paintwork damage:

- Always have paintwork repairs carried out at a qualified specialist workshop.
- Make sure the radar sensors function (→ page 229).

Notes on cleaning decorative car films

Please observe the "Notes on paintwork / matt paintwork care" (→ page 373). These notes also apply for matt decorative car films.

To avoid damage, please observe the notes on cleaning decorative car films.

Cleaning

- When cleaning with a power washer, maintain a minimum distance of 27.6 in (70 cm) between the film-covered parts of the vehicle and the nozzle of the power washer.
- To clean, use lots of water and a mild cleaning agent without additional or abrasive products,

e.g. a car shampoo approved for Mercedes-Benz.

- Do not use any acidic cleaning agents.
- Remove dirt immediately, if possible. Avoid hard rubbing to avoid damaging the decorative car film irreparably.
- In case of dirt embedded in the surface or a dull decorative car film: use the 'Paint Cleaner' cleaning agent recommended and approved for Mercedes-Benz.
- Insect remains: Soak with insect remover and rinse off the treated areas afterwards.
- Bird droppings: Soak with water and rinse off afterwards.
- Dry vehicles covered with car film after every wash using a soft, absorbent cloth to prevent water stains.

Preventing damage to the decorative car film

- The durability and color of decorative car films are affected by:
 - Solar radiation
 - Temperature, e.g. heat gun

- Weather
- Stone chips and dirt
- Chemical cleaning products
- Products containing grease
- Do not use polishes on matt decorative car films. Polishing results in the film-covered surface developing a shine.
- Do not use wax on matt or structured decorative car films. This may result in permanent stains.

Scratches, corrosive deposits, etched areas and damage caused by inadequate care cannot always be completely repaired. In such cases, please contact a qualified specialist workshop.

For more information about special care and cleaning products, please contact the manufacturer.

Laminated surfaces may exhibit optical differences to surfaces which were not protected by a decorative film when the decorative film is removed.

- ⓘ Have work or repairs on decorative car film carried out at a qualified specialist workshop, e.g. a Mercedes-Benz Service Center.

Information on window films

! **NOTE** Damage to electronic components due to excess fluids

When window films have been retrofitted, fluids such as cleaning agents or water may run down and get behind trim parts of the vehicle interior and cause damage to electronic components.

- ▶ Use cleaning agents as sparingly as possible.
- ▶ Immediately absorb any excess fluids.

Notes on car parts cleaning and care

! **WARNING** Risk of entrapment if the windshield wipers are switched on while the windshield is being cleaned

If the windshield wipers are set in motion while you are cleaning the windshield or wiper blades, you can be trapped by the wiper arm.

- ▶ Always switch off the windshield wipers and the vehicle before cleaning the windshield or wiper blades.

! **NOTE** Damage caused by acidic cleaning agents

- ▶ Do not use acidic cleaning agents. Otherwise, the surfaces could be damaged.

To avoid damage to the vehicle, observe the notes on cleaning and care of the following car parts:

Windows

NOTE Damage to electronic components due to excess fluids

When cleaning the windows from the inside, fluids such as cleaning agents or water may run down and get behind trim parts of the vehicle interior and cause damage to electronic components.

- ▶ Use cleaning agents as sparingly as possible.
- ▶ Immediately absorb any excess fluids.

- Clean the windows inside and outside with a damp cloth and with a cleaning agent recommended for Mercedes-Benz.
 - Do not use dry cloths or abrasive or solvent-based cleaning agents to clean the insides of windows.
- i** After changing the wiper blades or treating the vehicle with wax, clean the windshield thoroughly with cleaning agents recommended for Mercedes-Benz. Failure to observe the

application instructions may result in damage, smear marks or glare spots.

- i** Remove external misting or dirt on the windshield in front of the multifunction camera. Otherwise, driving systems and driving safety systems may be impaired or unavailable (→ page 229).

Wheels and rims

- Use water and acid-free alloy wheel cleaners.
- Do not use acidic alloy wheel cleaners to remove brake dust. This could damage wheel bolts and brake components.
- To avoid corrosion of the brake discs and pads, drive the vehicle for a few minutes after cleaning before parking it. The brake discs and brake linings will warm up and dry out.

Wiper blades

- Move the wiper arms into the replacement position (→ page 152).
- With the wiper arms folded out, clean the wiper blades with a damp cloth.

- i** Note that the wiper blades are coated. The coating may leave residue on a cloth. Do not rub the wiper blades excessively or clean them too often.

Exterior lighting

- Clean the lenses with a wet sponge and mild cleaning agent (e.g. car shampoo).
- Use only cleaning agents or cleaning cloths that are suitable for plastic lenses.

Vehicle socket (high-voltage battery)

- Use clean water and a soft cloth to clean the vehicle socket.
- Do not use power washers or cleaning agents, such as soap.

Sensors

- Clean the sensors in the front and rear part of the vehicle with car shampoo, plenty of water and a soft cloth (→ page 229).
- When using a power washer, maintain a minimum distance of 11.8 in (30 cm).

Cameras

- Open the camera cover with the multimedia system (→ page 277).
 - Use clean water and a soft cloth to clean the camera lenses.
 - Do not use a power washer.
- i** Remove external misting or dirt on the windshield in front of the multifunction camera. Otherwise, driving systems and driving safety systems may be impaired or unavailable (→ page 229).

Notes on care of the interior

⚠ WARNING Risk of injury from plastic parts breaking off after the use of solvent-based care products

Care and cleaning products containing solvents can cause surfaces in the cockpit to become porous. When the airbags are deployed, plastic parts may break away.

▶ Do not use any care or cleaning products containing solvents to clean the cockpit.

⚠ WARNING Risk of injury or fatal injuries from bleached seat belts

Bleaching or dyeing seat belts can severely weaken them.

This can, for example, cause seat belts to tear or fail in an accident.

▶ Never bleach or dye seat belts.

ⓘ NOTE Property damage due to disinfectants

The interior includes a number of sensitive surfaces such as displays, plastics and leather.

Disinfectants can contain alcohol and other substances that penetrate and damage surfaces. Technology behind buttons and displays can also be damaged.

▶ Do not use disinfectant on interior surfaces.

To avoid damage to the vehicle, observe the following notes on cleaning and care:

Seat belts

- Clean with lukewarm and soapy water.
- Do not use chemical cleaning agents.
- Do not dry by heating them to over 176°F (80°C) or exposing them to direct sunlight.

Display

- Switch off the display and let it cool down.
- Clean the surface carefully with a microfiber cloth and a suitable display care product (TFT-LCD).
- Do not use any other agents.

Head-up display

- Clean with a soft, non-static, lint-free cloth.
- Do not use cleaning agents.

Plastic trim

- Clean with a damp microfiber cloth.
- For heavy soiling: Use a cleaning agent recommended for Mercedes-Benz.

- Do not attach stickers, films or similar materials.
- Do not allow cosmetics, insect repellent or sun cream to come in contact with the plastic trim.

Real wood and trim elements

- Clean with a microfiber cloth.
- Black piano-lacquer look: clean with a damp cloth and soapy water.
- For heavy soiling: Use a cleaning agent recommended for Mercedes-Benz.
- Do not use solvent-based cleaning agents, polishes or waxes.

Headliner

- Clean with a brush or dry shampoo.

Carpet

- Use a carpet and textile cleaning agent recommended for Mercedes-Benz.

Imitation leather steering wheel

- Clean the entire steering wheel with a damp cotton cloth and a 1% soap solution. Do not spot clean.

- Use cleaning and care products recommended for Mercedes-Benz.
- Do not use a microfiber cloth.
- Do not use oil-based cleaning and care products.

Steering wheel made of genuine leather or DINA-MICA

! NOTE Damage caused by wrong cleaners

▶ Do not use solvent-based cleaning agents such as tar remover or wheel cleaner; neither should you use polishes or waxes. Otherwise you may damage the finish.

- Clean with a damp cloth and a 1% soap solution and then wipe with a dry cloth.
- For heavy soiling: Use a cleaning agent recommended for Mercedes-Benz.
- Leather care: Use a leather care agent that has been recommended for Mercedes-Benz.
- Do not allow the leather to become too damp.

- Do not use a microfiber cloth.

i Leather is a natural product. It has natural surface characteristics, such as differences in structure, marks caused by growth and injury or subtle color differences. These surface characteristics are particular to leather, and are not material defects. Leather is also subject to a natural aging process, which changes the surface characteristics.

Genuine leather seat covers

- Vacuum up dirt such as crumbs or dust and then clean the seat covers with a damp cotton cloth and wipe down with a dry cloth. Regularly clean the seat covers.
- For heavy soiling: use a leather care agent recommended for Mercedes-Benz aftercare.
- Leather care: Use a leather care agent that has been recommended for Mercedes-Benz.
- Do not use a microfiber cloth.
- Do not allow the leather to become too damp.
- Do not use oil-based cleaning and care products.

- i** Leather is a natural product. It has natural surface characteristics, such as differences in structure, marks caused by growth and injury or subtle color differences. These surface characteristics are particular to leather, and are not material defects. Leather is also subject to a natural aging process, which changes the surface characteristics. Waves or wrinkling in the seat cover may occur due to the stress on the seat; this is caused by the natural leather material. Regular cleaning and care of the leather reduces soiling, wear marks and aging damage and thus significantly extends its life span. Clothing that can leave stains (e.g. jeans) may discolour the leather.

DINAMICA seat covers

- Vacuum up dirt such as crumbs or dust and then use a damp cloth to clean.
- Do not use a microfiber cloth.

Imitation leather seat covers

- Vacuum up dirt such as crumbs or dust and then use a damp cotton cloth and a 1% soap

solution to clean the entire seat cover. Do not spot clean.

- Use cleaning and care products recommended for Mercedes-Benz.
- Do not use a microfiber cloth.
- Do not use oil-based cleaning and care products.

Cloth seat covers

- Vacuum up dirt such as crumbs or dust and then use a damp microfiber cloth and a 1% soap solution to clean the entire seat cover. Do not spot clean.
- Use cleaning and care products recommended for Mercedes-Benz.
- Do not use oil-based cleaning and care products.

EASY-PACK trunk box

- Clean with a damp cloth.
- Do not use any alcohol-based thinners, gasoline or abrasive cleaning agents.

Emergency

Removing the safety vest

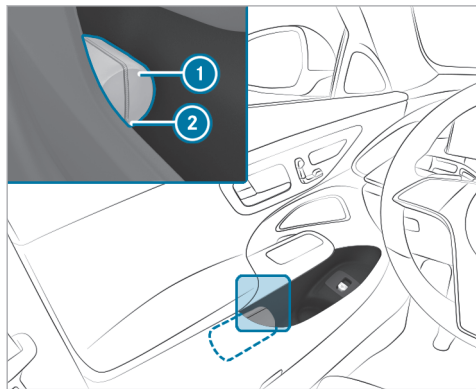

There is a safety vest stowage recess in the door stowage compartments of all doors for storing the safety vests.

- ▶ To remove: pull out the safety vest bag ① using the loop ②.

- ▶ Open the safety vest bag ① and pull out the safety vest.
- ▶ To replace: fold the safety vest, roll it up and insert it into the safety vest bag ①.
- ▶ Slide the safety vest bag ① along the underside of the armrest into the safety vest stowage recess. Ensure that the loop ② remains hanging out so that it is easy to grasp.

- ⓘ Remove the packaging film from a new safety vest before sliding it into the safety vest stowage recess. Otherwise, it may slide out unintentionally or the packaging may hinder its removal. Observe the legal requirements for the individual countries.

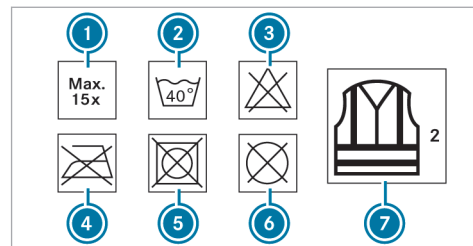

- ① Maximum number of washes
- ② Maximum wash temperature
- ③ Do not bleach
- ④ Do not iron
- ⑤ Do not tumble dry
- ⑥ Do not dry clean
- ⑦ Class 2 safety vest

The requirements defined by the legal standard are only fulfilled if the safety vest is the correct size and is fully closed.

Exchange the safety vest in the following cases:

- The reflective strips are damaged or dirty

- The maximum permissible number of washes is exceeded
- The fluorescence property decreases, e.g. due to permanent exposure to sunlight.

Dispose of the safety vest in an environmentally friendly way:

- Please contact your local waste disposal company.

Warning triangle

Removing the warning triangle

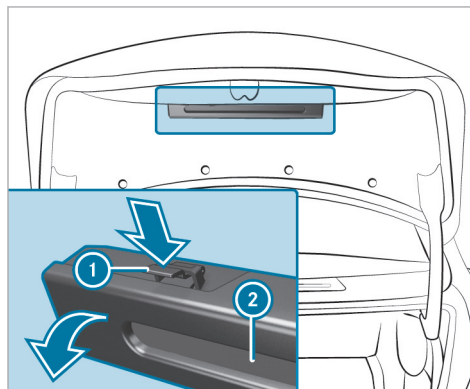

- ▶ Push both sides of the warning triangle holder ① in the direction of the arrow and open it.
- ▶ Remove the warning triangle ②.

The warning triangle is located in the trunk lid.

Setting up the warning triangle

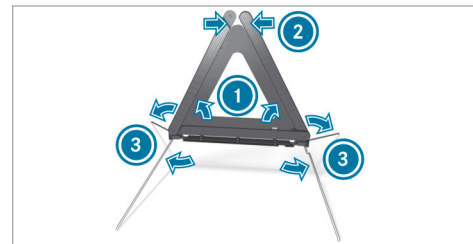

- ▶ Fold the side reflectors ① upwards to form a triangle and attach using the upper snap fastener ②.
- ▶ Fold the legs ③ down and out to the side.

First-aid kit (soft sided) overview

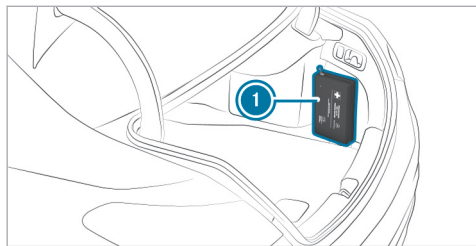

The first-aid kit (soft sided) ① is located on the left or right side of the trunk, depending on the respective vehicle version.

Flat tire

Notes on flat tires

⚠ WARNING Risk of accident due to a flat tire

A flat tire severely affects the driving characteristics as well as steering and braking.

Tires without run-flat characteristics:

- ▶ Do not drive on with a flat tire.
- ▶ Change the flat tire immediately with an emergency spare wheel or spare wheel. Alternatively, consult a qualified specialist workshop.

Tires with run-flat characteristics:

- ▶ Observe the information and warning notes on MOExtended tires (run-flat tires).

In the event of a flat tire, you have the following options depending on your vehicle's equipment:

- **Vehicles with MOExtended tires:** it is possible to continue your journey for a short period of time. Make sure you observe the notes on MOExtended tires (run-flat tires) (→ page 383).
- **Vehicles with a TIREFIT kit:** you can seal the tire so that it is possible to continue your journey for a short period of time. To do this, use the TIREFIT kit (→ page 384).
- **Vehicles with Mercedes me connect:** you can make a call for breakdown assistance via the

overhead control panel in the case of a breakdown (→ page 347).

- **All vehicles:** change the wheel (→ page 429).

i The emergency spare wheel is available only in certain countries (→ page 435).

Vehicles equipped with MOExtended tires are not equipped with a TIREFIT kit at the factory. It is therefore recommended that you additionally equip your vehicle with a TIREFIT kit if you mount tires on your vehicle that do not feature run-flat characteristics, e.g. winter tires. A TIREFIT kit may be obtained from a qualified specialist workshop.

Vehicles with a Mercedes-Benz emergency call system that are not equipped with a TIREFIT kit: in the event of a flat tire, contact the Customer Assistance Center for the Mercedes-Benz emergency call system .

Notes on MOExtended tires (run-flat tires)

▲ WARNING Risk of accident when driving in limp-home mode

When driving in emergency mode the handling characteristics are impaired.

- ▶ Do not exceed the specified maximum speed of the MOExtended tires.
- ▶ Avoid any abrupt steering and driving maneuvers as well as driving over obstacles (curbs, pot holes, off-road). This applies, in particular, to a loaded vehicle.
- ▶ Stop driving in the emergency mode if you notice:
 - Banging noise
 - Vehicle vibration
 - Smoke which smells like rubber
 - Continuous ESP® intervention
 - Cracks in the tire side walls
- ▶ After driving in emergency mode, have the rims checked by a qualified specialist

workshop with regard to their further use.

- ▶ The defective tire must be replaced in every case.

With MOExtended tires (run-flat tires), you can continue to drive your vehicle even if there is a total loss of pressure in one or more tires. However, the tire affected must not show any clearly visible damage.

You can recognize MOExtended tires by the MOExtended marking which appears on the side wall of the tire.

Vehicles with tire pressure loss warning system: MOExtended tires may only be used in conjunction with an activated tire pressure loss warning system.

Vehicles with tire pressure monitoring system: MOExtended tires may only be used in conjunction with an activated tire pressure monitoring system.

If a pressure loss warning message appears in the driver's display, proceed as follows:

- Check the tire for damage.
- If driving on, observe the following notes.

Driving distance possible in emergency mode after the pressure loss warning:

Load condition	Driving distance possible in emergency mode
Partially laden	50 miles (80 km)
Fully laden	19 miles (30 km)

The driving distance possible in emergency mode may vary depending on the driving style. Observe the maximum permissible speed of 50 mph (80 km/h).

If a tire has gone flat and cannot be replaced with an MOExtended tire, you can use a standard tire as a temporary measure.

TIREFIT kit storage location

Plug-in hybrid

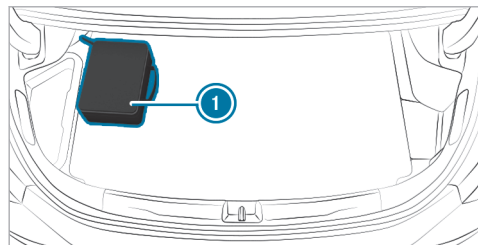

The TIREFIT kit ① is located on the left-hand side of the trunk in the as-delivered condition.

Not plug-in hybrid

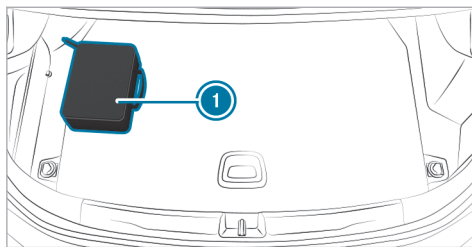

The TIREFIT kit ① is located on the left-hand side of the trunk in the as-delivered condition.

Depending on the vehicle version, the TIREFIT kit may be located in a different position in the trunk.

- ① Depending on the power category (LK), the tire inflation compressor weighs as follows:
- LK1 – 12 V/10 A, 120 W, 1.8 lbs (0.8 kg)
 - LK2 – 12 V/15 A, 180 W, 2 lbs (0.9 kg)

You can find information on the power category (LK) and/or electrical data on the back of the tire inflation compressor.

The tire inflation compressor is maintenance-free. In the event of a malfunction, please contact a qualified specialist workshop.

Using the TIREFIT kit

Requirements

- Tire sealant bottle and tire inflation compressor are ready for use (→ page 384).
- TIREFIT sticker is present.
- Gloves are present.

TIREFIT kit storage location: (→ page 384)

You can use TIREFIT tire sealant to seal perforation damage of up to 0.16 in (4 mm), particularly in the tire tread. You can use TIREFIT in outside temperatures down to -4 °F (-20 °C).

⚠ WARNING Risk of accident when using tire sealant

The tire sealant may be unable to seal the tire properly, especially in the following cases:

- There are large cuts or punctures in the tire (larger than damage previously mentioned)
- The wheel rims have been damaged
- After journeys with very low tire pressure or with flat tires

- ▶ Do not continue driving.
- ▶ Consult a qualified specialist workshop.

⚠ WARNING Risk of injury and poisoning from tire sealant

The tire sealant is harmful and causes irritation. Do not allow it to come into contact with the skin, eyes or clothing, and do not swallow it. Do not inhale tire sealant fumes. Keep the tire sealant away from children.

If you come into contact with the tire sealant, observe the following:

- ▶ Rinse off the tire sealant from your skin immediately using water.

- ▶ If tire sealant gets into your eyes, thoroughly rinse out the eyes using clean water.
- ▶ If tire sealant has been swallowed, immediately rinse out the mouth thoroughly and drink plenty of water. Do not induce vomiting and seek medical attention immediately.
- ▶ Change out of any clothes contaminated with tire sealant immediately.
- ▶ If allergic reactions occur, seek medical attention immediately.

! NOTE Overheating due to the tire inflation compressor running too long

- ▶ Do not run the tire inflation compressor for longer than ten minutes without interruption.

Comply with the manufacturer's safety notes on the sticker on the tire inflation compressor.

Have the tire sealant bottle replaced at a qualified specialist workshop every five years.

- ▶ Do not remove any foreign bodies that have entered the tire.

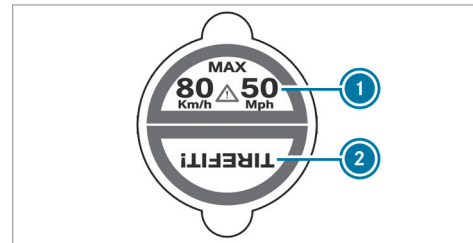

- ▶ Affix part ① of the TIREFIT sticker to the instrument cluster within the driver's field of vision.
- ▶ Affix part ② of the TIREFIT sticker near the valve on the wheel with the defective tire.

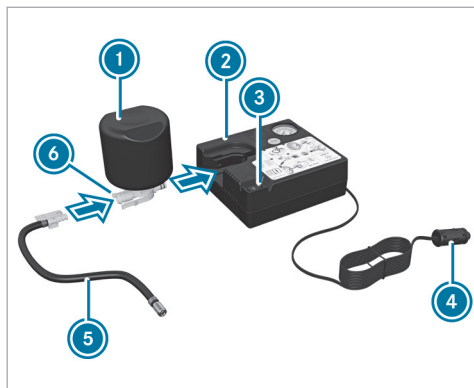

- ▶ Pull plug ④ with the cable and hose ⑤ out of the tire inflation compressor housing.
- ▶ Push the plug of hose ⑤ into flange ⑥ of tire sealant bottle ① until the plug engages.
- ▶ Insert tire sealant bottle ① head downwards into recess ② of the tire inflation compressor.



- ▶ Remove the valve cap from valve ⑦ on the defective tire.
- ▶ Screw filling hose ⑧ onto valve ⑦.
- ▶ Insert plug ④ into a 12 V socket in your vehicle.
- ▶ Switch on the vehicle.
- ▶ Press on and off switch ③ on the tire inflation compressor. The tire inflation compressor will be switched on. The tire will be inflated. First, tire sealant will be pumped into the tire. The pressure may briefly rise to approximately 500 kPa (5 bar/73 psi).

Do not switch off the tire inflation compressor during this phase!

- ▶ Let the tire inflation compressor run for a maximum of ten minutes. The tire should then have attained a tire pressure of at least 200 kPa (2.0 bar/29 psi).

If tire sealant leaks out, make sure you clean the affected area as quickly as possible. It is preferable to use clean water.

If you get tire sealant on your clothing, have it cleaned as soon as possible with perchloroethylene.

If, after ten minutes, a tire pressure of 200 kPa (2.0 bar/29 psi) has not been attained:

- ▶ Switch off the tire inflation compressor.
- ▶ Unscrew the filling hose from the valve of the defective tire.

Please note that tire sealant may leak out when you unscrew the filling hose.

- ▶ Drive forwards or in reverse very slowly for approximately 33 ft (10 m).

- ▶ Pump up the tire again.
After a maximum of ten minutes, the tire pressure must be at least 200 kPa (2.0 bar/29 psi).

⚠ WARNING Risk of accident due to the specified tire pressure not being achieved

If the specified tire pressure is not achieved after the specified time, the tire is too badly damaged. The tire sealant cannot repair the tire in this instance.

The braking characteristics as well as the driving characteristics may be greatly impaired.

- ▶ Do not continue driving.
- ▶ Consult a qualified specialist workshop.

If, after ten minutes, a tire pressure of 200 kPa (2.0 bar/29 psi) has been attained:

⚠ WARNING Risk of accident from driving with sealed tires

A tire temporarily sealed with tire sealant impairs the handling characteristics and is not suitable for higher speeds.

- ▶ Adapt your driving style accordingly and drive carefully.
- ▶ Do not exceed the maximum speed limit with a tire that has been repaired using tire sealant.

- ▶ Observe the maximum permissible speed of 50 mph (80 km/h) for a tire sealed with tire sealant.
- ▶ Affix the upper section of the TIREFIT sticker to the instrument cluster in a location where it will be easily seen by the driver.

! NOTE Staining caused by leaking tire sealant

After use, excess tire sealant may leak out from the filling hose.

- ▶ Therefore, place the filling hose in the plastic bag that contained the TIREFIT kit.

🔥 ENVIRONMENTAL NOTE Environmental pollution caused by environmentally irresponsible disposal

Tire sealant contains pollutants.

- ▶ Have the tire sealant bottle disposed of professionally, e.g. at an authorized Mercedes-Benz Center.

- ▶ Switch off the tire inflation compressor.
- ▶ Unscrew the filling hose from the valve of the defective tire.
- ▶ Stow the tire sealant bottle and the tire inflation compressor.
- ▶ Pull away immediately.

- ▶ Stop driving after approximately ten minutes and check the tire pressure using the tire inflation compressor. The tire pressure must now be at least 130 kPa (1.3 bar/19 psi).

⚠ WARNING Risk of accident due to the specified tire pressure not being attained

If the specified tire pressure is not reached, the tire is too badly damaged. The tire sealant cannot repair the tire in this instance.

The braking and driving characteristics may be greatly impaired.

- ▶ Do not continue driving.
- ▶ Consult a qualified specialist workshop.

In cases such as the one mentioned above, contact an authorized Mercedes-Benz Center. Or call 1-800-FOR-MERCEdes (in the USA) or 1-800-387-0100 (in Canada).

- ▶ Correct the tire pressure if it is still at least 130 kPa (1.3 bar/19 psi). See the Tire and Loading Information placard on the B-pillar on

the driver's side or the tire pressure table in the fuel filler flap for values.

- ▶ **To increase the tire pressure:** switch on the tire inflation compressor.

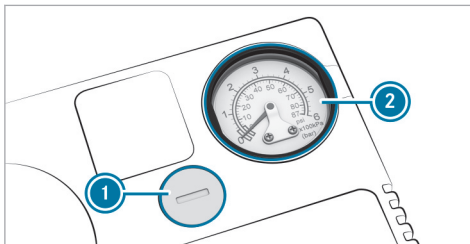

- ▶ **To reduce the tire pressure:** press pressure release button ① next to manometer ②.
- ▶ When the tire pressure is correct, unscrew the filling hose from the valve of the sealed tire.
- ▶ Screw the valve cap onto the valve of the sealed tire.

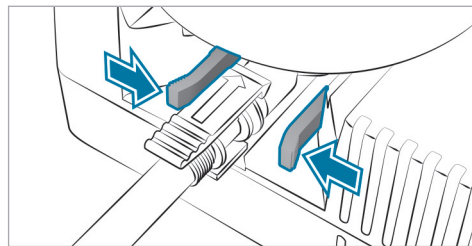

- ▶ Pull the tire sealant bottle out of the tire inflation compressor. Press the locking tabs on the yellow cap together to do this. The filling hose stays on the tire sealant bottle.
- ▶ Drive to the nearest qualified specialist workshop and have the tire, tire sealant bottle and filling hose replaced there.

Battery (vehicle)**Notes on the 12-V-battery**

⚠ WARNING Risk of an accident due to work carried out incorrectly on the battery

Work carried out incorrectly on the battery can, for example, lead to a short circuit. This can restrict functions relevant for safety systems and impair the operating safety of your vehicle.

You could lose control of the vehicle in the following situations in particular:

- When braking
- In the event of abrupt steering maneuvers and/or when the vehicle's speed is not adapted to the road conditions
- ▶ In the event of a short circuit or a similar incident, contact a qualified specialist workshop immediately.
- ▶ Do not drive on.
- ▶ Always have work on the battery carried out at a qualified specialist workshop.

- More information on ABS (→ page 231)
- Further information on ESP® (→ page 232)

For safety reasons, Mercedes-Benz recommends that you only use batteries which have been approved for your vehicle by Mercedes-Benz.

All vehicles except vehicles with a lithium-ion battery

⚠ WARNING Risk of explosion due to electrostatic charge

Electrostatic charge can ignite the highly explosive gas mixture in the battery.

- ▶ To discharge any electrostatic charge that may have built up, touch the metal vehicle body before handling the battery.

The highly flammable gas mixture is created while the battery is charging and during starting assistance.

⚠ WARNING Danger of chemical burns from the battery acid

Battery acid is caustic.

- ▶ Avoid contact with the skin, eyes or clothing.
- ▶ Do not lean over the battery.
- ▶ Do not inhale battery gases.
- ▶ Keep children away from the battery.
- ▶ Immediately rinse battery acid off thoroughly with plenty of clean water and seek medical attention immediately.

All vehicles

🌿 ENVIRONMENTAL NOTE Environmental damage due to improper disposal of batteries



Batteries contain pollutants. It is illegal to dispose of them with the household rubbish.



Dispose of batteries in an environmentally responsible manner. Take discharged batteries to a qualified specialist workshop or to a collection point for used batteries.

If you have to disconnect the 12-V-battery, contact a qualified specialist workshop.

Comply with safety notes and take protective measures when handling batteries.



Risk of explosion if the 12-V-battery is used improperly.



Fire, naked flames and smoking are prohibited when handling the battery. Avoid creating sparks.



Electrolyte or battery acid is corrosive. Avoid contact with the skin, eyes or clothing. Wear suitable protective clothing, in particular gloves, an apron and a face mask. Immediately rinse electrolyte or

acid splashes off with clean water. Consult a doctor.



Do not place heavy objects on the surface of the battery or use the battery to support a person in any way.



Wear safety glasses.



Keep children away.



Observe this Owner's Manual.

If you do not intend to use the vehicle over an extended period of time, observe the following:

- **If available:** activate standby mode (→ page 228, 229).
- Alternatively: connect the battery to a battery charger approved by Mercedes-Benz or consult a qualified specialist workshop to disconnect the battery.

Notes on the 48-V-battery

⚠ WARNING Risk of an accident due to work carried out incorrectly on the battery

Work carried out incorrectly on the battery can, for example, lead to a short circuit. This can restrict functions relevant for safety systems and impair the operating safety of your vehicle.

You could lose control of the vehicle in the following situations in particular:

- When braking
- In the event of abrupt steering maneuvers and/or when the vehicle's speed is not adapted to the road conditions

▶ In the event of a short circuit or a similar incident, contact a qualified specialist workshop immediately.

▶ Do not drive on.

▶ Always have work on the battery carried out at a qualified specialist workshop.

- More information on ABS (→ page 231)

- Further information on ESP® (→ page 232)



ENVIRONMENTAL NOTE Environmental damage due to improper disposal of batteries



Batteries contain pollutants. It is illegal to dispose of them with the household trash.



Li-ion Dispose of batteries in an environmentally responsible manner. Take discharged batteries to a qualified specialist workshop or to a collection point for used batteries.

Only have work on the 48-V-battery carried out at a qualified specialist workshop.

Comply with safety notes and take protective measures when handling batteries.



Risk of explosion if the 48-V-battery is used improperly.



The surface of the 48-V-battery may be hot.



Fire, naked flames and smoking are prohibited when handling the battery. Avoid creating sparks.



Electrolyte or battery acid is corrosive. Avoid contact with the skin, eyes or clothing. Wear suitable protective clothing, in particular gloves, an apron and a face mask. Immediately rinse off splashes of electrolyte or acid with plenty of clean water. Consult a doctor.



Do not place heavy objects on the surface of the battery or use the battery to support a person in any way.



Do not perform any work on the battery. Always have any work on the battery carried out at a qualified specialist workshop. Do not disconnect the battery yourself. Do not remove the battery yourself. Do not attempt to open the battery.



Keep children away.



Wear safety glasses.



Observe this Owner's Manual.

If you do not intend to use the vehicle over an extended period of time, observe the following:

- **If available:** activate standby mode (→ page 228, 229).

Notes on the high-voltage battery



DANGER Risk of fire and explosion from excessive internal pressure of the high-voltage battery

In the event of a vehicle fire, flammable gas can escape and ignite.

▶ If there is an unusual smell, smoke or burn marks, stop the charging process immediately.

- ▶ Leave the danger zone immediately. Secure the danger area at a sufficient distance.
- ▶ Call the fire service.

Observe the notes on charging the high-voltage battery (→ page 204).



Risk of explosion.



Fire, naked flames and smoking are prohibited when handling the battery. Avoid creating sparks.



Electrolyte or battery acid is corrosive. Avoid contact with the skin, eyes or clothing. Wear suitable protective clothing, in particular gloves, an apron and a face mask. Immediately rinse electrolyte or acid splashes off with clean water. Consult a doctor.



Wear safety glasses.



Keep children away.



Observe this Operator's Manual.

Notes on starting assistance and charging the 12-V-battery

All vehicles

Always use the jump-start connection point in the engine compartment for charging the battery and jump starting.



NOTE Damage to the battery due to over-voltage

When charging using a battery charger without a maximum charging voltage, the battery or the on-board electronics may be damaged.

- ▶ Only use battery chargers with a maximum charging voltage of 14.8 V.



WARNING Risk of explosion due to igniting hydrogen gas

If you cause a short circuit or sparks occur, the hydrogen gas may ignite when a battery is charging.

- ▶ Ensure that the positive terminal of a connected battery does not come into contact with vehicle parts.
- ▶ Never place metal objects or tools on a battery.
- ▶ When connecting and disconnecting the battery, always observe the sequence of battery terminals described.
- ▶ When jump starting, take care to connect only battery terminals of identical polarity.
- ▶ When jump starting, always observe the sequence described for connecting and disconnecting the jumper cables.
- ▶ Do not connect or disconnect the battery terminals when the engine is running.

⚠ WARNING Risk of explosion due to a mixture of explosive gases

A mixture of explosive gases can escape from the battery during charging and jump starting.

- ▶ Fire, open flames, smoking and creating sparks must be avoided.
- ▶ Make sure that there is sufficient ventilation.
- ▶ Do not stand over the battery.

⚠ WARNING Risk of explosion from a frozen battery

A discharged battery may freeze at temperatures slightly above or below freezing point.

During starting assistance or battery charging, battery gas can be released.

- ▶ Always allow a battery to thaw before charging it or performing starting assistance.

If the indicator/warning lamps in the instrument cluster do not light up at low temperatures, it is

very likely that the discharged battery has frozen. In this case you must neither charge the battery nor give the vehicle starting assistance.

The service life of a defrosted battery may be drastically shortened. The starting behaviour may deteriorate, in particular at low temperatures.

Having a defrosted battery checked at a qualified specialist workshop is recommended.

Plug-in hybrid

If your vehicle has been started with starting assistance, it may not be possible to use the electric drive for approximately 30 minutes.

Starting assistance is not considered to be a normal operating condition.

All vehicles

! **NOTE** Damage caused by numerous or extended attempts to start the engine

Numerous or extended attempts to start the engine may damage the catalytic converter due to non-combusted fuel.

- ▶ Avoid numerous and extended attempts to start the engine.

Observe the following points during starting assistance and when charging the battery:

- Only use undamaged jumper cables/charging cables with a sufficient cross-section and insulated terminal clamps.
- Uninsulated parts of the terminal clamps must not come into contact with other metal parts while the jumper cables/charging cables are connected to the battery/jump-start connection point.
- The jumper cables/charging cables must not touch any parts which may move when the engine is running.
- Make sure that neither you nor the battery are electrostatically charged.
- Avoid fire and naked lights.
- Do not bend over a battery.

When charging the battery also observe the following points:

- Only use chargers tested and approved for Mercedes-Benz.
- Read the charger's Owner's Manual before you charge the battery.

Also observe the following points during starting assistance:

- Starting assistance may only be provided using vehicles, batteries or other jump start devices with a nominal voltage of 12-V-.
- The vehicles must not touch each other.
- **Vehicles with a gasoline engine:** jump-start the vehicle only when the engine and exhaust system are cold.

Starting assistance and charging the 12-V-battery

Preparation for jump-starting/charging

- ▶ Use the electric parking brake to secure the vehicle.
- ▶ Shift the transmission to position **P**.

- ▶ Switch off the vehicle and all electrical consumers.
- ▶ Open the hood.

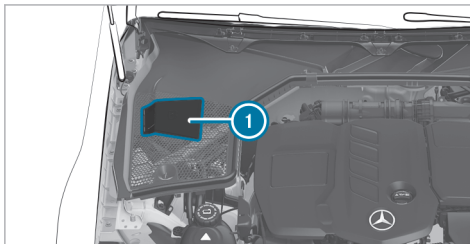

Example illustrations

- ▶ Open the cover ① of the jump-start connection point.

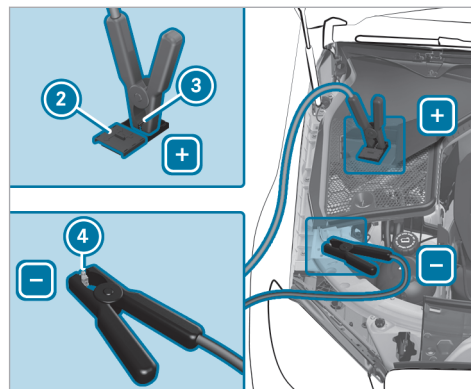

- ▶ Open the cover ② of the positive terminal ③ on the jump-start connecting point.

Starting assistance

- ▶ Connect the positive terminal ③ of your vehicle to the positive terminal of the donor battery using the jumper cable. Always begin with positive clamp ③ on your own vehicle first.

- ▶ On the assisting vehicle leave the engine running at idling speed.
- ▶ Connect the negative terminal of the donor battery to the ground point ④ of your vehicle using the jumper cable. Begin with the donor battery first.
- ▶ Start the engine of your own vehicle.
- ▶ Let the engines run for several minutes.
- ▶ Before disconnecting the jumper cable, switch on an electrical consumer in your own vehicle, e.g. the rear window heating or lighting.

When jump-starting has been completed:

- ▶ First disconnect the jumper cable from the ground point ④ and negative terminal of the donor battery, then from the positive terminal ③ of the donor battery. Begin each time with the contacts on your own vehicle first.
- ▶ Close the cover ② of the positive terminal ③ after removing the jumper cables.
- ▶ Close the cover ①.

If your vehicle has been started with starting assistance, it may not be possible to use the electric drive for approximately 30 minutes.

Further information can be obtained at a qualified specialist workshop.

Charging

- ▶ Connect the positive terminal ③ of the vehicle to the positive terminal of the charger using the charging cable. Always begin with positive terminal ③ of the vehicle.
- ▶ Connect the negative terminal of the charger to the ground point ④ of the vehicle using the charging cable. Make the charger connection first.
- ▶ Start the charging process.

When the charging process is complete:

- ▶ First, remove the charging cables from the ground point ④ and negative terminal of the charger, then from the positive terminal ③ of the charger. Begin each time with the contacts of the vehicle.

- ▶ Close the cover ② of the positive terminal ③ after removing the charging cables.
- ▶ Close the cover ①.

Further information can be obtained at a qualified specialist workshop.

Replacing the 12 V battery

- ▶ Observe the notes on the 12 V battery (→ page 389).

Mercedes-Benz recommends that you have the 12 V battery replaced at a qualified specialist workshop, e.g. at a Mercedes-Benz Service Center.

If you want to replace the battery yourself, observe the following notes:

- Replace a faulty battery with a battery which meets the specific vehicle requirements.
The vehicle is equipped with a battery with AGM -technology (Absorbent Glass Mat) or a lithium-ion battery. Full vehicle functionality is only guaranteed with an AGM battery or lithium-ion battery. For safety reasons, Mercedes-

Benz recommends that you only use batteries which have been tested and approved for your vehicle by Mercedes-Benz.

- Use the detachable parts such as vent hoses, elbow fittings or terminal covers from the battery which is to be replaced.
- Make sure that the vent hose is always connected to the original opening on the side of the battery.

Install any existing or supplied cell caps.

Otherwise, gases or battery acid could escape.

- Make sure that detachable parts are reconnected in the same way.

Tow starting or towing away

Permitted towing methods (not plug-in hybrid)

! NOTE Damage from automatic braking

If one of the following functions is activated, the vehicle will brake automatically in certain situations:

- Active Brake Assist
- Active Distance Assist DISTRONIC
- HOLD function
- Active Parking Assist

To avoid damage to the vehicle, switch off these systems, e.g. when towing or using a car wash.

Mercedes-Benz recommends transporting your vehicle in the case of a breakdown, rather than towing it away.

For towing with both axles on the ground, use a tow rope or tow rod. Do not use tow bar systems.

! NOTE Damage to the vehicle due to towing away incorrectly

▶ Observe the instructions and notes on towing away.

Vehicles with rear-wheel drive

Permitted towing methods

Both axles on the ground	Yes, for a maximum of 31 miles (50 km) at 31 mph (50 km/h)
Front axle raised	No
Rear axle raised	Yes, if the steering wheel is fixed in the center position with a steering wheel lock



4MATIC vehicles

Permitted towing methods	
Both axles on the ground	Yes, for a maximum of 31 miles (50 km) at 31 mph (50 km/h)
Front axle raised	No
Rear axle raised	No

Towing with a raised axle: towing should be performed by a towing company.



Permitted towing methods (plug-in hybrid)

 The information below does not apply to Mercedes-AMG E Performance vehicles.

 NOTE Mercedes-AMG vehicles
 Observe the notes in the Supplement. You could otherwise fail to recognize dangers.

Mercedes-Benz recommends transporting your vehicle in case of a breakdown, rather than towing it.

For towing with both axles on the ground, use a tow rope or tow bar. Do not use tow bar systems.

 NOTE Damage to the vehicle due to towing away incorrectly
 Observe the instructions and notes on towing away.

Observe the information on towing and transporting the vehicle in the vehicle Operator's Manual. In the following situations, only transporting the vehicle is permitted:

- The driver display is not working.
- The driver display shows the message  **Towing Not Permitted See Operator's Manual**.

Exception: if the vehicle is located in a danger zone, it can be recovered from the danger zone despite the display message  **Towing Not Permitted See Operator's Manual** or the display

not working. It must not be towed further than 55 yd (50 m) with both axles on the ground. A towing speed of 6 mph (10 km/h) must not be exceeded. Beyond these limits, only transporting is permitted.

Vehicles with rear wheel drive

Permitted towing methods	
Both axles on the ground	Yes, for a maximum of 31 miles (50 km) at 31 mph (50 km/h), only forwards with the driver on board
Front axle raised	No
Rear axle raised	Yes, if the steering wheel is fixed in the center position with a steering wheel lock

4MATIC vehicles

Permitted towing methods

Both axles on the ground	Yes, for a maximum of 31 miles (50 km) at 31 mph (50 km/h), only forwards with the driver on board
Front axle raised	No
Rear axle raised	No

Towing the vehicle with both axles on the ground

- ▶ Observe the notes on the permitted towing methods.
- ▶ Make sure that the battery is connected and charged.

Observe the following points when the battery is discharged:

- The vehicle cannot be started.
- The electric parking brake cannot be released or applied

- **Vehicles with automatic transmission:** the transmission cannot be shifted to position **[N]** or **[P]**.

- ⓘ **Vehicles with automatic transmission:** if the transmission cannot be shifted to position **[N]** or if the display does not show anything, transport the vehicle (→ page 399). A towing vehicle with lifting equipment is required for vehicle transportation.

! **NOTE** Damage due to towing away at excessively high speeds or over long distances

The drivetrain could be damaged when towing at excessively high speeds or over long distances.

- ▶ A towing speed of 30 mph (50 km/h) must not be exceeded.
- ▶ A towing distance of 30 miles (50 km) must not be exceeded.

▲ **WARNING** Risk of accident when towing a vehicle which is too heavy

If the vehicle to be tow-started or towed away is heavier than the permissible gross mass of your vehicle, the following situations can occur:

- The towing eye may become detached.
 - The vehicle/trailer combination may swerve or rollover.
- ▶ Before tow-starting or towing away, check if the vehicle to be tow-started or towed away exceeds the permissible gross mass.

If a vehicle has to be tow-started or towed away, its gross vehicle weight rating must not exceed the gross vehicle weight rating of the towing vehicle.

- ▶ Information on the gross vehicle weight rating can be found on the vehicle identification plate (→ page 439).
- ▶ **Vehicles with automatic transmission:** do not open the driver's door or front passenger

door; the transmission will otherwise automatically shift to position **P**.

- ▶ Install the towing eye (→ page 401).
- ▶ Fasten the towing device.

! **NOTE** Damage due to incorrect connection of the tow bar

- ▶ Only connect the tow rope or tow bar to the towing eyes.

- ▶ Deactivate the automatic locking mechanism (→ page 82).
- ▶ Do not activate the HOLD function.
- ▶ Deactivate the tow-away alarm (→ page 100).
- ▶ Deactivate Active Brake Assist (→ page 260).
- ▶ **Vehicles with automatic transmission:** shift the transmission to position **N**.
- ▶ Release the electric parking brake.

! **WARNING** Risk of accidents due to restricted safety-related functions during towing

Safety-relevant functions will be restricted or no longer available in the following situations:

- The vehicle is switched off.
- The brake system or the power steering is malfunctioning.
- The power supply or the on-board electrical system is defective.

If your vehicle is being towed, considerably more force may be required for steering and braking.

In addition, important vehicle display messages will not be visible if the driver display is faulty.

- ▶ Use a tow bar.
- ▶ Before towing, ensure that the driver's display is operational and the steering can move freely.

! **NOTE** Damage due to excessive tractive power

If you pull away sharply, the tractive power may be too high and the vehicles could be damaged.

- ▶ Pull away slowly and smoothly.

Loading the vehicle for transport

Plug-in hybrid: vehicles should be transported only by professional recovery companies.

- ▶ Observe the notes on towing away (→ page 398).
- ▶ Connect the towing device to the towing eye in order to load the vehicle.
- ▶ Shift the automatic transmission to position **N**.
- ⓘ The automatic transmission may be locked in position **P** in the event of damage to the electrics. To shift to **N**, provide the on-board electrical system with power (→ page 394).
- ▶ Load the vehicle onto the transporter.

- ▶ Shift the automatic transmission to position **P**.
- ▶ Use the electric parking brake to secure the vehicle against rolling away.
- ▶ Secure the vehicle only by the wheels.

4MATIC vehicles/vehicles with automatic transmission

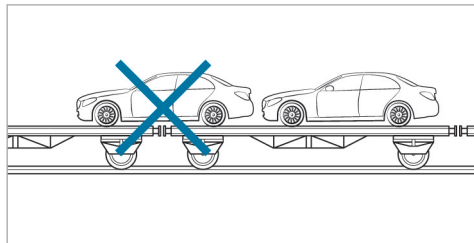

- ▶ Make sure that the front and rear axles come to rest on the same transportation vehicle.

! **NOTE** Damage to the drive train due to incorrect positioning of the vehicle

- ▶ Do not position the vehicle above the connection point of the transport vehicle.

Towing eye storage location

Plug-in hybrid

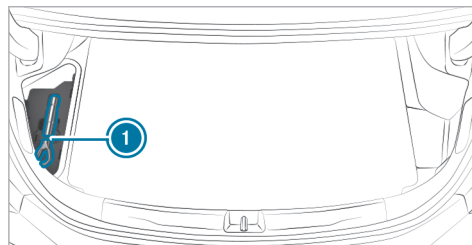

The towing eye **1** is located in a holder in the trunk on the left.

Not plug-in hybrid

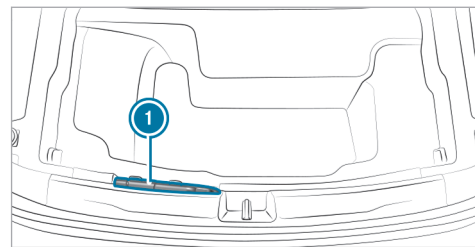

The towing eye **1** is located under the trunk floor in the loading sill.

- i** Depending on the vehicle version, the towing eye is located in a different position in the trunk.

Installing and removing the towing eye

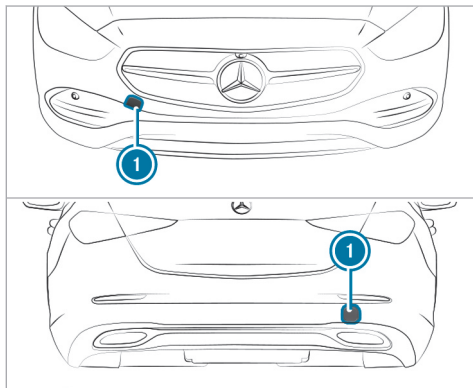

- ▶ Press the cover ① inwards at the marking and remove.

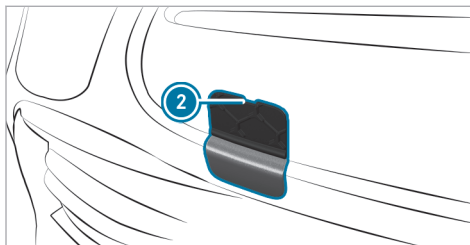

- ▶ **To push out the cover at the recess:** depending on the respective vehicle model, use a suitable tool, e.g. a screwdriver, to pry off the cover at the recess ②.
- ▶ Screw in the towing eye clockwise to the end stop.
- ▶ After removing the towing eye, reattach the cover ① in the bumper.

! **NOTE** Damage to the vehicle due to incorrect use of the towing eye or trailer hitch

When a towing eye or trailer hitch is used to recover a vehicle, the vehicle may be damaged in the process.

- ▶ Only use the towing eye or trailer hitch to tow away or tow start the vehicle.
- ▶ Do not use the towing eye or trailer hitch to tow the vehicle during recovery.

Tow-starting the vehicle

Vehicles with automatic transmission

- ▶ Observe the following note on material damage:

! **NOTE** Damage to the automatic transmission due to tow starting

The automatic transmission may be damaged in the process of tow starting vehicles with automatic transmission.

- ▶ Vehicles with automatic transmission must not be tow started.

Electrical fuses

Notes on electrical fuses

⚠ WARNING Risk of accident and injury due to overloaded lines

If you manipulate or bridge a faulty fuse or if you replace it with a fuse with a higher amperage, the electric line could be overloaded.

This could result in a fire.

- ▶ Always replace faulty fuses with specified new fuses containing the correct amperage.

⚠ NOTE Damage due to incorrect fuses

Using incorrect fuses can result in damage to electrical components or systems or their functions being considerably restricted.

- ▶ Use only fuses approved for Mercedes-Benz with the respective specified fuse rating.

Replace blown fuses with equivalent fuses, identifiable by their color and label. The fuse ratings

and further information to be observed can be found in the fuse assignment diagram.

Fuse assignment diagram: on the fuse box in the trunk (→ page 404).

⚠ NOTE Damage or malfunctions caused by moisture

Moisture may cause damage to the electrical system or cause it to malfunction.

- ▶ When the fuse box is open, make sure that no moisture can enter the fuse box.
- ▶ When closing the fuse box, make sure that the seal of the lid is positioned correctly on the fuse box.

If the newly-inserted fuse also blows, have the cause determined and rectified at a qualified specialist workshop.

Ensure the following before replacing a fuse:

- The vehicle must be secured against rolling away.
- All electrical consumers must be switched off.
- The vehicle must be switched off.

The electrical fuses are located in various fuse boxes:

- Fuse box in the engine compartment on the driver's side (→ page 402)
- Fuse box on the driver's side of the cockpit (→ page 403)
- Fuse box in the front passenger footwell (→ page 404)
- Fuse box in the trunk (→ page 404)

Opening and closing the fuse box in the engine compartment

Requirements

- A dry cloth and a screwdriver are available.

Observe the notes on electrical fuses (→ page 402).

Opening

⚠ WARNING Risk of injury from using the windshield wipers when the hood is open

If the windshield wipers start moving when the hood is open, you could be trapped by the wiper linkage.

▶ Always switch off the windshield wipers and the vehicle first if you need to open the hood.

▶ Open the hood (→ page 364).

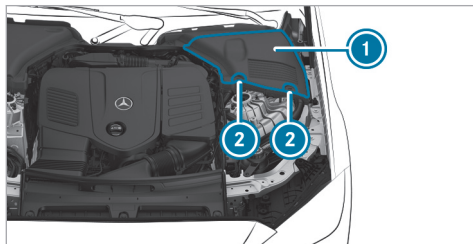

- ▶ Turn both retaining clips ② on cover ① on the driver's side a quarter-turn clockwise.
- ▶ Fold cover ① upwards.

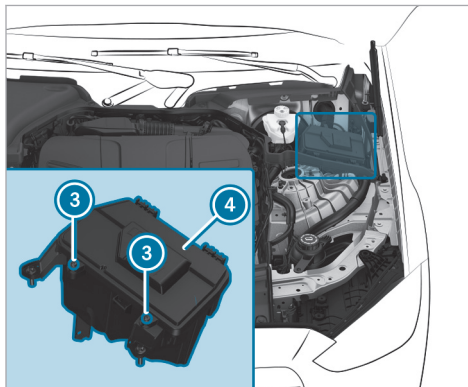

- ▶ Remove any existing moisture from the fuse box using a dry cloth.
- ▶ Loosen screws ③ and remove fuse box lid ④ from the top.

Closing

- ▶ Check whether the seal is positioned correctly in lid ④.
- ▶ Insert lid ④ into the bracket at the rear of the fuse box.
- ▶ Fold down lid ④ of the fuse box and tighten screws ③.
- ▶ Fold down cover ①.
- ▶ Turn both retaining clips ② on cover ① a quarter-turn counter-clockwise.
- ▶ Close the hood.

Opening and closing the fuse box in the cockpit

Requirements

- Observe the notes on electrical fuses (→ page 402).

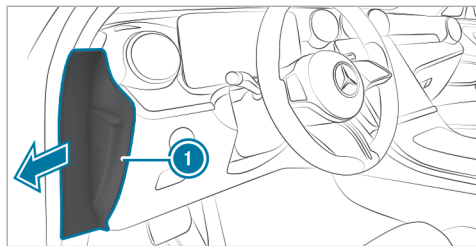

The fuse box is on the driver's side on the side of the cockpit under a cover.

- ▶ **To open:** open cover ① in the direction of the arrow and remove it.
- ▶ **To close:** reinsert cover ①.

Mercedes-Benz recommends you have the fuse box opened at an authorized Mercedes-Benz Center.

Opening and closing the fuse box in the front passenger footwell

Requirements

Observe the notes on electrical fuses (→ page 402).

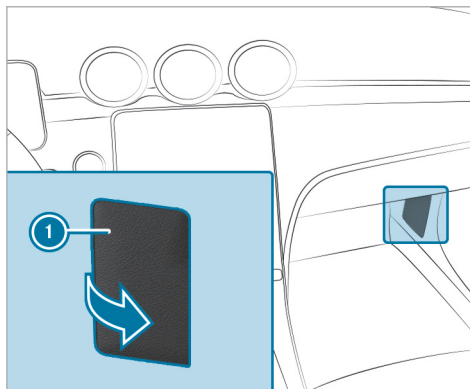

- ▶ **To open:** fold out and remove cover ①.
- ▶ **To close:** reinsert cover ①.

Opening and closing the fuse box in the boot

Requirements

Observe the notes on electrical fuses (→ page 402).

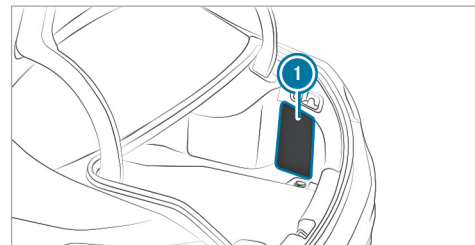

- ▶ **To open:** fold out and remove cover ①.
- ▶ **To close:** reinsert cover ①.

Notes on noise or unusual handling characteristics

Make sure there are no vibrations, noises or unusual handling characteristics when the vehicle is in motion. This may indicate that the wheels or tires are damaged. Hidden tire damage could also be causing the unusual handling characteristics.

If you suspect that a tire is defective, reduce your speed immediately and have the tires and wheels checked at a qualified specialist workshop.

Notes on regularly inspecting wheels and tires

⚠ WARNING Risk of injury through damaged tires

Damaged tires can cause tire pressure loss.

- ▶ Check the tires regularly for signs of damage and replace any damaged tires immediately.

⚠ WARNING Risk of hydroplaning due to insufficient tire tread

Insufficient tire tread will result in reduced tire grip. There is a risk of an accident.

On a wet road surface the risk of hydroplaning is increased, in particular where speed is not adapted to suit the conditions.

- ▶ Check the tread depth and the condition of the tire contact surface across the entire width of all tires on a regular basis.

Minimum tread depth for

- summer tires: $\frac{1}{8}$ in (3 mm)
- M+S tires: $\frac{1}{6}$ in (4 mm)
- ▶ For safety reasons, replace the tires before the legally-prescribed limit for the minimum tread depth is reached.
- ▶ Replace the tires immediately if the legally-prescribed limit for the minimum tread depth is reached.

Carry out the following checks on all wheels regularly, at least once a month or as required, for example, prior to a long journey or driving off-road:

- Check the tire pressure (→ page 406).
- Visually inspect wheels and tires for damage.
- Check the valve caps.
- Visual check of the tire tread depth and the tire contact surface across the entire width.

The minimum tread depth for summer tires is $\frac{1}{8}$ in (3 mm) and for winter tires $\frac{1}{6}$ in (4 mm).

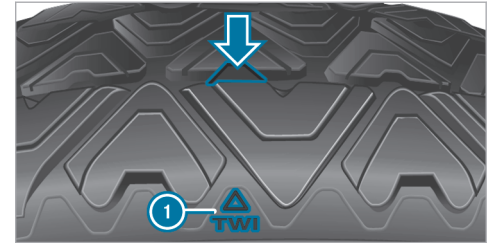

Six marks ① show where the bar indicators (arrow) are integrated into the tire tread. They are

visible once a tire tread depth of approximately $\frac{1}{16}$ in (1.6 mm) has been reached.

Notes on snow chains

⚠ WARNING Risk of accident due to incorrectly installed snow chains

If you have installed snow chains on the front wheels, they may drag against the vehicle body or chassis components.

- ▶ Never install snow chains on the front wheels.
- ▶ Only install snow chains on the rear wheels in pairs.

! NOTE Damage to components of the vehicle body or chassis due to mounted snow chains

If you mount snow chains to the front wheels of 4MATIC vehicles, you may damage components of the vehicle body or chassis.

- ▶ Only mount snow chains to the rear wheels of 4MATIC vehicles.

Observe the following notes when using snow chains:

- Snow chains are only permissible for certain wheel/tire combinations. You can obtain information about this from an authorized Mercedes-Benz Center.
 - For safety reasons, only use snow chains that have been specifically approved for your vehicle by Mercedes-Benz, or snow chains of the same quality standard.
 - Comply with the installation instructions of the snow chain manufacturer.
 - If snow chains are fitted, the maximum permissible speed is 30 mph (50 km/h).
 - **Vehicles with Active Parking Assist:** do not use Active Parking Assist when snow chains are fitted.
- i** You can deactivate ESP® to start off (→ page 233). This allows the wheels to spin, achieving increased tractive power.

Tire pressure

Notes on tire pressure

⚠ WARNING Risk of an accident owing to insufficient or excessive tire pressure

Tires with an insufficient or excessive pressure pose the following dangers:

- The tires can burst.
 - The tires can wear excessively and/or unevenly.
 - The driving characteristics as well as the steering- and braking may be greatly impaired.
- ▶ Observe the recommended tire pressure and check the tire pressure of all tires including the spare wheel:
- monthly
 - when the load changes
 - before embarking on a longer journey

- when the operating conditions change, e.g. off-road driving
 - when driving at over 250 km/h
- ▶ Adjust the tire pressure if necessary.

Too high or too low tire pressure can:

- Shorten the service life of the tires.
- Lead to tire damage.
- Adversely affect driving characteristics and thus driving safety, e.g. due to aquaplaning.

⚠ WARNING Risk of accident due to too low a tire pressure

Tires with pressure that is too low can overheat and burst as a consequence.

In addition, they also suffer from irregular wear, which can significantly impair the braking properties and the handling characteristics.

- ▶ Avoid excessively low tire pressure.

Too low tire pressure can cause:

- Tire defects as a result of overheating
- Impaired handling characteristics
- Irregular wear
- Increased fuel consumption

⚠ WARNING Risk of accident due to too high a tire pressure

Tires with excessively high pressure can burst. In addition, they also suffer from irregular wear, which can significantly impair the braking properties and the handling characteristics.

- ▶ Avoid excessively high tire pressures.

Too high tire pressure can cause:

- Increased braking distance
- Impaired handling characteristics
- Irregular wear
- Impaired driving comfort
- Susceptibility to damage

⚠ WARNING Risk of accident due to repeated pressure drop in the tires

The wheels, valves or tires could be damaged. Too low a tire pressure can lead to the tires bursting.

- ▶ Examine the tires for foreign objects.
- ▶ Check whether the tire has a puncture or the valve has a leak.
- ▶ If you are unable to rectify the damage, contact a qualified specialist workshop.

You can find information on tire pressure for the vehicle's factory-installed tires on the following labels:

- Tire and Loading Information placard on the B-pillar of your vehicle (→ page 413).
- Tire pressure table on the inside of the fuel filler flap (→ page 408).

Also observe the maximum tire pressure (→ page 420).

Use a suitable pressure gauge to check the tire pressure. The outer appearance of a tire does not give any reliable indication of the tire pressure.

Only correct the tire pressure when the tires are cold. Conditions for cold tires:

- The vehicle has been parked with the tires out of direct sunlight for at least three hours.
- The vehicle has travelled less than 1 mile (1.6 km).

The vehicle's tires heat up when driving. As the temperature of a tire increases, so does the tire pressure.

The tire pressure recommended for increased load/speed in the tire pressure table can affect the ride comfort.

⚠ WARNING Risk of accident due to unsuitable accessories on tire valves

If you mount unsuitable accessories onto tire valves, the tire valves may be overloaded and malfunction, which can cause tire pressure loss.

▶ Only screw standard valve caps or valve caps specifically approved by Mercedes-Benz for your vehicle onto the tire valve.

Tire pressure table

The tire pressure table is on the inside of the fuel filler flap.

ⓘ The data shown in the images is example data.

COLD TIRE PRESSURE	
normal load	35.0 psi
maximum load	40.0 psi
Warm tires up to: + 4 psi	

Additional information on the display: A 212 584 00 15, 12M567

The tire pressure table shows the recommended tire pressure for all tires approved for this vehicle. The recommended tire pressures apply for cold

tires under various operating conditions, i.e. vehicle load and/or speed.

If one or more tire sizes precede a tire pressure, the following tire pressure information is only valid for those tire sizes and their respective load condition.

The load conditions "partially laden" and "fully laden" are defined in the table for different numbers of passengers and amounts of luggage. The actual number of seats may differ from this.

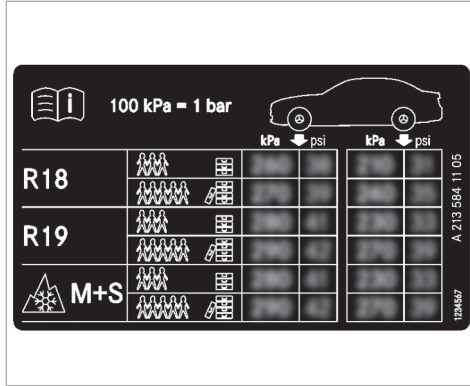

Some tire pressure tables only show the rim diameter instead of the complete tire size, e.g. **R18**. The rim diameter is part of the tire size. The rim diameter can be found on the sidewall of the tire (→ page 420).

- Tire and loading information placard (→ page 413)
- Maximum tire pressure (→ page 420)

Checking the tire pressure manually

- ▶ Read the tire pressure recommended for the current operating conditions from the tire and loading information placard or the tire pressure table. Observe the notes on tire pressure.
- ▶ Remove the valve cap of the tire to be checked.
- ▶ Press the tire pressure gauge securely onto the valve.
- ▶ Read the tire pressure.
- ▶ If the tire pressure is lower than the recommended value, increase the tire pressure to the recommended value.
- ▶ If the tire pressure is higher than the recommended value, release air. To do so, press down the metal pin in the valve, e.g. using the tip of a pen. Then check the tire pressure again using the tire pressure gauge.
- ▶ Screw the valve cap onto the valve.

Further related subjects:

- Notes on tire pressure (→ page 406)
- Tire pressure table (→ page 408)

- Tire and loading information placard (→ page 413)

Tire pressure monitoring system

Function of the tire pressure monitoring system

⚠ DANGER Risk of accident due to incorrect tire pressure

Each tire, including the spare (if provided), should be checked monthly when cold and inflated to the inflation pressure recommended by the vehicle manufacturer on the vehicle placard or tire inflation pressure label. (If your vehicle has tires of a different size than the size indicated on the vehicle placard or tire inflation pressure label, you should determine the proper tire inflation pressure for those tires.)

As an added safety feature, your vehicle has been equipped with a tire pressure monitoring system (TPMS) that illuminates a low tire pressure telltale when one or more of your tires is significantly under-inflated. Accordingly, when

the low tire pressure telltale illuminates, you should stop and check your tires as soon as possible, and inflate them to the proper pressure. Driving on a significantly under-inflated tire causes the tire to overheat and can lead to tire failure. Under-inflation also reduces fuel efficiency and tire tread life, and may affect the vehicle's handling and stopping ability. Please note that the TPMS is not a substitute for proper tire maintenance, and it is the driver's responsibility to maintain correct tire pressure, even if under-inflation has not reached the level to trigger illumination of the TPMS low tire pressure telltale.

Your vehicle has also been equipped with a TPMS malfunction indicator to indicate when the system is not operating properly. The TPMS malfunction indicator is combined with the low tire pressure telltale. When the system detects a malfunction, the telltale will flash for approximately one minute and then remain continuously illuminated. This sequence will continue upon subsequent vehicle start-ups as long as the malfunction exists.

When the malfunction indicator is illuminated, the system may not be able to detect or signal low tire pressure as intended. TPMS malfunctions may occur for a variety of reasons, including the installation of replacement or alternate tires or wheels on the vehicle that prevent the TPMS from functioning properly.

The system checks the tire pressure and the temperature of the tires installed on the vehicle by means of a tire pressure sensor.

The tire pressure and the tire temperature are displayed on the driver display.

In the event of significant pressure loss or excessive temperature of the tires, you will be warned by display messages (→ page 517) or the warning light  on the driver display (→ page 543).

The tire pressure monitoring system serves solely as an aid. It is the driver's responsibility to set the tire pressure to the recommended cold tire pressure suitable for the operating situation.

In most cases, the tire pressure monitoring system will automatically update the new reference

values after you have changed the tire pressure. You can, however, also update the reference values by restarting the tire pressure monitoring system manually (→ page 411).

System limits

The system may be impaired or inoperative in the following situations in particular:

- Incorrect reference values were taught in.
- Sudden pressure loss caused, e.g. by a foreign object penetrating the tire.
- There is a malfunction caused by another radio signal source.

■ Checking the tire pressure with the tire pressure monitoring system

Requirements:

- The vehicle is switched on.

Driver display:

  **Service**

 Press  to confirm.

One of the following messages will appear:

- Current tire pressure on each wheel:



- **Tire pressure displayed after driving for a few minutes.:** Current values are not yet known to the system. The pressure/temperature values of each tire will be displayed as soon as they are known to the system.
 - **Tire Pressure Monitor Active:** The teach-in process of the system is not yet complete. The tire pressures are already being monitored.
- ▶ Compare the current tire pressure with the recommended tire pressure for the current

operating status (→ page 408). Additionally, observe the notes on cold tires (→ page 406).

- ⓘ The values shown on the driver display may differ from those of the tire pressure gauge because they relate to sea level. At high elevations, the tire pressure values indicated by a pressure gauge will be higher than those shown on the driver display.

Bear in mind the following related topic:

- Notes on tire pressure (→ page 406)

Restarting the tire pressure monitoring system

Requirements

- The recommended tire pressure is correctly set for the respective operating condition at each of the four wheels (→ page 406).

Restart the tire pressure monitoring system in the following situations:

- The tire pressure has changed.
- The wheels or tires have been changed or newly installed.

Driver display:

▶ ▶ Service

- ▶ Show tire pressure: press .
- ▶ Show options: press again.
- ▶ Select **Tire Pressure** and confirm with . The **Use current pressures as new reference values?** message will appear on the driver display.
- ▶ Select **Yes** and confirm the restart with . The **Tire Pressure Monitor Restarted** message will appear on the driver display.

Current warning messages will be deleted and the yellow warning lamp will go out.

After you have driven for a few minutes, the system will check whether the current tire pressures are within the specified range. The current tire pressures will then be accepted as reference values and monitored.

If the tire pressure levels are not within the specified range, the **Please Correct Tire Pressure** message will appear.

Bear in mind the following related topic:

- Notes on tire pressure (→ page 406)

Tire pressure loss warning system

■ Function of the tire pressure loss warning system

The tire pressure loss warning system warns the driver by means of display messages when there is a severe tire pressure loss.

System limits

The system may be impaired or may not function particularly in the following situations:

- incorrect reference values were taught in
- sudden pressure loss caused by a foreign object penetrating the tire, for example
- an even pressure loss on more than one tire occurs

The system has a restricted or delayed function particularly in the following situations:

- poor ground conditions, e.g. snow or gravel

- driving with snow chains
- when adopting a very sporty driving style with high cornering speeds or sudden acceleration
- driving with a high load

The tire pressure loss warning system is only an aid. It is the driver's responsibility to set the tire pressure to the recommended cold tire pressure suitable for the operating situation and to check it.

Be sure to also observe the following further related subjects:

- Notes on tire pressure (→ page 406)
- Display messages about the tires (→ page 517)

■ Restarting the tire pressure loss warning system

Requirements

- The recommended tire pressure is correctly set for the respective operating condition on each of the four wheels (→ page 406).

Restart the tire pressure loss warning system in the following situations:

- The tire pressure has changed.
- The wheels or tires have been changed or newly installed.

Driver display:

→  **Service**

- ▶ Select **Tire Pressure** and confirm with **OK**. The driver display shows a message reading **Run Flat Indicator Active**.
- ▶ To initiate the restart: press the steering wheel button **OK**. The driver display shows a message reading **Are the current pressure values OK?**
- ▶ Select **Yes**.
- ▶ To confirm the restart: press the steering wheel button **OK**. The driver display shows a message reading **Run Flat Indicator Restarted**.

Be sure to observe the following further related topics:

- Notes on tire pressure (→ page 406)

Loading the vehicle

Notes on the Tire and Loading Information placard

⚠ WARNING Risk of accident from overloaded tires

Overloaded tires may overheat and burst as a consequence. Overloaded tires can also impair the steering and handling characteristics and lead to brake failure.

- ▶ Observe the load rating of the tires.
- ▶ The load rating must be at least half the permissible axle load of the vehicle.
- ▶ Never overload the tires by exceeding the maximum load.

The Tire and Loading Information placard is on the B-pillar on the driver's side of the vehicle.

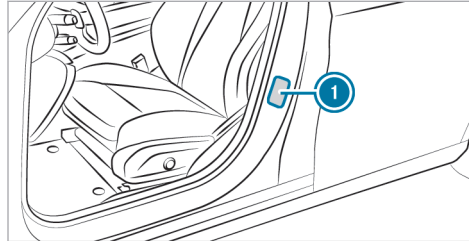

① Tire and Loading Information placard

TIRE AN RENSEIGNEMENTS		LOADING INFORMATION		INFORMATION LE CHARGEMENT	
SEATING CAPACITY NOMBRE DE PLACES	TOTAL: 7	FRONT AVANT	2	MIDDLE EU	3
The combined weight of occupants and cargo should never exceed Le poids total des occupants et du chargement ne doit jamais dépasser		XXXX kg or XXXX lbs.*			
TIRE PNEU	SIZE DIMENSIONS	COLD TIRE PRESSURE PRESSION DES PNEUS À FROID		SEE OWNER'S MANUAL FOR ADDITIONAL INFORMATION	
FRONT AVANT	285/40 ZR18 90Y XL	200 KPA, 29 PSI		VOIR LE MANUEL DE L'USAGER POUR PLUS DE RENSEIGNEMENTS	
REAR ARRIÈRE	285/35 ZR18 101Y XL	200 KPA, 29 PSI			
Spare DE SECOURS	175/55-18 95P	420 KPA, 60 PSI			

① The data shown in the illustration are sample data.

The Tire and Loading Information placard shows the following information:

- Maximum number of seats ② according to the maximum number of people permitted to travel in the vehicle.

414 Wheels and tires

- Maximum permissible load ③ comprises the gross weight of all vehicle occupants, luggage and additional load.
- Recommended tire pressure ① for cold tires. The recommended tire pressures are valid for the maximum permissible load and up to the maximum permissible vehicle speed.

Please also note:

- Information on permissible weights and loads on the vehicle identification plate (→ page 439).
- Information on the tire pressure in the tire pressure table (→ page 408).

Further related subjects:

- Determining the maximum permissible load (→ page 414).
- Notes on the tire pressure (→ page 406).

Steps for determining the correct load limit

The following steps were developed according to the regulations of Title 49, Code of U.S. Federal

Regulations, Part 575, which are binding on all manufacturers, and the National Traffic and Motor Vehicle Safety Act of 1966.

- ▶ (1): Locate the statement "The combined weight of occupants and cargo should never exceed XXX kg or XXX lbs." on your vehicle's placard.
- ▶ (2): Determine the combined weight of the driver and passengers that will be riding in your vehicle.
- ▶ (3): Subtract the combined weight of the driver and passengers from XXX kg or XXX lbs.
- ▶ (4): The resulting figure equals the available amount of cargo and luggage load capacity. For example, if the "XXX" amount equals 1400 lbs. and there will be five 150 lb passengers in your vehicle, the amount of available cargo and luggage load capacity is 650 lbs. (1400 - 750 (5 x 150) = 650 lbs.)
- ▶ (5): Determine the combined weight of luggage and cargo being loaded on the vehicle. That weight may not safely exceed the available cargo and luggage load capacity calculated in Step 4.

- ▶ (6): If your vehicle will be towing a trailer, load from your trailer will be transferred to your vehicle. Consult this manual to determine how this reduces the available cargo and luggage load capacity of your vehicle.

- ① Not all vehicles are permitted to tow a trailer. Towing a trailer is only permitted if a trailer-hitch is installed. Please consult an authorized Mercedes-Benz dealer if you have any questions about towing a trailer with your vehicle.

Even if you have calculated the total load carefully, you should still make sure that the maximum permissible gross weight and the maximum gross axle weight rating of your vehicle are not exceeded. Details can be found on the vehicle identification plate.

- ▶ Have your loaded vehicle – including driver, occupants and load – weighed on a vehicle weighbridge. The measured values may not exceed the maximum permissible values stated on the vehicle identification plate.

Further related subjects:

- Calculation example for determining the maximum load (→ page 415)
- Tire and loading information placard (→ page 413)
- Tire pressure table(→ page 408)
- Vehicle identification plate (→ page 439)

Calculation example for determining the maximum payload

The following table shows examples of how to calculate total load capacities and payloads with varying seating configurations and different occupant numbers and weights. The following examples use a maximum payload of 1500 lbs

(680 kg). **This is for illustration purposes only.** Make sure you are using the actual maximum payload for your vehicle as stated in the Tire and Loading Information table of your vehicle (→ page 413).

The higher the weight of all the occupants, the lower the maximum luggage load.

Step 1

	Example 1	Example 2
Combined maximum weight of occupants and payload (data from the Tire and Loading Information table)	1500 lbs (680 kg)	1500 lbs (680 kg)

Step 2

	Example 1	Example 2
Number of persons in the vehicle (driver and passengers)	5	1
Distribution of vehicle occupants	Front: 2 Rear: 3	Front: 1
Weight of vehicle occupants	Occupant 1: 150 lbs (68 kg) Occupant 2: 180 lbs (82 kg) Occupant 3: 160 lbs (73 kg) Occupant 4: 140 lbs (63 kg) Occupant 5: 120 lbs (54 kg)	Occupant 1: 200 lbs (91 kg)
Total weight of all vehicle occupants	750 lbs (340 kg)	200 lbs (91 kg)

Step 3

	Example 1	Example 2
Permissible payload (maximum permissible gross vehicle weight from the Tire and Loading Information table minus the total weight of all occupants)	1500 lbs (680 kg) - 750 lbs (340 kg) = 750 lbs (340 kg)	1500 lbs (680 kg) - 200 lbs (91 kg) = 1300 lbs (589 kg)

Tire labeling

Overview of tire labeling

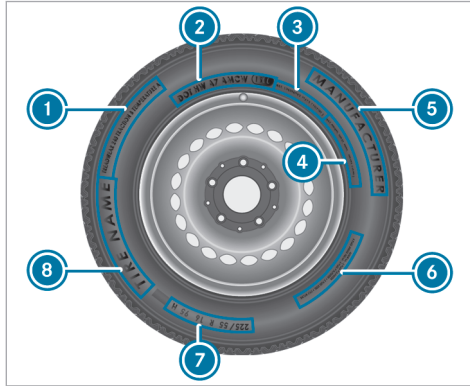

- ① Uniform Tire Quality Grading Standards
- ② DOT (Department of Transportation), (TIN) Tire Identification Number
- ③ Maximum tire load (→ page 419)
- ④ Maximum tire pressure (→ page 420)

- ⑤ Manufacturer
- ⑥ Tire characteristics (→ page 420)
- ⑦ Tire size designation, load-bearing capacity, speed rating and load index (→ page 420)
- ⑧ Tire name
- ⑨ The data shown in the illustration is example data.

Tire quality grading

In accordance with the US Department of Transportation's "Uniform Tire Quality Grading Standards," tire manufacturers are required to grade their tires on the basis of the following three performance factors:

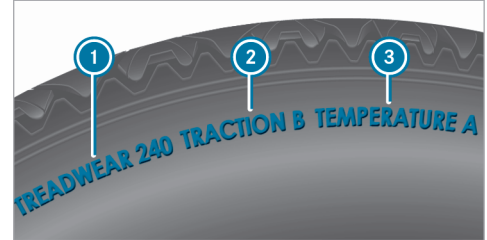

- ① Tread wear grade
- ② Traction grade
- ③ Temperature grade
- ⑨ The data shown in the illustration is example data.
- ⑨ The classification is not legally stipulated for Canada, but it is generally stated.

Tread wear grade

The tread wear grade is a comparative rating based on the wear rate of the tire when tested under controlled conditions on a specified government test course. For example, a tire graded 150 would wear one and one-half (1\1/2\) times as

well on the government course as a tire graded 100.

The relative performance of tires depends upon the actual conditions of their use, however, and may depart significantly from the norm due to variations in driving habits, service practices and differences in road characteristics and climate.

Traction grade

⚠ DANGER Risk of accident due to inadequate traction

The traction grade assigned to this tire is based on straight-ahead braking traction tests.

- ▶ Always adapt your driving style and drive at a speed to suit the prevailing traffic and weather conditions.

! NOTE Damage to the drivetrain from wheelspin

- ▶ Avoid wheelspin.

The traction grades, from highest to lowest, are AA, A, B, and C. Those grades represent the tire's ability to stop on wet pavement as measured under controlled conditions on specified government test surfaces of asphalt and concrete. A tire marked C may have poor traction performance.

Temperature grade

⚠ WARNING Risk of accident from tire overheating and tire failure

Excessive speed, underinflation, or excessive loading, either separately or in combination, can cause excessive heat build-up and possible tire failure.

- ▶ Observe the recommended tire pressure.
- ▶ Regularly check the pressure of all the tires.
- ▶ Adjust the tire pressure, if necessary.

The temperature grades are A (the highest), B, and C, representing the tire's resistance to the generation of heat and its ability to dissipate heat when tested under controlled conditions on a specified indoor laboratory test wheel. Sustained

high temperature can cause the material of the tire to degenerate and reduce tire life, and excessive temperature can lead to sudden tire failure. The grade C corresponds to a level of performance which all passenger car tires must meet under the Federal Motor Safety Standard No. 109. Grades B and A represent higher levels of performance on the laboratory test wheel than the minimum required by law.

DOT, Tire Identification Number (TIN)

US tire regulations stipulate that every tire manufacturer or retreader must imprint a TIN in or on the side wall of each tire produced.



① The data in the illustration is shown as an example.

The TIN is a unique identification number to identify tires, and comprises the following:

- **DOT (Department of Transportation):** tire marking ① indicating that the tire complies with the requirements of the US Department of Transportation.
- **Manufacturer identification code:** the manufacturer identification code ② contains details of the tire manufacturer. New tires have a code with two symbols. Retreaded tires have a code with four symbols. Further information on retreaded tires (→ page 425).
- **Tire size:** the marking ③ states the tire size.
- **Tire type code:** the tire type code ④ can be used by the manufacturer as a code to describe specific characteristics of the tire.
- **Manufacturing date:** the manufacturing date ⑤ provides information about the age of a tire. The 1st and 2nd digits represent the calendar week and the 3rd and 4th digits state

the year of manufacture (e.g. "3208" represents the 32nd week of 2008).

Information on the maximum tire load

⚠ WARNING Risk of accident from overloaded tires

Overloaded tires may overheat and burst as a consequence. Overloaded tires can also impair the steering and handling characteristics and lead to brake failure.

- ▶ Observe the load rating of the tires.
- ▶ The load rating must be at least half the permissible axle load of the vehicle.
- ▶ Never overload the tires by exceeding the maximum load.



① The data in the illustration is shown as an example.

Maximum tire load ① is the maximum permissible weight for which the tire is approved.

Do not overload the tires by exceeding the maximum permissible load limit. The maximum permissible load can be found on the vehicle's Tire and Loading Information table on the B-pillar on the driver's side (→ page 413).

Information on maximum tire pressure



i The data in the illustration is shown as an example.

Do not exceed the maximum tire pressure **1** permitted for the tire. Always observe the recommended tire pressure for your vehicle when adjusting the tire pressure (→ page 408).

Information on tire composition



i The data in the illustration is shown as an example.

It describes the type of tire cord and the number of layers in the side wall **1** and under the tire tread **2**.

Tire size, load-bearing capacity, speed rating and load index

⚠ WARNING Risk of injury through exceeding the specified tire load-bearing capacity or the permissible speed rating

Exceeding the specified tire load rating or the permissible speed rating may lead to tire damage and to the tires bursting.

- ▶ Therefore, only use tire types and sizes approved for your vehicle model.
- ▶ Observe the tire load rating and speed rating required for your vehicle.

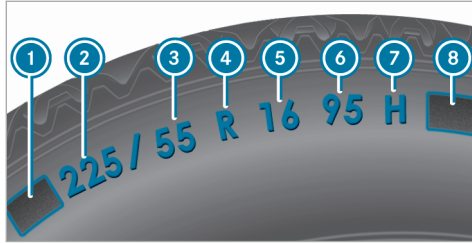

- ① Preceding letter
- ② Nominal tire width in millimeters
- ③ Aspect ratio in %
- ④ Tire code
- ⑤ Rim diameter
- ⑥ Load-bearing index
- ⑦ Speed rating
- ⑧ Load index

i The data in the illustration is shown as an example.

Information about interpreting tire data can be obtained from any qualified specialist workshop.

Preceding letter ①:

- None: passenger car tires according to European manufacturing standards.
- "P": passenger car tires according to US manufacturing standards.
- "LT": light truck tires according to US manufacturing standards.
- "T": compact emergency spare wheels with high tire pressure that are only designed for temporary use in an emergency.

Aspect ratio ③:

Ratio between tire height and tire width in percent (tire height divided by tire width).

Tire code ④ (tire type):

- "R" radial tire
- "D": bias ply tire
- "B": bias radial tire
- "ZR": radial tire with a maximum permissible speed above 149 mph (240 km/h) (optional)

Rim diameter ⑤:

The diameter of the bead seat (not the diameter of the rim flange). The rim diameter is specified in inches (in).

Load-bearing index ⑥:

Numerical code that specifies the maximum load-bearing capacity of a tire (e.g. "91" corresponds to 1356 lbs (615 kg)).

The load-bearing capacity of the tire must be at least half the gross axle weight rating of your vehicle. Do not overload the tires by exceeding the maximum permissible payload.

See also:

- Maximum permissible payload in the Tire and Loading Information table (→ page 413)
- Maximum tire load (→ page 419)
- Load index

Speed rating ⑦:

Specifies the maximum permissible speed of the tire.

422 Wheels and tires

- i** An electronic speed limiter prevents your vehicle from exceeding a speed of 130 mph (210 km/h).

Make sure that your tires have the required speed rating. You can obtain information on the required speed rating from a Mercedes-Benz service center.

Summer tires

Index	Speed rating
Q	up to 100 mph (160 km/h)
R	up to 106 mph (170 km/h)
S	up to 112 mph (180 km/h)
T	up to 118 mph (190 km/h)
H	up to 130 mph (210 km/h)
V	up to 149 mph (240 km/h)
W	up to 168 mph (270 km/h)

¹ "ZR" stated in the tire code.

² Or "M+S"  for winter tires.

Index	Speed rating
Y	up to 186 mph (300 km/h)
ZR...Y ¹	up to 186 mph (300 km/h)
ZR... (..Y) ¹	over 186 mph (300 km/h)
ZR ¹	over 149 mph (240 km/h)

- Specifying the speed rating as the "ZR" index in the tire code **4** is optional for tires up to 186 mph (300 km/h).
- If your tire code **4** includes "ZR" and there is no speed rating **7**, find out the maximum permissible speed from the tire manufacturer.
- If the load-bearing index **6** and speed rating **7** are in brackets, the maximum permissible speed of your tire is above 186 mph (300 km/h). To find out the maximum permissible speed, ask the tire manufacturer.

All-weather tires and winter tires

Index	Speed rating
Q M+S ²	up to 100 mph (160 km/h)
T M+S ²	up to 118 mph (190 km/h)
H M+S ²	up to 130 mph (210 km/h)
V M+S ²	up to 149 mph (240 km/h)

Winter tires bear the snowflake symbol  and fulfill the requirements of the Rubber Manufacturers Association (RMA) and the Rubber Association of Canada (RAC) regarding the tire traction on snow.

Load index **8**:

- No specification given: standard load (SL) tire
- "XL" or "Extra Load": extra load tire or reinforced tire
- "Light Load": light load tire

- "C", "D", "E": a load range that depends on the maximum load the tire can carry at a certain pressure.

Definition of terms for tires and loading

Tire structure and characteristics: describes the number of layers or the number of rubber-coated belts in the tire contact surface and the tire wall. These are made of steel, nylon, polyester and other materials.

Bar: metric unit for tire pressure. 14.5038 pounds per square inch (psi) and 100 kilopascal (kPa) is the equivalent of one bar.

DOT (Department of Transportation): DOT-marked tires fulfill the requirements of the US Department of Transportation.

Average weight of the vehicle occupants: the number of vehicle occupants for which the vehicle is designed, multiplied by 150 lb (68 kg).

Uniform tire quality grading standards: a uniform standard to grade the quality of tires with regard to tread quality, tire traction and temperature characteristics. The quality grading assessment is

made by the manufacturer following specifications from the U.S. government. The quality grade of a tire is imprinted on the side wall of the tire.

Recommended tire pressure: the recommended tire pressure is the tire pressure specified for the tires fitted to the vehicle at the factory.

The tire and load information table contains the recommended tire pressure for cold tires, the maximum permissible load and the maximum permissible vehicle speed.

The tire pressure table contains the recommended tire pressure for cold tires under various operating conditions, i.e. loading and/or speed of the vehicle.

Increased vehicle weight due to optional equipment: the combined weight of all standard and optional equipment available for the vehicle, regardless of whether it is actually installed on the vehicle or not.

Rim: the part of the wheel on which the tire is mounted.

GAWR (Gross Axle Weight Rating): the GAWR is the maximum gross axle weight rating. The actual load on an axle must never exceed the gross axle

weight rating. The gross axle weight rating can be found on the vehicle identification plate on the B-pillar on the driver's side.

Speed rating: the speed rating is part of the tire identification. It specifies the speed range for which a tire is approved.

GVW (Gross Vehicle Weight): the gross vehicle weight comprises the weight of the vehicle including fuel, tools, spare wheel, fitted accessories, occupants, luggage and the trailer tongue weight, if applicable. The gross vehicle weight must not exceed the gross vehicle weight rating GVWR as specified on the vehicle identification plate on the B-pillar on the driver's side.

GVWR (Gross Vehicle Weight Rating): the GVWR is the maximum permitted gross weight of the fully laden vehicle (weight of the vehicle including all accessories, occupants, fuel, luggage and the trailer tongue weight if applicable). The gross vehicle weight rating is specified on the vehicle identification plate on the B-pillar on the driver's side.

Maximum weight of the laden vehicle: the maximum weight is the sum of the unladen weight of the vehicle, the weight of the accessories, the

maximum load and the weight of optional equipment installed at the factory.

Kilopascal (kPa): metric unit for tire pressure. 6.9 kPa corresponds to 1 psi. Another unit for tire pressure is bar. 100 kilopascal (kPa) equals 1 bar.

Load index: in addition to the load-bearing index, the load index may also be imprinted on the side wall of the tire. This specifies the load-bearing capacity of the tire more precisely.

Unladen weight: the weight of a vehicle with standard equipment including the maximum capacity of fuel, service fluids and coolant. It also includes the air conditioning system and optional equipment if these are installed in the vehicle, but does not include passengers or luggage.

Maximum tire load: the maximum tire load is the maximum permissible weight in kilograms or lbs for which a tire is approved.

Maximum permissible tire pressure: maximum permissible tire pressure for one tire.

Maximum load on one tire: maximum load per tire. This is calculated by dividing the maximum axle load of one axle by two.

PSI (pounds per square inch): standard unit of measurement for tire pressure.

Aspect ratio: ratio between tire height and tire width in percent.

Tire pressure: pressure inside the tire applying an outward force to every square inch of the tire. The tire pressure is specified in pounds per square inch (psi), in kilopascals (kPa) or in bar. The tire pressure should only be corrected when the tires are cold.

Cold tire pressure: the tires are cold when the vehicle has been parked for at least 3 hours without direct sunlight on the tires, or the vehicle has been driven for less than 1 mile (1.6 km).

Tire contact surface: the part of the tire that comes into contact with the road.

Tire bead: the purpose of the tire bead is to ensure that the tire sits securely on the wheel rim. There are several wire cores in the tire bead to prevent the tire from changing length on the wheel rim.

Side wall: the part of the tire between the tread and the tire bead.

Weight of optional equipment: the combined weight of the optional equipment weighing more than the replaced standard parts and more than 5 lbs (2.3 kg). This optional equipment, such as high-performance brakes, level control system, a roof luggage rack or high-performance batteries, is not included in the unladen weight and the weight of the accessories.

TIN (Tire Identification Number): a unique identification number which can be used by a tire manufacturer to identify tires, for example in a product recall, and thus identify the purchasers. The TIN is made up of the manufacturer's identity code, tire size, tire type code and the manufacturing date.

Load-bearing index: the load-bearing index is a code that contains the maximum load-bearing capacity of a tire.

Traction: traction is the grip resulting from friction between the tire and the road surface.

Wear indicator: narrow bars (tread wear bars) that are distributed over the tire contact surface. If the tire tread is level with the bars, the wear limit of 1/16 in (1.6 mm) has been reached.

Distribution of vehicle occupants: distribution of vehicle occupants over designated seat positions in a vehicle.

Maximum permissible payload weight: nominal load and luggage load plus 150 lb (68 kg) multiplied by the number of seats in the vehicle.

Changing a wheel

Notes on selecting, installing and replacing tires

! **NOTE** Mercedes-AMG vehicles

▶ Observe the notes in the Supplement. You could otherwise fail to recognize dangers.

⚠ **WARNING** Risk of accident due to incorrect wheel and tire dimensions

If wheels and tires of the wrong size are installed, the service brakes or components in the brake system and in the wheel suspension may be damaged.

▶ Always replace wheels and tires with ones that fulfill the specifications of the original part.

For wheels, pay attention to the following:

- Designation
- Type

For tires, pay attention to the following:

- Designation
- Manufacturer
- Type

⚠ **WARNING** Risk of injury through exceeding the specified tire load-bearing capacity or the permissible speed rating

Exceeding the specified tire load rating or the permissible speed rating may lead to tire damage and to the tires bursting.

- ▶ Therefore, only use tire types and sizes approved for your vehicle model.
- ▶ Observe the tire load rating and speed rating required for your vehicle.

! **NOTE** Vehicle and tire damage caused by non-approved tire types and sizes

For safety reasons, only use tires, wheels and accessories which have been specially approved by Mercedes-Benz for your vehicle.

These tires are specially adapted to the active safety systems, such as ABS, ESP® and 4MATIC, and marked as follows:

- MO = Mercedes-Benz Original
- MOE = Mercedes-Benz Original Extended (tires with run-flat characteristics for certain wheels only)
- MO1 = Mercedes-Benz Original (only certain AMG tires)

Otherwise, certain properties, such as driving characteristics, vehicle noise emissions, consumption, etc. could be adversely affected. Furthermore, other tire sizes could result in the tires rubbing against the body and axle components when loaded. This could result in damage to the tire or the vehicle.

Only use tires, wheels and accessories that have been checked and recommended by Mercedes-Benz.

! **NOTE** Risk to driving safety from retreaded tires

Retreaded tires are neither tested nor recommended by Mercedes-Benz, since previous damage cannot always be detected on retreaded tires.

For this reason driving safety cannot be guaranteed.

- ▶ Do not use used tires if you have no information about their previous usage.

! **NOTE** Possible wheel and tire damage when driving over obstacles

Large wheels have a smaller section width. As the section width decreases, the risk of wheels and tires being damaged when driving over obstacles increases.

- ▶ Avoid obstacles or drive especially carefully.
- ▶ Reduce your speed when driving over curbs, speed bumps, manhole covers and potholes.
- ▶ Avoid particularly high curbs.

! **NOTE** Possible wheel and tire damage when parking on curbs or in potholes

Parking on curbs or in potholes can damage the wheels and tires.

- ▶ Only park on as level a surface as possible.
- ▶ Avoid curbs and potholes when parking.

! **NOTE** Damage to electronic components due to the use of mounting tools

Vehicles with a tire pressure monitoring system: there are electronic components in the wheel.

Using mounting tools in the area of the valve may damage the electronic components.

- ▶ Tire mounting tools should not be used in the area of the valve.
- ▶ Always have tires changed at a qualified specialist workshop.

! **NOTE** Damage to summer tires at low ambient temperatures

At low ambient temperatures, tears could form when driving with summer tires, causing permanent damage to the tires.

- ▶ At temperatures below 45 °F (7 °C) use  M+S tires.

Accessory parts which are not approved for your vehicle by Mercedes-Benz, or which are not used correctly, can impair the operating safety.

Before purchasing and using non-approved accessories, visit a qualified specialist workshop and inquire about:

- Suitability
- Legal stipulations
- Factory recommendations

⚠ WARNING Risk of accidents with sports tires

The special tire tread in combination with the optimized tire compound means that the risk of skidding or hydroplaning on wet roads is increased.

In addition, the tire grip is greatly reduced at a low outside temperature and tire running temperature.

- ▶ Switch on ESP® and adapt your driving style accordingly.
- ▶ Use  M+S tires at outside temperatures of less than 45°F (7°C).
- ▶ Only use tires suitable for the intended use.

Observe the following when selecting, installing and replacing tires:

- The use of certain tire types in certain regions and areas of operation can be advisable.
- Only use tires and wheels of the same type (summer tires, winter tires, MOExtended tires) and the same make.

- Only install wheels of the same size on one axle (left and right).
Only deviate from this in the event of a flat tire, to enable you to drive to a specialist workshop.
- **Vehicles with a tire pressure monitoring system:** all installed wheels must be equipped with functioning sensors for the tire pressure monitoring system.
- At temperatures below 45 °F (7 °C), use winter tires or all-season tire marked  M+S for all wheels.
Winter tires provide the best possible grip in wintry road conditions.
- When fitting M+S tires, only use tires with the same tread.
- Observe the maximum permissible speed for the M+S tires installed.
If the tire's maximum speed is below that of the vehicle, this must be indicated by an appropriate label in the driver's field of vision.
- Run-in new tires at moderate speeds for the first 60 miles (100 km).

- Replace the tires after six years at the latest, regardless of wear.
- **When replacing with tires that do not feature run-flat characteristics:** vehicles with MOExtended tires are not equipped with a TIREFIT kit at the factory. Equip the vehicle with a TIREFIT kit after fitting tires that do not feature run-flat characteristics, e.g. winter tires.

For more information on wheels and tires, contact a qualified specialist workshop.

Be sure to also observe the following further related topics:

- Notes on tire pressure (→ page 406)
- Tire and Loading Information table (→ page 413)
- Tire size, load-bearing capacity, speed rating and load index (→ page 420)
- Tire pressure table (→ page 408)
- Notes on the emergency spare wheel (→ page 435)

Notes on rotating wheels

⚠ WARNING Risk of injury through different wheel sizes

Rotating the front and rear wheels can severely impair the driving characteristics.

The wheel brakes or suspension components may also be damaged.

▶ Rotate front and rear wheels only if the wheels and tires are of the same dimensions.

Observe the instructions and safety notes on "Changing a wheel" (→ page 425).

The front and rear wheels are subject to different wear:

- Front wheels wear more on the tire shoulder
- Rear wheels wear more in the center of the tire

Do not drive with tires that have too little tread depth. This significantly reduces traction on wet roads (hydroplaning).

On vehicles that have the same size front and rear wheels, rotate the wheels according to the intervals in the tire manufacturer's warranty booklet in your vehicle documents. If this is not available, rotate the tires every 3,000 to 6,000 miles (5,000 to 10,000 km), depending on wear. Do not change the direction of wheel rotation.

Notes on storing wheels

When storing wheels, observe the following notes:

- After removing wheels, store them in a cool, dry and preferably dark place.
- Protect the tires from contact with oil, grease or fuel.

Overview of the tire-change tool kit

! **NOTE** Mercedes-AMG vehicles

▶ Observe the notes in the Supplement. You could otherwise fail to recognize dangers.

With the exception of some country-specific variants, vehicles are not equipped with tire-change tool kits. Consult a qualified specialist workshop to find out which tire-change tool kit is necessary and approved for a wheel change on your vehicle.

You require the following tools, for example, to change a wheel:

- Jack
- Chock
- Lug wrench
- Alignment bolt

The tire-change tool kit is located in tool bag  in the trunk.

 When stowing the tool bag, ensure that it is adequately secured.

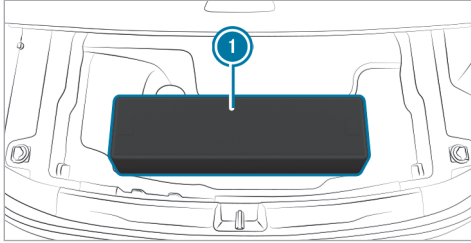

The tool bag contains:

- Jack
- Gloves
- Lug wrench
- Alignment bolt
- Folding chock
- Ratchet wrench for jack

Overview of the plug-in hybrid tire-change tool kit

The tire-change tool kit is located in the tool bag **1** in the trunk floor.

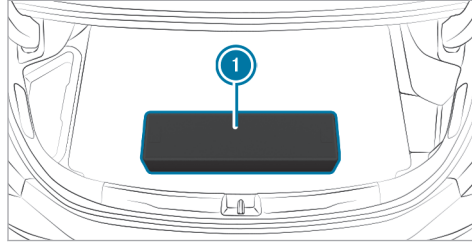

Preparing the vehicle for a wheel change

Requirements:

- The vehicle is not on a slope.
 - The vehicle is on solid, non-slippery and level ground.
 - The required tire-change tool kit is available.
- i** If your vehicle is not equipped with the tire-change tool kit, consult a qualified specialist workshop to find out about suitable tools.
- ▶** Apply the electric parking brake manually.

- ▶** Move the front wheels to the straight-ahead position.
- ▶** Shift the transmission to position **P**.
- ▶** Switch off the vehicle.
- ▶** Make sure that the vehicle cannot be started.
- ▶** Place chocks or other suitable items under the front and rear of the wheel that is diagonally opposite the wheel you wish to change.
- ▶** Unload the vehicle.

Removing and installing wheel trim/hub caps

Requirements

- The vehicle is prepared for a wheel change (→ page 429).

Plastic hub cap

Removing:

- ▶** Turn the center cover of the hub cap counter-clockwise and remove the hub cap.

Installing:

- ▶ Make sure that the center cover of the hub cap has been turned counter-clockwise.
- ▶ Position the hub cap and turn the center cover clockwise until the hub cap is felt and heard to engage.

Aluminum hub cap

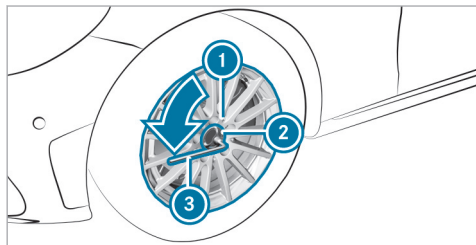

Removing:

- ▶ Position socket ② from the tire-change tool kit on hub cap ①.
- ▶ Position wheel wrench ③ on socket ②.
- ▶ Using wheel wrench ③ to turn the hub cap ① counter-clockwise and remove it.

Installing:

- ▶ Follow the instructions above in reverse order.
- ❗ **Specified tightening torque:** 18 lb-ft (25 Nm).

Raising the vehicle when changing a wheel

Requirements

- There are no persons in the vehicle.
- The vehicle has been prepared for a wheel change (→ page 429).

Important notes on using the jack:

- Use only a vehicle-specific jack that has been approved by Mercedes-Benz to raise the vehicle.
- The jack is only designed for raising and holding the vehicle for a short time while a wheel is being changed and not for maintenance work under the vehicle.
- The jack must be placed on a firm, flat and non-slip surface. If necessary, use a large, flat, load-bearing, non-slip underlay.

- The foot of the jack must be positioned vertically under the jack support point.

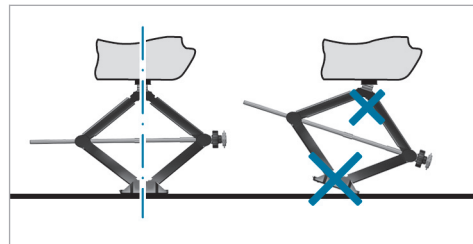

Rules of conduct when the vehicle is raised:

- Do not put your hands or feet under the vehicle.
- Do not lie under the vehicle.
- Do not start the vehicle and do not release the electric parking brake.
- Do not open or close any doors or the trunk lid.

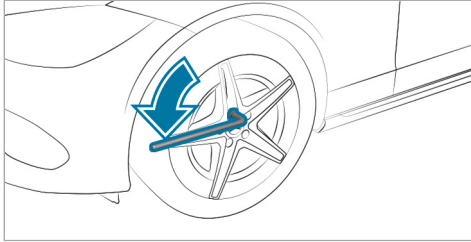

- ▶ Using the wheel wrench, loosen the wheel bolts on the wheel you wish to change by about one full turn. Do not unscrew the screws completely.

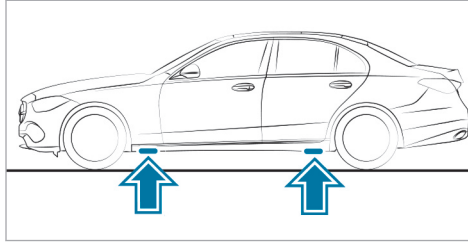

Position of the jack support points

! **NOTE** Mercedes-AMG vehicles

- ▶ Observe the notes in the Supplement. You could otherwise fail to recognize dangers.

! **WARNING** Risk of injury from incorrect positioning of the jack

If you do not position the jack correctly at the appropriate jacking point of the vehicle, the jack could tip with the vehicle raised.

- ▶ Only position the jack at the appropriate jacking point of the vehicle. The base of

the jack must be positioned vertically under the jacking point of the vehicle.

! **NOTE** Damage to the vehicle due to the jack

If you do not position the jack at the jack support points provided for this purpose, you could damage your vehicle.

- ▶ Only position the jack at the jack support points provided for this purpose.

- ▶ Take the ratchet out of the tire-change tool kit and place it on the hexagon nut of the jack so that the letters "AUF" are visible.

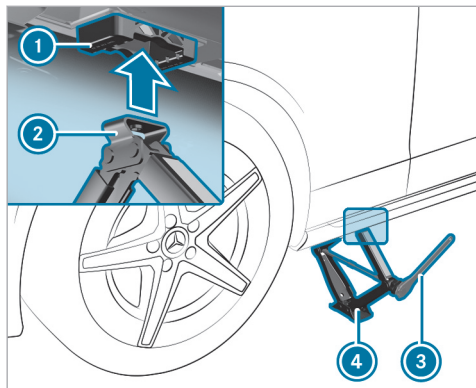

- ▶ Position support ② of jack ④ on jack support point ①.
- ▶ Turn ratchet ③ clockwise until support ② sits completely on jack support point ① and the base of the jack lies evenly on the ground.
- ▶ Turn ratchet ③ until the tire is raised a maximum of 1.2 in (3 cm) from the ground.
- ▶ Loosen and remove the wheel (→ page 432).

Removing a wheel

Requirements

- The vehicle is raised (→ page 430).

! NOTE Mercedes-AMG vehicles

- ▶ Observe the notes in the Supplement. You could otherwise fail to recognize dangers.

When changing a wheel, avoid applying any force to the brake discs, since this could impair the level of comfort when braking.

! NOTE Damage to the wheels' plastic elements when changing a wheel

Plastic elements on wheels may be damaged when removing and repositioning the wheel.

- ▶ Do not raise the wheels by the plastic elements when removing and repositioning.

! NOTE Damage to threading from dirt on wheel bolts

- ▶ Do not place wheel bolts in sand or on a dirty surface.

- ▶ Unscrew the uppermost wheel bolt completely.

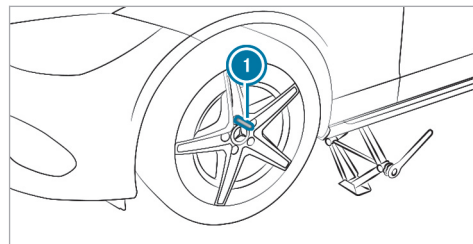

- ▶ Screw centering pin ① into the thread instead of the wheel bolt.
- ▶ Unscrew the remaining wheel bolts completely.
- ▶ Remove the wheel.

- ▶ install the new wheel (→ page 433).

Installing a new wheel

Requirements:

- The wheel to be changed is removed and the centering pin is screwed in (→ page 432).

! NOTE Mercedes-AMG vehicles

- ▶ Observe the notes in the Supplement. You could otherwise fail to recognize dangers.

! WARNING Risk of accident from losing a wheel

Oiled, greased or damaged wheel bolt/wheel nut threads or wheel hub/wheel mounting bolt threads can cause the wheel bolts/wheel nuts to come loose.

- ▶ Never oil or grease the threads.
- ▶ In the event of damage to the threads, contact a qualified specialist workshop immediately.

- ▶ Have the damaged wheel bolts or damaged hub threads replaced.
- ▶ Do not continue driving.

- ▶ Observe the notes on the choice of tires (→ page 425).

For tires with a specified direction of rotation, an arrow on the side wall of the tire indicates the correct direction of rotation. Observe the direction of rotation when installing.

! NOTE Damage to the wheels' plastic elements when changing a wheel

Plastic elements on wheels may be damaged when removing and repositioning the wheel.

- ▶ Do not raise the wheels by the plastic elements when removing and repositioning.

- ▶ Slide the wheel to be mounted onto the centering pin and push it on.

! WARNING Risk of injury from tightening wheel bolts and nuts

If you tighten the wheel bolts or wheel nuts when the vehicle is raised, the jack could tip.

- ▶ Only tighten wheel bolts or wheel nuts when the vehicle is on the ground.

- ▶ Observe the instructions and safety notes on "Changing a wheel" (→ page 425).
- ▶ For safety reasons, only use wheel bolts which have been approved by Mercedes-Benz and for the wheel in question.

! NOTE Paint damage to the rim when inserting the first wheel bolt

If the wheel has too much free play when inserting the first wheel bolt, there is a risk of damaging the paintwork on the rim.

- ▶ When inserting the first wheel bolt, be sure to apply sufficient pressure to the wheel hub.

- ▶ Tighten the wheel bolts evenly in a diagonal pattern in the order indicated until they are hand-tight.

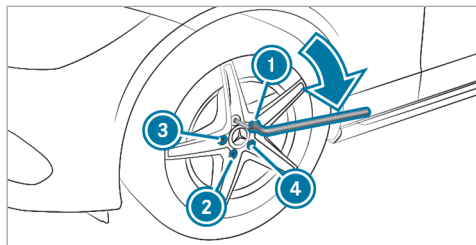

- ▶ Unscrew and remove the centering pin.
- ▶ Tighten the last wheel bolt until it is hand-tight.
- ▶ Lower the vehicle and tighten wheel bolts with the prescribed tightening torque. (→ page 434).

Lowering the vehicle after a wheel change

Requirements

- The new wheel has been installed (→ page 433).
- ▶ **To lower the vehicle:** place the ratchet onto the hexagon nut of the jack so that the letters "AB" are visible and turn counter-clockwise.

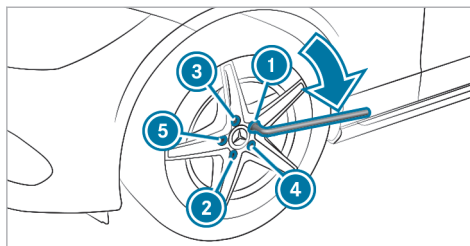

- ▶ Tighten the wheel bolts evenly in a diagonal pattern in the order indicated ① to ⑤ with an initial maximum force of 59 lb-ft (80 Nm).
- ▶ Tighten the wheel bolts evenly in a diagonal pattern in the order indicated ① to ⑤ with

the specified tightening torque of 111 lb-ft (150 Nm).

⚠ WARNING Risk of accident due to incorrect tightening torque

The wheels could come loose if the wheel bolts or wheel nuts are not tightened to the prescribed torque.

- ▶ Ensure that the wheel bolts or wheel nuts are tightened to the prescribed tightening torque.
- ▶ If you are not sure, do not move the vehicle. Contact a qualified specialist workshop and have the tightening torque checked immediately.

- ▶ Check the tire pressure of the newly installed wheel and adjust it if necessary.
- ⓘ The following does not apply if the new wheel is an emergency spare wheel:
- ▶ **Vehicles with a tire pressure loss warning system:** restart the tire pressure loss warning system (→ page 412).

- ▶ **Vehicles with a tire pressure monitoring system:** restart the tire pressure monitoring system (→ page 411).

Emergency spare wheel

Notes on the emergency spare wheel

⚠ WARNING Risk of accident caused by incorrect wheel and tire dimensions

The wheel or tire sizes and the tire type of the emergency spare wheel or spare wheel and the wheel to be replaced may differ. The emergency spare wheel or spare wheel can significantly impair driving characteristics of the vehicle.

To prevent hazardous situations:

- ▶ Drive carefully.
- ▶ Never install more than one emergency spare wheel or spare wheel that differs in size.
- ▶ Only use an emergency spare wheel or spare wheel briefly.

- ▶ Do not deactivate ESP®.
- ▶ Have the emergency spare wheel or spare wheel of a different size replaced at the nearest qualified specialist workshop. The new wheel must have the correct dimensions.

- ⓘ The emergency spare wheel is secured in the emergency spare wheel bag in the trunk.

Observe the following notes on installing an emergency spare wheel:

- The maximum permissible speed with an emergency spare wheel installed is 50 mph (80 km/h).
- Do not install the emergency spare wheel with snow chains.
- Replace the emergency spare wheel after six years at the latest, regardless of wear.
- Use the included wheel bolts for the emergency spare wheel.
- Check the tire pressure of the emergency spare wheel when installed. Correct the pressure as necessary.

- ⓘ The specified tire pressure is stated on the label of the emergency spare wheel.
- ⓘ **Vehicles with a tire pressure loss warning system warning system:** if an emergency spare wheel is installed, the tire pressure loss warning system cannot function reliably. Only restart the system when the emergency spare wheel has been replaced with a new wheel.
- Vehicles with a tire pressure monitoring system:** if an emergency spare wheel is installed, the tire pressure monitoring system cannot function reliably. For a few minutes after an emergency spare wheel is installed, the system may still display the tire pressure of the removed wheel. Only restart the system when the emergency spare wheel has been replaced with a new wheel.

Be sure to observe the following further related topics:

- Notes on tire pressure (→ page 406)
- Tire and Loading Information placard (→ page 413)
- tire pressure table (→ page 408)

436 Wheels and tires

- Notes on installing tires (→ page 425)
- installing an emergency spare wheel
(→ page 429)

Notes on technical data

! NOTE Mercedes-AMG vehicles

- ▶ Observe the notes in the Supplement. You could otherwise fail to recognize dangers.

The data stated only applies to vehicles with standard equipment. You can obtain further information from an authorized Mercedes-Benz Center.

Vehicle electronics

Two-way radios

| Notes on installing two-way radios

! WARNING Risk of accident due to improper work on two-way radios

If two-way radios are manipulated or retrofitted incorrectly, the electromagnetic radiation from the two-way radios can interfere with the

vehicle electronics and jeopardize the operating safety of the vehicle.

- ▶ You should have all work on electrical and electronic components carried out at a qualified specialist workshop.

! WARNING Risk of accident due to improper operation of two-way radios

If you use two-way radios in the vehicle improperly, their electromagnetic radiation can disrupt the vehicle's electronics. This is the case in the following situations, in particular:

- The two-way radio is not connected to an exterior antenna.
- The exterior antenna is installed incorrectly or is not a low-reflection antenna.

This could jeopardize the operating safety of the vehicle.

- ▶ Have the low-reflection exterior antenna installed at a qualified specialist workshop.

- ▶ When operating two-way radios in the vehicle, always connect them to the low-reflection exterior antenna.

! NOTE Invalidation of the operating permit due to failure to comply with the instructions for installation and use

The operating permit may be invalidated if the instructions for installation and use of two-way radios are not observed.

- ▶ Only use approved frequency bands.
- ▶ Observe the maximum permissible output power in these frequency bands.
- ▶ Only use approved antenna positions.

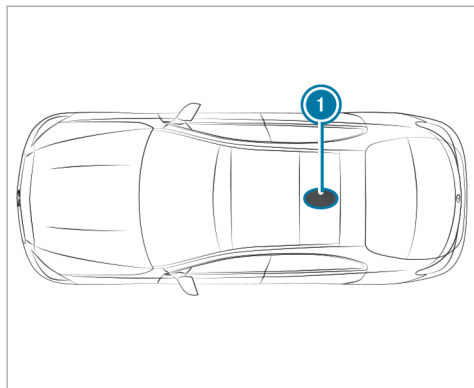

1 Rear roof area

On vehicles with a panorama roof with power tilt/sliding panel, installing an antenna to the roof area is not permitted.

Use Technical Specification ISO/TS 21609 (Road Vehicles - "EMCs for installation of aftermarket radio frequency transmitting equipment") when

retrofitting two-way radios. Comply with the legal requirements for detachable parts.

If your vehicle has a pre-installation for two-way radio equipment, use the power supply and antenna connectors provided in the pre-installation. Observe the manufacturer's supplements when installing.

Mobile phone transmission output

The maximum transmission output (PEAK) at the base of the antenna must not exceed the values in the following table.

Frequency band and maximum transmission output

Frequency band	Maximum transmission output
2-m- frequency band 144 - 174 MHz	50 W
Terrestrial Trunked Radio (TETRA) 380 - 460 MHz	10 W

Frequency band	Maximum transmission output
Mobile phone 2G	2 W
Mobile phone 3G/4G/5G	0.5 W

The following can be used in the vehicle without restrictions:

- two-way radios with a maximum transmission output of up to 100 mW
- two-way radios with transmitter frequencies in the 380 -410 MHz frequency band and a maximum transmission output of up to 2 W (TETRA)
- mobile phones (2G/3G/4G/5G)

There are no restrictions regarding the positioning of the antenna on the outside of the vehicle for the following frequency bands:

- Terrestrial Trunked Radio (TETRA)
- 2G/3G/4G/5G

Radio regulations

Regulatory radio identifiers and specific notes

Manufacturer information about radio-based vehicle components can be found using the key phrase "Regulatory radio information" in the Digital Operator's Manual in the vehicle, on the internet and in the app.

Further information and updates are available at the following web address:

[https://
regulatoryradioinformation.corpinter.net/us](https://regulatoryradioinformation.corpinter.net/us)



Information about the specific absorption rate (SAR)

Information on the specific absorption rate (SAR) can be found under the key word "Regulatory

information" in the vehicle's Digital Operator's Manual, on the Internet and in the app.

Further information and updates are available at the following web address:

[https://
regulatoryradioinformation.corpinter.net/us](https://regulatoryradioinformation.corpinter.net/us)



Vehicle identification plate, VIN and engine number overview

Vehicle identification plate

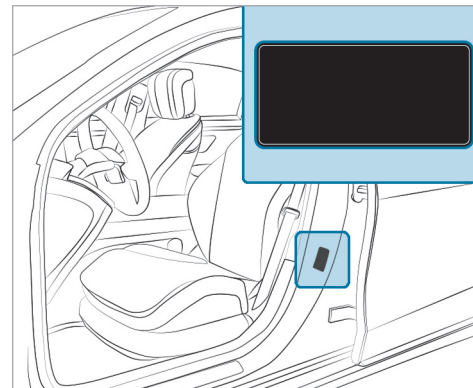

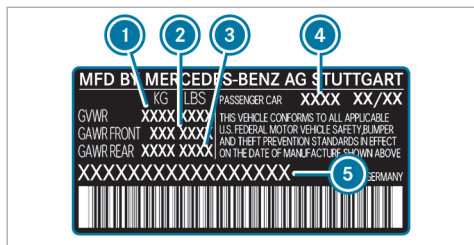

Vehicle identification plate (USA only)

- ① Gross vehicle weight rating
- ② Maximum permissible front axle load
- ③ Maximum permissible rear axle load
- ④ Paint code
- ⑤ VIN (vehicle identification number)

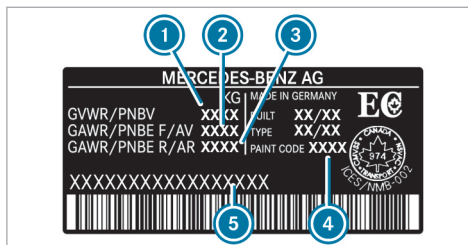

Vehicle identification plate (Canada only)

- ① Gross vehicle weight rating
- ② Maximum permissible front axle load
- ③ Maximum permissible rear axle load
- ④ Paint code
- ⑤ VIN (vehicle identification number)

The gross vehicle weight rating comprises the vehicle weight, all vehicle occupants, the fuel and the load. The gross axle weight rating is the maximum weight that can be carried on one axle (front or rear axle).

Do not exceed the gross vehicle weight rating or the gross axle weight rating for the front or rear axle.

VIN below the right front seat

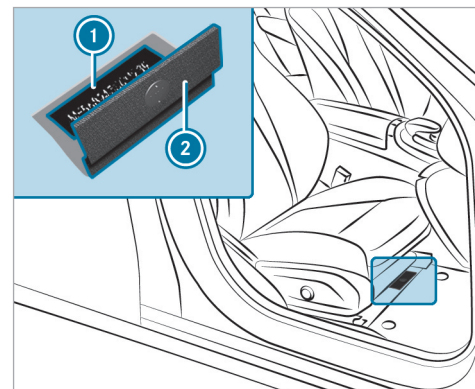

- ① Imprinted VIN (vehicle identification number)
- ② Floor covering

Additional plates

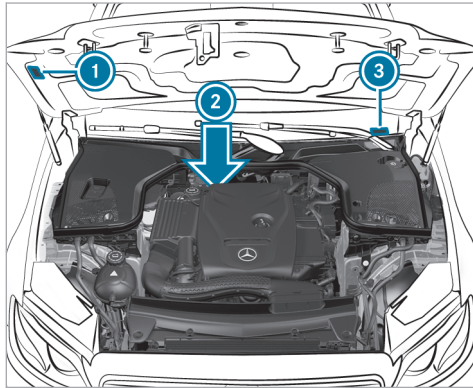

- ① Plate with information regarding emissions testing, including confirmation of emissions guidelines at the U.S. federal level and for California
- ② Engine number stamped into the crankcase
- ③ VIN (vehicle identification number) as a label at the lower edge of the windshield

Operating fluids

Notes on operating fluids

! NOTE Mercedes-AMG vehicles

- ▶ Observe the notes in the Supplement. You could otherwise fail to recognize dangers.

! WARNING Risk of injury due to harmful operating fluids

Operating fluids can be toxic.

- ▶ When using, storing and disposing of operating fluids, observe the imprints on the respective original containers.
- ▶ Always keep operating fluids in the sealed original container.
- ▶ Always keep children away from operating fluids.

! ENVIRONMENTAL NOTE Pollution of the environment due to irresponsible disposal of operating fluids

Incorrect disposal of operating fluids can cause considerable damage to the environment.

- ▶ Dispose of operating fluids in an environmentally responsible manner.

Operating fluids include the following:

- Fuels
- Lubricants
- Coolant
- Brake fluid
- Windshield washer fluid
- Climate control system refrigerant

Only use products approved by Mercedes-Benz. Damage caused by the use of products that have not been approved is not covered by the Mercedes-Benz warranty or goodwill gestures.

The operating fluids approved by Mercedes-Benz can be identified by the following inscriptions on the container:

- MB-Freigabe (e.g. MB-Freigabe 229.51)
- MB-Approval (e.g. MB-Approval 229.51)

Further information on approved operating fluids:

- in the Mercedes-Benz Specifications for Operating Fluids by entering the designation
 - At <https://operatingfluids.mercedes-benz.com>
- At a qualified specialist workshop

▲ WARNING Risk of fire or explosion from fuel

Fuels are highly flammable.

- ▶ Fire, open flames, smoking and creating sparks must be avoided.
- ▶ Before and during refueling, switch off the vehicle and, if installed, the stationary heater.

▲ WARNING Risk of injury from fuels

Fuels are poisonous and hazardous to your health.

- ▶ Do not swallow fuel or let it come into contact with skin, eyes or clothing.
- ▶ Do not inhale fuel vapor.
- ▶ Keep children away from fuel.
- ▶ Keep doors and windows closed during the refueling process.

If you or other people come into contact with fuel, observe the following:

- ▶ Immediately rinse fuel off your skin with soap and water.
- ▶ If fuel comes into contact with your eyes, immediately rinse them thoroughly with clean water. Seek medical attention immediately.
- ▶ If you swallow fuel, seek medical attention immediately. Do not induce vomiting.

- ▶ Change immediately out of clothing that has come into contact with fuel.

Flexible-fuel vehicles can be refueled with the following fuel types:

- premium-grade unleaded gasoline
- E85 fuel
- a mixture of E85 fuel and premium-grade unleaded gasoline

Flexible-fuel vehicles can be identified by the **Ethanol up to E85** sticker on the inside of the fuel filler flap.

Depending on the country, the fuels you can use in your vehicle may differ from the information in the Operator's Manual. The fuels that have been approved for your vehicle can be found on the instruction label on the inside of the fuel filler flap.

Fuel

Information on fuel quality for vehicles with gasoline engine

Observe the notes on operating fluids (→ page 441).

! NOTE Damage caused by the wrong fuel

Even small amounts of the wrong fuel could result in damage to the fuel system, the engine and the emission control system.

- ▶ Refuel only with low-sulfur spark-ignition engine fuel.

This fuel may contain up to 10% ethanol by volume. Your vehicle is suitable for use with E10 fuel.

Never refuel with any of the following fuels:

- Diesel
- gasoline with more than 10% Ethanol, z.B. E15, E85, E100

- gasoline with more than 3% methanol by volume, e.g. M15, M30, M85, M100
- gasoline with metallic additives

If you have accidentally refueled with the wrong fuel:

- ▶ Do not switch on the vehicle.
- ▶ Consult a qualified specialist workshop.

If the available fuel is not sufficiently low in sulfur, it may produce unpleasant odors.

Refuel only with fuel that has at least the octane number specified on the information label on the fuel filler flap (→ page 201).

For maximum engine output: Refuel only with premium-grade gasoline with an octane number of at least 91 AKI/95 RON.

If the recommended fuel is not available, you may also temporarily use regular unleaded gasoline with an octane number of at least 87 AKI/91 RON. This may reduce engine output and increase fuel consumption.

Never refuel using gasoline with an even lower RON.

! NOTE Premature engine wear through unleaded regular gasoline

Impairment of the longevity and performance of the engine.

If unleaded premium grade gasoline is unavailable and you have to refuel using unleaded regular gasoline:

- ▶ Only fill the fuel tank to half full with unleaded regular gasoline and refill as soon as possible with unleaded premium grade gasoline.
- ▶ Do not drive at the maximum design speed.
- ▶ Avoid sudden acceleration and engine speeds over 3000 rpm.

Further information on fuel is available in the following locations:

- At a gas station
- At a qualified specialist workshop
- **USA only:** On the <https://www.mbUSA.com>

Information on additives in gasoline (vehicles with gasoline engine)

Observe the notes on operating fluids (→ page 441).

! **NOTE** Damage from use of unsuitable additives

Even small amounts of the wrong additive may lead to malfunctions occurring.

▶ Only add cleaning additives recommended by Mercedes-Benz to the fuel.

Mercedes-Benz recommends that you use brand-name fuels with additives.

In some countries, the fuel available may not have sufficient additives. Deposits could build up in the fuel injection system as a result. In this case, in consultation with a qualified specialist workshop (e.g. an authorized Mercedes-Benz Service Center), mix the fuel with the cleaning additive recommended by Mercedes-Benz. Observe the notes and mixing ratios indicated on the tank.

Tank content and fuel reserve

Total fuel tank capacity

Model	
All models	17.4 gal (66.0 liters)

Fuel tank reserve

Model	
All models	1.9 gal (7.0 liters)

Engine oil

Notes on engine oil

Observe the notes on operating fluids (→ page 441).



! **NOTE** Engine damage caused by an incorrect oil filter, incorrect oil or additives

- ▶ Do not use engine oils or oil filters other than those which meet the specifications necessary for the prescribed service intervals.
- ▶ Do not alter the engine oil or oil filter in order to achieve longer change intervals than prescribed.
- ▶ Do not use additives.
- ▶ Have the engine oil changed after the prescribed intervals.

Mercedes-Benz recommends having the oil changed at a qualified specialist workshop.

Only use engine oils approved for your vehicle by Mercedes-Benz.

■ Engine oil quality and filling quantity

Engine oil specification

Model	MB-Freigabe or MB-Approval
All models	229.71, 229.72*

* Recommended for the lowest possible fuel consumption (lowest SAE viscosity class in each case; observe possible restrictions of the approved SAE viscosity classes).

Only use engine oils of viscosity class SAE 0W-20.

Engine oil filling quantity

Model	Filling quantity
All models	6.3 US qt (6.0 liters)

The specified filling quantity refers to an oil change with replacement of the oil filter.

Notes on brake fluid

Please observe the notes on operating fluids (→ page 441).

⚠ WARNING Risk of an accident due to vapor pockets forming in the brake system

The brake fluid constantly absorbs moisture from the air. This lowers the boiling point of the brake fluid. If the boiling point is too low, vapor pockets may form in the brake system when the brakes are applied hard.

This causes the braking effect to be impaired.

- ▶ Have the brake fluid renewed at the specified intervals.

Have the brake fluid regularly replaced at a qualified specialist workshop.

Only use a brake fluid according to MB-Freigabe or MB-Approval 331.0 approved by Mercedes-Benz.

Coolant

■ Notes on coolant

Observe the notes on operating fluids (→ page 441).

⚠ WARNING - Risk of fire and injury from antifreeze

If antifreeze comes into contact with hot component parts in the engine compartment, it may ignite.

- ▶ Allow the engine to cool down before adding antifreeze.
- ▶ Make sure that no antifreeze spills out next to the filler opening.
- ▶ Thoroughly clean off any antifreeze from component parts before starting the vehicle.

! NOTE Damage caused by incorrect coolant

- ▶ Only use coolant that has been premixed with the required antifreeze protection.

Information on coolant is available at the following locations:

- In the Mercedes-Benz Specification for Operating Fluids 320.1
 - At <https://operatingfluids.mercedes-benz.com>
- At a qualified specialist workshop

NOTE Overheating at high outside temperatures

If an inappropriate coolant is used, the cooling system is not sufficiently protected against overheating and corrosion at high outside temperatures.

- ▶ Only use coolant approved for Mercedes-Benz.
- ▶ Observe the instructions in the Mercedes-Benz Specifications for Operating Fluids 320.1.

Have the coolant regularly replaced at a qualified specialist workshop.

Proportion of antifreeze concentrate in the cooling system:

- A minimum of 50% (antifreeze protection down to about -35°F (-37°C))
- A maximum of 55% (antifreeze protection down to -49°F (-45°C))

Coolant filling capacity

Coolant

Model	Filling capacity
All models	12.7 US qt (12.0 liters)

Notes on windshield washer fluid

Observe the notes on operating fluids (→ page 441).

WARNING - Risk of fire and injury from windshield washer concentrate

Windshield washer concentrate is highly flammable. It could ignite if it comes into contact with hot engine component parts or the exhaust system.

- ▶ Make sure that no windshield washer concentrate spills out next to the filler opening.

NOTE Damage to the exterior lighting due to unsuitable windshield washer fluid

Unsuitable windshield washer fluid may damage the plastic surface of the exterior lighting.

- ▶ Only use windshield washer fluid which is also suitable for use on plastic surfaces, e.g. MB SummerFit or MB WinterFit.

! **NOTE** Blocked spray nozzles caused by mixing windshield washer fluids

▶ Do not mix MB SummerFit and MB WinterFit with other windshield washer fluids.

Do not use distilled or de-ionised water. Otherwise, the fill level sensor may be triggered erroneously.

Recommended windshield washer fluid:

- Above freezing point: e.g. MB SummerFit
- Below freezing point: e.g. MB WinterFit

For the correct mixing ratio, refer to the information on the antifreeze container.

Mix washing water with windshield washer fluid all year round.

Refrigerant

Notes on refrigerant

Observe the notes on operating fluids (→ page 441).

! **NOTE** Damage due to incorrect refrigerant

If a non-approved refrigerant is used, the climate control system may be damaged.

▶ Use only R-1234yf refrigerant.

! **NOTE** Damage to the climate control system due to incorrect refrigerant compressor oil

- ▶ Only use refrigerant compressor oil that has been approved by Mercedes-Benz.
- ▶ Do not mix the approved refrigerant compressor oil with a different refrigerant compressor oil.

Work on the climate control system may be carried out only at a qualified specialist workshop. All applicable regulations, as well as SAE standard J639, must be adhered to.

The information label on the climate control system for the refrigerant type and the refrigerant compressor oil (PAG oil) is located on the inside of the hood.

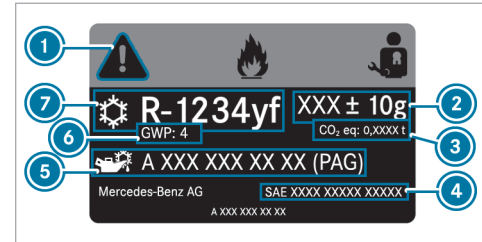

Information label

- ① Hazard and service warning symbols
- ② Refrigerant filling capacity
- ③ CO₂ equivalent of the refrigerant used
- ④ Applicable standards
- ⑤ PAG oil part number
- ⑥ GWP (global warming potential) of the refrigerant used
- ⑦ Refrigerant type

Symbols ① indicate the following:

- Possible dangers

448 Technical data

- Maintenance work to be carried out at a qualified specialist workshop

Filling capacity for refrigerant and PAG oil

Refrigerant filling capacity

Model	
All models	20.1 ± 0.4 oz (570 ± 10 g)

Filling quantity for PAG oil

Model	
All models	2.8 ± 0.4 oz (80 ± 10 g)

Vehicle data

Vehicle dimensions

The heights specified may vary as a result of the following factors:

- Tires
- Load

- Condition of the suspension
- Special equipment

Vehicle dimensions

All models	Vehicle dimensions
Vehicle length	187.0 in (4751 mm)
Vehicle width including exterior mirrors	80.0 in (2033 mm)
Vehicle height	56.7 in (1440 mm)
Wheelbase	112.8 in (2865 mm)

Turning circle

Model	Turning circle
C 300	36.32 ft (11.07 m)
C 300 4MATIC	37.57 ft (11.45 m)

Weights and loads

Bear in mind that items of special equipment will increase the curb weight and reduce the payload.

Vehicle-specific weight information can be found on the vehicle identification plate.

Display messages

Introduction



Information about display messages



Display messages appear on the driver display.

Display messages with graphical symbols are simplified in the Operator's Manual and may differ from the symbols on the driver display. The driver display shows high-priority display messages in red. Certain display messages will be accompanied by a warning tone.

Please act in accordance with the display messages and follow the additional notes in the Operator's Manual.

For some display messages, symbols will also be shown:

-  Further information
-  Hide display message

You can select the respective symbol by swiping left or right on the left-hand Touch Control. Press  to display further information on the central display. Press  to hide the display message.

You can hide display messages to be acknowledged by pressing the back button  or with the left-hand Touch Control. The display messages will then be stored in the message memory.

Rectify the cause of a display message as quickly as possible.

High-priority display messages cannot be hidden. The driver display will show these display messages continuously until the cause of the display message has been rectified.



Calling up saved display messages

Driver display:

 **Service**

The **Message Memory: XX** message appears on the driver display.

 Scroll through the display messages by swiping upwards or downwards on the left-hand Touch Control.

 **To exit the display:** press the  back button.

Occupant safety

Display messages	Possible causes/consequences and ► Solutions
 <p data-bbox="144 384 413 436">Restraint System Malfunction Service Required</p>	<p data-bbox="474 291 1003 317">* The restraint system is malfunctioning (→ page 43).</p> <div data-bbox="500 335 1646 451"><p data-bbox="506 342 1212 368">⚠ WARNING Risk of injury due to malfunctions in the restraint system</p><p data-bbox="511 382 1578 408">Components in the restraint system may be activated unintentionally or not deploy as planned in an accident.</p><ul data-bbox="511 415 1472 441" style="list-style-type: none">► Have the restraint system checked and repaired immediately at a qualified specialist workshop.</div> <p data-bbox="493 469 635 495">Plug-in hybrid:</p> <div data-bbox="500 513 1646 746"><p data-bbox="506 521 1193 547">⚠ DANGER Risk of death due to the restraint system malfunctioning</p><p data-bbox="511 560 1609 612">Components in the restraint system may be activated unintentionally or not deploy as intended in an accident. In the event of an accident, the high-voltage on-board electrical system may not be deactivated as intended.</p><p data-bbox="511 622 1600 674">You may receive an electric shock if you touch the damaged components of the high-voltage on-board electrical system.</p><ul data-bbox="511 681 1472 743" style="list-style-type: none">► Have the restraint system checked and repaired immediately at a qualified specialist workshop.► After an accident, switch off the vehicle immediately.</div>

Display messages



Front Left Malfunction
Service Required (example)

Possible causes/consequences and ► Solutions

* The restraint system is malfunctioning (→ page 43).

▲ WARNING Risk of injury due to malfunctions in the restraint system

Components in the restraint system may be activated unintentionally or not deploy as planned in an accident.

- Have the restraint system checked and repaired immediately at a qualified specialist workshop.

Plug-in hybrid:**▲ DANGER** Risk of death due to the restraint system malfunctioning

Components in the restraint system may be activated unintentionally or not deploy as intended in an accident. In the event of an accident, the high-voltage on-board electrical system may not be deactivated as intended.

You may receive an electric shock if you touch the damaged components of the high-voltage on-board electrical system.

- Have the restraint system checked and repaired immediately at a qualified specialist workshop.
- After an accident, switch off the vehicle immediately.

Display messages	Possible causes/consequences and ► Solutions
 <p data-bbox="144 342 393 422">Left Window Airbag Malfunction Service Required (example)</p>	<p data-bbox="476 249 1003 275">* The restraint system is malfunctioning (→ page 43).</p> <div data-bbox="500 291 1648 436" style="border: 1px solid gray; padding: 5px;"> <p data-bbox="506 301 1411 327">▲ WARNING Risk of injury or fatal injury due to a malfunction in the window curtain airbag</p> <p data-bbox="506 342 1578 389">The window curtain airbag might be triggered unintentionally or might not be triggered at all in the event of an accident.</p> <p data-bbox="506 399 1530 425">► Have the window curtain airbag checked and repaired immediately at a qualified specialist workshop.</p> </div>
<p data-bbox="144 453 426 526">Front Passenger Airbag Disabled See Operator's Manual</p>	<p data-bbox="476 453 1548 500">* The front passenger air bag has been disabled even though an adult or a person of adult build is on the front passenger seat. If additional forces are applied to the seat, the weight the system detects may be too low.</p> <div data-bbox="500 519 1648 726" style="border: 1px solid gray; padding: 5px;"> <p data-bbox="506 529 1319 555">▲ WARNING Risk of injury or fatal injury due to a disabled front passenger airbag</p> <p data-bbox="506 570 1633 617">If the front passenger airbag is disabled, the front passenger airbag will not be deployed in the event of an accident and cannot perform its intended protective function.</p> <p data-bbox="506 632 1605 679">A person in the front passenger seat could then, for example, come into contact with the vehicle's interior, especially if the person is sitting too close to the cockpit.</p> <p data-bbox="506 689 1544 715">► Make sure, both before and during the journey, that the status of the front passenger airbag is correct.</p> </div> <ul data-bbox="495 741 1267 872" style="list-style-type: none"> <li data-bbox="495 741 1215 767">► Stop the vehicle immediately in accordance with the traffic conditions. <li data-bbox="495 778 1215 803">► Make sure that no objects are trapped under the front passenger seat. <li data-bbox="495 814 1267 840">► Check the status of automatic front passenger air bag shutoff (→ page 45). <li data-bbox="495 850 1160 872">► If necessary, consult a qualified specialist workshop immediately.



Display messages	Possible causes/consequences and ► Solutions
<p data-bbox="194 248 434 326">Front Passenger Airbag Enabled See Operator's Manual</p>	<p data-bbox="526 248 1506 274">* The front passenger air bag will be enabled while the vehicle is in motion in the following situations:</p> <ul data-bbox="545 284 1690 372" style="list-style-type: none"> <li data-bbox="545 284 1690 336">• Even when a child, a small adult or an object weighing less than the system weight threshold is located on the front passenger seat <li data-bbox="545 347 1081 372">• Even when the front passenger seat is not occupied <p data-bbox="545 388 1413 414">The system may detect objects or forces that are adding to the weight applied to the seat.</p> <div data-bbox="554 429 1690 497" style="background-color: #f0f0f0; padding: 5px;"> <p data-bbox="563 440 1672 492">▲ WARNING Risk of injury or death when using a child restraint system while the front passenger airbag is enabled</p> </div> <p data-bbox="563 507 1672 559">If you secure a child in a child restraint system on the front passenger seat and the front passenger airbag is enabled, the front passenger airbag can deploy in the event of an accident.</p> <p data-bbox="563 569 951 595">The child could be struck by the airbag.</p> <p data-bbox="563 606 1561 631">► Ensure, both before and during the journey, that the status of the front passenger airbag is correct.</p> <p data-bbox="563 647 1635 699">NEVER use a rearward facing child restraint on a seat protected by an ACTIVE AIRBAG in front of it, DEATH or SERIOUS INJURY to the CHILD can occur.</p> <ul data-bbox="545 720 1321 854" style="list-style-type: none"> <li data-bbox="545 720 1265 751">► Stop the vehicle immediately in accordance with the traffic conditions. <li data-bbox="545 761 1265 787">► Make sure that no objects are trapped under the front passenger seat. <li data-bbox="545 797 1321 823">► Check the status of automatic front passenger air bag shutoff (→ page 45). <li data-bbox="545 833 1210 854">► If necessary, consult a qualified specialist workshop immediately.



454 Display messages and warning/indicator lamps



Display messages	Possible causes/consequences and ► Solutions
<p>Occupant Presence Reminder Inoperative</p>	<ul style="list-style-type: none">* The occupant presence reminder is malfunctioning.<ul style="list-style-type: none">► Consult a qualified specialist workshop.
<p> Do Not Leave People or Animals in the Vehicle</p>	<ul style="list-style-type: none">* The occupant presence reminder suspects that there are persons or animals in the rear of the vehicle.<ul style="list-style-type: none">► Do not leave any persons or animals behind when leaving the vehicle.



SmartKey





Display messages	Possible causes/consequences and ► Solutions
<p> Replace Key Battery</p>	<ul style="list-style-type: none">* The key battery is discharged.<ul style="list-style-type: none">► Replace the battery (→ page 75).

Display messages	Possible causes/consequences and ► Solutions
 <p data-bbox="195 342 439 394">Key Not Detected (white display message)</p>	<ul style="list-style-type: none"> <li data-bbox="522 249 857 273">* The key is currently undetected. <li data-bbox="543 283 1018 307">► Change the location of the key in the vehicle. <li data-bbox="543 318 805 341">► Try to start the vehicle. <li data-bbox="543 352 1434 376">► If the key is still not detected, place it in the slot for starting with the key (→ page 178). <li data-bbox="543 386 746 410">► Start the vehicle.
 <p data-bbox="195 523 463 574">Key Not Detected (red display message)</p>	<ul style="list-style-type: none"> <li data-bbox="522 429 1400 453">* The key can no longer be detected during a journey and may no longer be in the vehicle. <p data-bbox="543 464 1190 487">If the key is no longer in the vehicle and you switch off the vehicle:</p> <ul style="list-style-type: none"> <li data-bbox="552 498 925 522">• You can no longer start the vehicle. <li data-bbox="552 532 944 556">• You cannot centrally lock the vehicle. <ul style="list-style-type: none"> <li data-bbox="543 577 931 600">► Ensure that the key is in the vehicle. <p data-bbox="543 621 1031 645">If the key is in the vehicle and is still not detected:</p> <ul style="list-style-type: none"> <li data-bbox="543 655 1264 679">► Stop the vehicle immediately in accordance with the traffic conditions. <li data-bbox="543 689 1308 713">► Place the key in the slot for starting the engine with the key (→ page 178). <p data-bbox="543 744 920 768">The key battery is weak or discharged.</p> <ul style="list-style-type: none"> <li data-bbox="543 779 1134 802">► Check the battery using the indicator lamp (→ page 73). <li data-bbox="543 813 1077 837">► Replace the key battery, if necessary (→ page 75).





Display messages	Possible causes/consequences and ► Solutions
 <p data-bbox="144 339 415 366">Initializing Key Please Wait</p>	<ul style="list-style-type: none"> * The vehicle is processing in order to teach in the new key. <ul style="list-style-type: none"> ► Wait until processing is complete.
 <p data-bbox="144 478 369 505">Don't Forget Your Key</p>	<ul style="list-style-type: none"> * A warning tone also sounds. This message reminds you to take your key with you when you leave the vehicle.
<p data-bbox="144 529 415 609">Place the Key in the Marked Space See Operator's Manual</p>	<ul style="list-style-type: none"> * Key detection is malfunctioning. <ul style="list-style-type: none"> ► Change the location of the key in the vehicle. ► Place the key in the slot for starting the engine with the key (→ page 178).
<p data-bbox="144 640 415 771">Searching for Key in Stowage Tray or Digital Vehicle Key in Inductive Charging Bracket... See Operator's Manual</p>	<ul style="list-style-type: none"> * The key has not been detected. <ul style="list-style-type: none"> ► Place the key in the marked space (→ page 178). <p data-bbox="495 726 785 753">If the key is still not detected:</p> <ul style="list-style-type: none"> ► Consult a qualified specialist workshop. * The Digital Vehicle Key has not been detected. <ul style="list-style-type: none"> ► Place the Digital Vehicle Key in the marked space (→ page 177).

Display messages	Possible causes/consequences and ► Solutions
 <p data-bbox="195 417 375 441">Key Not Detected</p>	<p data-bbox="543 249 981 273">If the Digital Vehicle Key is still not detected:</p> <ul style="list-style-type: none"> <li data-bbox="543 282 966 306">► Consult a qualified specialist workshop. <p data-bbox="524 325 1105 349">* The key or the Digital Vehicle Key is currently undetected.</p> <ul style="list-style-type: none"> <li data-bbox="543 358 1267 382">► Change the location of the key or the Digital Vehicle Key in the vehicle. <li data-bbox="543 391 805 415">► Try to start the vehicle. <li data-bbox="543 424 1356 448">► If the key is still not detected, place the key in the marked space (→ page 178). <li data-bbox="543 457 1650 481">► If the Digital Vehicle Key is still not detected, place the Digital Vehicle Key in the marked space (→ page 177). <li data-bbox="543 491 746 514">► Start the vehicle.
 <p data-bbox="195 635 436 707">Key Not Detected Place Digital Vehicle Key in Mobile Phone Cradle</p>	<p data-bbox="524 539 1600 563">* The key or the Digital Vehicle Key is no longer detected during a journey and may no longer be in the vehicle.</p> <p data-bbox="543 572 1439 596">If the key or the Digital Vehicle Key is no longer in the vehicle and you switch off the vehicle:</p> <ul style="list-style-type: none"> <li data-bbox="543 606 1023 629">• You will no longer be able to start the vehicle. <li data-bbox="543 639 1045 663">• You will not be able to lock the vehicle centrally. <ul style="list-style-type: none"> <li data-bbox="543 682 1180 706">► Ensure that the key or the Digital Vehicle Key is in the vehicle. <p data-bbox="543 736 1280 760">If the key or the Digital Vehicle Key is in the vehicle and is still not detected:</p> <ul style="list-style-type: none"> <li data-bbox="543 769 1267 793">► Stop the vehicle immediately in accordance with the traffic conditions. <li data-bbox="543 802 1064 826">► Place the key in the marked space (→ page 178). <li data-bbox="543 836 1212 859">► Place the Digital Vehicle Key in the marked space (→ page 177).

Display messages	Possible causes/consequences and ► Solutions
	<p>The key battery is weak or discharged.</p> <ul style="list-style-type: none"> ► Check the battery using the indicator lamp (→ page 73). ► Replace the key battery, if necessary (→ page 75). <p>The state of charge of the rechargeable battery of the end device with the Digital Vehicle Key is too low.</p> <ul style="list-style-type: none"> ► Immediately charge the rechargeable battery of the Digital Vehicle Key end device. <p>Otherwise, it may not be possible to restart the vehicle after it has been switched off.</p> <p>If the key or the Digital Vehicle Key is still not detected:</p> <ul style="list-style-type: none"> ► Consult a qualified specialist workshop.
 <p>Replace SmartKey See Operator's Manual</p>	<ul style="list-style-type: none"> * If the Digital Vehicle Key is not renewed, the vehicle cannot be unlocked/locked or started. ► The system will automatically renew the Digital Vehicle Key. When renewal is complete, the message will disappear and the Digital Vehicle Key will be available again.
 <p>Take SmartKey With You</p>	<ul style="list-style-type: none"> * A warning tone also sounds. This message reminds you to take your key with you when you leave the vehicle. This also applies to the Digital Vehicle Key.

Display messages	Possible causes/consequences and ► Solutions
 <p data-bbox="195 342 462 391">Digital Vehicle Key Charge Device</p>	<ul style="list-style-type: none"> <li data-bbox="522 249 1552 275">* The state of charge of the rechargeable battery of the end device with the Digital Vehicle Key is too low. <li data-bbox="543 280 1382 306">► Immediately charge the rechargeable battery of the Digital Vehicle Key end device.
 <p data-bbox="195 511 462 537">Initializing Key Please Wait</p>	<ul style="list-style-type: none"> <li data-bbox="522 418 1252 444">* The vehicle is processing in order to teach in the new Digital Vehicle Key. <li data-bbox="543 449 907 475">► Wait until processing is complete.
 <p data-bbox="195 653 436 702">Key Does Not Belong to Vehicle</p>	<ul style="list-style-type: none"> <li data-bbox="522 560 1036 586">* The vehicle cannot be unlocked/locked or started. <li data-bbox="543 591 1086 617">► Use the Digital Vehicle Key belonging to the vehicle.
 <p data-bbox="195 822 376 848">Obtain a New Key</p>	<ul style="list-style-type: none"> <li data-bbox="522 729 768 755">* Have the key replaced. <li data-bbox="543 760 966 786">► Consult a qualified specialist workshop.

Lights



Display messages	Possible causes/consequences and ► Solutions
 <p data-bbox="144 384 384 433">Malfunction See Operator's Manual</p>	<ul style="list-style-type: none"> <li data-bbox="469 293 864 319">* The exterior lighting is malfunctioning. <li data-bbox="495 324 912 350">► Consult a qualified specialist workshop.
 <p data-bbox="144 553 395 601">Automatic Driving Lights Inoperative</p>	<ul style="list-style-type: none"> <li data-bbox="469 462 1092 487">* The light sensor for automatic driving lights is malfunctioning. <li data-bbox="495 493 912 519">► Consult a qualified specialist workshop.
 <p data-bbox="144 722 362 747">Switch On Headlights</p>	<ul style="list-style-type: none"> <li data-bbox="469 630 935 656">* You are driving without low-beam headlamps. <li data-bbox="495 662 1023 687">► Turn the light switch to the  or AUTO position.



Display messages	Possible causes/consequences and ► Solutions
 <p data-bbox="194 341 369 367">Switch Off Lights</p>	<ul style="list-style-type: none"> <li data-bbox="517 248 1145 274">* You are leaving the vehicle and the lights are still switched on. <ul style="list-style-type: none"> <li data-bbox="545 279 988 305">► Turn the light switch to the AUTO position.
<p data-bbox="194 388 452 440">DIGITAL LIGHT Functions Limited</p>	<ul style="list-style-type: none"> <li data-bbox="517 388 1672 440">* The DIGITAL LIGHT system is malfunctioning. The lighting system will continue to work even without the functions of the DIGITAL LIGHT system. <ul style="list-style-type: none"> <li data-bbox="545 450 970 476">► Consult a qualified specialist workshop.
<p data-bbox="194 492 462 569">Adaptive Highbeam Assist Plus Currently Unavailable See Operator's Manual</p>	<ul style="list-style-type: none"> <li data-bbox="517 492 1635 616">* Adaptive Highbeam Assist Plus is temporarily unavailable. The system limits have been reached (→ page 148). Once the cause of the problem is no longer present, the system will be available again. The Adaptive Highbeam Assist Plus Now Available display message will appear. <ul style="list-style-type: none"> <li data-bbox="545 621 665 647">► Drive on <li data-bbox="545 657 1432 683">► Operate the high beam manually until Adaptive High Beam Assist Plus is available again.
<p data-bbox="194 699 462 751">Adaptive Highbeam Assist Plus Inoperative</p>	<ul style="list-style-type: none"> <li data-bbox="517 699 1386 854">* Adaptive Highbeam Assist Plus is malfunctioning. <ul style="list-style-type: none"> <li data-bbox="545 730 665 756">► Drive on <li data-bbox="545 766 572 792">or <li data-bbox="545 802 1367 828">► Stop the vehicle in accordance with the traffic conditions and restart the vehicle. <li data-bbox="545 833 1386 859">► If the display message does not disappear: consult a qualified specialist workshop.

Display messages	Possible causes/consequences and ► Solutions
 <p>Check Left Low Beam (example)</p>	<ul style="list-style-type: none"> ► Until then, operate the high beam manually. <p>* The corresponding light source is defective.</p> <ul style="list-style-type: none"> ► Drive on carefully. ► Consult a qualified specialist workshop immediately. <p>ⓘ LED light sources: the display message for the corresponding light appears only when all the light-emitting diodes in the light are faulty.</p>
<p>Adaptive Highbeam Assist Currently Unavailable See Operator's Manual</p>	<p>* Adaptive Highbeam Assist is temporarily unavailable. The system limits have been reached (→ page 147). Once the cause of the problem is no longer present, the system will be available again. The Adaptive Highbeam Assist Now Available display message will appear.</p> <ul style="list-style-type: none"> ► Drive on ► Operate the high beam manually until Adaptive High Beam Assist is available again.
<p>Adaptive Highbeam Assist Inoperative</p>	<p>* Adaptive Highbeam Assist is malfunctioning.</p> <ul style="list-style-type: none"> ► Drive on <p>or</p> <ul style="list-style-type: none"> ► Stop the vehicle in accordance with the traffic conditions and restart the vehicle. ► If the display message does not disappear: consult a qualified specialist workshop. ► Until then, operate the high beam manually.



Display messages	Possible causes/consequences and ► Solutions
Hazard Warning Light Malfunction	<ul style="list-style-type: none"> * The hazard warning lamp switch is malfunctioning. <ul style="list-style-type: none"> ► Consult a qualified specialist workshop.

Climate control

Display messages	Possible causes/consequences and ► Solutions
 <p>Currently Not Available Charging of the High-voltage Battery Not Completed</p>	<ul style="list-style-type: none"> * The high-voltage battery is charging. Pre-entry climate control cannot be switched on. <ul style="list-style-type: none"> ► Wait until the charging process has achieved a minimum state of charge.
 <p>Currently Not Available Charge High-voltage Battery</p>	<ul style="list-style-type: none"> * The charge of the high-voltage battery is too low. Pre-entry climate control cannot be switched on. <ul style="list-style-type: none"> ► Charge the high-voltage battery (→ page 204).

Display messages	Possible causes/consequences and ► Solutions
 <p data-bbox="144 342 410 418">Pre-entry Climate Control Available Again via Smart-Key after Vehicle Start</p>	<ul style="list-style-type: none"><li data-bbox="476 249 1511 332">* You have attempted to switch on pre-entry climate control more than twice with the vehicle switched off.<ul style="list-style-type: none"><li data-bbox="495 280 975 332">► Start the vehicle for ten seconds. Pre-entry climate control is operational again.
 <p data-bbox="144 539 421 640">Pre-entry Climate Control via SmartKey Currently Not Available. High-voltage Battery Low</p>	<ul style="list-style-type: none"><li data-bbox="476 446 1541 529">* The charge of the high-voltage battery is too low. Pre-entry climate control cannot be switched on.<ul style="list-style-type: none"><li data-bbox="495 477 1541 529">► Charge the high-voltage battery (→ page 204). When the high-voltage battery is sufficiently charged, pre-entry climate control will be operational again.



Drive system

Display messages	Possible causes/consequences and ► Solutions
 <p data-bbox="194 383 462 435">Towing Not Permitted See Operator's Manual</p>	<ul style="list-style-type: none"> * The drive system is malfunctioning. <ul style="list-style-type: none"> ► Have the vehicle transported only using a transporter or trailer (→ page 397).
 <p data-bbox="194 554 462 606">Acoustic Presence Indicator Inoperative</p>	<ul style="list-style-type: none"> * The sound generator (acoustic vehicle warning system) is malfunctioning. No vehicle noises are being produced. The vehicle may not be heard by other road users. <ul style="list-style-type: none"> ► Drive with particular care. ► Consult a qualified specialist workshop.
 <p data-bbox="194 725 462 745">Charger Cable Connected</p>	<ul style="list-style-type: none"> * You cannot pull away while the charging cable is connected. <ul style="list-style-type: none"> ► Disconnect the charging cable from the vehicle.
<p data-bbox="194 771 462 844">Not Possible to Unlock Charging Cable See Operator's Manual</p>	<ul style="list-style-type: none"> * The charging cable connector cannot be removed from the vehicle socket. <ul style="list-style-type: none"> ► If the charging cable is under strain, relieve the strain on the charging cable connector by carefully pulling on the charging cable.

Display messages	Possible causes/consequences and ► Solutions
	<ul style="list-style-type: none"> ► Press the charging interruption button (→ page 215). <p>If the charging cable connector cannot be removed after that:</p> <ul style="list-style-type: none"> ► Consult a qualified specialist workshop.
<p>Vehicle Currently Not Charging... Charging Station Fault</p>	<p>* A malfunction has occurred in the charging station or the RFID card is not recognized.</p> <ul style="list-style-type: none"> ► Start the charging process at a different charging station. <p>or</p> <ul style="list-style-type: none"> ► Use an alternative authentication method or payment method.
<p>Charging Fault Change Charging Mode See Operator's Manual</p>	<p>* A temporary malfunction has occurred in the charging station.</p> <ul style="list-style-type: none"> ► Wait until the malfunction has passed. <p>or</p> <ul style="list-style-type: none"> ► Start the charging process at a different charging station. <p>or</p> <ul style="list-style-type: none"> ► Use an alternative authentication method or payment method.
<p>AC Charging Inoperative Service Required</p>	<p>* The charging process cannot be started due to a malfunction.</p> <ul style="list-style-type: none"> ► Consult a qualified specialist workshop.
<p>DC Charging Inoperative Service Required</p>	<p>* The charging process cannot be started due to a malfunction.</p> <ul style="list-style-type: none"> ► Consult a qualified specialist workshop.

Display messages	Possible causes/consequences and ► Solutions
<p>Authentication Failed Use Different Authentication Method or Charging Station</p>	<ul style="list-style-type: none"> * Plug-and-Charge is not expected to be available at this charging station. <ul style="list-style-type: none"> ► Use an alternative authentication method or payment method. or ► Start the charging process at a different charging station.
<p>Only Electric Drive Available Power Limited</p>	<ul style="list-style-type: none"> * The fuel tank is empty and the combustion engine is switched off. The output of your vehicle is limited because you are driving in electric mode. <ul style="list-style-type: none"> ► Refuel immediately. <p>Subsequently, there may be temporary restrictions in the availability of electric mode over a distance of 31 mi (50 km).</p> <p>If there is fuel in the vehicle, there is a fault with the combustion engine.</p> <ul style="list-style-type: none"> ► Consult a qualified specialist workshop.
<p>"Electric" Drive Program Currently Unavailable</p>	<ul style="list-style-type: none"> * The state of charge of the high-voltage battery or the environmental conditions are not sufficient for the Electric drive program. <ul style="list-style-type: none"> ► Drive on and observe the notes on plug-in hybrid operation (→ page 172). or ► Charge the high-voltage battery (→ page 204).



Display messages	Possible causes/consequences and ► Solutions
<p>Reduced Drive System Performance See Operator's Manual</p>	<ul style="list-style-type: none"> * The drive system switches to emergency operation mode due to a malfunction. <ul style="list-style-type: none"> ► Drive on carefully. ► Consult a qualified specialist workshop.
<p>Preparing Drive System...</p>	<ul style="list-style-type: none"> * The insulation of the drive system is being tested. This process can last for up to ten seconds.
<div data-bbox="155 410 312 493" data-label="Image"> </div> <p>Battery Overheated Stop! Everyone Get Out! Outdoors if Possible</p>	<ul style="list-style-type: none"> * Plug-in hybrid: The high-voltage battery is overheated. There is a risk of fire. <ul style="list-style-type: none"> ► Stop the vehicle immediately in accordance with the traffic conditions. ► If possible, stop the vehicle in the open air and ensure that all vehicle occupants get out. ⓘ Supporting vehicle functions may activate automatically, e.g. air-recirculation mode as part of climate control. ► Do not continue driving. ► If smoke is present, leave the danger zone and call the fire service immediately. ► Consult a qualified specialist workshop even if there are no external signs of a fire.
<div data-bbox="155 667 312 750" data-label="Image"> </div> <p>Malfunction</p>	<ul style="list-style-type: none"> * The drive system is malfunctioning. A warning tone also sounds. <ul style="list-style-type: none"> ► Consult a qualified specialist workshop.

Display messages	Possible causes/consequences and ► Solutions
 <p data-bbox="195 339 399 391">Malfunction Service Required</p>	<ul style="list-style-type: none"> <li data-bbox="519 249 962 308">* The drive system is malfunctioning. <ul style="list-style-type: none"> <li data-bbox="543 280 962 308">► Consult a qualified specialist workshop.
 <p data-bbox="195 510 463 583">Have High-Voltage System Checked See Operator's Manual</p>	<ul style="list-style-type: none"> <li data-bbox="519 420 1079 479">* A function restriction has occurred in the drive system. <ul style="list-style-type: none"> <li data-bbox="543 451 962 479">► Consult a qualified specialist workshop.
<p data-bbox="195 614 469 686">Service Required Do Not Change Transmission Position</p>	<ul style="list-style-type: none"> <li data-bbox="519 614 1692 767">* The transmission is malfunctioning. It is no longer possible to change the transmission position. <ul style="list-style-type: none"> <li data-bbox="543 645 1692 697">► If transmission position D is selected, consult a qualified specialist workshop and do not change the transmission position. <li data-bbox="543 707 1156 735">► For all other transmission positions, park the vehicle safely. <li data-bbox="543 745 1179 767">► Consult a qualified specialist workshop or breakdown service.
<p data-bbox="195 785 426 837">Do Not Restart Vehicle Service Required</p>	<ul style="list-style-type: none"> <li data-bbox="519 785 1434 845">* It is not possible to restart the drive system due to a malfunction. <ul style="list-style-type: none"> <li data-bbox="543 816 1434 845">► Do not switch off the drive system; drive on to the nearest qualified specialist workshop.

Display messages	Possible causes/consequences and ► Solutions
 <p data-bbox="144 342 393 415">Drive Power and Range Reduced See Operator's Manual</p>	<p data-bbox="473 249 1031 275">* A malfunction has occurred in the high-voltage battery.</p> <p data-bbox="495 283 925 309">Output and range will be severely restricted.</p> <ul style="list-style-type: none"> <li data-bbox="495 318 851 343">► Switch the vehicle off and lock it. <li data-bbox="495 352 1175 378">► After waiting for a short time, unlock the vehicle and start it again. <p data-bbox="495 405 861 430">If the display message appears again:</p> <ul style="list-style-type: none"> <li data-bbox="495 439 704 465">► Drive on carefully. <li data-bbox="495 473 1036 499">► Fully charge the high-voltage battery (→ page 204). <p data-bbox="495 526 1300 552">If the output and range are still reduced, there is a malfunction in the drive system.</p> <ul style="list-style-type: none"> <li data-bbox="495 560 704 586">► Drive on carefully. <li data-bbox="495 594 912 620">► Consult a qualified specialist workshop.
<p data-bbox="144 632 399 684">Cannot Start Vehicle See Operator's Manual</p>	<p data-bbox="473 632 851 658">* It is not possible to start the vehicle.</p> <p data-bbox="495 667 959 693">A malfunction has occurred in the drive system.</p> <ul style="list-style-type: none"> <li data-bbox="495 701 851 727">► Switch the vehicle off and lock it. <li data-bbox="495 735 1175 761">► After waiting for a short time, unlock the vehicle and start it again. <li data-bbox="495 769 1578 795">► If the display message appears again and the vehicle does not start, consult a qualified specialist workshop.

Display messages	Possible causes/consequences and ► Solutions
<p>Drive Malfunction Achievable Speed Limited Stop Soon</p>	<p>* The drive system is malfunctioning. The maximum vehicle speed is restricted. The drive system will shut off within a few kilometers.</p> <ul style="list-style-type: none"> ► Stop the vehicle immediately in accordance with the traffic conditions and switch off the drive system. Do not continue driving. ► Do not tow the vehicle; stop towing if necessary. ► Consult a qualified specialist workshop.
<p>Drive Malfunction Achievable Speed Severely Limited See Operator's Manual</p>	<p>* The drive system is malfunctioning. The maximum vehicle speed is restricted.</p> <ul style="list-style-type: none"> ► Consult a qualified specialist workshop.
<div data-bbox="205 565 362 648" data-label="Image"> </div> <p>Malfunction</p>	<p>* The drive system is malfunctioning. The output of your vehicle is restricted.</p> <ul style="list-style-type: none"> ► Consult a qualified specialist workshop.
<div data-bbox="205 708 362 791" data-label="Image"> </div> <p>Stop Switch Off Vehicle</p>	<p>* The drive system is malfunctioning.</p> <ul style="list-style-type: none"> ► Stop the vehicle immediately in accordance with the traffic conditions and switch off the drive system. Do not continue driving. ► Do not tow the vehicle; stop towing if necessary. ► Consult a qualified specialist workshop.

Display messages	Possible causes/consequences and ► Solutions
 <p data-bbox="145 339 380 391">Performance Extremely Limited</p>	<ul style="list-style-type: none"> <li data-bbox="476 249 1646 332">* The drive system is outside the normal operating temperature range, e.g. due to extremely low or high outside temperatures. Output will be severely restricted. Once the operating temperature of the drive system returns to normal, the full output will be available again. The display message will disappear. <li data-bbox="476 405 1304 498">* If the drive system power output is still reduced, there is a fault in the drive system. <ul style="list-style-type: none"> <li data-bbox="495 436 704 464">► Drive on carefully. <li data-bbox="495 472 916 498">► Consult a qualified specialist workshop.
<p data-bbox="145 515 417 622">High-Voltage Battery Fault No Start in Approx. XXX mi Service Required (yellow display message)</p>	<ul style="list-style-type: none"> <li data-bbox="476 515 1541 643">* A malfunction has occurred in the high-voltage battery. It will no longer be possible to start the electric drive system after the distance displayed has been covered. It will still be possible to start the combustion engine. <ul style="list-style-type: none"> <li data-bbox="495 617 1622 643">► Have the necessary maintenance work on the high-voltage battery carried out at a qualified specialist workshop.
<p data-bbox="145 660 417 764">High-Voltage Battery Fault No Start in Approx. XXX mi Service Required (red display message)</p>	<ul style="list-style-type: none"> <li data-bbox="476 660 1641 809">* A malfunction has occurred in the high-voltage battery. It will no longer be possible to start the electric drive system after the distance displayed has been covered. It will still be possible to start the combustion engine. <ul style="list-style-type: none"> <li data-bbox="495 762 1641 809">► Have the necessary maintenance work on the high-voltage battery carried out immediately at a qualified specialist workshop.

Display messages	Possible causes/consequences and ► Solutions
<p>High-Voltage Battery Fault Do Not Restart Service Required</p>	<ul style="list-style-type: none"> * A malfunction has occurred in the high-voltage battery. It will no longer be possible to restart the drive system once it has been switched off. ► Do not switch off the drive system; drive on to the nearest qualified specialist workshop.
<div style="border: 1px solid black; padding: 5px; text-align: center;">  </div> <p>Please Wait Depressurizing Fuel Tank</p>	<ul style="list-style-type: none"> * Vehicles with gasoline engines: the pressure in the fuel tank needs to be reduced before the fuel filler flap is opened. This pressure reduction can take up to 15 minutes.
<div style="border: 1px solid black; padding: 5px; text-align: center;">  </div> <p>Fuel Tank Is Depressurized Ready for Refueling</p>	<ul style="list-style-type: none"> * Vehicles with gasoline engines: the pressure in the fuel tank is released and the fuel filler flap opens.



Vehicle



Display messages	Possible causes/consequences and ► Solutions
	<p>* The driver display is inoperative due to a failed software update. The display message will be shown every time the engine is started.</p> <div style="border: 1px solid gray; padding: 5px; margin: 10px 0;"> <p>⚠ WARNING Risk of accident if the driver's display fails</p> <p>If the driver's display fails or malfunctions, you may not be aware of any functional limitations to safety-critical systems. This may affect the operating safety of the vehicle.</p> <p>► Park the vehicle safely as soon as possible and notify a qualified specialist workshop.</p> </div> <p>If the operating safety of your vehicle is impaired, park the vehicle immediately and safely. Contact a qualified specialist workshop.</p> <p>If the driver display fails, you may not recognize e.g. function restrictions affecting systems relevant to safety or the speed display. The operating safety of the vehicle may be impaired (→ page 320).</p> <p>► Have the vehicle checked by a qualified specialist workshop immediately.</p>
<p>Cannot Start Vehicle See Operator's Manual</p>	<p>* The vehicle cannot be started.</p> <ul style="list-style-type: none"> ► Switch the vehicle off and then back on ► If the display message still appears, consult a qualified specialist workshop. <p>* Vehicles with 48 V on-board electrical system: the state of charge of the 48 V battery is too low. You can no longer start the vehicle.</p> <ul style="list-style-type: none"> ► Switch off electrical consumers that are not required.



Display messages	Possible causes/consequences and ► Solutions
	<ul style="list-style-type: none"> ► Connect a suitable charger approved for Mercedes-Benz with sufficient charge output to the jump-start connection point of the 12 V battery (→ page 394). The 48 V battery is charged via the voltage converter in the vehicle.
<p>Vehicle Ready to Drive Shutdown Occurs When Locked or Automatically in XX Mins</p>	<ul style="list-style-type: none"> * You are about to leave the vehicle and the engine is running. The vehicle will switch off automatically in 20 minutes. <ul style="list-style-type: none"> ► To prevent the vehicle from switching off automatically, acknowledge the message on the central display of the multimedia system. * You are in the vehicle. Park position P is engaged and the engine is running. After a certain holding time, this display message will appear on the driver display. The vehicle will then switch off automatically after a total of 20 minutes of holding time. <ul style="list-style-type: none"> ► To prevent the vehicle from switching off automatically, acknowledge the message on the central display of the multimedia system.
<p>Vehicle Ready to Drive Shutdown Occurs When Locked or After a Few Minutes</p>	<ul style="list-style-type: none"> * You are leaving the vehicle in a ready-to-drive state. <ul style="list-style-type: none"> ► Get out of the vehicle, secure it against rolling away and take the key with you. ► If you do not leave the vehicle, switch off the electrical consumers, e.g. the seat heating. Otherwise, the 12 V battery may discharge and starting the engine may be possible only with the help of a second battery (jump start).

Display messages	Possible causes/consequences and ► Solutions
 <p data-bbox="144 342 323 365">Add Washer Fluid</p>	<p data-bbox="469 249 1308 272">* The washer fluid level in the washer fluid reservoir has dropped below the minimum.</p> <ul style="list-style-type: none"> <li data-bbox="493 280 842 308">► Add washer fluid (→ page 369).
<p data-bbox="144 391 415 439">Windshield Wiper Malfunction</p>	<p data-bbox="469 391 875 414">* The windshield wiper is malfunctioning.</p> <ul style="list-style-type: none"> <li data-bbox="493 422 718 450">► Restart the vehicle. <p data-bbox="493 474 842 502">If the display message still appears:</p> <ul style="list-style-type: none"> <li data-bbox="493 510 912 538">► Consult a qualified specialist workshop.
<p data-bbox="144 553 421 625">Head-up Display Currently Unavailable See Operator's Manual</p>	<p data-bbox="469 553 1116 576">* The head-up display is temporarily unavailable. Possible causes:</p> <ul style="list-style-type: none"> <li data-bbox="500 584 851 612">• Malfunctions in the power supply <li data-bbox="500 620 713 648">• Signal interference <ul style="list-style-type: none"> <li data-bbox="493 656 1363 684">► Stop in accordance with the traffic conditions and switch the vehicle off and on again. <li data-bbox="493 693 1262 721">► If the display message still appears, consult a qualified specialist workshop.
<p data-bbox="144 739 402 787">Head-up Display Inoperative</p>	<p data-bbox="469 739 898 762">* The head-up display has an internal error.</p> <ul style="list-style-type: none"> <li data-bbox="493 770 912 798">► Consult a qualified specialist workshop.

Display messages	Possible causes/consequences and ► Solutions
<p data-bbox="194 249 439 325">Head-up Display Brightness Currently Reduced See Operator's Manual</p>	<p data-bbox="519 249 1191 272">* The brightness of the head-up display is reduced. Possible causes:</p> <ul data-bbox="550 285 1086 344" style="list-style-type: none"> <li data-bbox="550 285 1086 308">• Dirt on the windshield in the camera's field of vision <li data-bbox="550 319 901 344">• Faulty exterior brightness signals <p data-bbox="541 360 888 386">► Switch on the windshield wiper.</p> <p data-bbox="541 396 911 422">► Clean the windshield if necessary.</p> <p data-bbox="541 433 966 458">► Switch the vehicle off and then back on</p> <p data-bbox="541 469 1313 495">► If the display message still appears, consult a qualified specialist workshop.</p>
<div data-bbox="205 508 362 588" style="border: 1px solid black; padding: 5px; text-align: center;">  </div> <p data-bbox="194 601 458 677">Steering Malfunction Stop Immediately See Operator's Manual</p>	<p data-bbox="519 508 1271 534">* The steering is malfunctioning. Steering capability is significantly impaired.</p> <div data-bbox="550 547 1696 588" style="background-color: #f0f0f0; padding: 5px;"> <p data-bbox="559 560 1179 586">⚠ WARNING Risk of accident if steering capability is impaired</p> </div> <p data-bbox="559 598 1437 624">If the steering does not function as intended, the vehicle's operating safety is jeopardized.</p> <ul data-bbox="559 635 1641 717" style="list-style-type: none"> <li data-bbox="559 635 1641 686">► Pull over and stop the vehicle safely as soon as possible, paying attention to road and traffic conditions. Do not continue driving under any circumstances. <li data-bbox="559 697 984 717">► Consult a qualified specialist workshop.

Display messages	Possible causes/consequences and ► Solutions
 <p>Steering Malfunction Increased Physical Effort See Operator's Manual</p>	<p>* The power steering assistance is malfunctioning.</p> <div style="border: 1px solid black; padding: 5px; margin: 10px 0;"> <p>▲ WARNING Risk of an accident due to altered steering characteristics</p> <p>If the power assistance of the steering fails partially or completely, you will need to use more force to steer.</p> <ul style="list-style-type: none"> ▶ If safe steering is possible, drive on carefully. ▶ Visit or consult a qualified specialist workshop immediately. </div>
 <p>Steering Malfunction Drive Carefully Service Required</p>	<p>* A power steering malfunction has occurred. Steering characteristics may be impaired as a result.</p> <ul style="list-style-type: none"> ▶ Drive on carefully. ▶ Consult a qualified specialist workshop.
 <p>Rear Axle Steering Currently Malfunctioning</p>	<p>* The rear-axle steering is temporarily unavailable. The turning circle may become wider.</p> <ul style="list-style-type: none"> ▶ Stop the vehicle in accordance with the traffic conditions and restart the vehicle. <p>If the display message does not disappear:</p> <ul style="list-style-type: none"> ▶ Drive on carefully. ▶ Consult a qualified specialist workshop.



Display messages	Possible causes/consequences and ► Solutions
 <p data-bbox="194 341 480 393">Rear Axle Steering Malfunction Service Required</p>	<ul style="list-style-type: none"> * The rear-axle steering is malfunctioning. The rear axle has no steering capability. The steering wheel may be at an angle when you drive in a straight line. <ul style="list-style-type: none"> ► Adapt your speed and drive on carefully. ► Consult a qualified specialist workshop immediately.
 <p data-bbox="194 518 480 569">Rear Axle Steering Malfunction Stop Immediately</p>	<ul style="list-style-type: none"> * The rear-axle steering is malfunctioning. The rear axle has no steering capability. The steering wheel may be at an angle when you drive in a straight line. <div style="border: 1px solid black; padding: 5px; margin-top: 10px;"> <p>⚠ WARNING Risk of accident if steering capability is impaired</p> <p>If the steering does not function as intended, the vehicle's operating safety is jeopardized.</p> <ul style="list-style-type: none"> ► Pull over and stop the vehicle safely as soon as possible, paying attention to road and traffic conditions. Do not continue driving under any circumstances. ► Consult a qualified specialist workshop. </div>
<p data-bbox="194 730 462 782">Ambient Lighting Warning Support Inoperative</p>	<ul style="list-style-type: none"> * The ambient lighting may not provide full visual warning support. <ul style="list-style-type: none"> ► Lock the vehicle and unlock it again after a few minutes. ► If the display message appears regularly, contact a qualified specialist workshop.

Display messages	Possible causes/consequences and ► Solutions
	<p>* The hood is open.</p> <p>▲ WARNING Risk of accident due to driving with the hood unlocked</p> <p>The hood may open and block your view.</p> <ul style="list-style-type: none">▶ Never release the hood when driving.▶ Before every trip, ensure that the hood is locked. <p>► Stop the vehicle immediately in accordance with the traffic conditions.</p> <p>► Close the hood.</p>
	<p>* At least one door is open.</p> <p>► Close all doors.</p>
	<p>* The trunk lid is open.</p> <p>▲ DANGER Risk of exhaust gas poisoning</p> <p>Combustion engines emit poisonous exhaust gases such as carbon monoxide. Exhaust gases can enter the vehicle interior if the trunk lid is open when the engine is running, especially if the vehicle is in motion.</p> <ul style="list-style-type: none">▶ Always switch off the engine before opening the trunk lid.▶ Never drive with the trunk lid open.

Display messages	Possible causes/consequences and ► Solutions
	<ul style="list-style-type: none"> ► Close the trunk lid.
Function Blocked by Folded Center Backrest	<ul style="list-style-type: none"> * You cannot electrically unlock the left seat backrest. ► Fold the center seat backrest back until it engages.
 <p>Rear Left Backrest Not Latched (example)</p>	<ul style="list-style-type: none"> * The seat backrest of the corresponding seat is not engaged. ► Fold the seat backrest back until it engages.

Engine

Display messages	Possible causes/consequences and ► Solutions
To Switch Off Vehicle Press and Hold Start/Stop Button for at Least 3 Seconds or Press 3 Times	<ul style="list-style-type: none"> * You have pressed the start/stop button while the vehicle is in motion. ► Information about switching off the vehicle while it is being driven (→ page 176).

Display messages	Possible causes/consequences and ► Solutions
 <p data-bbox="144 339 399 391">Check Coolant Level See Operator's Manual</p>	<p data-bbox="476 249 765 270">* The coolant level is too low.</p> <div data-bbox="500 291 1646 377" style="border: 1px solid black; padding: 5px;"> <p data-bbox="506 301 1027 325">! NOTE Engine damage due to insufficient coolant</p> <p data-bbox="506 339 983 363">► Avoid long journeys with insufficient coolant.</p> </div> <p data-bbox="493 391 802 415">► Add coolant (→ page 369).</p> <p data-bbox="493 428 1262 452">► Have the engine cooling system checked at a qualified specialist workshop.</p>
 <p data-bbox="144 560 389 612">Coolant Stop Switch Off Vehicle</p>	<p data-bbox="476 470 713 491">* The coolant is too hot.</p> <p data-bbox="493 504 1356 528">► Stop immediately in accordance with the traffic conditions and switch off the vehicle.</p> <div data-bbox="500 553 1646 815" style="border: 1px solid black; padding: 5px;"> <p data-bbox="506 563 1023 587">▲ WARNING Risk of burns when opening the hood</p> <p data-bbox="506 605 1604 656">If you open the hood in the event of an overheated engine or fire in the engine compartment, the following situations may occur:</p> <ul data-bbox="506 670 1212 729" style="list-style-type: none"> <li data-bbox="506 670 968 694">• You may come into contact with hot gases. <li data-bbox="506 704 1212 729">• You may come into contact with other escaping hot operating fluids. <p data-bbox="506 742 1097 766">► Before opening the hood, allow the engine to cool down.</p> <p data-bbox="506 777 1474 800">► In the event of a fire in the engine compartment, keep the hood closed and call the fire service.</p> </div> <p data-bbox="493 832 907 856">► Wait until the engine has cooled down.</p>

Display messages	Possible causes/consequences and ► Solutions
	<ul style="list-style-type: none"> ► Make sure that the air supply to the radiator is not obstructed. ► Avoiding high loads on the engine, drive to the nearest qualified specialist workshop. In doing so, ensure that the coolant temperature display remains below the red marking.
Fuel Reserve	<ul style="list-style-type: none"> * The fuel supply has dropped into the reserve range. <ul style="list-style-type: none"> ► Refuel.
 Fuel Filler Cap Open	<ul style="list-style-type: none"> * The fuel filler cap is not closed correctly or the fuel system is leaking. <ul style="list-style-type: none"> ► Close the fuel filler cap. ► If the fuel filler cap was already properly closed: consult a qualified specialist workshop.

Transmission

Display messages	Possible causes/consequences and ► Solutions
Shift to P Only When Vehicle Is Stationary	<ul style="list-style-type: none"> * It is possible to select the park position P only if the vehicle is stationary. <ul style="list-style-type: none"> ► Depress the brake pedal to stop. ► Shift the transmission to park position P when the vehicle is stationary.
Depress Brake to Shift from P	<ul style="list-style-type: none"> * You have attempted to shift the transmission out of park position P and into another transmission position. <ul style="list-style-type: none"> ► Depress the brake pedal.

Display messages	Possible causes/consequences and ► Solutions
<p>To Deselect P or N Depress Brake and Start Vehicle</p>	<p>► Select transmission position D, R or neutral N.</p> <p>* You have attempted to shift the transmission out of park position P or neutral N and into another transmission position.</p> <p>► Depress the brake pedal.</p> <p>► Start the vehicle.</p> <p>► Change the transmission position.</p>
<p>Depress Brake to Shift to D or R</p>	<p>* You have attempted to select transmission position D or R.</p> <p>► Depress the brake pedal.</p> <p>► Select transmission position D or R.</p>
<p>Depress Brake to Shift to R</p>	<p>* You have attempted to select transmission position R.</p> <p>► Depress the brake pedal.</p> <p>► Select transmission position R.</p>
<p>Service Required Apply Parking Brake to Park</p>	<p>* A malfunction has occurred in the emergency power supply to park position P.</p> <p>► Consult a qualified specialist workshop.</p> <p>► Until then, always select park position P manually before you switch off the vehicle.</p> <p>► Before leaving the vehicle, apply the electric parking brake.</p>





Display messages	Possible causes/consequences and ► Solutions
<p>Risk of Vehicle Rolling Away Driver's Door Open Position P Not Selected</p>	<p>* The driver's door is not fully closed and transmission position D, R or neutral N is selected. The vehicle may roll away.</p> <ul style="list-style-type: none"> ► Select park position P when switching off the vehicle.
<p>Risk of Vehicle Rolling Away Apply Parking Brake When Parking</p>	<p>* The transmission is malfunctioning. Park position P cannot be selected.</p> <ul style="list-style-type: none"> ► Park the vehicle safely. ► Use the electric parking brake to secure the vehicle against rolling away. ► On gradients, turn the front wheels so that the vehicle will roll towards the curb if it starts moving.
<p>Risk of Vehicle Rolling Away N Activated Manually No Automatic Change to P</p>	<p>* While the vehicle was at a standstill or driving at very low speed, neutral N was engaged with the engine running or the vehicle switched on.</p> <div style="border: 1px solid black; padding: 5px; margin: 10px 0;"> <p>! NOTE Damage to the vehicle due to rolling away</p> <p>When the vehicle is switched off or the driver's door is opened, automatic engagement of park position P is deactivated. The vehicle may roll away.</p> <ul style="list-style-type: none"> ► Be ready to brake. ► Do not leave the vehicle unattended. </div> <ul style="list-style-type: none"> ► Depress the brake pedal until the vehicle comes to a standstill. ► Engage park position P when the vehicle is stationary with the brake pedal depressed.









Display messages	Possible causes/consequences and ► Solutions
<p>N Automatically Activated Please Shift to Transmission Position Again</p>	<ul style="list-style-type: none"> ► To continue driving with the brake pedal depressed, select transmission position D or R. * Neutral N was automatically engaged when the vehicle was rolling or being driven. <ul style="list-style-type: none"> ⓘ When you open the driver's door in neutral N, park position P will be engaged automatically. ► Engage park position P when the vehicle is stationary with the brake pedal depressed. ► To continue driving with the brake pedal depressed, select transmission position D or R.
<p>To shift to N, hold selector lever longer in N position</p>	<ul style="list-style-type: none"> * Selector lever not held for long enough in position N. It will be possible to change from park position P to neutral N only if the selector lever is held in N for an extended period of time. If the selector lever is not held for long enough, park position P will remain engaged. <ul style="list-style-type: none"> ► When changing from park position P to neutral N, hold the selector lever in position N for an extended period of time.
<p>Reversing Not Possible Service Required</p>	<ul style="list-style-type: none"> * The transmission is malfunctioning. It is not possible to select transmission position R. <ul style="list-style-type: none"> ► Consult a qualified specialist workshop.
<p>Transmission Malfunction Stop</p>	<ul style="list-style-type: none"> * The transmission is malfunctioning. The transmission shifts to neutral N automatically. <ul style="list-style-type: none"> ► Stop the vehicle immediately in accordance with the traffic conditions. ► Depress the brake pedal. ► Engage park position P. ► Consult a qualified specialist workshop.

Display messages	Possible causes/consequences and ► Solutions
<p>Service Required Do Not Change Transmission Position</p>	<ul style="list-style-type: none"> * The transmission is malfunctioning. It is no longer possible to change the transmission position. <ul style="list-style-type: none"> ► If transmission position D is selected, consult a qualified specialist workshop and do not change the transmission position. ► For all other transmission positions, park the vehicle safely. ► Consult a qualified specialist workshop or breakdown service.
<p>Drive Malfunction Stop Restart Vehicle</p>	<ul style="list-style-type: none"> * The transmission is malfunctioning. <ul style="list-style-type: none"> ► Stop the vehicle immediately in accordance with the traffic conditions. ► Restart the vehicle. <p>If the display message still appears:</p> <ul style="list-style-type: none"> ► Consult a qualified specialist workshop.
<p>Drive Malfunction Stop Contact Dealer</p>	<ul style="list-style-type: none"> * The transmission is malfunctioning. <ul style="list-style-type: none"> ► Stop the vehicle immediately in a safe location and do not continue driving. ► Consult a qualified specialist workshop.
<p>Drive Overheated Drive Carefully</p>	<ul style="list-style-type: none"> * The transmission is overheating. When the display message is active, start-up and driving characteristics may be temporarily impaired. <ul style="list-style-type: none"> ► Drive at low engine speed. ► Avoid sporty driving. ► Before pulling away on uphill gradients, let the transmission cool down until the display message disappears.









Display messages	Possible causes/consequences and ► Solutions
Auxiliary Battery Malfunction (white display message)	<ul style="list-style-type: none">* There is a malfunction in the auxiliary battery.<ul style="list-style-type: none">► Consult a qualified specialist workshop.► Until then, always select park position P manually before you switch off the vehicle.► Before leaving the vehicle, apply the electric parking brake.
Auxiliary Battery Malfunction (red display message)	<ul style="list-style-type: none">* There is a malfunction in the auxiliary battery.<ul style="list-style-type: none">► Consult a qualified specialist workshop.► Until then, always select park position P manually before you switch off the vehicle.► Before leaving the vehicle, apply the electric parking brake.





Brakes

Display messages	Possible causes/consequences and ► Solutions
<div data-bbox="203 295 360 378" data-label="Image"> </div> <p data-bbox="203 383 304 409">(USA only)</p> <div data-bbox="203 419 360 502" data-label="Image"> </div> <p data-bbox="203 507 341 533">(Canada only)</p> <p data-bbox="194 543 462 595">Parking Brake See Operator's Manual</p>	<ul style="list-style-type: none"> <li data-bbox="526 290 1339 315">* The yellow  indicator lamp is lit. The electric parking brake is malfunctioning. <ul style="list-style-type: none"> <li data-bbox="545 326 637 352">To apply: <li data-bbox="545 357 970 383">► Switch the vehicle off and then back on <li data-bbox="545 388 1136 419">► Apply the electric parking brake manually (→ page 226). <li data-bbox="545 445 1071 471">If it is not possible to apply the electric parking brake: <ul style="list-style-type: none"> <li data-bbox="545 476 970 502">► Consult a qualified specialist workshop. <li data-bbox="545 507 1256 538">► Where necessary, also secure the parked vehicle against rolling away. <li data-bbox="526 549 1690 600">* The yellow  indicator lamp and the red  (USA only) or  (Canada only) indicator lamp are lit. The electric parking brake is malfunctioning. <ul style="list-style-type: none"> <li data-bbox="545 611 656 637">To release: <li data-bbox="545 642 970 668">► Switch the vehicle off and then back on <li data-bbox="545 673 1155 704">► Release the electric parking brake manually (→ page 226). <li data-bbox="545 714 572 740">or <li data-bbox="545 745 1201 777">► Release the electric parking brake automatically (→ page 226). <li data-bbox="545 777 1127 802">If it is still not possible to release the electric parking brake: <ul style="list-style-type: none"> <li data-bbox="545 808 1210 839">► Do not continue driving. Consult a qualified specialist workshop.

Display messages	Possible causes/consequences and ► Solutions
	<p>* The yellow  indicator lamp is lit and the red  (USA only) or  (Canada only) indicator lamp is flashing. The electric parking brake is malfunctioning.</p> <p>The electric parking brake could not be applied or released.</p> <ul style="list-style-type: none">► Switch the vehicle off and then back on <p>To apply:</p> <ul style="list-style-type: none">► Release and then apply the electric parking brake manually (→ page 226). <p>To release:</p> <ul style="list-style-type: none">► Apply and then release the electric parking brake manually. <p>If the electric parking brake cannot be applied or the red  (USA only) or  (Canada only) indicator lamp continues to flash:</p> <ul style="list-style-type: none">► Do not continue driving. Consult a qualified specialist workshop.► Where necessary, also secure the parked vehicle against rolling away. <p>* The yellow  indicator lamp is lit and the red  indicator lamp (USA only) or  indicator lamp (Canada only) flashes for approximately ten seconds after the electric parking brake has been applied or released. It then remains lit or goes out. The electric parking brake is malfunctioning.</p> <p>If the state of charge is too low:</p> <ul style="list-style-type: none">► Charge the 12 V battery (→ page 394).

Display messages	Possible causes/consequences and ► Solutions
	<p>To apply:</p> <ul style="list-style-type: none">► Apply the electric parking brake manually. <p>If it is not possible to apply the electric parking brake:</p> <ul style="list-style-type: none">► Consult a qualified specialist workshop.► Where necessary, also secure the parked vehicle against rolling away. <p>To release:</p> <ul style="list-style-type: none">► If the conditions for automatic release are fulfilled and the electric parking brake is not released automatically, release the electric parking brake manually (→ page 226). <p>If it is still not possible to release the electric parking brake:</p> <ul style="list-style-type: none">► Do not continue driving. Consult a qualified specialist workshop.

Display messages	Possible causes/consequences and ► Solutions
 <p>(USA only)</p>  <p>(Canada only)</p> <p>Release Parking Brake</p>	<p>* The red  indicator lamp (USA only) or  indicator lamp (Canada only) is flashing.</p> <p>The electric parking brake is applied while you are driving:</p> <ul style="list-style-type: none">• A condition for automatic release of the electric parking brake has not been fulfilled (→ page 226).• You are performing emergency braking using the electric parking brake (→ page 226). <p>► Check the conditions for automatic release of the electric parking brake.</p> <p>► Release the electric parking brake manually.</p>
 <p>(USA only)</p>  <p>(Canada only)</p> <p>Switch on Vehicle to Release the Parking Brake</p>	<p>* The red  (USA only) or  (Canada only) indicator lamp is lit.</p> <p>You have attempted to release the electric parking brake with the vehicle switched off.</p> <p>► Switch on the vehicle.</p>



Display messages	Possible causes/consequences and ► Solutions
 <p>(USA only)</p>  <p>(Canada only)</p> <p>Brake Immediately</p>	<p>* A malfunction has occurred while the HOLD function was activated. A horn may also sound at regular intervals. You cannot start the vehicle system.</p> <p>► Immediately depress the brake pedal firmly until the display message disappears. You cannot start the vehicle system again.</p>
 <p>(USA only)</p>  <p>(Canada only)</p> <p>Malfunction See Operator's Manual</p>	<p>* The brake force boosting function is impaired. The hill start assist may be impaired.</p> <p>⚠ WARNING Risk of an accident due to a brake system malfunction</p> <p>If the brake system is malfunctioning, braking characteristics may be impaired.</p> <ul style="list-style-type: none"> ► Drive on carefully. ► Have the brake system checked immediately at a qualified specialist workshop.

Display messages	Possible causes/consequences and ► Solutions
<div data-bbox="155 252 312 332" data-label="Image"> </div> <p data-bbox="145 342 247 366">(USA only)</p> <div data-bbox="155 379 312 458" data-label="Image"> </div> <p data-bbox="145 469 279 493">(Canada only)</p> <p data-bbox="145 503 319 527">Malfunction Stop</p>	<p data-bbox="476 249 1411 273">* The brake force boosting function is impaired and the braking characteristics may be affected.</p> <div data-bbox="500 291 1648 329" data-label="Text"> <p>▲ WARNING Risk of accident and injury if brake force boosting is malfunctioning</p> </div> <p data-bbox="510 339 1609 389">If brake force boosting is malfunctioning, increased brake pedal force may be necessary for braking. The braking characteristics may be impaired. The braking distance can increase in emergency braking situations.</p> <ul data-bbox="510 399 1134 458" style="list-style-type: none"> ► Stop in a safe location immediately. Do not continue driving. ► Consult a qualified specialist workshop.
<div data-bbox="155 553 312 632" data-label="Image"> </div> <p data-bbox="145 643 247 667">(USA only)</p> <div data-bbox="155 679 312 759" data-label="Image"> </div> <p data-bbox="145 769 279 793">(Canada only)</p> <p data-bbox="145 803 389 827">Check Brake Fluid Level</p>	<p data-bbox="476 556 1058 580">* There is insufficient brake fluid in the brake fluid reservoir.</p> <div data-bbox="500 597 1648 636" data-label="Text"> <p>▲ WARNING Risk of an accident due to low brake fluid level</p> </div> <p data-bbox="510 646 1485 670">If the brake fluid level is too low, the braking effect and the braking characteristics may be impaired.</p> <ul data-bbox="510 680 1591 798" style="list-style-type: none"> ► Pull over and stop the vehicle safely as soon as possible, paying attention to road and traffic conditions. Do not continue driving under any circumstances. ► Consult a qualified specialist workshop. ► Do not add brake fluid.



Display messages	Possible causes/consequences and ► Solutions
<p>Check Brake Pads See Operator's Manual</p>	<p>* The brakepads have reached the wear limit. ► Consult a qualified specialist workshop.</p>

Driving and driving safety systems

Display messages	Possible causes/consequences and ► Solutions
<div data-bbox="205 453 362 536" data-label="Image"> </div> <div data-bbox="205 541 362 624" data-label="Image"> </div> <p data-bbox="195 629 462 681">Currently Unavailable See Operator's Manual</p>	<p>* ABS and ESP[®] are temporarily unavailable. Other driving systems and driving safety systems (e.g. BAS) may also be temporarily unavailable. The brake system will continue to operate normally. Braking distance may increase in an emergency braking situation.</p> <div data-bbox="550 567 1696 612" data-label="Text"> <p>⚠ WARNING Risk of skidding if ABS and ESP[®] are malfunctioning</p> </div> <p data-bbox="561 617 1430 643">The wheels may lock during braking and ESP[®] does not perform any vehicle stabilization.</p> <p data-bbox="561 650 1650 705">The steerability and braking characteristics are heavily impaired and the braking distance may increase. In addition, other driving safety systems are switched off.</p> <ul style="list-style-type: none"> <li data-bbox="561 710 1615 765">► Drive carefully on a suitable stretch of road, making slight steering movements at a speed above 19 mph (30 km/h). <li data-bbox="561 770 1633 825">► If the display message does not disappear, consult a qualified specialist workshop immediately. Drive carefully.

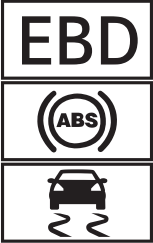

Display messages	Possible causes/consequences and ► Solutions
 <p data-bbox="144 425 417 474">Inoperative See Operator's Manual</p>	<p data-bbox="476 249 1641 346">* ABS and ESP® are malfunctioning. Other driving systems and driving safety systems (e.g. BAS) may also be malfunctioning. The brake system will continue to operate normally. Braking distance may increase in an emergency braking situation.</p> <div data-bbox="500 363 1646 405" style="background-color: #e0e0e0; padding: 5px;"> <p data-bbox="506 370 1166 401">▲ WARNING Risk of skidding if ABS and ESP® are malfunctioning</p> </div> <p data-bbox="513 415 1600 501">The wheels may block during braking and ESP® does not perform any vehicle stabilization. The steerability and braking characteristics are heavily impaired and the braking distance may increase. In addition, other driving safety systems are switched off.</p> <ul data-bbox="513 508 1289 573" style="list-style-type: none"> <li data-bbox="513 508 722 536">► Drive on carefully. <li data-bbox="513 542 1289 573">► Have ABS and ESP® checked immediately at a qualified specialist workshop.
 <p data-bbox="144 692 408 740">Currently Unavailable See Operator's Manual</p>	<p data-bbox="476 598 1350 664">* ESP® is temporarily unavailable. Other driving systems and driving safety systems (e.g. BAS) may also be malfunctioning.</p> <div data-bbox="500 681 1646 723" style="background-color: #e0e0e0; padding: 5px;"> <p data-bbox="506 688 1060 715">▲ WARNING Risk of skidding if ESP is malfunctioning®</p> </div> <p data-bbox="513 733 1618 781">If ESP® is malfunctioning, ESP® cannot carry out vehicle stabilization. In addition, other driving safety systems are switched off.</p> <ul data-bbox="513 788 1563 843" style="list-style-type: none"> <li data-bbox="513 788 1563 843">► Drive carefully on a suitable stretch of road, making slight steering movements at a speed above 19 mph (30 km/h).

Display messages	Possible causes/consequences and ► Solutions
	<ul style="list-style-type: none"> ► If the display message does not disappear, consult a qualified specialist workshop immediately. Drive carefully.
 <p data-bbox="195 426 467 474">Inoperative See Operator's Manual</p>	<p data-bbox="526 336 776 362">* ESP® is malfunctioning.</p> <p data-bbox="545 370 1400 396">Other driving systems and driving safety systems (e.g. BAS) may also be malfunctioning.</p> <p data-bbox="545 405 1690 430">The brake system will continue to operate normally. Braking distance may increase in an emergency braking situation.</p> <div data-bbox="545 450 1700 492" style="background-color: #cccccc; padding: 5px;"> <p data-bbox="558 456 1112 482">▲ WARNING Risk of skidding if ESP® is malfunctioning</p> </div> <p data-bbox="563 498 1672 550">If ESP® is malfunctioning, ESP® cannot carry out vehicle stabilization. In addition, other driving safety systems are switched off.</p> <ul style="list-style-type: none"> ► Drive on carefully. ► Have ESP® checked at a qualified specialist workshop.

Display messages	Possible causes/consequences and ► Solutions
 <p data-bbox="144 511 417 561">Inoperative See Operator's Manual</p>	<p data-bbox="476 250 1349 312">* EBD, ABS and ESP® are malfunctioning. Other driving systems and driving safety systems (e.g. BAS) may also be malfunctioning.</p> <div data-bbox="500 329 1648 547" style="border: 1px solid gray; padding: 5px;"> <p data-bbox="506 337 1219 366">▲ WARNING Risk of skidding if EBD, ABS and ESP® are malfunctioning</p> <p data-bbox="513 381 1389 408">The wheels may block during braking and ESP® does not perform any vehicle stabilization.</p> <p data-bbox="513 416 1600 466">The steerability and braking characteristics are heavily impaired and the braking distance may increase. In addition, other driving safety systems are switched off.</p> <ul style="list-style-type: none"> <li data-bbox="513 476 724 503">► Drive on carefully. <li data-bbox="513 511 1315 538">► Have the brake system checked immediately at a qualified specialist workshop. </div>
 <p data-bbox="144 677 181 702">Off</p>	<p data-bbox="476 589 1541 616">* The HOLD function is deactivated because the vehicle is slipping or a condition for activation is not fulfilled.</p> <ul style="list-style-type: none"> <li data-bbox="495 624 1578 651">► Reactivate the HOLD function later or check the activation conditions for the HOLD function (→ page 234).
 <p data-bbox="144 822 417 872">ATTENTION ASSIST: Take a Break!</p>	<p data-bbox="476 730 1500 780">* ATTENTION ASSIST has detected fatigue or an increasing lack of concentration on the part of the driver (→ page 235).</p> <ul style="list-style-type: none"> <li data-bbox="495 788 787 815">► If necessary, take a break.

Display messages	Possible causes/consequences and ► Solutions
 <p data-bbox="195 342 282 365">--- mph</p>	<ul style="list-style-type: none"> * Cruise control cannot be activated because not all activation conditions are fulfilled. <ul style="list-style-type: none"> ► Observe the activation conditions for cruise control (→ page 237).
<p data-bbox="195 391 463 414">Cruise Control Inoperative</p>	<ul style="list-style-type: none"> * Cruise control is malfunctioning. <ul style="list-style-type: none"> ► Consult a qualified specialist workshop.
<p data-bbox="195 467 380 490">Cruise Control Off</p>	<ul style="list-style-type: none"> * Cruise control has been deactivated. If there is an additional warning tone, cruise control has been deactivated automatically (→ page 237).
<p data-bbox="195 542 426 617">Traffic Sign Assist Currently Unavailable See Operator's Manual</p>	<ul style="list-style-type: none"> * Traffic Sign Assist is temporarily unavailable. Once the cause of the problem is no longer present, the system will be available again. <ul style="list-style-type: none"> ► Continue driving in compliance with the traffic regulations.
<p data-bbox="195 653 469 699">Traffic Sign Assist Inoperative</p>	<ul style="list-style-type: none"> * Traffic Sign Assist is malfunctioning. <ul style="list-style-type: none"> ► Continue driving in compliance with the traffic regulations. or ► Stop the vehicle in accordance with the traffic conditions and restart the vehicle. ► If the display message does not disappear: consult a qualified specialist workshop.

Driver assistance systems

Display messages	Possible causes/consequences and ► Solutions
 <p>--- mph</p>	<p>* Active Distance Assist DISTRONIC cannot be activated because not all activation conditions are fulfilled.</p> <p>► Comply with the activation conditions of Active Distance Assist DISTRONIC (→ page 241).</p>
 <p>Suspended</p>	<p>* If you depress the accelerator pedal beyond the setting of Active Distance Assist DISTRONIC, the system will switch to passive mode (→ page 239).</p>
 <p>Off</p>	<p>* Active Distance Assist DISTRONIC was deactivated. If a warning tone also sounds, Active Distance Assist DISTRONIC has deactivated automatically (→ page 241).</p>
<p>Active Distance Assist Currently Unavailable See Operator's Manual</p>	<p>* Active Distance Assist DISTRONIC is temporarily unavailable. The ambient conditions are outside the system limits (→ page 239). As soon as the ambient conditions are within the system limits, the system will become available again.</p> <p>► Drive on carefully.</p> <p>or</p>

Display messages	Possible causes/consequences and ► Solutions
	<ul style="list-style-type: none"> ► If the display message does not disappear, stop the vehicle in accordance with the traffic conditions and restart the vehicle.
Active Distance Assist Inoperative	<ul style="list-style-type: none"> * Active Distance Assist DISTRONIC is malfunctioning. Other driving systems and driving safety systems may also be malfunctioning. <ul style="list-style-type: none"> ► Drive on carefully. or ► Stop the vehicle in accordance with the traffic conditions and restart the vehicle. ► If the display message does not disappear: consult a qualified specialist workshop.
Active Distance Assist Now Available	<ul style="list-style-type: none"> * Active Distance Assist DISTRONIC is operational again. <ul style="list-style-type: none"> ► Switch on Active Distance Assist DISTRONIC (→ page 241).
Active Brake Assist Functions Currently Limited See Operator's Manual	<ul style="list-style-type: none"> * For vehicles with the Driving Assistance Package, the following functions may be temporarily unavailable or only partially available: <ul style="list-style-type: none"> • Active Brake Assist with cross-traffic function • Evasive Steering Assist • PRE-SAFE® PLUS <p>Vehicles with Blind Spot Assist: PRE-SAFE® PLUS is temporarily unavailable. The ambient conditions are outside the system limits (→ page 255).</p> <p>Vehicles without the Driving Assistance Package: Active Brake Assist is temporarily unavailable.</p>

Display messages	Possible causes/consequences and ► Solutions
	<p>► Drive on carefully. As soon as the ambient conditions are within the system limits, the system will become available again.</p> <p>or</p> <p>► If the display message does not disappear, stop the vehicle in accordance with the traffic conditions and restart the vehicle.</p>
<p>Active Brake Assist Functions Limited See Operator's Manual</p>	<p>* For vehicles with the Driving Assistance Package, the following functions may be temporarily unavailable or only partially available:</p> <ul style="list-style-type: none"> • Active Brake Assist with cross-traffic function • Evasive Steering Assist • PRE-SAFE® PLUS <p>Vehicles without the Driving Assistance Package: Active Brake Assist is temporarily unavailable or only partially available.</p> <p>► Drive on carefully.</p> <p>or</p> <p>► Stop the vehicle in accordance with the traffic conditions and restart the vehicle. ► If the display message does not disappear: consult a qualified specialist workshop.</p>
<p>Active Steering Assist Currently Unavailable See Operator's Manual</p>	<p>* Active Steering Assist is temporarily unavailable. The ambient conditions are outside the system limits (→ page 246). As soon as the ambient conditions are within the system limits, the system will become available again.</p>

Display messages	Possible causes/consequences and ► Solutions
	<ul style="list-style-type: none"> ► Drive on ► Check the tire pressure if necessary.
Active Steering Assist Inoperative	<p>* Active Steering Assist is malfunctioning. Active Distance Assist DISTRONIC remains available.</p> <ul style="list-style-type: none"> ► Drive on <p>or</p> <ul style="list-style-type: none"> ► Stop the vehicle in accordance with the traffic conditions and restart the vehicle. ► If the display message does not disappear: consult a qualified specialist workshop.
	<p>* Active Steering Assist has reached the system limits (→ page 246). You have not steered independently for a considerable period of time.</p> <ul style="list-style-type: none"> ► Take over the steering and drive on in accordance with the traffic conditions.
Active Steering Assist Currently Unavailable Due to Multiple Emergency Stops	<p>* Active Steering Assist is temporarily unavailable due to multiple emergency stops.</p> <ul style="list-style-type: none"> ► Take over the steering and stop in accordance with the traffic conditions. ► Switch the vehicle off and then back on Active Steering Assist is available once more.

Display messages	Possible causes/consequences and ► Solutions
 <p>Initiating Emergency Stop</p>	<ul style="list-style-type: none"> * Your hands are not on the steering wheel. Active Steering Assist will initiate an emergency stop (→ page 246). <ul style="list-style-type: none"> ► Put your hands on the steering wheel. <p>Information on canceling an emergency stop (→ page 248).</p>
<p>Active Emergency Stop Assist Currently Unavailable See Operator's Manual</p>	<ul style="list-style-type: none"> * Active Emergency Stop Assist is temporarily unavailable. The ambient conditions are outside the system limits (→ page 248). As soon as the ambient conditions are within the system limits, the system will become available again. <ul style="list-style-type: none"> ► Drive on or ► If the display message does not disappear, stop the vehicle in accordance with the traffic conditions and restart the vehicle. * Vehicles without the Driving Assistance Package: Active Emergency Stop Assist is temporarily unavailable due to multiple emergency stops. <ul style="list-style-type: none"> ► Take over the steering and stop in accordance with the traffic conditions. ► Switch the vehicle off and then back on <p>Active Emergency Stop Assist will be available once more.</p>
<p>Active Emergency Stop Assist Inoperative</p>	<ul style="list-style-type: none"> * Active Emergency Stop Assist is malfunctioning. <ul style="list-style-type: none"> ► Drive on or

Display messages	Possible causes/consequences and ► Solutions
<p>Active Lane Change Assist Currently Unavailable See Operator's Manual</p>	<ul style="list-style-type: none"> ► Stop the vehicle in accordance with the traffic conditions and restart the vehicle. ► If the display message does not disappear: consult a qualified specialist workshop. <p>* Active Lane Change Assist is temporarily unavailable. The ambient conditions are outside the system limits (→ page 250). As soon as the ambient conditions are within the system limits, the system will become available again.</p> <ul style="list-style-type: none"> ► Drive on or ► If the display message does not disappear, stop the vehicle in accordance with the traffic conditions and restart the vehicle.
<p>Active Lane Change Assist Inoperative</p>	<p>* Active Lane Change Assist is malfunctioning.</p> <ul style="list-style-type: none"> ► Drive on or ► Stop the vehicle in accordance with the traffic conditions and restart the vehicle. ► If the display message does not disappear: consult a qualified specialist workshop.
<p>Automatic Lane Change Currently Unavailable See Operator's Manual</p>	<p>* Active Lane Change Assist is temporarily unavailable. The ambient conditions are outside the system limits (→ page 250). As soon as the ambient conditions are within the system limits, the system will become available again.</p> <ul style="list-style-type: none"> ► Drive on



Display messages	Possible causes/consequences and ► Solutions
	<p>or</p> <p>► If the display message does not disappear, stop the vehicle in accordance with the traffic conditions and restart the vehicle.</p>
<p>Automatic Lane Change Inoperative</p>	<p>* Active Lane Change Assist is malfunctioning.</p> <p>► Drive on</p> <p>or</p> <p>► Stop the vehicle in accordance with the traffic conditions and restart the vehicle.</p> <p>► If the display message does not disappear: consult a qualified specialist workshop.</p>
<p>Active Stop & Go Assist Currently Unavailable See Operator's Manual</p>	<p>* Active Stop-and-Go Assist is temporarily unavailable. Active Distance Assist DISTRONIC and Active Steering Assist are still available.</p> <p>The ambient conditions are outside the system limits (→ page 239).</p> <p>As soon as the ambient conditions are within the system limits, the system will become available again.</p> <p>► Drive on</p>
<p>Active Stop & Go Assist Inoperative See Operator's Manual</p>	<p>* Active Stop-and-Go Assist is malfunctioning.</p> <p>Active Stop-and-Go Assist has been deactivated. Active Distance Assist DISTRONIC and Active Steering Assist are still available.</p> <p>► Drive on</p> <p>or</p> <p>► Stop the vehicle in accordance with the traffic conditions and restart the vehicle.</p>

Display messages	Possible causes/consequences and ► Solutions
<p>Blind Spot Assist Currently Unavailable See Operator's Manual</p>	<p>► If the display message does not disappear: consult a qualified specialist workshop.</p> <p>* Blind Spot Assist is temporarily unavailable. The system limits have been reached (→ page 264). Once the cause of the problem is no longer present, the system will be available again.</p> <p>► Drive on or ► If the display message does not disappear, stop the vehicle in accordance with the traffic conditions and restart the vehicle.</p>
<p>Blind Spot Assist Inoperative</p>	<p>* Blind Spot Assist or the exit warning is malfunctioning.</p> <p>► Drive on or ► Stop the vehicle in accordance with the traffic conditions and restart the vehicle. ► If the display message does not disappear: consult a qualified specialist workshop.</p>
<p>Active Blind Spot Assist Currently Unavailable See Operator's Manual</p>	<p>* Active Blind Spot Assist is temporarily unavailable. The system limits have been reached (→ page 264). Once the cause of the problem is no longer present, the system will be available again.</p> <p>► Drive on or</p>

Display messages	Possible causes/consequences and ► Solutions
	<ul style="list-style-type: none"> ► If the display message does not disappear, stop the vehicle in accordance with the traffic conditions and restart the vehicle.
Active Blind Spot Assist Inoperative	<ul style="list-style-type: none"> * Active Blind Spot Assist or the exit warning is malfunctioning. <ul style="list-style-type: none"> ► Drive on or ► Stop the vehicle in accordance with the traffic conditions and restart the vehicle. ► If the display message does not disappear: consult a qualified specialist workshop.
Active Lane Keeping Assist Currently Unavailable See Operator's Manual	<ul style="list-style-type: none"> * Active Lane Keeping Assist is temporarily unavailable. The ambient conditions are outside the system limits (→ page 268). As soon as the ambient conditions are within the system limits, the system will become available again. <ul style="list-style-type: none"> ► Drive on
Active Lane Keeping Assist Inoperative	<ul style="list-style-type: none"> * Active Lane Keeping Assist is malfunctioning. <ul style="list-style-type: none"> ► Drive on or ► Stop the vehicle in accordance with the traffic conditions and restart the vehicle. ► If the display message does not disappear: consult a qualified specialist workshop.

Display messages	Possible causes/consequences and ► Solutions
<p data-bbox="194 248 471 326">Active Lane Keeping Assist Limited Range of Functions See Operator's Manual</p>	<p data-bbox="517 248 1062 274">* Active Lane Keeping Assist is available but restricted.</p> <ul data-bbox="535 279 1386 404" style="list-style-type: none"><li data-bbox="535 279 665 310">► Drive on<li data-bbox="535 315 572 341">or<li data-bbox="535 347 1367 378">► Stop the vehicle in accordance with the traffic conditions and restart the vehicle.<li data-bbox="535 378 1386 404">► If the display message does not disappear: consult a qualified specialist workshop.
<p data-bbox="203 419 360 502"></p> <p data-bbox="194 512 462 538">Initiating Emergency Stop</p>	<p data-bbox="517 419 1561 471">* Your hands are not on the steering wheel. The Active Lane Keeping Assist will initiate an emergency stop (→ page 268).</p> <ul data-bbox="535 476 951 507" style="list-style-type: none"><li data-bbox="535 476 951 507">► Put your hands on the steering wheel. <p data-bbox="535 523 1136 549">Information on canceling an emergency stop (→ page 248).</p>

Display messages	Possible causes/consequences and ► Solutions
 <p data-bbox="144 598 389 650">Temporarily Unavailable Sensors Dirty</p>	<p data-bbox="476 252 1363 273">* Front and corner radar sensors (hereafter "sensors") are malfunctioning. Possible causes:</p> <ul data-bbox="500 288 1151 381" style="list-style-type: none"><li data-bbox="500 288 735 308">• The sensors are dirty<li data-bbox="500 323 717 343">• Heavy rain or snow<li data-bbox="500 358 1151 379">• Extended country driving without other traffic, e.g. in the desert <p data-bbox="495 399 1646 451">Driving systems and driving safety systems may be malfunctioning or temporarily unavailable. The brake system, steering and drive system will continue to function normally.</p> <p data-bbox="495 462 704 482">► Drive on carefully.</p> <p data-bbox="495 513 1646 565">Once the causes of the problem are no longer present, the driving systems and driving safety systems will be available again and the corresponding symbols will be switched off.</p> <p data-bbox="495 576 907 596">If the display message does not disappear:</p> <ul data-bbox="495 607 1092 700" style="list-style-type: none"><li data-bbox="495 607 1092 627">► Stop the vehicle in accordance with the traffic conditions.<li data-bbox="495 642 1073 663">► Clean all sensor covers from the outside (→ page 229).<li data-bbox="495 677 717 698">► Restart the vehicle.

Display messages	Possible causes/consequences and ► Solutions
 <p data-bbox="194 766 471 818">Camera View Reduced See Operator's Manual</p>	<p data-bbox="526 248 1201 274">* The view of the multifunction camera is restricted. Possible causes:</p> <ul data-bbox="545 284 1681 409" style="list-style-type: none"> • Dirt on the windshield in the field of vision of the multifunction camera • Heavy rain, snow or fog • Mist on the inside or outside of the windshield: in certain weather conditions, mist can form on the inside or outside of the windshield during cold times of year in particular. <p data-bbox="545 419 1681 476">  This mist on the windshield will be removed automatically within a short time with the aid of a heater. The restriction is temporary. </p> <p data-bbox="545 481 1690 538">Driving systems and driving safety systems may be malfunctioning or temporarily unavailable. The brake system, steering and drive system will continue to function normally.</p> <ul data-bbox="545 543 1201 647" style="list-style-type: none"> ► Drive on carefully. ► To remove mist from the outside, wipe once (→ page 152). ► To remove the mist from the inside, press  (→ page 164). <p data-bbox="545 663 1690 720">Once the causes of the problem are no longer present, the driving systems and driving safety systems will be available again and the corresponding symbols will be switched off.</p> <p data-bbox="545 725 1404 751">If the display message does not disappear even after a driving time of about 15 minutes:</p> <ul data-bbox="545 756 1469 854" style="list-style-type: none"> ► Stop the vehicle in accordance with the traffic conditions. ► Clean the windshield, especially in the position of the multifunction camera (→ page 229). ► Restart the vehicle.

512 Display messages and warning/indicator lamps

Display messages	Possible causes/consequences and ► Solutions
PRE-SAFE Inoperative See Operator's Manual	<ul style="list-style-type: none">* The PRE-SAFE® functions are malfunctioning.<ul style="list-style-type: none">► Consult a qualified specialist workshop.
PRE-SAFE Pulse Side Inoperative See Operator's Manual	<ul style="list-style-type: none">* The PRE-SAFE® Impulse Side system is malfunctioning or inoperative after having already been triggered.<ul style="list-style-type: none">► Consult a qualified specialist workshop.
PRE-SAFE PLUS Inoperative See Operator's Manual	<ul style="list-style-type: none">* The PRE-SAFE® PLUS system is malfunctioning.<ul style="list-style-type: none">► Drive onor► Stop the vehicle in accordance with the traffic conditions and restart the vehicle.► If the display message does not disappear: consult a qualified specialist workshop.

Parking assistance systems



Display messages	Possible causes/consequences and ► Solutions
PARKTRONIC Inoperative See Operator's Manual	<ul style="list-style-type: none">* Parking Assist PARKTRONIC is malfunctioning.<ul style="list-style-type: none">Once the cause of the problem is no longer present, the system will be available again.► Continue driving while paying attention to the vehicle's surroundings.or



Display messages	Possible causes/consequences and ► Solutions
	<ul style="list-style-type: none"> ► Stop the vehicle in accordance with the traffic conditions and restart the vehicle. ► If the display message still appears, consult a qualified specialist workshop.
<p>Active Parking Assist and PARKTRONIC Inoperative See Operator's Manual</p>	<p>* Active Parking Assist and Parking Assist PARKTRONIC are malfunctioning. Once the cause of the problem is no longer present, the system will be available again.</p> <ul style="list-style-type: none"> ► Continue driving while paying attention to the vehicle's surroundings. <p>or</p> <ul style="list-style-type: none"> ► Stop the vehicle in accordance with the traffic conditions and restart the vehicle. ► If the display message still appears, consult a qualified specialist workshop.
<p>Active Parking Assist Limited Availability of Maneuvering Assistance See Operator's Manual</p>	<p>* Active Parking Assist's maneuvering assistant is temporarily unavailable or only partially available.</p> <ul style="list-style-type: none"> ► Clean all sensors of the parking and camera system (→ page 375). ► If the display message still appears, consult a qualified specialist workshop.





Mercedes-Benz emergency call system

Display messages	Possible causes/consequences and ► Solutions
 <p data-bbox="144 384 260 408">Inoperative</p>	<p data-bbox="473 291 1628 342">* The Mercedes-Benz emergency call system is malfunctioning. The Mercedes me connect system is also malfunctioning.</p> <ul style="list-style-type: none"> <li data-bbox="491 353 916 377">► Consult a qualified specialist workshop.

Battery

Display messages	Possible causes/consequences and ► Solutions
 <p data-bbox="144 653 399 705">12 V On-board Electrical System Service Required</p>	<p data-bbox="473 560 1027 584">* The 12 V on-board electrical system is malfunctioning.</p> <ul style="list-style-type: none"> <li data-bbox="491 594 1036 618">► Consult a qualified specialist workshop immediately.
 <p data-bbox="144 819 393 871">Stop Vehicle See Operator's Manual</p>	<p data-bbox="473 726 1258 750">* The 12 V battery is no longer being charged and the state of charge is too low.</p> <div data-bbox="500 770 1646 812" style="border: 1px solid black; padding: 5px;"> <p data-bbox="510 778 1073 801">! NOTE Possible engine damage if you continue driving</p> </div> <ul style="list-style-type: none"> <li data-bbox="510 819 1036 843">► Do not continue driving under any circumstances.



Display messages	Possible causes/consequences and ► Solutions
	<p>► Consult a qualified specialist workshop.</p> <ul style="list-style-type: none"> ► Stop the vehicle immediately in accordance with the traffic conditions. Do not continue driving. ► Switch off the vehicle. ► Consult a qualified specialist workshop.
 <p>Switch on vehicle to charge the 12 V battery</p>	<p>* The vehicle is off and the state of charge of the 12 V battery is too low.</p> <ul style="list-style-type: none"> ► Switch off electrical consumers that are not required. ► Drive for 30–60 mins. <p>or</p> <ul style="list-style-type: none"> ► Charge the 12 V battery when stationary (→ page 394). ► Plug-in hybrid: Charge the vehicle at a charging station (→ page 204).
 <p>Stop Vehicle To Charge the 12 V Battery Do Not Switch Off Vehicle</p>	<p>* The state of charge of the 12 V battery is too low.</p> <ul style="list-style-type: none"> ► Stop the vehicle immediately in accordance with the traffic conditions. Do not continue driving. ► Leave the vehicle running ► If the display message disappears: drive on. ► If the display message does not disappear: consult a qualified specialist workshop.

Display messages	Possible causes/consequences and ► Solutions
 <p data-bbox="144 339 393 391">Stop Vehicle See Operator's Manual</p>	<p data-bbox="473 249 1023 273">* The 48 V on-board electrical system is malfunctioning.</p> <ul style="list-style-type: none"> <li data-bbox="495 283 1452 307">► Stop the vehicle immediately in accordance with the traffic conditions. Do not continue driving. <li data-bbox="495 318 746 341">► Switch off the vehicle. <li data-bbox="495 352 912 376">► Consult a qualified specialist workshop.
 <p data-bbox="144 508 402 584">Battery Overheated Stop! Everyone Get Out! Outdoors if Possible</p>	<p data-bbox="473 418 1016 442">* The 48 V battery is overheating. There is a risk of fire.</p> <ul style="list-style-type: none"> <li data-bbox="495 452 1215 476">► Stop the vehicle immediately in accordance with the traffic conditions. <li data-bbox="495 486 1387 510">► If possible, stop the vehicle in the open air and ensure that all vehicle occupants get out. <li data-bbox="495 521 1600 552">  Supporting vehicle functions may activate automatically, e.g. air-recirculation mode as part of climate control. <li data-bbox="495 562 765 586">► Do not continue driving. <li data-bbox="495 596 1300 620">► If smoke is present, leave the danger zone and call the fire service immediately. <li data-bbox="495 630 1330 654">► Consult a qualified specialist workshop even if there are no external signs of a fire.
 <p data-bbox="144 764 393 816">48 V Battery See Operator's Manual</p>	<p data-bbox="473 674 1094 698">* The 48 V on-board electrical system has function restrictions.</p> <p data-bbox="495 708 1434 732">Comfort functions, such as the air conditioning system, may be available only to a limited extent.</p> <p data-bbox="495 742 733 766">It is possible to drive on.</p> <ul style="list-style-type: none"> <li data-bbox="495 777 1535 800">► If the display message remains active permanently, consult a qualified specialist workshop immediately.



Display messages	Possible causes/consequences and ► Solutions
 <p data-bbox="194 341 471 393">Please Wait Charging 48 V Battery...</p>	<p data-bbox="526 248 1690 300">* The 48 V battery is discharged. You have switched on the vehicle while the 12 V battery was being charged with a suitable charger or while another vehicle was providing starting assistance.</p> <p data-bbox="545 310 1690 362">The discharged 48 V battery is charged automatically via the voltage converter. After a few minutes, the Starting Possible Again display message will be shown on the driver's display.</p> <ul style="list-style-type: none"> <li data-bbox="545 372 748 398">► Start the vehicle. <li data-bbox="545 409 1690 461">► Drive the vehicle for a while to charge the 12 V battery and the 48 V battery after disconnecting the charger from the vehicle. <p data-bbox="545 481 1358 507">If the Starting Possible Again display message does not appear after a few minutes:</p> <ul style="list-style-type: none"> <li data-bbox="545 518 803 543">► Try to start the vehicle. <li data-bbox="545 554 1247 580">► If the vehicle does not start, consult a qualified specialist workshop.
<p data-bbox="194 595 434 621">Starting Possible Again</p>	<p data-bbox="526 595 1275 621">* The 48 V battery has been charged automatically via the voltage converter.</p> <ul style="list-style-type: none"> <li data-bbox="545 626 1413 652">► Start the vehicle and drive for a while to charge the 12 V battery and the 48 V battery.

Tire pressure monitor

Display messages	Possible causes/consequences and ► Solutions
<p data-bbox="194 797 471 849">Tire Pressure Monitor Currently Unavailable</p>	<p data-bbox="526 797 1690 849">* There is interference from a powerful radio signal source As a result, no signals from the tire pressure sensors are being received. The tire pressure monitoring system is temporarily unavailable.</p> <p data-bbox="545 859 1543 885">The tire pressure monitoring system will restart automatically as soon as the cause has been rectified.</p>

Display messages	Possible causes/consequences and ► Solutions
	<ul style="list-style-type: none"> ► Drive on
Tire Pressure Monitor Inoperative	<ul style="list-style-type: none"> * The tire pressure monitoring system is malfunctioning. <div data-bbox="495 332 1648 484" style="border: 1px solid gray; padding: 5px; margin-top: 10px;"> <p>⚠ WARNING There is a risk of an accident if the tire pressure monitoring system is malfunctioning</p> <p>The tire pressure monitoring system cannot issue a warning if there is pressure loss in one or more of the tires. Tires with insufficient tire pressure may impair the driving characteristics as well as steering and braking.</p> <p>► Have the tire pressure monitoring system checked at a qualified specialist workshop.</p> </div>
Tire Pressure Monitor Inoperative Tire Pressure Sensors Missing	<ul style="list-style-type: none"> * The wheels installed do not have suitable tire pressure sensors. The tire pressure monitoring system is deactivated. <ul style="list-style-type: none"> ► Install wheels with suitable tire pressure sensors.
 <p>Wheel Sensor(s) Missing</p>	<ul style="list-style-type: none"> * There is no signal from the tire pressure sensor in at least one wheel. No pressure value is displayed for the affected tire. <ul style="list-style-type: none"> ► Have the faulty tire pressure sensor replaced at a qualified specialist workshop.
 <p>Check Tires</p>	<ul style="list-style-type: none"> * The tire pressure in one or more tires has dropped significantly. The wheel position is displayed. A warning tone also sounds.

Display messages	Possible causes/consequences and ► Solutions
	<p>▲ WARNING Risk of an accident due to insufficient tire pressure</p> <ul style="list-style-type: none"> • The tires can burst. • The tires can wear excessively and/or unevenly. • The driving characteristics as well as the steering and braking may be greatly impaired. <p>You could then lose control of the vehicle.</p> <ul style="list-style-type: none"> ► Observe the recommended tire pressures. ► Adjust the tire pressure if necessary. <p>► Stop the vehicle in accordance with the traffic conditions.</p> <p>► Check the tire pressure (→ page 406) and the tires.</p>
 <p>Please Correct Tire Pressure</p>	<p>* The tire pressure is too low in at least one of the tires, or the difference in tire pressure between the individual wheels is too great.</p> <ul style="list-style-type: none"> ► Check the tire pressure and add air, if necessary. ► When the tire pressure is correct, restart the tire pressure monitor (→ page 411).

Display messages	Possible causes/consequences and ► Solutions
 <p data-bbox="144 339 399 366">Warning Tire Malfunction</p>	<p data-bbox="476 249 1356 276">* The pressure in one or more tires has dropped suddenly. The wheel position is displayed.</p> <div data-bbox="500 291 1646 332"><p data-bbox="506 298 1110 325">▲ WARNING Risk of an accident from driving with a flat tire</p></div> <ul data-bbox="513 339 1541 401" style="list-style-type: none"><li data-bbox="513 339 938 366">• The tires can overheat and be damaged.<li data-bbox="513 370 1541 401">• The driving characteristics as well as the steering and braking characteristics may be greatly impaired. <p data-bbox="513 415 920 442">You could then lose control of the vehicle.</p> <ul data-bbox="513 446 1600 570" style="list-style-type: none"><li data-bbox="513 446 814 473">► Do not drive with a flat tire.<li data-bbox="513 477 1600 535">► Do not exceed the maximum permissible driving distance in emergency mode and the maximum permissible speed with a flat MOExtended tire.<li data-bbox="513 539 851 566">► Observe the notes on flat tires. <p data-bbox="495 594 809 621">Notes on flat tire (→ page 382).</p> <ul data-bbox="495 625 1092 687" style="list-style-type: none"><li data-bbox="495 625 1092 652">► Stop the vehicle in accordance with the traffic conditions.<li data-bbox="495 656 685 687">► Check the tires.
 <p data-bbox="144 798 316 825">Tires Overheated</p>	<p data-bbox="476 708 1609 756">* At least one tire is overheating. The affected tires are displayed in red. At temperatures close to the limit value, the tires are displayed in yellow.</p> <div data-bbox="500 770 1646 812"><p data-bbox="506 778 1179 804">▲ WARNING Risk of an accident from driving with overheated tires</p></div> <p data-bbox="513 819 778 846">Overheated tires can burst.</p>

Display messages	Possible causes/consequences and ► Solutions
 <p data-bbox="195 399 343 422">Reduce Speed</p>	<p data-bbox="561 252 1698 291">► Reduce speed so that the tires cool down.</p> <p data-bbox="528 308 1661 358">* At least one tire is overheating. The affected tires are displayed in red. At temperatures close to the limit value, the tires are displayed in yellow.</p> <p data-bbox="556 379 1698 415">▲ WARNING Risk of an accident from driving with overheated tires</p> <p data-bbox="561 425 1698 451">Overheated tires can burst.</p> <p data-bbox="561 456 1698 482">► Reduce speed so that the tires cool down.</p>



Tire pressure loss warning system



Display messages	Possible causes/consequences and ► Solutions
<p data-bbox="195 639 449 688">Check Tire and Tire Pressure</p>	<p data-bbox="528 639 1336 698">* Canada only: The tire pressure loss warning system has detected a significant loss of pressure.</p> <p data-bbox="556 718 1698 755">▲ WARNING Risk of an accident due to insufficient tire pressure</p> <ul data-bbox="569 765 1443 858" style="list-style-type: none"> • The tires can burst. • The tires can wear excessively and/or unevenly. • The driving characteristics as well as the steering and braking may be greatly impaired.

522 Display messages and warning/indicator lamps

Display messages	Possible causes/consequences and ► Solutions
	<p>You could then lose control of the vehicle.</p> <ul style="list-style-type: none">► Observe the recommended tire pressures.► Adjust the tire pressure if necessary. <p>► Stop the vehicle in accordance with the traffic conditions.</p> <p>► Check the tire pressure (→ page 406) and the tires.</p> <p>► When the tire pressure is correct, restart the tire pressure loss warning system (→ page 412).</p>
Check Tire Pressure Then Restart Run Flat Indicator	<p>* Canada only: The tire pressure loss warning system generated a display message and has not been restarted since.</p> <p>► When the tire pressure is correct, restart the tire pressure loss warning system (→ page 412).</p>
Run Flat Indicator Inoperative	<p>* Canada only: The tire pressure loss warning system is malfunctioning.</p> <p>► Consult a qualified specialist workshop.</p>

Engine oil

Display messages	Possible causes/consequences and ► Solutions
 <p data-bbox="194 383 462 461">Check Engine Oil Level At Next Refueling (Add 1 Quart)</p>	<p data-bbox="526 290 1071 315">* The engine oil level has dropped to the minimum level.</p> <div data-bbox="545 331 1690 419" style="border: 1px solid gray; padding: 5px;"> <p data-bbox="554 341 1256 367">! NOTE Engine damage caused by driving with insufficient engine oil</p> <p data-bbox="554 378 1053 409">► Avoid long journeys with insufficient engine oil.</p> </div> <p data-bbox="545 435 1247 461">► When next refueling, add 1.1 US qt (1 l) of engine oil (→ page 367).</p> <p data-bbox="545 476 887 502">Notes on engine oil (→ page 444).</p>
 <p data-bbox="194 616 471 668">Engine Oil Level Reduce Oil Level</p>	<p data-bbox="526 523 850 549">* The engine oil level is too high.</p> <div data-bbox="545 564 1690 652" style="border: 1px solid gray; padding: 5px;"> <p data-bbox="554 574 1210 600">! NOTE Engine damage caused by driving with excess engine oil</p> <p data-bbox="554 611 1016 642">► Avoid long journeys with excess engine oil.</p> </div> <p data-bbox="545 668 1459 694">► Consult a qualified specialist workshop immediately and have the engine oil level reduced.</p>
 <p data-bbox="194 802 415 854">Engine Oil Level Stop Switch Off Vehicle</p>	<p data-bbox="526 709 840 735">* The engine oil level is too low.</p> <div data-bbox="545 751 1690 839" style="border: 1px solid gray; padding: 5px;"> <p data-bbox="554 761 1256 787">! NOTE Engine damage caused by driving with insufficient engine oil</p> <p data-bbox="554 797 1053 828">► Avoid long journeys with insufficient engine oil.</p> </div> <p data-bbox="545 849 1506 875">► Stop the vehicle immediately in accordance with the traffic conditions. Do not continue driving.</p>

Display messages	Possible causes/consequences and ► Solutions
	<ul style="list-style-type: none"> ► Switch off the vehicle. ► Add 1.1 US qt (1 l) of engine oil (→ page 367). ► Check the engine oil level. <p>Notes on engine oil (→ page 444).</p>
 <p>Engine Oil Pressure Stop Switch Off Vehicle</p>	<p>* The oil pressure is too low.</p> <div style="border: 1px solid black; padding: 5px; margin: 5px 0;"> <p>! NOTE Engine damage caused by driving with insufficient oil pressure</p> <p>► Avoid driving with insufficient oil pressure.</p> </div> <ul style="list-style-type: none"> ► Stop the vehicle immediately in accordance with the traffic conditions. Do not continue driving. ► Switch off the vehicle. ► Consult a qualified specialist workshop.
 <p>Engine Oil Level Cannot Be Measured</p>	<p>* The electrical connection to the oil level sensor has been interrupted or the oil level sensor is faulty.</p> <ul style="list-style-type: none"> ► Consult a qualified specialist workshop.

Warning and indicator lamps

Overview of indicator and warning lamps

Some systems will perform a self-test when the vehicle is switched on. Some indicator and warning lamps may briefly light up or flash. This behavior is non-critical. These indicator and warning lamps indicate a malfunction only if they light up or flash after the vehicle has been started or during a journey.



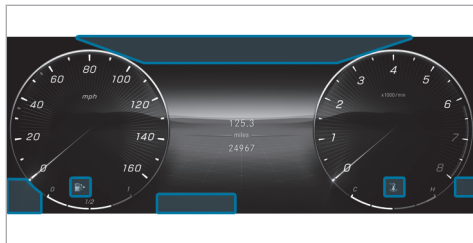

The indicator and warning lamps are located in the highlighted display sections.

Driver display





Indicator and warning lamps



Occupant safety

-  Restraint system (→ page 527)
-  Seat belt (→ page 527)
-  Occupant presence reminder (white) (→ page 527)
-  Occupant presence reminder (yellow) (→ page 527)



Drive system



-  Reduced power (→ page 529)
-  System error (→ page 529)
-  Electrical malfunction (→ page 529)

Vehicle







-  Power steering (yellow) (→ page 530)
-  Power steering (red) (→ page 530)
-  Rear-axle steering (yellow) (→ page 530)

Engine



-  Coolant temperature (→ page 531)
-  Engine diagnostics (→ page 531)

-  Vehicles with gasoline engines: engine operating temperature (→ page 531)
-  Electrical malfunction (→ page 531)
-  Reserve fuel with fuel filler flap location indicator (→ page 531)

Brakes

-  Electric parking brake (yellow) (→ page 536)
-  USA: electric parking brake (red) (→ page 536)
-  Canada: electric parking brake (red) (→ page 536)
-  USA: Recuperative Brake System (→ page 536)
-  Canada: brakes (yellow) (→ page 536)
-  USA: brakes (red) (→ page 536)
-  Canada: brakes (red) (→ page 536)

Driving and driving safety systems

-  ABS (→ page 539)
-  ESP® (→ page 539)

526 Display messages and warning/indicator lamps

 ESP® OFF (→ page 539)

 ATTENTION ASSIST (→ page 539)

 Traffic Sign Assist (→ page 539)

 Distance warning (→ page 539)

 Active Brake Assist (→ page 539)

 Active Brake Assist (→ page 539)

 Active Brake Assist (→ page 539)

Mercedes-Benz emergency call system

 Mercedes-Benz emergency call system
(→ page 543)

Tire pressure monitoring system

 Tire pressure monitoring system
(→ page 543)

Exterior lighting

 Side lights (→ page 140)

 Low beam (→ page 140)

 High beam (→ page 141)

 Turn signal lights (→ page 141)

 Rear fog light (→ page 140)

Symbols on the central display



 Drive Away Assist (→ page 287)

 Rear cross traffic warning (→ page 288)

 Close-range braking (→ page 289)



Occupant safety

Warning/indicator lamp	Possible causes/consequences and ► Solutions
 <p data-bbox="195 383 443 435">Restraint system warning lamp</p>	<p data-bbox="508 290 1173 341">* The restraint system red warning lamp is lit while the vehicle is on. The restraint system is malfunctioning (→ page 43).</p> <div data-bbox="526 357 1690 481" style="border: 1px solid gray; padding: 5px;"> <p data-bbox="535 367 1247 398">▲ WARNING Risk of injury due to malfunctions in the restraint system</p> <p data-bbox="545 409 1617 435">Components in the restraint system may be activated unintentionally or not deploy as planned in an accident.</p> <ul style="list-style-type: none"> <li data-bbox="545 440 1506 471">► Have the restraint system checked and repaired immediately at a qualified specialist workshop. </div> <p data-bbox="526 492 674 523">Plug-in hybrid:</p> <div data-bbox="526 533 1690 782" style="border: 1px solid gray; padding: 5px;"> <p data-bbox="535 543 1228 574">▲ DANGER Risk of death due to the restraint system malfunctioning</p> <p data-bbox="545 585 1681 637">Components in the restraint system may be activated unintentionally or not deploy as intended in an accident. In the event of an accident, the high-voltage on-board electrical system may not be deactivated as intended.</p> <p data-bbox="545 647 1635 699">You may receive an electric shock if you touch the damaged components of the high-voltage on-board electrical system.</p> <ul style="list-style-type: none"> <li data-bbox="545 704 1506 735">► Have the restraint system checked and repaired immediately at a qualified specialist workshop. <li data-bbox="545 740 1099 771">► After an accident, switch off the vehicle immediately. </div> <ul style="list-style-type: none"> <li data-bbox="526 792 739 823">► Drive on carefully. <li data-bbox="526 828 960 859">► Note the messages on the driver display.

Warning/indicator lamp	Possible causes/consequences and ► Solutions
 <p data-bbox="144 381 371 433">Seat belt warning lamp flashes</p>	<ul style="list-style-type: none"> <li data-bbox="476 246 1021 272">► Consult a qualified specialist workshop immediately. <p data-bbox="463 288 1391 339">* The red seat belt warning lamp flashes and an intermittent warning tone sounds. The driver or front passenger has not fastened his/her seat belt while the vehicle is in motion.</p> <ul style="list-style-type: none"> <li data-bbox="476 350 857 376">► Fasten your seat belt (→ page 43). <li data-bbox="476 379 929 405">There are objects on the front passenger seat. <li data-bbox="476 408 1009 434">► Remove the objects from the front passenger seat.
 <p data-bbox="144 543 371 595">Seat belt warning lamp lights up</p>	<p data-bbox="463 450 1308 476">* The red seat belt warning lamp lights up for six seconds once the vehicle has started.</p> <p data-bbox="476 479 986 505">In addition, an intermittent warning tone may sound.</p> <p data-bbox="476 508 1411 534">The red seat belt warning lamp reminds the driver and front passenger to fasten their seat belts.</p> <ul style="list-style-type: none"> <li data-bbox="476 539 857 565">► Fasten your seat belt (→ page 43). <p data-bbox="476 581 1465 607">If you have placed objects on the front passenger seat, the red seat belt warning lamp may remain lit.</p>
 <p data-bbox="144 723 371 801">Occupant presence reminder warning lamp (white)</p>	<p data-bbox="463 629 1049 655">* The white occupant presence reminder warning lamp is lit.</p> <p data-bbox="476 658 949 684">The occupant presence reminder is deactivated.</p> <ul style="list-style-type: none"> <li data-bbox="476 689 1119 715">► Switch on the occupant presence reminder, see (→ page 72).

Warning/indicator lamp	Possible causes/consequences and ► Solutions
 <p data-bbox="195 344 469 417">Occupant presence reminder warning lamp (yellow)</p>	<p data-bbox="510 251 1105 301">* The yellow occupant presence reminder warning lamp is lit. The occupant presence reminder is malfunctioning</p> <p data-bbox="524 311 957 334">► Note the messages on the driver display.</p>



Drive system

Warning/indicator lamp	Possible causes/consequences and ► Solutions
 <p data-bbox="195 657 417 707">Reduced warning lamp power</p>	<p data-bbox="510 564 975 614">* The yellow reduced-power warning lamp is on. Drive system power output is reduced.</p> <p data-bbox="524 624 957 647">► Note the messages on the driver display.</p>
 <p data-bbox="195 818 469 868">System malfunction warning lamp</p>	<p data-bbox="510 725 1500 774">* The red system error warning lamp is lit while the vehicle is in a state of operational readiness READY.</p> <p data-bbox="524 785 957 808">► Note the messages on the driver display.</p>

530 Display messages and warning/indicator lamps

Warning/indicator lamp	Possible causes/consequences and ► Solutions
 <p data-bbox="144 342 421 389">Electrical malfunction warning lamp</p>	<p data-bbox="458 249 962 298">* The red electrical malfunction warning lamp is on. There is a malfunction with the electrics.</p> <p data-bbox="476 308 907 335">► Note the messages on the driver display.</p>

Vehicle



Warning/indicator lamp	Possible causes/consequences and ► Solutions
 <p data-bbox="144 630 375 679">Power steering warning lamp (yellow)</p>	<p data-bbox="458 537 1184 586">* The yellow power steering warning lamp is lit while the vehicle is running. The power assistance or the steering itself is malfunctioning.</p> <p data-bbox="476 596 907 623">► Note the messages on the driver display.</p>
 <p data-bbox="144 788 375 837">Power steering warning lamp (red)</p>	<p data-bbox="458 695 1160 743">* The red power steering warning lamp is lit while the vehicle is running. The power assistance or the steering itself is malfunctioning.</p> <div data-bbox="482 767 1644 806"><p data-bbox="495 774 1110 801">▲ WARNING Risk of accident if steering capability is impaired</p></div> <p data-bbox="495 812 1369 839">If the steering does not function as intended, the vehicle's operating safety is jeopardized.</p>



Warning/indicator lamp	Possible causes/consequences and ► Solutions
	<ul style="list-style-type: none"> ► Pull over and stop the vehicle safely as soon as possible, paying attention to road and traffic conditions. Do not continue driving under any circumstances. ► Consult a qualified specialist workshop. <p>► Note the messages on the driver display.</p>
 <p>Rear axle steering warning lamp (yellow)</p>	<p>* The yellow rear axle steering warning lamp is lit while the vehicle is running. The rear axle steering is malfunctioning.</p> <p>► Note the messages on the driver's display.</p>

Engine

Warning/indicator lamp	Possible causes/consequences and ► Solutions
 <p>Coolant warning lamp (red)</p>	<p>* The red coolant warning lamp is lit while the engine is running.</p> <p>Possible causes:</p> <ul style="list-style-type: none"> • The temperature sensor is malfunctioning • The coolant level is too low • The air supply to the radiator is obstructed



Warning/indicator lamp	Possible causes/consequences and ► Solutions
	<ul style="list-style-type: none">• The radiator fan is faulty• The engine coolant pump is faulty <p>If there is an additional warning tone, the coolant temperature has exceeded the maximum permissible temperature.</p> <div data-bbox="482 368 1646 410"><p>▲ WARNING Risk of burns when opening the hood</p></div> <p>If you open the hood in the event of an overheated engine or fire in the engine compartment, the following situations may occur:</p> <ul style="list-style-type: none">• You may come into contact with hot gases.• You may come into contact with other escaping hot operating fluids. <ul style="list-style-type: none">► Before opening the hood, allow the engine to cool down.► In the event of a fire in the engine compartment, keep the hood closed and call the fire service. <ul style="list-style-type: none">► Stop immediately in accordance with the traffic conditions and switch off the vehicle. Do not continue driving.► Note the messages on the driver display. <p>If the coolant temperature display is at the lower end of the temperature scale:</p> <ul style="list-style-type: none">► Consult a qualified specialist workshop. <p>If the coolant temperature display is at the upper end of the temperature scale:</p> <ul style="list-style-type: none">► Exit the vehicle and keep a safe distance from it until the engine has cooled down.



Warning/indicator lamp	Possible causes/consequences and ► Solutions
	<ul style="list-style-type: none"> ► Check the coolant level (→ page 369). ► Make sure that the air supply to the radiator is not obstructed. ► Avoiding high loads on the engine, drive to the nearest qualified specialist workshop. In doing so, ensure that the coolant temperature display remains below the red area.
 <p data-bbox="194 481 462 528">Coolant warning lamp (yellow)</p>	<p data-bbox="508 388 1164 414">* The yellow coolant warning lamp is lit while the engine is running.</p> <p data-bbox="526 424 693 445">Possible causes:</p> <ul style="list-style-type: none"> • The temperature sensor is malfunctioning • The charge air, transmission oil or battery cooling is faulty • The radiator shutters are blocked or defective <p data-bbox="526 564 1386 590">► Avoiding high loads on the engine, drive to the nearest qualified specialist workshop.</p>
 <p data-bbox="194 704 462 730">Check Engine warning lamp</p>	<p data-bbox="508 611 1321 657">* The yellow engine diagnostics warning lamp is lit while the engine is running. A malfunction has occurred in the engine, the exhaust system or the fuel system.</p> <p data-bbox="526 668 1506 694">This may cause the emissions limit values to be exceeded and the engine to run in emergency mode.</p> <p data-bbox="526 704 1681 751">In some states, legal requirements stipulate that you must immediately consult a qualified specialist workshop as soon as the yellow engine diagnostics warning lamp lights up.</p> <p data-bbox="526 761 1339 787">► Have the vehicle checked as soon as possible at a qualified specialist workshop.</p>



Warning/indicator lamp	Possible causes/consequences and ► Solutions
 <p data-bbox="144 342 421 394">Electrical malfunction warning lamp</p>	<p data-bbox="458 249 957 298">* The red electrical malfunction warning lamp is lit. There is a malfunction in the electrics.</p> <ul data-bbox="476 308 907 335" style="list-style-type: none"><li data-bbox="476 308 907 335">► Note the messages on the driver display.
 <p data-bbox="144 503 408 555">Engine operating temperature warning lamp</p>	<p data-bbox="458 410 1530 458">* Vehicles with gasoline engines: after a cold start, the blue engine operating temperature warning lamp is on. Engine output and engine torque are reduced.</p> <ul data-bbox="476 469 981 496" style="list-style-type: none"><li data-bbox="476 469 981 496">► Take this into consideration in your driving style.
 <p data-bbox="144 664 408 715">Fuel reserve warning lamp flashes</p>	<p data-bbox="458 570 1628 619">* The yellow fuel reserve warning lamp lights up while you are driving. There has been pressure loss in the fuel system. The fuel filler cap is not closed correctly or the fuel system is leaking.</p> <ul data-bbox="476 629 746 656" style="list-style-type: none"><li data-bbox="476 629 746 656">► Close the fuel filler cap. <p data-bbox="476 681 999 708">If the fuel filler cap has already been closed correctly:</p> <ul data-bbox="476 718 898 745" style="list-style-type: none"><li data-bbox="476 718 898 745">► Consult a qualified specialist workshop.

Warning/indicator lamp	Possible causes/consequences and ► Solutions
 <p data-bbox="195 342 454 394">Fuel reserve warning lamp lights up</p>	<p data-bbox="513 249 1249 301">* The yellow fuel reserve warning lamp lights up while the engine is running. The fuel supply has dropped into the reserve range.</p> <ul data-bbox="528 308 633 335" style="list-style-type: none"><li data-bbox="528 308 633 335">► Refuel.



Brakes



Warning/indicator lamp	Possible causes/consequences and ► Solutions
 <p>Electric parking brake indicator lamp (red) (USA only)</p>  <p>Electric parking brake indicator lamp (red) (Canada only)</p>  <p>Electric parking brake indicator lamp (yellow)</p>	<p>* The red electric parking brake indicator lamp flashes or is lit.</p> <p>The yellow electric parking brake indicator lamp is also lit up in the event of a malfunction.</p> <ul style="list-style-type: none">► Note the messages on the driver display.



Warning/indicator lamp	Possible causes/consequences and ► Solutions
<div data-bbox="205 253 362 334" data-label="Image"> </div> <p data-bbox="195 342 432 394">RBS warning lamp (USA only)</p> <div data-bbox="205 399 362 480" data-label="Image"> </div> <p data-bbox="195 488 447 540">Brakes warning lamp (yellow) (Canada only)</p>	<p data-bbox="519 249 1696 301">*The yellow  warning lamp (USA only) or the yellow  brake warning lamp (Canada only) is lit while the vehicle is running.</p> <div data-bbox="537 322 1696 471" data-label="Complex-Block" style="border: 1px solid gray; padding: 5px;"> <p data-bbox="547 327 1221 353">▲ WARNING Risk of an accident due to a brake system malfunction</p> <p data-bbox="547 368 1310 394">If the brake system is malfunctioning, braking characteristics may be impaired.</p> <ul data-bbox="547 399 1350 462" style="list-style-type: none"> <li data-bbox="547 399 759 425">▶ Drive on carefully. <li data-bbox="547 430 1350 462">▶ Have the brake system checked immediately at a qualified specialist workshop. </div> <p data-bbox="528 488 953 514">The Hill Start Assist may be malfunctioning.</p> <ul data-bbox="528 520 1443 618" style="list-style-type: none"> <li data-bbox="528 520 1443 545">▶ Adjust your speed and drive on carefully, leaving a suitable distance to the vehicle in front. <li data-bbox="528 551 1129 577">▶ If the driver's display shows a display message, observe it. <li data-bbox="528 582 953 618">▶ Consult a qualified specialist workshop.



Warning/indicator lamp	Possible causes/consequences and ► Solutions
 <p>Brakes warning lamp (USA only)</p>  <p>Brakes warning lamp (Canada only)</p>	<p>* The red brakes warning lamp is lit while the vehicle is running.</p> <p>Possible causes:</p> <ul style="list-style-type: none">• The brake force boosting is malfunctioning and the braking characteristics may be affected.• There is insufficient brake fluid in the brake fluid reservoir. <p>► Note the messages on the driver display.</p> <p>▲ WARNING Risk of accident and injury if brake force boosting is malfunctioning</p> <p>If brake force boosting is malfunctioning, increased brake pedal force may be necessary for braking. The braking characteristics may be impaired. The braking distance can increase in emergency braking situations.</p> <ul style="list-style-type: none">► Stop in a safe location immediately. Do not continue driving.► Consult a qualified specialist workshop. <p>▲ WARNING Risk of an accident due to low brake fluid level</p> <p>If the brake fluid level is too low, the braking effect and the braking characteristics may be impaired.</p> <ul style="list-style-type: none">► Pull over and stop the vehicle safely as soon as possible, paying attention to road and traffic conditions. Do not continue driving under any circumstances.► Consult a qualified specialist workshop.► Do not add brake fluid.

Driving and driving safety systems

Warning/indicator lamp	Possible causes/consequences and ► Solutions
 <p data-bbox="194 383 378 409">ABS warning lamp</p>	<p data-bbox="508 290 1136 341">* The yellow ABS warning lamp is lit while the vehicle is running. ABS is malfunctioning.</p> <p data-bbox="526 352 1118 378">If an additional warning tone sounds, EBD is malfunctioning.</p> <p data-bbox="526 388 1284 414">Other driving systems and driving safety systems may also be malfunctioning.</p> <ul style="list-style-type: none"> <li data-bbox="526 419 960 445">► Note the messages on the driver display. <div data-bbox="526 461 1690 673" style="border: 1px solid gray; padding: 5px;"> <p data-bbox="535 471 1256 502">⚠ WARNING There is a risk of skidding if EBD or ABS is malfunctioning</p> <p data-bbox="545 512 905 538">The wheels may lock during braking.</p> <p data-bbox="545 549 1672 600">The steerability and braking characteristics are heavily impaired and the braking distance may increase. In addition, other driving safety systems are switched off.</p> <ul style="list-style-type: none"> <li data-bbox="545 606 757 631">► Drive on carefully. <li data-bbox="545 642 1349 668">► Have the brake system checked immediately at a qualified specialist workshop. </div>
 <p data-bbox="194 787 462 813">ESP® warning lamp flashes</p>	<p data-bbox="508 694 1191 745">* The yellow ESP® warning lamp flashes while the vehicle is in motion. One or more wheels have reached their grip limit (→ page 232).</p> <ul style="list-style-type: none"> <li data-bbox="526 756 1191 782">► Adapt your driving style to suit the road and weather conditions.

Warning/indicator lamp	Possible causes/consequences and ► Solutions
 <p>ESP® warning lamp lights up</p>	<p>* The yellow ESP® warning lamp is lit while the vehicle is running. ESP® is malfunctioning. Other driving systems and driving safety systems (e.g. BAS) may also be malfunctioning.</p> <p>► Note the messages on the driver display.</p> <p>▲ WARNING Risk of skidding if ESP® is malfunctioning</p> <p>If ESP® is malfunctioning, ESP® cannot carry out vehicle stabilization. In addition, other driving safety systems are switched off.</p> <ul style="list-style-type: none">► Drive on carefully.► Have ESP® checked at a qualified specialist workshop.
 <p>ESP® OFF warning lamp</p>	<p>* The yellow ESP® OFF warning lamp is lit while the vehicle is running. ESP® is deactivated. Other driving systems and driving safety systems may also be inoperative.</p> <p>▲ WARNING Risk of skidding when driving with ESP® deactivated</p> <p>ESP® does not act to stabilize the vehicle. The availability of further driving safety systems is also limited.</p> <ul style="list-style-type: none">► Drive on carefully.► Deactivate ESP® only for as long as the situation requires.

Warning/indicator lamp	Possible causes/consequences and ► Solutions
	<p>If ESP® cannot be activated, ESP® is malfunctioning.</p> <ul style="list-style-type: none"> ► Have ESP® checked immediately at a qualified specialist workshop. <p>► Observe the notes on deactivating ESP® (→ page 232).</p>
 <p>ATTENTION ASSIST warning lamp</p>	<p>* The ATTENTION ASSIST warning lamp is lit. ATTENTION ASSIST is malfunctioning.</p> <ul style="list-style-type: none"> ► Consult a qualified specialist workshop.
 <p>Traffic Sign Assist warning lamp</p>	<p>* The Traffic Sign Assist warning lamp is lit. Traffic Sign Assist is malfunctioning.</p> <ul style="list-style-type: none"> ► Note the messages on the driver display.
 <p>Distance warning lamp</p>	<p>* The red distance warning lamp lights up while the vehicle is in motion. The distance to the vehicle in front is too small for the speed selected.</p> <p>If there is an additional warning tone, you are approaching an obstacle at too high a speed.</p> <ul style="list-style-type: none"> ► Be prepared to brake immediately. ► Increase the distance.

Warning/indicator lamp	Possible causes/consequences and ► Solutions
 <p data-bbox="144 384 417 436">Active Brake Assist warning lamp</p>	<p data-bbox="476 249 931 275">Function of Active Brake Assist (→ page 255).</p> <p data-bbox="476 291 1480 342">* The Active Brake Assist warning lamp is on. Due to dirty sensors or a malfunction, the system is not available or the range of functions is restricted.</p> <p data-bbox="476 353 907 379">► Note the messages on the driver display.</p>
 <p data-bbox="144 544 417 596">Active Brake Assist warning lamp</p>	<p data-bbox="476 451 1498 534">* The Active Brake Assist warning lamp is on. The system is switched off or the range of functions has been automatically restricted. This may be the case if the driver is not wearing a seat belt or another driving system has been activated.</p> <p data-bbox="476 544 1064 570">► Observe the notes on Active Brake Assist (→ page 255).</p>
 <p data-bbox="144 705 417 757">Active Brake Assist warning lamp</p>	<p data-bbox="476 612 1415 695">* The Active Brake Assist warning lamp is on. After you drive off, the system's range of functions will be restricted due to the teach-in process. Depending on the ambient conditions, the teach-in process may take a few minutes.</p> <p data-bbox="476 705 1064 731">► Observe the notes on Active Brake Assist (→ page 255).</p>

Mercedes-Benz emergency call system

Warning/indicator lamp	Possible causes/consequences and ► Solutions
 <p>Mercedes-Benz emergency call system warning lamp</p>	<p>*The Mercedes-Benz emergency call system is malfunctioning. The Mercedes me connect system is also malfunctioning.</p> <ul style="list-style-type: none"> ► Consult a qualified specialist workshop.

Tire pressure monitor

Warning/indicator lamp	Possible causes/consequences and ► Solutions
 <p>Tire pressure monitoring system warning lamp flashes</p>	<p>*The yellow tire pressure monitor warning lamp (pressure loss/malfunction) flashes for approximately one minute and then remains lit. The tire pressure monitoring system is malfunctioning.</p> <div style="background-color: #f0f0f0; padding: 5px; border: 1px solid #ccc;"> <p>⚠ WARNING There is a risk of an accident if the tire pressure monitoring system is malfunctioning</p> <p>The tire pressure monitoring system cannot issue a warning if there is pressure loss in one or more of the tires. Tires with insufficient tire pressure may impair the driving characteristics as well as steering and braking.</p> <ul style="list-style-type: none"> ► Have the tire pressure monitoring system checked at a qualified specialist workshop. </div>

Warning/indicator lamp



Tire pressure monitoring system warning lamp lights up

Possible causes/consequences and ► Solutions

* The yellow tire pressure monitoring system warning lamp (pressure loss/malfunction) is lit. The tire pressure monitoring system has detected a loss of pressure in at least one tire.

▲ WARNING Risk of an accident due to insufficient tire pressure

- The tires can burst.
- The tires can wear excessively and/or unevenly.
- The driving characteristics as well as the steering and braking may be greatly impaired.

You could then lose control of the vehicle.

- Observe the recommended tire pressures.
- Adjust the tire pressure if necessary.

- Stop the vehicle in accordance with the traffic conditions.
- Check the tire pressure and the tires.

1, 2, 3 ...

(SmartKey) battery.....	75
4MATIC.....	201
48 V on-board electrical system	
Displays in the driver's display.....	300
Operating safety.....	26

A

A/C function	
Activating/deactivating (MBUX).....	163
Activating/deactivating (operating unit).....	162
ABS	231
Acceleration	
Kickdown.....	200
Optimized acceleration.....	180
Accelerator pedal	192
Accident prevention	287
Accident, emergency call	354
Activating/deactivating the acoustic locking verification signal	74

Active Blind Spot Assist

Activating/deactivating.....	268
Brake application.....	267
Exit warning.....	264
Function.....	264

Active Brake Assist

Function.....	255
Setting.....	260

Active Distance Assist DISTRONIC

Activating/deactivating.....	241
Active Emergency Stop Assist.....	248
Active Lane Change Assist.....	250
Active Speed Limit Assist.....	243
Calling up a speed.....	241
Function.....	239
Increasing/decreasing the speed.....	241
Route-based speed adaptation.....	244
Storing a speed.....	241

Active Emergency Stop Assist..... 248**Active headlamps**..... 143**Active Lane Change Assist**

Activating/deactivating.....	254
Function.....	250

Active Lane Keeping Assist

Activating/deactivating.....	270
Function.....	268
Setting the sensitivity.....	271

Active light function..... 143**Active Parking Assist**

Automatic braking function.....	287
Cross traffic warning.....	288
Drive Away Assist.....	287
Exiting a parking space.....	285
Function.....	281
Maneuvering brake function.....	289
Memory Parking Assist.....	290
Parking.....	283
Pausing.....	286

Active Service System PLUS..... 362**Active Speed Limit Assist**..... 243**Active Steering Assist**

Activating/deactivating.....	248
Active Emergency Stop Assist.....	248
Active Lane Change Assist.....	250
Function.....	246

Active Stop-and-Go Assist..... 246

- Adaptive cruise control**..... 244
- Adaptive Highbeam Assist**
 Activating/deactivating..... 148
- Adaptive Highbeam Assist Plus**
 Activating/deactivating..... 149
- Additives**
 Engine oil..... 444
 Fuel..... 444
- After-sales service**..... 362
- Air bag**
 Center air bag (driver's seat backrest)..... 57
 Front air bag..... 57
 Inflating..... 51
 Overview..... 57
 PASSENGER AIR BAG indicator lamp..... 45
 Warning lamp..... 43
- Air conditioning menu**
 Air distribution..... 163
 Calling up..... 162
 Climate control..... 163
 Front air conditioning..... 162
 Ionization..... 165
 Rear passenger compartment climate control..... 164
- Air distribution**
 Adjusting..... 159, 160, 163
- Air inlet**..... 370
- Air pressure**..... 406
- Air vents**
 Adjusting..... 171
- Air/water duct**..... 370
- Airflow**
 Adjusting..... 159, 160
- Alarm system**..... 99
- All-wheel drive**..... 201
- Alternative route**..... 336
- Ambient lighting**..... 151
- AMG TRACK PACE**
 Configuring..... 328
 Drag Race..... 326
 Function..... 324
 Telemetry display..... 327
 Track Race..... 324
- Animals**..... 53
- Anti-collision**
 Drive Away Assist..... 287
- Anti-lock braking system**..... 231
- Anti-theft alarm system**..... 99
- Anti-theft protection**
 Immobilizer..... 98
- Anticipatory operating-mode strategy,**
 Route-based..... 192
- Apps, Mercedes me**
 Mercedes me calls..... 347
 Mercedes me connect..... 350
- Ashtray**
 Using..... 134
- Assistance system**..... 230
- ASSYST PLUS**
 Battery disconnection periods..... 363
 Service interval display..... 362
 Service requirements..... 362
- ATA**
 Deactivating the alarm..... 100
 Function..... 99
 Interior protection..... 101
 Interior protection function..... 101
 Tow-away alarm function..... 100
 Tow-away protection..... 100









- ATTENTION ASSIST**
 Function..... 235
 Setting..... 237
- Attention assistant**..... 235
- Authorized Mercedes-Benz Service Center**..... 31
- Authorized workshop**..... 31
- Automatic car wash**..... 370
- Automatic car wash mode**..... 372
- Automatic climate control**..... 163
- Automatic distance control**..... 239
- Automatic driving lights**..... 141
- Automatic emergency call**..... 354
- Automatic engine start/stop**..... 185
- Automatic front passenger air bag shutoff**
 Function..... 48
 Information (child restraint system on
 the front passenger seat)..... 62
 PASSENGER AIR BAG indicator lamp..... 45
- Automatic lane change**
 Active Lane Change Assist..... 250
- Automatic measures after an accident**..... 50
- Automatic mirror folding function**..... 158
- Automatic seat adjustment**..... 110
- Automatic transmission**
 DIRECT SELECT lever..... 196
 Drive programs..... 192
 DYNAMIC SELECT button..... 192
 Engages neutral..... 197
 Engaging drive position..... 199
 Engaging reverse gear..... 197
 Kickdown..... 200
 Manual gear shifting..... 199
 Oil temperature (driver's display)..... 298
 Selecting park position..... 198
 Steering wheel paddle shifters..... 199
 Switching gears..... 196
 Transmission position display..... 196
 Transmission positions..... 196
- Autonomous braking**..... 255
- B**
- Bad weather light**..... 144
- Bag hook**..... 128
- BAS**..... 231
- Basic information**..... 40
- Battery**
 High-voltage battery..... 391
- Battery (12 V battery)**
 Charging..... 394
 Notes..... 389
 Notes (starting assistance and charging)..... 392
 Replacing..... 395
 Starting assistance..... 394
- Battery (48 V)**
 Notes..... 390
- Battery (starter battery)**
 charging, Remote Online..... 178
- Battery operation**..... 172
- Belt**
 Fastening..... 43
 Notes on wearing correctly..... 42
 Releasing..... 56
 To adjust the height..... 43
- Blind Spot Assist**
 Activating/deactivating..... 268
 Function..... 264



































- Bluetooth®**
 Connecting a mobile phone..... 346
- Boost pressure, current (driver's display).....** 298
- Brake Assist**
 Active Brake Assist..... 255
 Brake Assist System..... 231
- Brake Assist System.....** 231
- Brake disks.....** 179
- Brake fluid.....** 445
- Brake force distribution.....** 233
- Brake pads.....** 179
- Brakes**
 ABS (Anti-lock Braking System)..... 231
 Active Brake Assist..... 255
 BAS (Brake Assist System)..... 231
 Driving tips..... 181
 EBD (Electronic Brakeforce Distribution)..... 233
 Electric parking brake..... 225
 Handbrake..... 225
 HOLD function..... 234
 Limited braking effect (salt-treated roads)..... 181
 New/replaced brake pads/brake discs.. 179
 Notes on breaking in a new vehicle..... 179
 Parking brake..... 225
 Post-collision brake..... 50, 51
 Recuperation..... 188
- Braking assistance**
 Active Brake Assist..... 255
 Brake Assist System..... 231
- Breakdown**
 Changing a wheel..... 429
 Flat tire..... 382
 Overview of aids..... 18
 Tow-starting..... 401
 Towing methods..... 398
 Transporting the vehicle..... 399
- Breakdown (Roadside Assistance).....** 25
- C**
- Calling the customer center for Mercedes-Benz.....** 347
- Calls**
 Mercedes me..... 347
 Telephone menu..... 346
 Using overhead control panel..... 347
- Camera**
 360° camera..... 273
 Button..... 277
 Care..... 375
 Cleaning..... 375
 Function..... 273
 Information..... 229
 Opening the camera cover (rear view camera)..... 277
 Rear view camera..... 271
 Select view..... 277
- Car key.....** 73
- Car wash**
 Automatic car wash..... 370
 Automatic car wash mode..... 371
 Power washer..... 373
 Washing by hand..... 373
- Car-to-X-Communication**
 Display on map..... 339
- Care**
 Air/water duct..... 370
 Automatic car wash..... 370
 Automatic car wash mode..... 371
 Camera..... 375



































- Decorative foil..... 374
 Display..... 377
 Exterior lighting..... 375
 Genuine wood/trim elements..... 377
 Head-up display..... 377
 Headliner..... 377
 Paint..... 373
 Plastic trim..... 377
 Power washer..... 373
 Seat belt..... 377
 Steering wheel..... 377
 Vehicle interior..... 377
 Vehicle parts..... 375
 Vehicle socket for the high-voltage battery..... 375
 Washing by hand..... 373
 Wheels/rims..... 375
- Care of the headliner**..... 377
Care of the plastic trim..... 377
Care of the steering wheel..... 377
Caring for rims..... 375
Center air bag (driver's seat backrest)
 Inflating..... 51
 Information..... 57
- Central display**..... 309
Central locking system
 Button..... 80
 SmartKey..... 74
Change of address..... 25
Change of ownership..... 25
Changing a wheel
 Preparation..... 429
 Raising the vehicle..... 430
Charge level display..... 219
Charge level/charge display..... 219
Charging
 12 V battery..... 394
 At time of departure..... 329
 Charge level display..... 219
 Charging cable control panel..... 210
 Charging station, mode 3..... 209
 Configuring weekly profile..... 329
 Emergency release of the socket flap..... 219
 Ending the charging process (alternating current, mode 2/3)..... 215
 Ending the charging process (direct current, mode 4)..... 218
 Indicator lamps on vehicle socket..... 212
 Mains socket, mode 2..... 208
 Maximum charging current (mains socket)..... 210
 Notes on charging the high-voltage battery..... 204
 Notes on the high-voltage battery..... 391
 Rapid charging station, mode 4..... 209
 Recuperation..... 188
 Starting the charging process (alternating current, mode 2/3)..... 213
 Starting the charging process (direct current, mode 4)..... 216
 Stowing the charging cable..... 206
 USB port..... 122, 136
 Wallbox, mode 3..... 209
 Wirelessly charging a mobile phone..... 137
- Charging cable**
 Control panel..... 210
 Stowing..... 206
Charging settings..... 329
Checking the coolant level..... 369
Child safety lock
 Rear door..... 70













- Side windows (rear passenger compartment)..... 72
- Child seat**
- Adjusting the vehicle seat..... 64
 - Basic instructions..... 58
 - Front passenger seat..... 62
 - Installing ISOFIX..... 67
 - Rearward-facing..... 64
 - Risks/dangers..... 60
 - Securing on the rear seat with the seat belt..... 70
 - Securing to the front passenger seat with the seat belt..... 70
 - The most important information in brief... 58
 - Top Tether..... 68
- Children**
- Avoiding dangers in the vehicle..... 60
 - Basic instructions..... 58
 - Special seat belt retractor..... 66
- Chock**..... 428, 429
- City lighting**..... 144
- Clean varnish**..... 373
- Cleaning**
- Air/water duct..... 370
 - Automatic car wash..... 370
 - Automatic car wash mode..... 371
 - Camera..... 375
 - Decorative foil..... 374
 - Genuine wood/trim elements..... 377
 - Paint..... 373
 - Power washer..... 373
 - Sensors..... 375
 - Vehicle interior..... 377
 - Vehicle parts..... 375
 - Vehicle socket for the high-voltage battery..... 375
 - Washing by hand..... 373
- Cleaning carpet**..... 377
- Cleaning the seat cover**..... 377
- Climate control, Air conditioning system**
- Activating/deactivating..... 161
 - Activating/deactivating (rear operating unit)..... 162
 - Activating/deactivating the A/C function (control panel)..... 162
 - Activating/deactivating the A/C function (MBUX)..... 163
 - Adjusting..... 162
 - Air conditioning menu..... 162
 - Air distribution..... 159, 160
 - Air vents (front)..... 171
 - Air vents (rear passenger compartment)..... 171
 - Airflow..... 159, 160
 - Automatic control..... 163
 - Defrosting a window..... 162
 - Defrosting windows..... 164
 - Demisting the windshield..... 159, 160
 - Filling capacity for refrigerant and PAG oil..... 448
 - Fine particle status display..... 162
 - Fragrance system..... 165
 - Immediate pre-entry climate control..... 170
 - Inserting/removing the flacon (fragrance system)..... 165
 - Ionization..... 165
 - Notes..... 159
 - Operating unit..... 159, 160
 - Pre-entry climate control for departure time..... 168
 - Pre-entry climate control when the vehicle is unlocked..... 166
 - Rear passenger compartment operating unit..... 160

- Rear window heating..... 159, 160
 Refrigerant..... 447
 Residual heat..... 164
 Switching air-recirculation mode
 on/off..... 164
 Synchronization function..... 164
 Temperature..... 159, 160
 Ventilation with comfort opening..... 92
- COC papers, CERTIFICATE OF CONFORM-
 ITY**..... 437
- Cockpit**
 Instrument panel..... 6, 8
- Coffee cup symbol**..... 235
- Collision detection (parked vehicle)**
 Setting..... 227
- Combination switch**
 Lights..... 141
 Windshield wipers..... 152
- Commuter route**..... 336
- Components relevant to radio regulation**
 Declaration of conformity..... 30
- Composition of the tire**..... 420
- Control elements:**..... 23
- Convenience closing feature**..... 92
- Convenience opening**..... 92
- Coolant**
 Capacity..... 446
 Notes..... 445
- Cooling**..... 159, 160
- Copyright**
 License..... 39
- Copyrights**
 Trademarks..... 39
- Cornering light function**..... 143
- Correct use**..... 32
- Cover**..... 93
- Cross traffic (warning)**..... 288
- Crosswind Assist**..... 233
- Cruise control**
 Activating/deactivating..... 237
 Calling up a speed..... 237
 Function..... 237
 Requirements:..... 237
 Setting a speed..... 237
 Storing a speed..... 237
- Customer Assistance Center (CAC)**..... 33
- D**
- Damage**
 Limited protection..... 53
- Dashcam**
 Notes..... 341
 Selecting a USB device..... 342
 Starting/stopping an individual
 recording..... 343
 Starting/stopping loop recording..... 342
- Data processing in the vehicle**..... 34
- Data protection rights**..... 37
- Data storage**
 Data protection rights..... 37
 Electronic control units..... 34
 Event Data Recorder..... 38
 MBUX multimedia system/Mercedes
 me connect..... 38
 Online services..... 37
- Daytime running lamps, Daytime running
 lamp mode**
 Activating/deactivating..... 150

- Deactivating the alarm..... 100
- Dealership..... 31
- Declaration of conformity
 Components relevant to radio regulation.. 30
- Decorative foil..... 374
- Definitions
 Tires and loading..... 423
- Defrost function..... 162
- Deployed components
 Limited protection..... 53
- Deployment situations..... 51
- Destination entry..... 335
- Detecting inattentiveness..... 235
- Diagnostics connection..... 30
- DIGITAL LIGHT**
 Active headlamps..... 143
 Adaptive Highbeam Assist..... 147
 Adaptive Highbeam Assist Plus..... 148
 Assistance functions..... 145
 Bad weather light..... 144
 City lighting..... 144
 Cornering light function..... 143
- Dynamic low beam..... 143
- Extended range fog lamps..... 144
- Highway mode..... 144
- Overview..... 143
- Topographical compensation..... 144
- Digital Operator's Manual**..... 20
- Digital Vehicle Key**
 Problem..... 79
 Starting the vehicle..... 177
 Unlocking/locking the vehicle..... 77
- Dinghy towing**
 Pulling/towing..... 294
- DIRECT SELECT lever**
 Automatic transmission..... 196
 Engages neutral..... 197
 Engaging drive position..... 199
 Engaging park position automatically..... 198
 Engaging reverse gear..... 197
 Function..... 196
 Gearshift recommendation..... 200
 Manual gearshifting..... 199
 Selecting park position..... 198
- Display**
 Care..... 377
- Display (driver's display)**
 Overview of displays..... 301
- Display message**
 Calling up on driver display..... 449
 Notes..... 449
- Display messages**
 --- mph..... 500
 --- mph..... 499
 12 V On-board Electrical System Service Required..... 514
 48 V Battery See Operator's Manual..... 516
 Acoustic Presence Indicator Inoperative..... 465
 Add Washer Fluid..... 476
 ATTENTION ASSIST: Take a Break!..... 498
 Automatic Driving Lights Inoperative..... 460

-  **Battery Overheated Stop!**
Everyone Get Out! Outdoors if Possible..... 468, 516
-  **Brake Immediately**..... 493
-  **Camera View Reduced See Operator's Manual**..... 511
-  **Charger Cable Connected**..... 465
-  **Check Brake Fluid Level**..... 494
-  **Check Coolant Level See Operator's Manual**..... 482
-  **Check Engine Oil Level At Next Refueling (Add 1 Quart)**..... 523
-  **Check Left Low Beam (example)**.. 462
-  **Check Tires**..... 518
-  **Coolant Stop Switch Off Vehicle**... 482
-  **Currently Not Available Charge High-voltage Battery**..... 463
-  **Currently Not Available Charging of the High-voltage Battery Not Completed**..... 463
-  **Currently Unavailable See Operator's Manual**..... 495
-  **Currently Unavailable See Operator's Manual**..... 496
-  **Digital Vehicle Key Charge Device**..... 459
-  **Do Not Leave People or Animals in the Vehicle**..... 454
-  **Don't Forget Your Key**..... 456
-  **Drive Power and Range Reduced See Operator's Manual**..... 470
-  **Engine Oil Level Cannot Be Measured**..... 524
-  **Engine Oil Level Reduce Oil Level**..... 523
-  **Engine Oil Level Stop Switch Off Vehicle**..... 523
-  **Engine Oil Pressure Stop Switch Off Vehicle**..... 524
-  **Front Left Malfunction Service Required (example)**..... 451
-  **Fuel Filler Cap Open**..... 483
-  **Fuel Tank Is Depressurized Ready for Refueling**..... 473
-  **Have High-Voltage System Checked See Operator's Manual**..... 469
-  **Initializing Key Please Wait**..... 456
-  **Initializing Key Please Wait**..... 459
-  **Initiating Emergency Stop**.... 504, 509
-  **Inoperative See Operator's Manual**..... 496
-  **Inoperative See Operator's Manual**..... 497
-  **EBD Inoperative See Operator's Manual**..... 498
-  **Inoperative**..... 514
-  **Key Does Not Belong to Vehicle**... 459
-  **Key Not Detected (red display message)**..... 455

- | | | |
|--|---|---|
|  Key Not Detected (white display message)..... 455 |  Parking Brake See Operator's Manual..... 489 |  Rear Left Backrest Not Latched (example)..... 481 |
|  Key Not Detected Place Digital Vehicle Key in Mobile Phone Cradle..... 457 |  Performance Extremely Limited.... 472 |  Reduce Speed..... 521 |
|  Key Not Detected..... 457 |  Please Correct Tire Pressure..... 519 |  Release Parking Brake..... 492 |
|  Left Window Airbag Malfunction Service Required (example)..... 452 |  Please Wait Charging 48 V Battery..... 517 |  Replace Key Battery..... 454 |
|  Malfunction See Operator's Manual..... 493 |  Please Wait Depressurizing Fuel Tank..... 473 |  Replace SmartKey See Operator's Manual..... 458 |
|  Malfunction See Operator's Manual..... 460 |  Pre-entry Climate Control Available Again via SmartKey after Vehicle Start..... 464 |  Restraint System Malfunction Service Required..... 450 |
|  Malfunction Service Required..... 469 |  Pre-entry Climate Control via SmartKey Currently Not Available. High-voltage Battery Low..... 464 |  Steering Malfunction Drive Carefully Service Required..... 478 |
|  Malfunction Stop..... 494 |  Rear Axle Steering Currently Malfunctioning..... 478 |  Steering Malfunction Increased Physical Effort See Operator's Manual... 478 |
|  Malfunction..... 471 |  Rear Axle Steering Malfunction Service Required..... 479 |  Steering Malfunction Stop Immediately See Operator's Manual..... 477 |
|  Malfunction..... 468 |  Rear Axle Steering Malfunction Stop Immediately..... 479 |  Stop Switch Off Vehicle..... 471 |
|  Obtain a New Key..... 459 | |  Stop Vehicle See Operator's Manual..... 514 |
|  Off..... 500 | |  Stop Vehicle See Operator's Manual..... 516 |
|  Off..... 498 | | |

 Stop Vehicle To Charge the 12 V Battery Do Not Switch Off Vehicle.....	515	AC Charging Inoperative Service Required.....	466	Active Lane Change Assist Inoperative...	505
 Suspended.....	500	Active Blind Spot Assist Currently Unavailable See Operator's Manual.....	507	Active Lane Keeping Assist Currently Unavailable See Operator's Manual.....	508
 Switch Off Lights.....	461	Active Blind Spot Assist Inoperative.....	508	Active Lane Keeping Assist Inoperative...	508
 Switch On Headlights.....	460	Active Brake Assist Functions Currently Limited See Operator's Manual.....	501	Active Lane Keeping Assist Limited Range of Functions See Operator's Manual.....	509
 Switch on vehicle to charge the 12 V battery.....	515	Active Brake Assist Functions Limited See Operator's Manual.....	502	Active Parking Assist and PARKTRONIC Inoperative See Operator's Manual.....	513
 Switch on Vehicle to Release the Parking Brake.....	492	Active Distance Assist Currently Unavailable See Operator's Manual.....	500	Active Parking Assist Limited Availability of Maneuvering Assistance See Operator's Manual.....	513
 Take SmartKey With You.....	458	Active Distance Assist Inoperative.....	501	Active Steering Assist Currently Unavailable Due to Multiple Emergency Stops.....	503
 Temporarily Unavailable Sensors Dirty.....	510	Active Distance Assist Now Available.....	501	Active Steering Assist Currently Unavailable See Operator's Manual.....	502
 Tires Overheated.....	520	Active Emergency Stop Assist Currently Unavailable See Operator's Manual.....	504	Active Steering Assist Inoperative.....	503
 Towing Not Permitted See Operator's Manual.....	465	Active Emergency Stop Assist Inoperative.....	504		
 Warning Tire Malfunction.....	520	Active Lane Change Assist Currently Unavailable See Operator's Manual.....	505		
 Wheel Sensor(s) Missing.....	518				
"Electric" Drive Program Currently Unavailable.....	467				

Active Stop & Go Assist Currently Unavailable See Operator's Manual.....	506	Auxiliary Battery Malfunction (red display message).....	488	Depress Brake to Shift from P.....	483
Active Stop & Go Assist Inoperative See Operator's Manual.....	506	Auxiliary Battery Malfunction (white display message).....	488	Depress Brake to Shift to D or R.....	484
Adaptive Highbeam Assist Currently Unavailable See Operator's Manual.....	462	Blind Spot Assist Currently Unavailable See Operator's Manual.....	507	Depress Brake to Shift to R.....	484
Adaptive Highbeam Assist Inoperative....	462	Blind Spot Assist Inoperative.....	507	DIGITAL LIGHT Functions Limited.....	461
Adaptive Highbeam Assist Plus Currently Unavailable See Operator's Manual.....	461	Cannot Start Vehicle See Operator's Manual.....	470, 474	Do Not Restart Vehicle Service Required.....	469
Adaptive Highbeam Assist Plus Inoperative.....	461	Charging Fault Change Charging Mode See Operator's Manual.....	466	Drive Malfunction Achievable Speed Limited Stop Soon.....	471
Ambient Lighting Warning Support Inoperative.....	479	Check Brake Pads See Operator's Manual.....	495	Drive Malfunction Achievable Speed Severely Limited See Operator's Manual.....	471
Authentication Failed Use Different Authentication Method or Charging Station.....	467	Check Tire and Tire Pressure.....	521	Drive Malfunction Stop Contact Dealer...	487
Automatic Lane Change Currently Unavailable See Operator's Manual.....	505	Check Tire Pressure Then Restart Run Flat Indicator.....	522	Drive Malfunction Stop Restart Vehicle...	487
Automatic Lane Change Inoperative.....	506	Cruise Control Inoperative.....	499	Drive Overheated Drive Carefully.....	487
		Cruise Control Off.....	499	Front Passenger Airbag Disabled See Operator's Manual.....	452
		DC Charging Inoperative Service Required.....	466	Front Passenger Airbag Enabled See Operator's Manual.....	453
				Fuel Reserve.....	483

Function Blocked by Folded Center Backrest.....	481	Occupant Presence Reminder Inoperative.....	454	Risk of Vehicle Rolling Away Apply Parking Brake When Parking.....	485
Hazard Warning Light Malfunction.....	463	Only Electric Drive Available Power Limited.....	467	Risk of Vehicle Rolling Away Driver's Door Open Position P Not Selected.....	485
Head-up Display Brightness Currently Reduced See Operator's Manual.....	477	PARKTRONIC Inoperative See Operator's Manual.....	512	Risk of Vehicle Rolling Away N Activated Manually No Automatic Change to P.....	485
Head-up Display Currently Unavailable See Operator's Manual.....	476	Place the Key in the Marked Space See Operator's Manual.....	456	Run Flat Indicator Inoperative.....	522
Head-up Display Inoperative.....	476	PRE-SAFE Inoperative See Operator's Manual.....	512	Searching for Key in Stowage Tray or Digital Vehicle Key in Inductive Charging Bracket... See Operator's Manual.....	456
High-Voltage Battery Fault No Start in Approx. XXX mi Service Required (red display message).....	472	PRE-SAFE PLUS Inoperative See Operator's Manual.....	512	Service Required Apply Parking Brake to Park.....	484
High-Voltage Battery Fault No Start in Approx. XXX mi Service Required (yellow display message).....	472	PRE-SAFE Pulse Side Inoperative See Operator's Manual.....	512	Service Required Do Not Change Transmission Position.....	469, 487
High-Voltage Battery Fault Do Not Restart Service Required.....	473	Preparing Drive System.....	468	Shift to P Only When Vehicle Is Stationary.....	483
N Automatically Activated Please Shift to Transmission Position Again.....	486	Reduced Drive System Performance See Operator's Manual.....	468	Starting Possible Again.....	517
Not Possible to Unlock Charging Cable See Operator's Manual.....	465	Reversing Not Possible Service Required.....	486	Tire Pressure Monitor Currently Unavailable.....	517

- Tire Pressure Monitor Inoperative..... 518
- Tire Pressure Monitor Inoperative Tire Pressure Sensors Missing..... 518
- To Deselect P or N Depress Brake and Start Vehicle..... 484
- To shift to N, hold selector lever longer in N position..... 486
- To Switch Off Vehicle Press and Hold Start/Stop Button for at Least 3 Seconds or Press 3 Times..... 481
- Traffic Sign Assist Currently Unavailable See Operator's Manual..... 499
- Traffic Sign Assist Inoperative..... 499
- Transmission Malfunction Stop..... 486
- Vehicle Currently Not Charging... Charging Station Fault..... 466
- Vehicle Ready to Drive Shutdown Occurs When Locked or After a Few Minutes..... 475
- Vehicle Ready to Drive Shutdown Occurs When Locked or Automatically in XX Mins..... 475
- Windshield Wiper Malfunction..... 476
- Displaying road names/house numbers**..... 336
- Distance control**..... 239
- Distance warning**..... 255
- DISTRONIC**..... 239
- Door**
- Child safety lock (rear door)..... 70
 - Emergency key..... 82
 - Opening (from the inside)..... 79
 - Unlocking (inside)..... 79
- Door operating unit**
- Function seat..... 16
- DOT, Tire Identification Number (TIN)**..... 418
- Drag Race**..... 326
- Drinking and driving**..... 181
- Drinks holder, Cup holder**..... 131
- Drive Away Assist**..... 287
- Drive position**..... 199
- Drive program display**..... 194
- Drive programs**
- Selecting..... 194
- Driver display**
- Identifying malfunctions..... 295
- Driver's display, Instrument cluster**
- 48 V on-board electrical system..... 300
 - Head-up display..... 298
 - Menus..... 297
 - Notes..... 295
 - Operating..... 296
 - Service due date..... 362
 - Status displays..... 301
 - Warning/indicator lamps..... 10, 525
- Driver's seat**
- Adjusting electrically..... 105
 - Easy entry and exit feature..... 116
 - Manually adjusting..... 103
 - Seat heating..... 112
- Driving safety system**
- ABS (Anti-lock Braking System)..... 231
 - Active Brake Assist..... 255
 - Active Lane Change Assist..... 250
 - Active Steering Assist..... 246

- ATTENTION ASSIST..... 235
 BAS (Brake Assist System)..... 231
 Blind Spot Assist / Active Blind Spot Assist..... 264
 Cameras..... 229
 Cruise control..... 237
 EBD (Electronic Brakeforce Distribution)..... 233
 ESP® (Electronic Stability Program)..... 232
 Hill Start Assist..... 235
 HOLD function..... 234
 Overview..... 230
 Radar and ultrasonic sensors..... 229
 STEER CONTROL..... 233
 Traffic Sign Assist..... 260
 Your responsibility..... 229
- Driving system**..... 230
- Driving tips**
- Drinking and driving..... 181
 - General driving tips..... 181
 - Notes on breaking in a new vehicle..... 179
 - Optimized acceleration..... 180
 - Rear axle steering..... 184
 - Recuperation..... 188
- Drowsiness detection**..... 235
- Duplicate key**..... 77
- Dynamic handling control system**..... 232
- Dynamic low beam**
- Overview..... 143
- DYNAMIC SELECT**
- Calling up the fuel consumption indicator..... 196
 - Configuring drive program I..... 194
 - Displaying engine data..... 195
 - Displaying vehicle data..... 195
 - Drive program display..... 194
 - Drive programs..... 192
 - Function..... 192
 - Selecting the drive program..... 194
- E**
- E10**..... 443
- E25**..... 443
- Easy entry feature**
- Adjusting..... 117
 - Function..... 116
- Easy exit feature**
- Adjusting..... 117
- Function..... 116
- EASY-PACK trunk box**
- Care..... 377
- EBD, Electronic Brakeforce Distribution**..... 233
- ECO Assist**
- 48 V on-board electrical system..... 187
 - Activating/deactivating..... 191
 - Plug-in hybrid..... 190
- ECO display**..... 186
- ECO start/stop button**
- Automatic engine start/stop..... 186
- ECO start/stop function**
- Automatic engine start..... 185
 - Automatic engine stop..... 185
 - Function..... 185
 - Switching off/on..... 186
- Electric drive**..... 172
- Electric parking brake**
- Applying automatically..... 225
 - Emergency braking..... 226
 - Manually applying/releasing..... 226
 - Releasing automatically..... 226
- Electrical fuses**..... 402

- Electronic Stability Program**..... 232
- Emergency**
- First-aid kit (soft sided)..... 381
 - Overview of aids..... 18
 - Reflective safety vest..... 380
 - Warning triangle..... 381
- Emergency braking**
- Active Brake Assist..... 255
 - Brake Assist System..... 231
 - Carrying out..... 226
 - Electric parking brake/handbrake..... 225
- Emergency key**
- Door..... 82
- Emergency operation mode**
- Starting the vehicle..... 178
- Emergency release**
- Socket flap..... 219
 - Trunk lid (from inside)..... 90
- Emergency shutoff (high-voltage on-board electrical system)**..... 174
- Emergency stop assistant**..... 248
- Emergency Tensioning Devices**
- Inflating..... 51
- Energy flow display**
- Function/notes..... 330
- Engine**
- Emergency operation mode..... 178
 - Emergency start..... 401
 - Engine number..... 439
 - Jump-starting..... 392
 - Parking (start/stop button)..... 220
 - Starting (Digital Vehicle Key)..... 177
- Engine data**
- Displaying..... 195
 - DYNAMIC SELECT..... 195
- Engine number**..... 439
- Engine oil, Oil**
- Additives..... 444
 - Capacity..... 445
 - Checking the oil level using the driver display..... 367
 - MB-Freigabe or MB-Approval..... 445
 - Quality..... 445
 - Refilling..... 367
 - Temperature (driver's display)..... 298
- Engine oil temperature (driver's display)**..... 298
- Engine output, current (driver's display)**..... 298
- Environmentally friendly driving**..... 21
- ESC, Electronic Stability Control**..... 232
- ESP®**
- Activating/deactivating..... 233
 - Crosswind Assist..... 233
 - Function..... 232
- Event Data Recorder**..... 38
- Exit warning**
- Blind Spot Assist / Active Blind Spot Assist..... 264
- Exiting a parking space**
- Active Parking Assist..... 281
 - Drive Away Assist..... 287
 - PARKTRONIC..... 277
- Exterior lighting**
- Care..... 375
- Exterior mirrors**
- Parking position..... 157
- F**
- Factory settings**
- MBUX reset function..... 323

- Film coverings**
 On camera/sensors..... 229
- Fine particle status display**..... 162
- First aid**
 First-aid kit (soft sided)..... 381
- First-aid kit (soft sided)**..... 381
- Fitting**
 Snow chains..... 406
- Fitting accessories**
 Limited protection..... 53
- Flacon**..... 165
- Flat tire**
 Changing a wheel..... 429
 MOExtended..... 383
 Notes..... 382
 TIREFIT kit..... 384
- Flat towing**
 Pulling/towing..... 294
- Floor mats**..... 138
- Fog lamp**..... 141
- Fog light (extended range)**..... 144
- Foil covering**
 Radar and ultrasonic sensors..... 229
- Fragrance system**
 Adjusting..... 165
 Inserting/removing the facon..... 165
 Perfume vial..... 165
- Free software**..... 39
- Frequencies**
 Two-way radio..... 438
- Front air bag**
 Inflating..... 51
- Front headlamps**..... 140
- Front passenger air bag**
 Disabling/enabling..... 47
- Front passenger air bag shutoff, PASSENGER AIR BAG OFF**
 Information (child restraint system on the front passenger seat)..... 62
- Front passenger seat**
 Adjusting electrically..... 105
 Manually adjusting..... 103
- Fuel**
 Additives..... 444
- Depressurize the fuel tank (plug-in hybrid with gasoline engine)..... 204
 E10..... 443
 E25..... 443
 gasoline..... 443
 Gasoline quality..... 443
 Refilling..... 201
 Reserve..... 444
 sulfur content..... 443
 Tank capacity..... 444
- Fuel consumption indicator**..... 196
- Fuel reserve**..... 444
- Function in the event of an accident**..... 52
- Function seat**..... 16
- Fuses**
 Cockpit..... 403
 Engine compartment..... 402
 Fuse assignment diagram..... 402
 Notes..... 402
 Passenger footwell..... 404
 Trunk..... 404
- G**
- G-meter, Accelerometer**..... 298

Garage door opener	
Clearing the memory.....	224
Opening/closing a door.....	224
Problem.....	224
Garage door openers	
Programming buttons.....	222
Synchronizing the rolling code.....	224
gasoline	443
Gearshift	
DIRECT SELECT lever.....	196
Manual.....	199
General driving tips	181
Genuine parts	22
Glide mode	200
Glove box	
Locking/unlocking.....	124
Grab handles	102
H	
Handbrake	225
Handling characteristics	
Unusual.....	405

HANDS-FREE ACCESS	87
Haptic accelerator pedal, Pressure point	192
Hazard warning lights	142
Hazard warnings	
Car-to-X-Communication.....	339
Head restraint	
Adjusting (rear passenger compartment).....	109
Adjusting manually (front, 2-way).....	108
Adjusting manually (front, 4-way).....	109
Removing/installing (rear passenger compartment).....	110
Head-up display	
Care.....	377
Function.....	298
Memory function.....	119
Operating.....	299
Switching on/off.....	300
Headlamp flashing	141
Headlamp range control	144
Headlamps	140
Heating	
Activating/deactivating.....	161

Center console.....	160
Climate control.....	159, 160
Rear window.....	159, 160
Seat.....	112
Steering wheel.....	116

Help call

Mercedes-Benz emergency call system..	354
---------------------------------------	-----

High beam.....

	141
--	-----

High-voltage battery

Charge level display.....	219
Charging at time of departure.....	329
Charging cable control panel.....	210
Charging station, mode 3.....	209
Configuring weekly profile.....	329
Ending the charging process (alternating current, mode 2/3).....	215
Ending the charging process (direct current, mode 4).....	218
Energy flow display.....	331
General notes on charging.....	204
Mains socket, mode 2.....	208
Maximum charging current (mains socket).....	210
Notes.....	391
Rapid charging station, mode 4.....	209

- Recuperation..... 188
 Starting the charging process (alternating current, mode 2/3)..... 213
 Starting the charging process (direct current, mode 4)..... 216
 Stowing the charging cable..... 206
 Wallbox, mode 3..... 209
- High-voltage on-board electrical system**
- Indicator lamps on vehicle socket..... 212
 Manual switch-off..... 174
 Operating safety..... 26
- Highway mode**..... 144
- Hill Start Assist**..... 235
- HOLD function**
- Function..... 234
 Switching on/off..... 234
- Home screen**
- Central display..... 309
- Hood**
- Opening/closing..... 364
- I**
- Identification plate**
- Engine..... 439
 Refrigerant..... 447
 Vehicle..... 439
- Immediate pre-entry climate control**..... 170
- Immobilizer**..... 98
- Incorrect behavior by vehicle occupants**
- Limited protection..... 53
- Indicator/warning lamps**
- Driver's display..... 525
 PASSENGER AIR BAG..... 45
- Individual drive program**
- Configuring..... 194
- Inside rearview mirror**..... 157
- Installing**
- Tires/wheels..... 433
- Instrument panel**
- Cockpit..... 6, 8
- Interior lighting**
- Adjusting..... 150
 Ambient lighting..... 151
- MBUX reading light..... 314
 Switch-off delay time..... 152
- Interior protection**..... 101
- Internet**
- Mercedes me connect..... 350
 Setting up a Wi-Fi hotspot..... 321
- Ionization**..... 165
- ISOFIX child seat anchor**
- Installing..... 67
- J**
- Jack**
- Storage location..... 428, 429
- Jump-start connection**..... 394
- K**
- Key**
- Problem..... 77
 Replacement key..... 77
- KEYLESS-GO**
- Deactivating..... 74
 Locking/unlocking the vehicle..... 80
 Problem..... 81

- Unlocking setting..... 74
- Kickdown**..... 200
- Knee bag**..... 57
- L**
- Lane Change Assist**..... 250
- Lane Keeping Assist**..... 268
- Lane recognition**
 - Active Lane Change Assist..... 250
 - Active Lane Keeping Assist..... 268
- Language**
 - Notes..... 323
 - Setting..... 323
- License plate (front)**..... 29
- License plate assembly (front)**..... 29
- Light switch**..... 140
- Lighting**
 - Dynamic low beam..... 143
 - Interior lighting..... 150
- Lights**
 - Active headlamps..... 143
 - Adaptive Highbeam Assist..... 147
 - Adaptive Highbeam Assist Plus..... 148
 - Assistance functions..... 145
 - Automatic driving lights..... 141
 - Bad weather light..... 144
 - City lighting..... 144
 - Combination switch..... 141
 - Cornering light function..... 143
 - DIGITAL LIGHT..... 143
 - Dynamic low beam..... 143
 - Fog light (extended range)..... 144
 - Hazard warning lights..... 142
 - High beam..... 141
 - Highway mode..... 144
 - Interior lighting..... 150
 - Locator lighting..... 150
 - Reading lamp..... 150
 - Rear fog light..... 141
 - Responsibility for lighting systems..... 140
 - Switch-off delay time..... 150
 - Switching on the daytime running lamps..... 150
 - Topographical compensation..... 144
 - Turn signals..... 141
- Limited Warranty**..... 34
- Live Traffic Information**..... 339
- Load index**
 - Tires..... 420
- Load-bearing capacity**
 - Tires..... 420
- Loading**
 - Bag hook..... 128
 - Definitions..... 423
 - Notes..... 119
 - Roof luggage rack..... 129
 - Tie-down eyes..... 128
- Loading guidelines**..... 119
- Loading information table**..... 413
- Loads**..... 119
- Locator lighting**..... 150
- Locking/unlocking**
 - Automatic locking (MMS)..... 82
 - Digital Vehicle Key..... 77
 - Doors (from the inside)..... 79
 - Emergency key..... 82
 - KEYLESS-GO..... 80
- Loud sound**
 - PRE-SAFE® Sound..... 49

- Low-beam headlamps**
 - Activating/deactivating..... 140
- Lubricants**..... 441
- Luggage**..... 119
- Luggage rack**..... 119
- Lumbar support**..... 107
- M**
- Maintaining safe distance**
 - Active Distance Assist DISTRONIC..... 241
- Maintenance**
 - Vehicle..... 25
- Maintenance Management**
 - Notes..... 363
 - Transferred data..... 363
- Malfunction**
 - Driver display..... 295
 - Restraint system..... 43
- Malfunction message**
 - Driver's display..... 449
- Maneuvering**
 - Drive Away Assist..... 287
 - Maneuvering brake function..... 289
- Maneuvering assistant**
 - Cross traffic warning..... 288
 - Drive Away Assist..... 287
 - Maneuvering brake function..... 289
- Maneuvering brake function**..... 289
- Maneuvering support**..... 288
- Manual gearshifting**
 - Activating/deactivating..... 200
- Map**
 - Displaying online map contents..... 339
 - Displaying weather information..... 339
 - Moving..... 338
 - Selecting the map orientation..... 338
 - Setting the map scale..... 338
- Map functions**..... 338
- Massage programs**..... 111, 112
- Maximum full-stop braking**..... 231
- Maximum permissible load**
 - Calculation example..... 415
 - Determining..... 414
- Maximum tire load**..... 419
- Maximum tire pressure**..... 420
- MBUX**
 - Dashcam..... 341
- MBUX Interior Assistant**
 - Overview..... 312
 - Preselection outside mirrors..... 315
 - Reading light..... 314
 - Search light..... 314
- MBUX multimedia system**
 - Air conditioning menu..... 162
 - Calling up the zero layer..... 307
 - Drive programs..... 194
 - Factory setting..... 323
 - Home screen..... 309
 - Language settings..... 311
 - MBUX Interior Assistant..... 312
 - Media..... 357
 - Memory Park Assist..... 293
 - Mercedes me & Apps..... 352
 - Notes..... 303
 - Operating the zero layer..... 307
 - Overview..... 304
 - Set collision detection..... 227
 - Setting route-based speed adaptation... 245
 - Standby mode function..... 228
 - Steering wheel heater / seat heating.... 116

- Telephone..... 343
- Touchscreen..... 310
- Zero layer..... 304
- MBUX reading light**..... 314
- MBUX search light**..... 314
- MBUX Voice Assistant**
 - Function..... 311
 - Voice prompting..... 311
- Mechanical key**
 - Inserting/removing..... 75
- Media**
 - Overview of functions/symbols..... 357
- Medical aids**..... 32
- Memory function**
 - Head-up display..... 119
 - Outside mirrors..... 119
 - Seat..... 119
 - Steering wheel..... 119
- Memory Parking Assist**
 - Exiting a parking space..... 292
 - Function..... 290
 - Parking..... 291
 - Recording..... 290
- Setting..... 293
- Menus (driver's display)**
 - Notes..... 297
 - Sport..... 298
- Mercedes me App**
 - Activating on-demand features..... 24
- Mercedes me Apps**..... 352
- Mercedes me calls**
 - Arranging a service appointment..... 349
 - Calling the Mercedes-Benz customer center after automatic accident/breakdown detection..... 348
 - Calls via the overhead control panel..... 347
 - Information..... 347
 - Mercedes-Benz customer center..... 347
 - Transferred data..... 349
- Mercedes me connect**
 - Accident/Breakdown Management..... 351
 - Information..... 350
 - Transferred data..... 352
- Mercedes-AMG vehicles, Notes**..... 172
- Mercedes-Benz emergency call system, Emergency call**
 - Automatic emergency call..... 354
 - Data transfer..... 356
 - Information..... 353
 - Manual emergency call..... 355
 - Overview..... 354
- Mercedes-Benz GenuineParts**..... 22
- Message memory**..... 449
- Mirror heater**..... 166
- Mirrors**
 - Mirror folding function..... 158
 - Outside mirrors..... 155
 - Rearview mirror..... 157
- Mobile phone**
 - Notes on wireless charging..... 137
 - Wireless charging (front)..... 138
- Model type**..... 439
- Modification**
 - Limited protection..... 53
- MOExtended tires, Run-flat tires**..... 383

N**Navigation**

Activating.....	332
Destination entry.....	335
Notes.....	332
Overview.....	332

Near-field communication (NFC)

Locking/unlocking the vehicle (Digital Vehicle Key).....	77
Starting the vehicle (Digital Vehicle Key).....	177

Neutral..... 197**Non-operational time**

Activating/deactivating standby mode...	229
---	-----

Notes on breaking in a new vehicle..... 179**O****Objects in the vehicle interior**

Limited protection.....	53
-------------------------	----

Occupant presence reminder

Activating/deactivating.....	72
Function.....	72

Occupant safety

Air bag.....	57
Basic information.....	40
Child seat.....	58
Information on the child restraint system.....	47
Information on the correct seat position...	41
Occupant presence reminder.....	72
Pets in the vehicle.....	53
PRE-SAFE®.....	49

Off-road menu

Overview.....	331
Setting.....	331

On-board diagnostics interface..... 30**On-board electronics**

Two-way radios.....	437
---------------------	-----

On-demand feature..... 24**Online services**..... 37**Open Source Software**..... 39**Opening the trunk lid using your foot**

HANDS-FREE ACCESS.....	87
------------------------	----

Opening/closing a door..... 224**Opening/closing a garage door**..... 224**Operating fluids**

Additives.....	444
Brake fluid.....	445
coolant.....	445
Engine oil.....	444
gasoline.....	443
Notes.....	441
Refrigerant (air conditioning system).....	447
Windshield washer fluid.....	446

Operating safety

48 V on-board electrical system.....	26
High-voltage on-board electrical system...	26

Operator's manual..... 23**Operator's Manual digital**..... 20**Outside mirrors**

Automatic anti-glare mode.....	157
Automatic mirror folding function.....	158
Blind Spot Assist / Active Blind Spot Assist.....	264
Folding in/out.....	155
Memory function.....	119
Preselection MBUX.....	315
Setting.....	155
Warning lamp.....	264

- Overhead control panel..... 14
- P**
- Paddle shifters**
Steering wheel paddle shifters..... 199
- Paint code**..... 439
- Panic alarm, Alarm**
Activating/deactivating..... 74
- Park position**
DIRECT SELECT lever..... 196
- Parking**
Active Parking Assist..... 281
PARKTRONIC..... 277
- Parking Assist**
Activating/deactivating..... 289
Active Parking Assist..... 281
Memory Parking Assist..... 290
PARKTRONIC..... 277
- Parking Assist PARKTRONIC**
Activating/deactivating..... 280
Adjusting warning tones..... 281
Function..... 277
- Parking assistance systems**
Active Parking Assist..... 281
Drive Away Assist..... 287
Maneuvering brake function..... 289
Memory Parking Assist..... 290
PARKTRONIC..... 277
- Parking brake**..... 225
- Parking for an extended period**..... 228
- Parking lamps**..... 140
- Parking lights**..... 140
- Parking position**
Exterior mirrors..... 157
Storing the position of the front-passenger outside mirror using reverse gear..... 158
- PARKTRONIC**..... 277
- PASSENGER AIR BAG**
Status display, front passenger air bag.... 45
- Payload**
Calculation example..... 415
Determining the maximum..... 414
- Permitted towing methods**
Overview..... 396, 397
- Personalization**..... 315
- Pets in the vehicle**..... 53
- Plug-in hybrid operation**
Charging cable control panel..... 210
Charging the high-voltage battery at a rapid charging station (mode 4)..... 209
Ending the charging process (alternating current, mode 2/3)..... 215
Ending the charging process (direct current, mode 4)..... 218
Function of the recuperative brake system..... 188
Functions of the energy flow display..... 330
Haptic accelerator pedal..... 192
Indicator lamps on vehicle socket..... 212
Manually disconnecting the high-voltage on-board electrical system..... 174
Maximum charging current (mains socket)..... 210
Notes on charging (charging station, mode 3)..... 209
Notes on charging (mains socket, mode 2)..... 208
Notes on charging (wallbox, mode 3)..... 209
Notes on plug-in hybrid operation..... 172

- Operating safety..... 26
 Power meter..... 300
 Route-based operating-mode strategy.... 192
 Sets recuperation..... 189
 Starting the charging process (alternating current, mode 2/3)..... 213
 Starting the charging process (direct current, mode 4)..... 216
 Stowing the charging cable..... 206
- Post-collision brake**..... 51
- Power closing function**
 Trunk lid..... 85
- Power supply**
 Start/stop button..... 175
 Switching on (start/stop button)..... 175
- Power washer**..... 373
- Pre-entry climate control**
 activating/deactivating for departure time..... 169
 At time of departure..... 168
 For departure time..... 169
 immediate..... 170
 When vehicle is unlocked..... 166, 167
- Pre-heating**..... 166
- PRE-SAFE®**, Anticipatory occupant protection
 Function..... 49
 PRE-SAFE® Sound..... 49
 Reverting measures..... 49
- PRE-SAFE® Impulse Side**
 Function..... 50
 Inflating..... 51
- PRE-SAFE® PLUS**
 Backing up measures..... 49
 Function..... 49
- Preventative occupant protection system**..... 49
- Profile**..... 315
- Programs**..... 192
- Protection**
 Limited..... 53
- Protection against collision**
 Maneuvering brake function..... 289
- Protection of the environment**
 Driving style..... 21
- Pulling away**
 Drive Away Assist..... 287
 Hill Start Assist..... 235
- Optimized acceleration..... 180
- Q**
- QR code rescue card**..... 34
- Qualified specialist workshop**..... 31
- R**
- Radar and ultrasonic sensors**..... 229
- Radio**..... 359
- Radio regulations**
 Regulatory radio identification..... 439
- Rain closing function**
 Sliding sunroof..... 96
- Rain sensor**
 Sliding sunroof..... 96
 Windshield wipers..... 152
- Reading lamp**
 Interior lighting..... 150
- Rear axle steering**..... 184
- Rear door (child safety lock)**
 Securing..... 70
- Rear fog light**..... 141

- Rear passenger compartment climate control**..... 164
- Rear passenger compartment seat belt**
Status display..... 45
- Rear view camera**
360° Camera..... 271
Function..... 271
Opening the camera cover..... 277
- Rear window**
Roller sunblind..... 98
- Rear window heater**..... 159
- Rear window heating**..... 159, 160
- Rearview mirror**
Automatic anti-glare mode..... 157
- Rearward-facing child seat**
Information..... 64
- Recuperation**
Function..... 188
Setting..... 189
- Reflective safety vest**..... 380
- Refrigerant**..... 447
- Refueling**
depressurize the fuel tank (plug-in hybrid with gasoline engine)..... 204
Fuel..... 201
Refueling the vehicle..... 201
- Regulatory radio information**
Specific absorption rate..... 439
- Remote Online**
Charging the starter battery..... 178
Cooling/heating the vehicle interior..... 178
Starting the vehicle..... 179
- Replacement key**..... 77
- Reporting safety defects**..... 33
- Reserve**
Fuel..... 444
- Resetting**
MBUX reset function..... 323
- Residual heat**..... 164
- Responsibility**
Driving safety systems..... 229
- Restraint system**
Basic information..... 40
Basic instructions for children..... 58
Deployment situations..... 51
Functionality..... 43
Information on function..... 52
Information on the correct seat position... 41
Limited protection..... 53
Malfunction..... 43
Protection..... 41
Self-test..... 43
Warning lamp..... 43
- Reverse gear**
DIRECT SELECT lever..... 196
- Roadside Assistance (breakdown)**..... 25
- Roll away protection**..... 234
- Roller sunblind**
Rear window..... 98
Side windows..... 97
Sliding sunroof..... 93
- Roof luggage rack**
Loading..... 129
Securing..... 129
- Route**
Alternative route..... 336
Calculating..... 336
Commuter route..... 336

- Navigation..... 332
- Selecting a type..... 336
- Route guidance with augmented reality**
- Activating..... 336
- Displaying road names/house numbers..... 336
- Switching video on or off..... 336
- Route-based operating-mode strategy**
- Function..... 192
- Route-based speed adaptation**
- Function..... 244
- Setting..... 245
- Run-flat characteristics**..... 383
- S**
- Safety system**..... 230
- Seat, Front seat, Through-loading feature**
- Adjusting electrically..... 105
- Automatic adjustment..... 110
- Center air bag (driver's seat backrest)..... 57
- Configuring settings..... 110
- Correct driver's seat position..... 102
- Folding back the backrest (rear passenger compartment)..... 127
- Folding backrest forward (rear)..... 125
- Locking the backrest (rear passenger compartment)..... 128
- Lumbar support..... 107
- Manually adjusting..... 103
- Massage programs..... 111
- Memory function..... 119
- Resetting settings (massage programs).. 112
- Settings..... 16
- Side impact air bag..... 57
- Workout programs..... 111
- Seat belt**
- Automatic tightening..... 50
- Care..... 377
- Rear passenger compartment seat belt status display..... 45
- Warning lamp..... 44
- Seat belt adjustment**
- Activating/deactivating..... 50
- Function..... 50
- Seat belt warning**..... 44
- Seat belts**
- Activating/deactivating seat belt adjustment..... 50
- Fastening..... 43
- Notes on wearing correctly..... 42
- Releasing..... 56
- To adjust the height..... 43
- Seat heating**
- Activating/deactivating..... 112
- Seat ventilation**
- Activating/deactivating..... 113
- Selecting a gear**..... 199
- Selector lever**..... 196
- Self-test**
- Automatic front passenger air bag shut off..... 45
- Restraint system..... 43
- Sensors**
- Cleaning..... 375
- Information..... 229
- Service**..... 362
- Service center**..... 31
- Service due date**..... 362
- Service interval display**..... 362

- Shifting**
 Automatic transmission..... 199
 Gearshift recommendation..... 200
 Manual..... 199
 Steering wheel paddle shifters..... 199
- Shortening the braking distance**
 Brake Assist System..... 231
- Side impact air bag**..... 57
- Side window**
 Window films..... 375
- Side windows**
 Child safety lock (rear passenger compartment)..... 72
 Closing with SmartKey..... 92
 Convenience closing feature..... 92
 Convenience opening..... 92
 Opening with the SmartKey..... 92
 Opening/closing..... 90
 Problem..... 93
 Roller sunblind..... 97
- Size designation**
 Tires..... 420
- Skid chains**..... 406
- Sliding sunroof, Panorama roof with power tilt/sliding panel**
 Automatic functions..... 96
 Closing with SmartKey..... 92
 Opening with the SmartKey..... 92
 Opening/closing..... 93
 Problem..... 96
 Rain closing function..... 96
- SmartKey**
 Acoustic locking verification signal..... 74
 Battery..... 75
 Deactivating a function..... 74
 Function..... 73
 Key ring attachment..... 75
 Mechanical key..... 75
 Panic alarm..... 74
 Power consumption..... 74
 Unlocking setting..... 74
- Smartphone Integration, iPhone®**
 Android Auto..... 352
 Apple CarPlay®..... 352
- Snow chains**..... 406
- Socket**
 12 V..... 135
 115 V (rear passenger compartment)..... 135
- Socket flap**..... 204
- Software update**..... 320
- SOS button**..... 347
- Sound**
 Menu..... 361
 PRE-SAFE® Sound..... 49
 Wheels/tires..... 405
- Sound settings**..... 361
- Spare parts**..... 22
- Spare wheel, Emergency spare wheel**..... 435
- Special seat belt retractor**..... 66
- Specialist workshop**..... 31
- Specific absorption rate (SAR)**..... 439
- Speed**
 Save, cruise control..... 241
 Save, DISTRONIC..... 241
- Speed adaptation, Route-based**..... 244
- Speed control**
 Active Distance Assist DISTRONIC..... 239
 Cruise control..... 237

- Speed rating**
Tires..... 420
- Start-off assist**
Drive Away Assist..... 287
Hill Start Assist..... 235
Optimized acceleration..... 180
- Start/stop button**
Parking the vehicle..... 220
Starting the vehicle..... 176
Switching on the power supply / vehicle..... 175
- Start/stop function**..... 185
- Starter battery**
charging, Remote Online..... 178
- Starting**
Remote Online..... 179
Start/stop button..... 176
- Starting assistance**..... 394
- Starting the engine**
Emergency operation mode..... 178
Remote Online..... 179
Start/stop button..... 176
- Starting-off aid**
Drive Away Assist..... 287
Hill Start Assist..... 235
Optimized acceleration..... 180
- Status display**
Front passenger air bag..... 45
Rear passenger compartment seat belt.... 45
- Steer Assist**
Active Steering Assist..... 246
STEER CONTROL..... 233
- STEER CONTROL**..... 233
- Steering**
Rear axle steering..... 184
- Steering wheel**
Adjusting electrically..... 114
Driver's air bag..... 57
Manually adjusting..... 113
Memory function..... 119
Steering wheel heater..... 115
- Steering wheel adjustments**..... 114
- Steering wheel heater**..... 115
- Steering wheel heating**
Decoupling from the seat heating..... 116
- Steering wheel paddle shifters**..... 199
- Stop and go**
ECO start/stop function..... 186
- Stopping**
Parking the vehicle..... 220
- Stowage areas**..... 122
- Stowage spaces**
Armrest (front)..... 122, 123
Center console (front)..... 122, 123
Door..... 122
Glove box..... 122
- Substances hazardous to health**..... 26
- sulfur content**..... 443
- Switch-off delay time**
Exterior..... 150
Interior..... 152
- Switching air-recirculation mode on/off**..... 164
- System settings**
MBUX reset function..... 323
Overview..... 319





T		
Tank capacity		
Fuel.....	444	
Reserve.....	444	
Tank filler cap / flap.....	201	
Technical data		
Information.....	437	
Radio regulations.....	439	
Specific absorption rate (SAR).....	439	
Vehicle dimensions.....	448	
Telediagnosis		
Diagnostic data.....	363	
Telediagnosics		
Transferred data.....	364	
Telemetry display.....	327	
Telephone, Smartphone		
Bluetooth®.....	346	
Connecting a mobile phone.....	346	
Menu.....	346	
Mobile phone usage.....	346	
Notes.....	343	
Notes on wireless charging (mobile phone).....	137	
Secure Simple Pairing.....	346	
Telephone menu overview.....	345	
Wirelessly charging a(mobile phone, front).....	138	
Temperature		
Adjusting.....	159, 160	
Temperature grade.....	417	
THERMATIC		
Air conditioning control panel.....	159	
THERMOTRONIC		
Air conditioning control panel.....	160	
Tie-down eyes.....	128	
TIN (Tire Identification Number).....	418	
Tire and Loading Information placard.....	413	
Tire information table.....	413	
Tire labeling		
Load index.....	420	
Load-bearing capacity.....	420	
Size designation.....	420	
Speed rating.....	420	
Temperature grade.....	417	
Tire Quality Grading.....	417	
Traction grade.....	417	
Tread wear grade.....	417	
Tire lettering		
Composition.....	420	
DOT, Tire Identification Number (TIN).....	418	
Maximum tire load.....	419	
Maximum tire pressure.....	420	
Tire pressure		
Checking.....	410	
Checking manually.....	409	
maximum.....	420	
Notes.....	406	
Restarting the tire pressure loss warning system.....	412	
Tire pressure loss warning system, function.....	412	
Tire pressure table.....	408	
TIREFIT kit.....	384	
Tire pressure loss warning system		
Function.....	412	
Restarting.....	412	
Tire pressure monitor		
Function.....	409	
Tire pressure monitoring system		
Restarting.....	411	































- Tire pressure table**..... 408
Tire Quality Grading..... 417
Tire sealant..... 384
Tire tread..... 405
Tire-change tool..... 428, 429
Tire-change tool kit..... 428, 429
TIREFIT kit, Tire inflation compressor
 Storage location..... 384
Tires
 Breakdown..... 382
 Checking..... 405
 Checking the temperature..... 410
 Checking the tire pressure manually..... 409
 Composition..... 420
 Definitions..... 423
 DOT, Tire Identification Number (TIN)..... 418
 Installing..... 433
 Labeling..... 417
 Load index..... 420
 Load-bearing capacity..... 420
 Maximum pressure..... 420
 Maximum tire load..... 419
 MOExtended..... 383
 Noise..... 405
 Notes on installing..... 425
 Removing..... 432
 Removing/installing hub cap..... 429
 Replacing..... 425, 429
 Restarting the tire pressure loss warn-
 ing system..... 412
 Rotating..... 428
 Selecting..... 425
 Size designation..... 420
 Snow chains..... 406
 Speed rating..... 420
 Storing..... 428
 Temperature grade..... 417
 Tire and Loading Information placard..... 413
 Tire pressure loss warning system,
 function..... 412
 Tire pressure table..... 408
 Tire Quality Grading..... 417
 TIREFIT kit..... 384
 Traction grade..... 417
 Tread wear grade..... 417
 Unusual handling characteristics..... 405
Toll system
 Debiting toll fees..... 332
Top Tether..... 68
Topographical compensation, Predictive
 headlamp range control..... 144
Torque (driver's display)..... 298
Touch Control
 Driver display..... 295
 Driver's display..... 296
 MBUX..... 310
Touch-sensitive controls..... 23
Touchscreen..... 310
Tow bar system
 Towing away..... 294
Tow-away protection..... 100
Tow-starting..... 401
Towing
 Towing methods..... 396, 397
Towing eye
 Storage location..... 400
Towing methods
 Both axles on the ground..... 398
 Overview..... 396, 397
Track Race..... 324

- Traction grade**..... 417
- Traffic information**..... 339
- Traffic Jam Assistant**..... 246
- Traffic light warning/display**..... 260
- Traffic Sign Assist**
- Function..... 260
 - Setting..... 264
- Trailer drawbar, Pulling/towing**..... 294
- Transmission position display**..... 196
- Transmission positions**
- DIRECT SELECT lever..... 196
- Transporting**
- Vehicle..... 399
- Tread wear grade**..... 417
- Trunk lid**
- Closing..... 85
 - Emergency release (from inside)..... 90
 - HANDS-FREE ACCESS..... 87
 - Limiter..... 90
 - Opening..... 84
 - Power closing function..... 85
 - Switching the separate locking feature on/off..... 89
- Turn signal indicator**..... 141
- Turn signals**..... 141
- Two-way radios**
- Frequencies..... 438
 - Installation..... 437
 - Transmission output..... 438
- U**
- Unfastening**..... 56
- Unlocking setting**..... 74
- Updates**..... 320
- USB port**
- Rear passenger compartment..... 136
 - Storage compartments (front)..... 122
- User profiles**
- Adding a user..... 317
 - Note..... 315
 - Selecting options..... 317
- V**
- Vehicle, Switching on the ignition**
- 48 V on-board electrical system..... 26
 - Activating, Remote Online..... 179
 - Activating/deactivating standby mode... 229
 - Correct use..... 32
 - Data storage..... 34
 - Diagnostics connection..... 30
 - Emergency key..... 82
 - Equipment..... 23
 - High-voltage on-board electrical system... 26
 - KEYLESS-GO..... 80
 - Limited Warranty..... 34
 - lock automatically (MMS)..... 82
 - Locking/unlocking (Digital Vehicle Key).... 77
 - Locking/unlocking (emergency key)..... 82
 - Locking/unlocking (from inside)..... 80
 - Lowering..... 434
 - Maintenance..... 25
 - Medical aids..... 32
 - Parking..... 220
 - Parking for an extended period..... 228
 - Problem notification..... 33
 - Pulling..... 294
 - QR code rescue card..... 34
 - Raising..... 430
 - Set collision detection..... 227
 - Standby mode function..... 228
 - Starting (Digital Vehicle Key)..... 177

- Starting (start/stop button)..... 176
 starting, emergency operation mode..... 178
 Stopping..... 220
 Switching off (start/stop button)..... 220
 Switching on (start/stop button)..... 175
 Towing away..... 396, 397
 Transporting..... 399
 Ventilating / comfort opening..... 92
- Vehicle cameras**..... 229
- Vehicle data**
- Display, MBUX..... 195
 - Displaying, DYNAMIC SELECT..... 195
 - Turning circle..... 448
 - Vehicle height..... 448
 - Vehicle length..... 448
 - Vehicle width..... 448
 - Weights..... 448
 - Wheelbase..... 448
- Vehicle dimensions**..... 448
- Vehicle emergency start**..... 401
- Vehicle equipment**..... 23
- Vehicle identification number**..... 439
- Vehicle identification plate**
- Model type..... 439
 - Paint code..... 439
 - VIN..... 439
- Vehicle interior**
- Cooling/heating (Remote Online)..... 178
- Vehicle key**..... 73
- Vehicle operation outside the USA or Canada**..... 24
- Vehicle sensors**..... 229
- Vehicle socket**
- Care..... 375
 - Emergency release of the socket flap..... 219
 - Indicator lamps..... 212
- Vehicle start**
- Emergency operation mode..... 178
 - Remote Online..... 179
 - Start/stop button..... 176
- Vehicle tool kit**
- TIREFIT kit..... 384
 - Towing eye..... 400
- Ventilating**..... 92
- Ventilation**..... 171
- Vents**
- Air vents..... 171
- VIN**
- Engine compartment..... 439
 - Identification plate..... 439
 - Seat..... 439
- Vision**
- Defrosting windows..... 164
- Voice assistant**
- Voice prompting..... 311

W

- Warning system**..... 99
- Warning triangle**..... 381
- Warning/indicator lamp**
-  ABS warning lamp..... 539
 -  Active Brake Assist warning lamp..... 542
 -  ATTENTION ASSIST warning lamp..... 541
 -  Brakes warning lamp (Canada only)..... 538

-  Brakes warning lamp (USA only)... 538
-  Brakes warning lamp (yellow) (Canada only)..... 537
-  Check Engine warning lamp..... 533
-  Coolant warning lamp (red)..... 531
-  Coolant warning lamp (yellow)..... 533
-  Distance warning lamp..... 541
-  Electric parking brake indicator lamp (red) (Canada only)..... 536
-  Electric parking brake indicator lamp (red) (USA only)..... 536
-  Electric parking brake indicator lamp (yellow)..... 536
-  Electrical malfunction warning lamp..... 530, 534
-  Engine operating temperature warning lamp..... 534
-  ESP® OFF warning lamp..... 540
-  ESP® warning lamp flashes..... 539
-  ESP® warning lamp lights up..... 540
-  Fuel reserve warning lamp flashes..... 534
-  Fuel reserve warning lamp lights up..... 535
-  Mercedes-Benz emergency call system warning lamp..... 543
-  Occupant presence reminder warning lamp (white)..... 528
-  Occupant presence reminder warning lamp (yellow)..... 529
-  Power steering warning lamp (red)..... 530
-  Power steering warning lamp (yellow)..... 530
-  RBS warning lamp (USA only)..... 537
-  Rear axle steering warning lamp (yellow)..... 531
-  Reduced warning lamp power..... 529
-  Restraint system warning lamp..... 527
-  Seat belt warning lamp flashes..... 528
-  Seat belt warning lamp lights up... 528
-  System malfunction warning lamp..... 529
-  Tire pressure monitoring system warning lamp flashes..... 543
-  Tire pressure monitoring system warning lamp lights up..... 544
-  Traffic Sign Assist warning lamp... 541
- Warning/indicator lamps**
- Driver's display..... 525
- PASSENGER AIR BAG..... 45
- Washer fluid**
- Topping up..... 369
- Windshield washer fluid..... 446
- Washing by hand**..... 373
- Water tank**..... 370
- Wear**
- Limited protection..... 53
- Weather information**..... 339
- Weight information**..... 439

- Wheel change**
 Installing a new wheel..... 433
 Lowering the vehicle..... 434
 Removing a wheel..... 432
 Removing/installing hub caps..... 429
- Wheel rotation**..... 428
- Wheels**
 Breakdown..... 382
 Care..... 375
 Checking..... 405
 Checking the tire pressure manually..... 409
 Checking the tire temperature..... 410
 Composition of the tire..... 420
 Definitions..... 423
 DOT, Tire Identification Number (TIN)..... 418
 Installing..... 433
 Load index..... 420
 Load-bearing capacity..... 420
 Maximum tire load..... 419
 Maximum tire pressure..... 420
 MOExtended..... 383
 Noise..... 405
 Notes on installing..... 425
 Removing..... 432
 Removing/installing hub cap..... 429
- Replacing..... 425, 429
 Rotating..... 428
 Selecting..... 425
 Size designation..... 420
 Snow chains..... 406
 Speed rating..... 420
 Storing..... 428
 Temperature grade..... 417
 Tire and Loading Information placard..... 413
 Tire labeling..... 417
 Tire pressure..... 406
 Tire pressure monitor..... 409
 Tire Quality Grading..... 417
 TIREFIT kit..... 384
 Traction grade..... 417
 Tread wear grade..... 417
 Unusual handling characteristics..... 405
- Wi-Fi**
 Setting up a hotspot..... 321
- Window**
 Rear window..... 98
 Roller sunblind..... 98
- Window curtain air bag**..... 57
- Windows**
 Care..... 375
 Convenience opening..... 92
 De-icing..... 162
 Opening with the SmartKey..... 92
 Opening/closing..... 90
 Removing mist..... 164
 Window films..... 375
- Windshield**
 De-icing..... 162
 Demisting..... 159, 160
- Windshield washer fluid**..... 446
- Windshield washer system**..... 369
- Windshield wipers**
 Activating/deactivating..... 152
 Replacing the wiper blades..... 152
 Replacing the wiper blades (windshield)..... 152
- Winter operation**
 Snow chains..... 406
- Wiper blades**
 Care..... 375
 Replacing (windshield)..... 152

Wipers..... 152

Wireless charging

Mobile phone (front)..... 138

Notes..... 137

Workout programs..... 111

Workshop..... 31

Z

Zero layer

Function..... 304

Overview..... 305